

Approximate Performance in Laboratory Tests
 Tensile Strength: 16500 N
 Direct Torque: 11 Nm
 Body Torque: 3.5 Nm
 Shear Strength: 3000 N

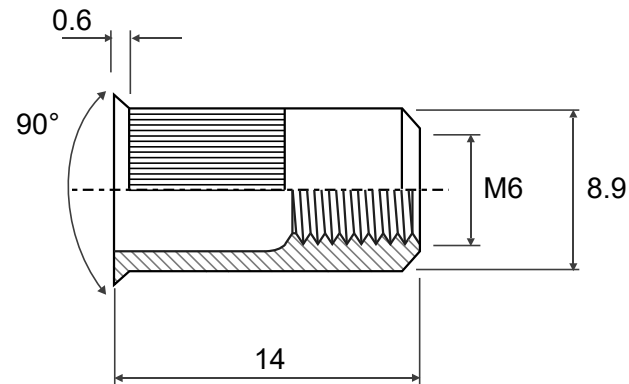

	Material		Customer Part No.	
	Finish		Web Ref No	