

Approximate Performance in Laboratory Tests

Tensile Strength: 6800 N
Direct Torque: 3 Nm
Body Torque: 0.8 Nm
Shear Strength: 1500 N

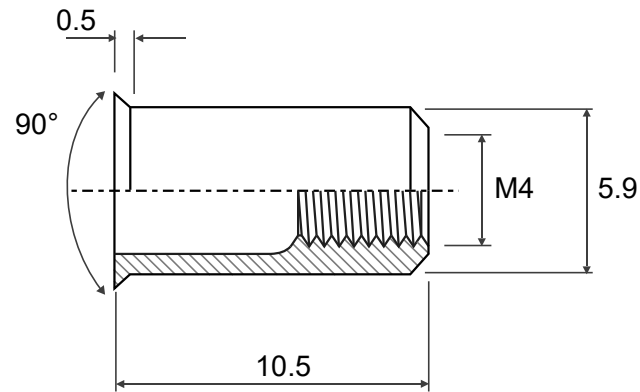

	Material		Customer Part No.	
	Finish		Web Ref No	