

12.8 - 12.9

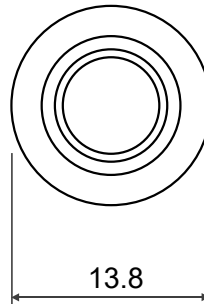

Approximate Performance in Laboratory Tests

Tensile Strength: 32000 N
Direct Torque: 32 Nm
Body Torque: 8.5 Nm
Shear Strength: 5000 N

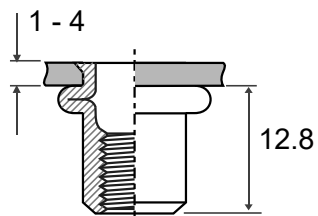
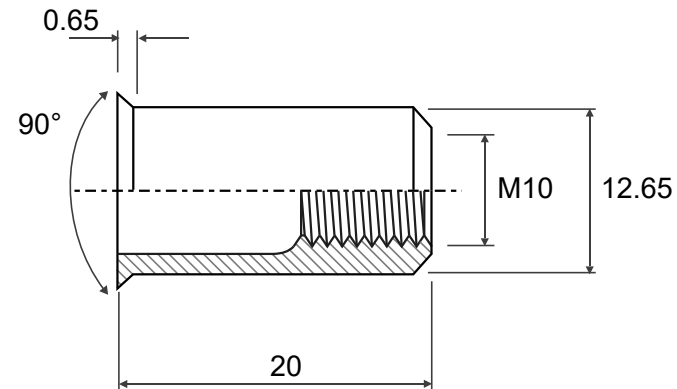

	Material		Customer Part No.	
	Finish		Web Ref No	