

Approximate Performance in Laboratory Tests

Tensile Strength: 16500 N
Direct Torque: 15 Nm
Body Torque: 4.5 Nm
Shear Strength: 3000 N

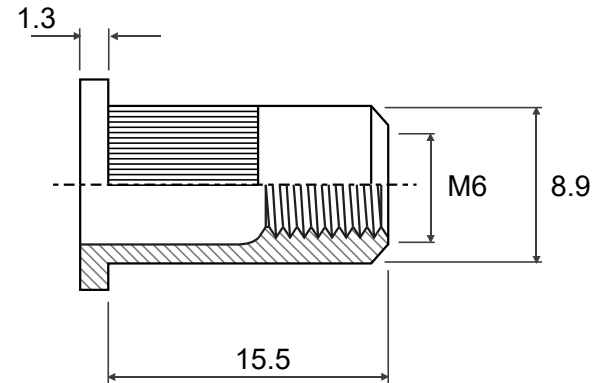

	Material		Customer Part No.	
	Finish		Web Ref No	