

Approximate Performance in Laboratory Tests

Tensile Strength: 25000 N
Direct Torque: 26 Nm
Body Torque: 4.5 Nm
Shear Strength: 4400 N

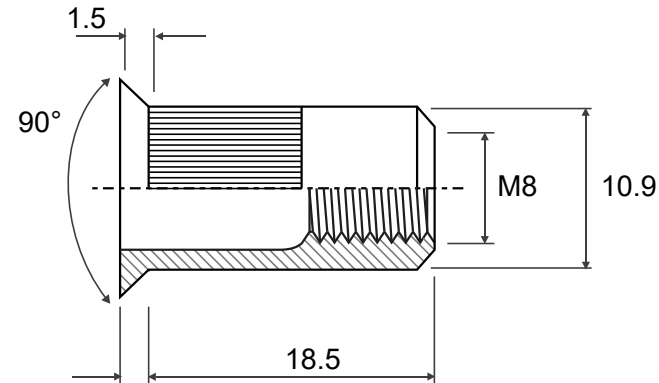

	Material		Customer Part No.	
	Finish		Web Ref No	