

REVISIONS					
P.	LTN	DESCRIPTION	DATE	DMN	APVD
B		REV PER ECO 18-019704	1-16-19	CT	DM

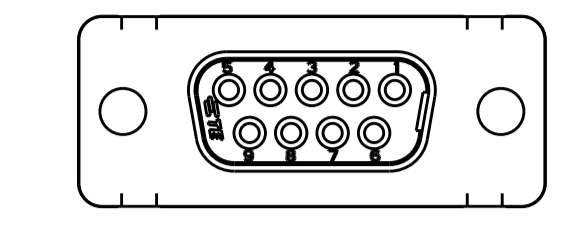

SIZE 1
SCALE 2:1

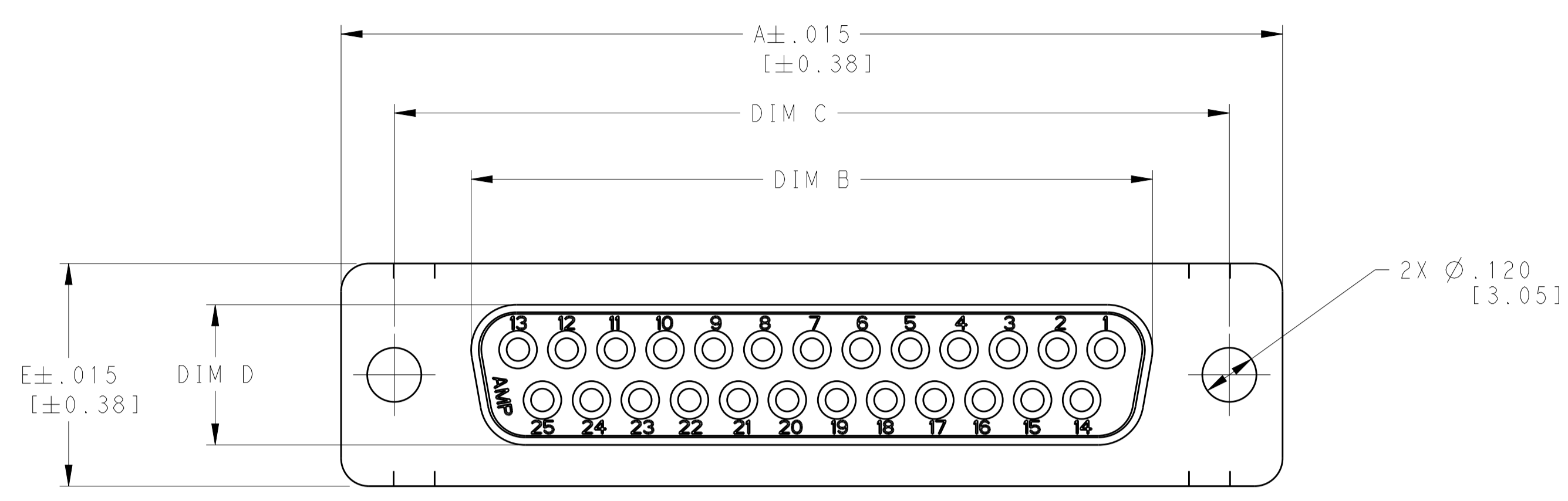
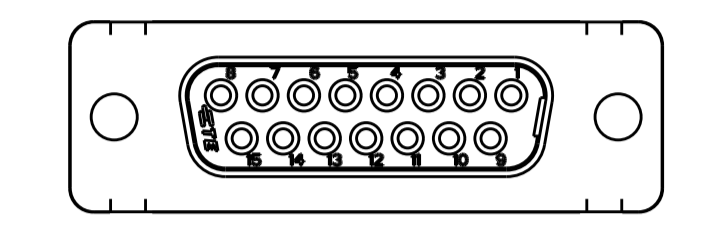

SIZE 2
SCALE 2:1

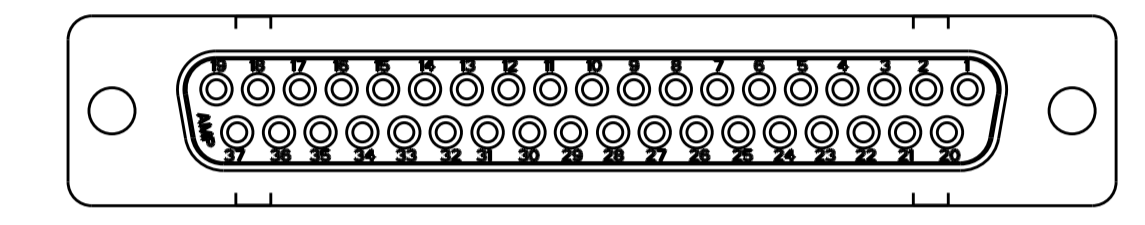

SIZE 4
SCALE 2:1

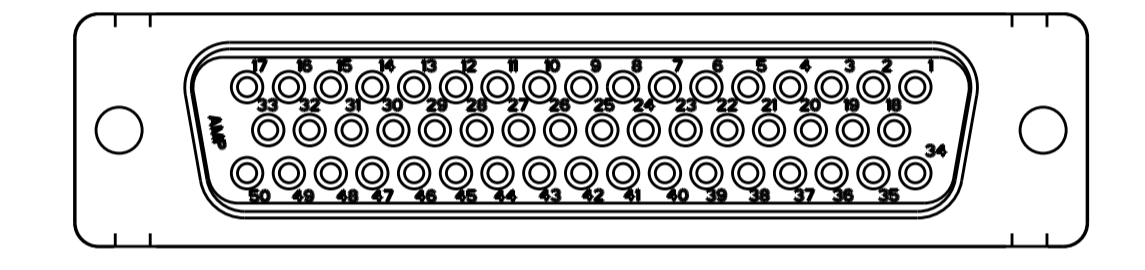

SIZE 5
SCALE 2:1

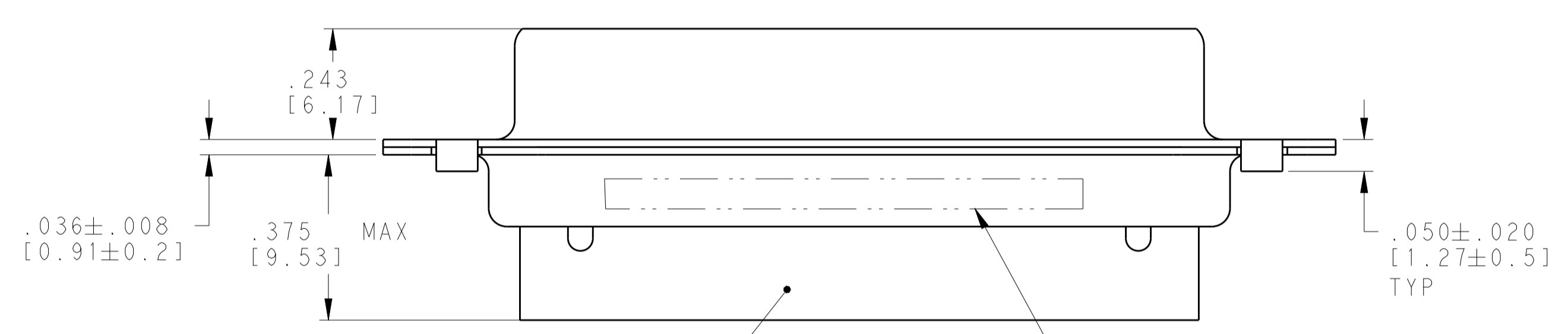

INSERT ASSEMBLY
MAT'L: PER MIL-DTL-24308

TE, TE PART NUMBER AND DATE CODE MARKED ON REAR SHELL, FAR SIDE

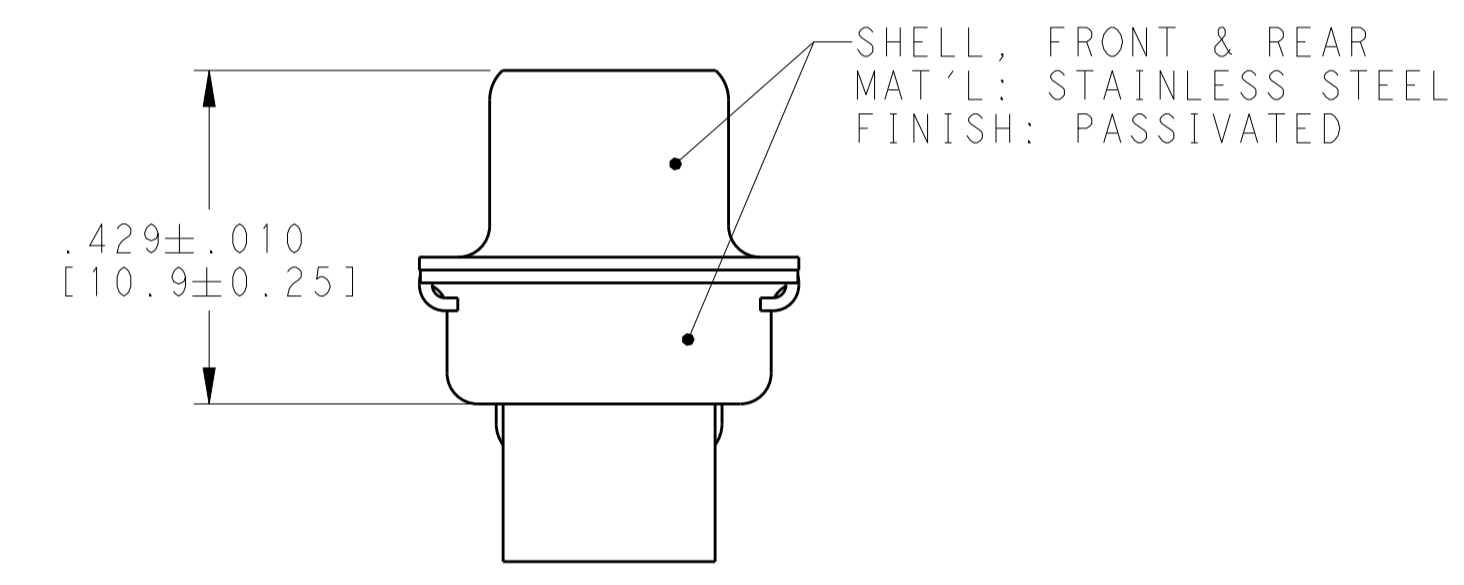

2335890-3 SHOWN

- THIS ASSEMBLY IS DESIGNED TO CONFORM TO THE LATEST ISSUE OF MIL-DTL-24308
 - METAL RETENTION CLIPS ARE INCLUDED IN INSERTS.
 - THIS RECEPTACLE WILL ACCEPT SIZE 20 SOCKET CONTACTS M39029/63-368 TE CONNECTIVITY PART NO. 205090-1. CONTACTS ARE NOT INCLUDED AND MUST BE ORDERED SEPARATELY.
- MARKED WITH .047-.062 HIGH CHARACTERS. FAR SIDE REFERS TO THE WIDE SIDE OF THE KEYSTONE. NEAR SIDE REFERS TO THE NARROW SIDE OF THE KEYSTONE. IF THE REAR SHELL IS TOO SMALL FOR TE, TE PART NUMBER AND DATE CODE, THEN SPLIT AS FOLLOWS:
 A: TE PART ON REAR SHELL, NEAR SIDE
 B: TE AND DATE CODE ON REAR SHELL, FAR SIDE

DATE CODE IS FOUR DIGITS, FIRST TWO DIGITS REFER TO THE YEAR AND SECOND TWO DIGITS REFER TO THE WEEK.

2335889-5	.605 [15.37]	.423 [10.74]	2.406 [61.11]	2.064 [52.43]	2.635 [66.93]	50	5	2335890-5
2335889-4	.494 [12.55]	.311 [7.90]	2.500 [63.50]	2.159 [54.84]	2.729 [69.32]	37	4	2335890-4
2335889-3	.494 [12.55]	.311 [7.90]	1.852 [47.04]	1.511 [38.38]	2.088 [53.03]	25	3	2335890-3
2335889-2	.494 [12.55]	.311 [7.90]	1.312 [33.32]	.971 [24.66]	1.541 [39.14]	15	2	2335890-2
2335889-1	.494 [12.55]	.311 [7.90]	.984 [24.99]	.643 [16.33]	1.213 [30.81]	9	1	2335890-1
TE MATING PART NUMBER	DIM E	DIM D	DIM C	DIM B	DIM A	NUMBER OF POSITIONS	SHELL SIZE	TE PART NO.

THIS DRAWING IS A CONTROLLED DOCUMENT.

DIMENSIONS: INCHES [mm]
 TOLERANCES UNLESS OTHERWISE SPECIFIED:
 0 PLC ±
 1 PLC ±
 2 PLC ±
 3 PLC ±.005 (0.13)
 4 PLC ±
 ANGLES ±
 FINISH ±

MATERIAL: -
 FINISH: -

DWG: C.C. THOMAS 21AUG2018
 CHK: D. MILLER 8-21-18
 APVD: D. MILLER 8-21-18
 NAME: RECEPTACLE ASSEMBLY, SIZE 1 THRU 5 SERIES 109, AMPLIMITE WITH STAINLESS STEEL SHELLS
 SIZE: A1
 CAGE CODE: 00779
 DRAWING NO: 2335890
 WEIGHT: -
 CUSTOMER DRAWING: -
 SCALE: 4:1
 SHEET: 1 OF 1
 REV: B

STE TE Connectivity