

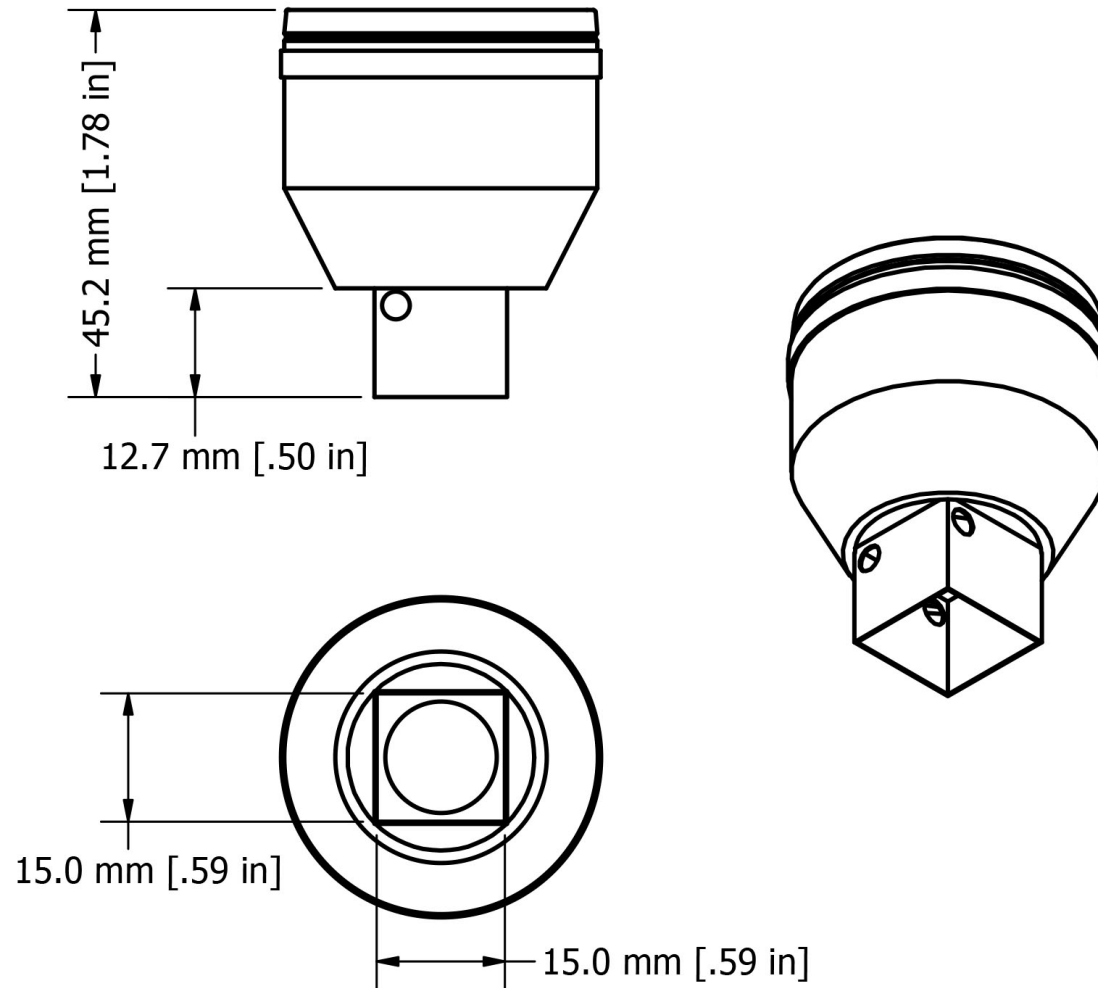

Made in the
United States of America
with Globally Sourced
Materials



All dimensions have a tolerance of ± 0.25 mm unless otherwise specified.

REFLOW NOZZLE, 15.0MM X 15.0MM

3651 WALNUT AVENUE, CHINO, CA 91710
PHONE: (909) 664-9980
WEBSITE: APR-Rework.com

**DRAWING
NUMBER**
NZA-150-150

DATE:
March
2019

APR