

2 CKT

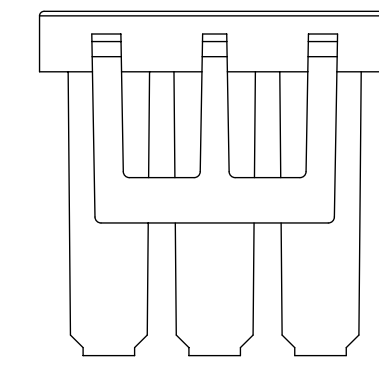

3 CKT

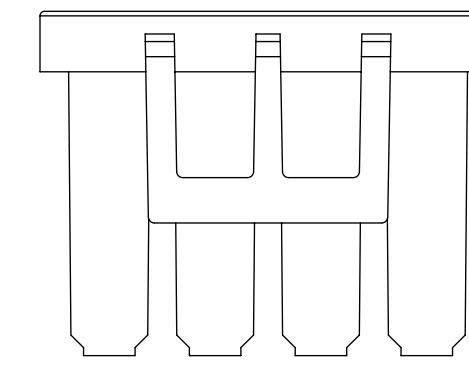

4 CKT

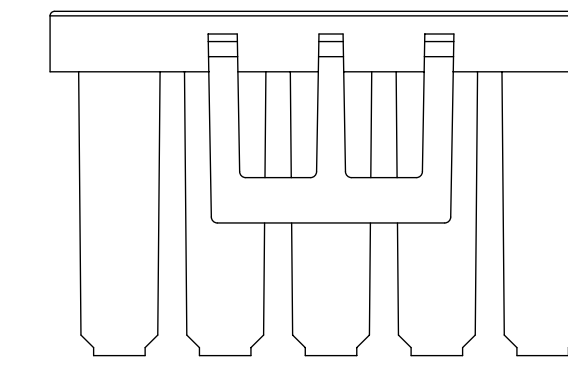

5 CKT

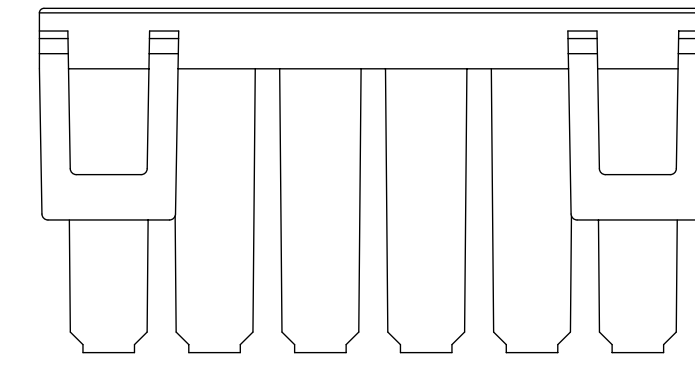
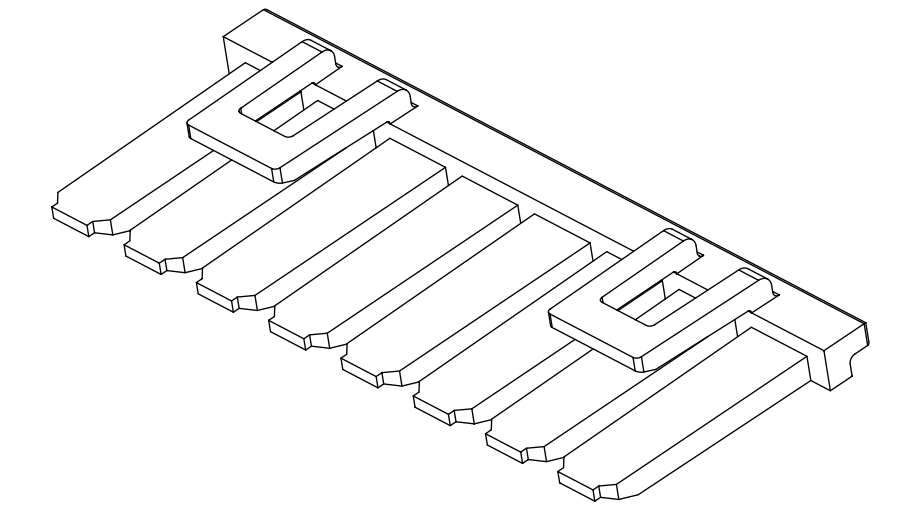

6 CKT

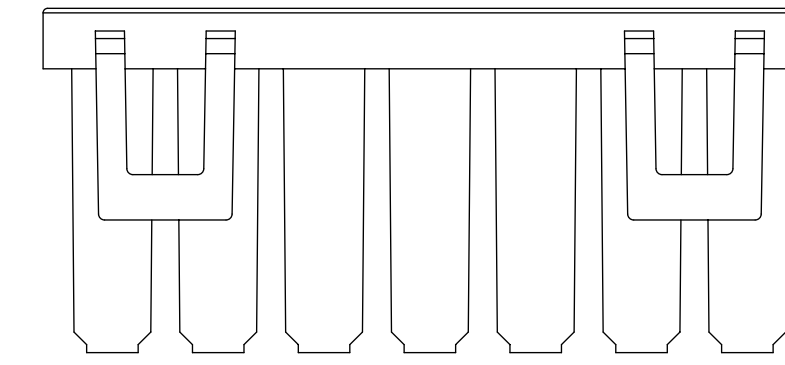

7 CKT

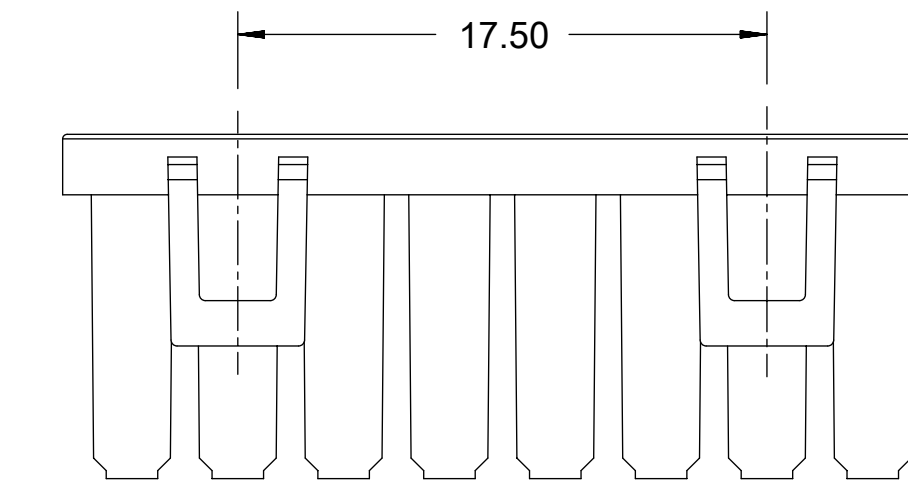

8 CKT

TPA

NOTES:

1. MATERIAL :
OPTION 1: NYLON GLOW WIRE BLACK
OPTION 2: NYLON GLOW WIRE NATURAL
2. PARTS TO BE PACKAGED PER PK-172323-0009
3. PRODUCT SPECIFICATION PS-172323-0001
4. PART USED WITH MOLEX RECEPTACLE HOUSING 172258 AND 172256
5. REFER TO AS-45499-001 FOR MOISTURING NYLON CONNECTOR PARTS
6. PARTS CONFORM TO CLASS "B" REQUIREMENTS OF COSMETIC SPECIFICATION PS-45499-002
7. APPLICATION SPECIFICATION: AS-172323-0001
8. MOLEX RECOMMENDS USING A NATURAL COLOR TPA FOR BLACK COLOR HOUSING AND A BLACK COLORED TPA FOR NATURAL COLORES HOUSINGS TO AID INSPECTION AFTER ASSEMBLY.

PART NO.	GW	COLOR	CIRCUIT SIZE	DIM B
172268-1002	GW	BLACK	2	8.08
172268-1003	GW	BLACK	3	11.58
172268-1004	GW	BLACK	4	15.08
172268-1005	GW	BLACK	5	18.58
172268-1006	GW	BLACK	6	22.08
172268-1007	GW	BLACK	7	25.58
172268-1008	GW	BLACK	8	29.20
172268-2002	GW	NATURAL	2	8.08
172268-2003	GW	NATURAL	3	11.58
172268-2004	GW	NATURAL	4	15.08
172268-2005	GW	NATURAL	5	18.58
172268-2006	GW	NATURAL	6	22.08
172268-2007	GW	NATURAL	7	25.58
172268-2008	GW	NATURAL	8	29.20

QUALITY SYMBOLS 	THIS DRAWING CONTAINS INFORMATION THAT IS PROPRIETARY TO MOLEX ELECTRONIC TECHNOLOGIES, LLC AND SHOULD NOT BE USED WITHOUT WRITTEN PERMISSION				
	EC NO: 103949 DRWN: PPerez03 CHKD: RHODGE REV APPR: RHODGE	GENERAL TOLERANCES (UNLESS SPECIFIED) DIMENSION UNITS: mm SCALE: 4:1		DRWN BY: DROSCA DATE: 2014/09/15	
		ANGULAR TOL ± ° 4 PLACES ± 3 PLACES ± 2 PLACES ± 0.25 1 PLACE ± 0.5 0 PLACES ±		CHKD BY: _____ DATE: _____	
		DRAFT WHERE APPLICABLE MUST REMAIN WITHIN DIMENSIONS		APPR BY: RHODGE DATE: 2014/09/25	
A4		DIMENSION UNITS: mm SCALE: 4:1 DRWN BY: DROSCA DATE: 2014/09/15 CHKD BY: _____ DATE: _____ APPR BY: RHODGE DATE: 2014/09/25		 ULTRA-FIT TPA, GW PRODUCT CUSTOMER DRAWING	
SERIES: 172268 MATERIAL NUMBER: SD-172268-0001 CUSTOMER: GENERAL MARKET		DRAWING SIZE: D THIRD ANGLE PROJECTION		DOCUMENT NUMBER: SD-172268-0001 DOC TYPE: PSD DOC PART: 000 SHEET NUMBER: 1 OF 1	

RELEASE STATUS	RELEASE DATE