

7	8
Rev.	DESCRIPTION

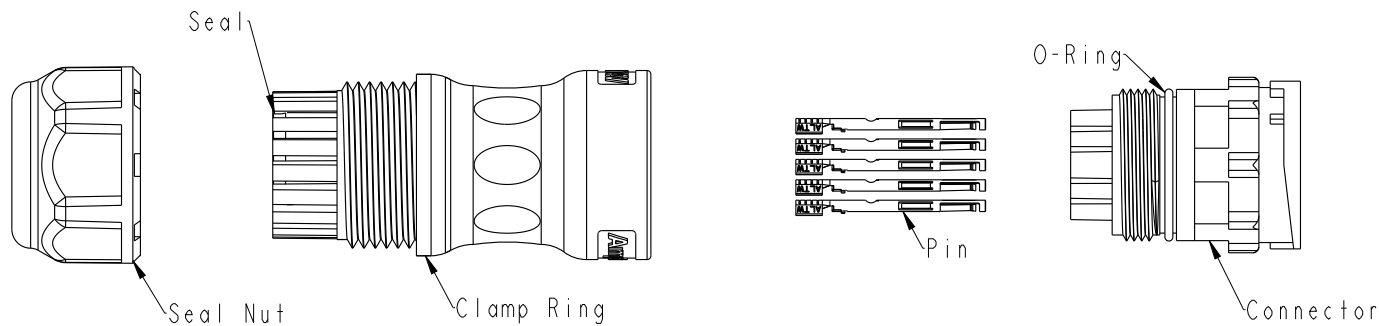

Material Specification:

- * Connector: Nylon+GF, Black.
- * Pins: Copper Alloy, Gold Plated.
- * Seal & O-Ring: Silicone, Gray.
- * UL Rated: UL 94V-0, fl.
- * RoHS Compliant.

Electrical Specification:

- * Contact Resistance: 10mΩ Max.
- * Insulation Resistance: 100MΩ Min.
- * Dielectric Withstand Voltage: 1,600 Vac.

Mechanical Specification:

- * Durability: 1000 Cycles.
- * Tensile strength: 10 kgf.
- * Wire Conductor:
 - 5A: 22AWG~20AWG
- * Wire Insulation OD:
 - 5A: 1.9mm Max.
- * Torque Force for Clamp Ring: 6~8 kgf-cm
- * Torque Force for Seal Nut: 6~8 kgf-cm

Environmental Specification:

- * Waterproof Rating: IP67(Mated)
- * Temperature Range: -40°C to 105°C.
- * Salt Spray: Mated, 1000 Hours.
- * Safety Compliance: UL 1977.

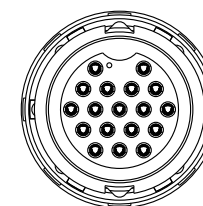
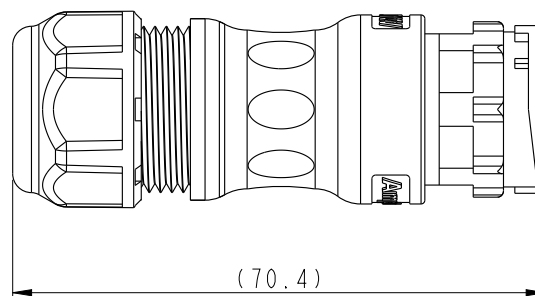
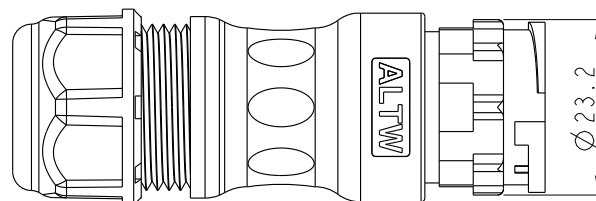

UNIT:mm

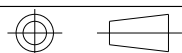

TOLERANCE

±0.5 mm

TITLE
Circular D-Size Field Installable
Cable Type M Conn

SCALE	8:5	SIZE	A4	SHEET	1	OF	2
REV.	A	WC-REV.	A.3	QC: Inspection item			

Amphenol LTW
安費諾亮泰企業股份有限公司

ITEM NO	DRAWN BY	DATE
DWG NO	CHECKED BY	DATE
CUSTOMER	APPROVED BY	DATE
ALTW	Peng	2018-12-15
	Mafei	2018-12-15
	Jerry	2018-12-15

THIS DOCUMENT IS SUBJECT TO CHANGE WITHOUT NOTICE. IT IS CONFIDENTIAL AND A PROPERTY OF Amphenol LTW. DISCLOSURE TO THIRD PARTY HAS TO BE AUTHORIZED BY Amphenol LTW.

Ordering Information:

ADD-18BMC-LL7XXX

O: For Data
P: For Power

P: With Pin
N: With Out Pin

A: With Red&Yellow&Blue Color Seal
S: With Red Color Seal, Cable OD 8.0~10.0mm.
M: With Yellow Color Seal, Cable OD 10.0~12.0mm.
L: With Blue Color Seal, Cable OD 12.0~14.0mm.

Contacts Gendor
M: Male Pin
F: Female Pin

Pin Assignments Front View
5A ;
18 Contacts(18)

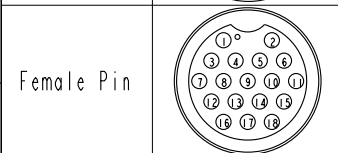
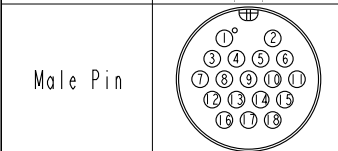

UNIT:mm
TOLERANCE
±0.5 mm

TITLE Circular D-Size Field Installable Cable Type M Conn			
SCALE 8:5	SIZE A4	SHEET 2 OF 2	
REV. A	WC-REV. A.3	QC: Inspection item	

Amphenol LTW
安費諾亮泰企業股份有限公司

ITEM NO	DRAWN BY Peng	DATE 2018-12-15
DWG NO ADD-18BMC-LL7XXX	CHECKED BY Mafei	DATE 2018-12-15
CUSTOMER ALTW	APPROVED BY Jerry	DATE 2018-12-15