

CIRCUIT	PART NO.	DIM A	COLOR
2	105411-1102	8.35	BLACK
4	105411-1104	12.05	
6	105411-1106	17.75	
8	105411-1108	23.45	
10	105411-1110	29.15	
12	105411-1112	34.85	

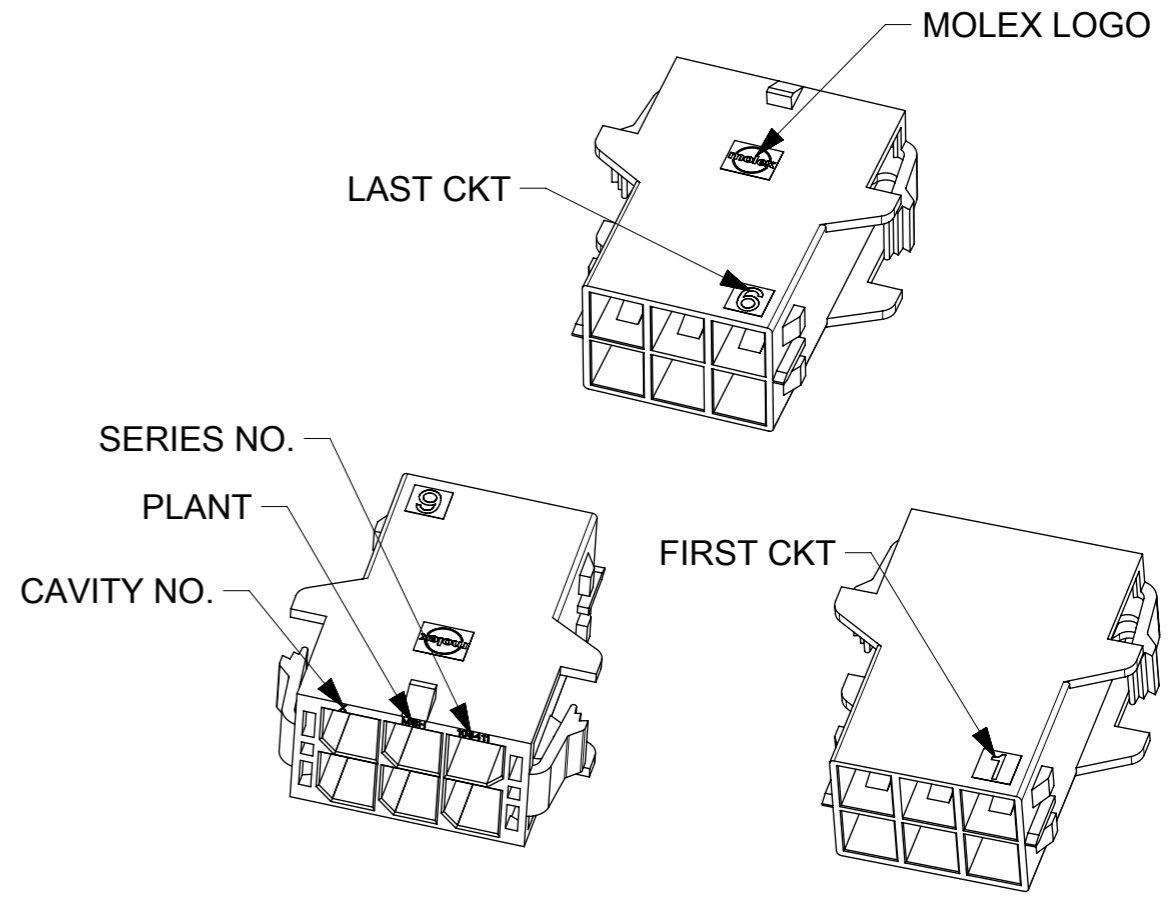
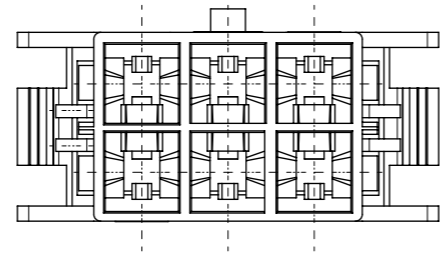
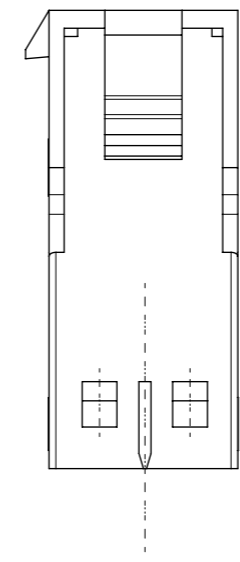
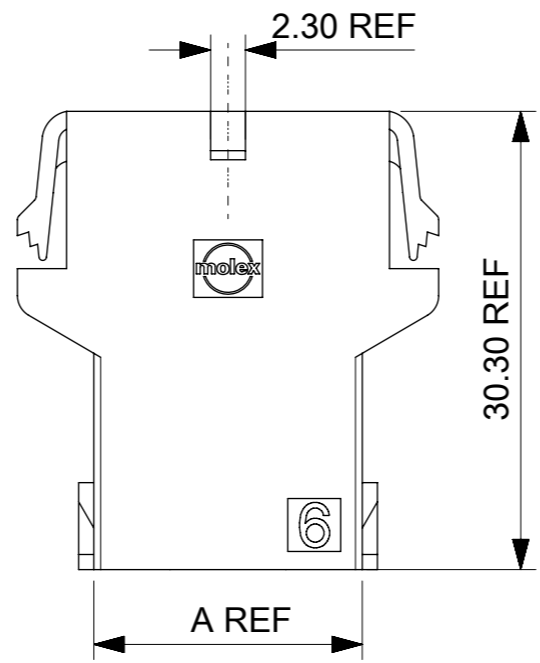
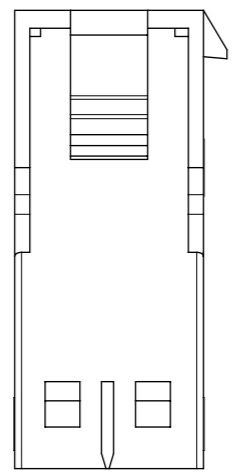
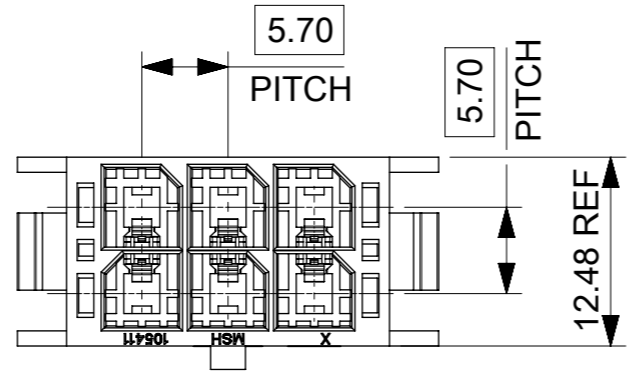

- NOTES:**
1. MATERIAL: NYLON,UL 94V-0 AND GLOW WIRE CAPABLE PER IEC60335-1. COLOR BLACK.
 2. PART MATES WITH MOLEX 171692/105415/105417/105418 SERIES.
 3. PRODUCT SPECIFICATION:PS-76823-100
 4. PAKCAGING SPECIFICATION: 1054110200
 5. APPLICATION SPECIFICATION:AS-76823-100

SYMBOLS		THIS DRAWING CONTAINS INFORMATION THAT IS PROPRIETARY TO MOLEX ELECTRONIC TECHNOLOGIES, LLC AND SHOULD NOT BE USED WITHOUT WRITTEN PERMISSION		CURRENT REV DESC:		molex			
DIMENSION UNITS		SCALE							MEGA-FIT PANEL MOUNT DR PLUG
mm				EC NO: 610353			DOCUMENT NUMBER		
GENERAL TOLERANCES (UNLESS SPECIFIED)				DRWN: YTIAN30 2019/01/09			1054110200		
ANGULAR TOL ± 0.5°				CHK'D: AYIN 2019/01/18			DOC TYPE DOC PART REVISION		
4 PLACES ±				APPR: AYIN 2019/01/18			PSD 000 C		
3 PLACES ±				INITIAL REVISION:			MATERIAL NUMBER		
2 PLACES ± 0.25				DRWN: YXZHENG 2016/12/15			105411		
1 PLACE ± 0.35				APPR: YXZHENG 2018/08/06			CUSTOMER		
0 PLACES ±				THIRD ANGLE PROJECTION			GENERAL MARKET		
DRAFT WHERE APPLICABLE MUST REMAIN WITHIN DIMENSIONS		THIRD ANGLE PROJECTION		DRAWING		SERIES		SHEET NUMBER	
		A3-SIZE		105411		SEE CHART		1 OF 2	

9 8 7 6 5 4 3 2 1

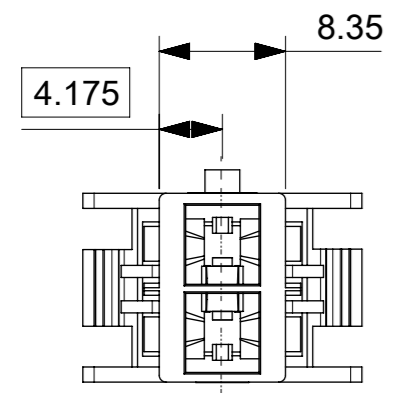

2 CIRCUITS

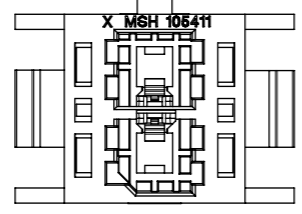

4 CIRCUITS

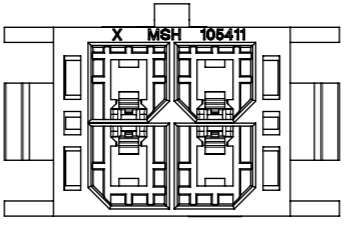

6 CIRCUITS

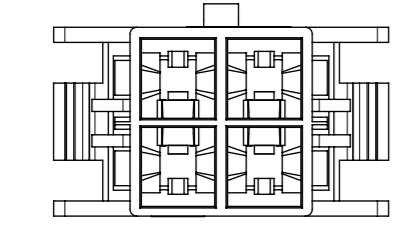

8 CIRCUITS

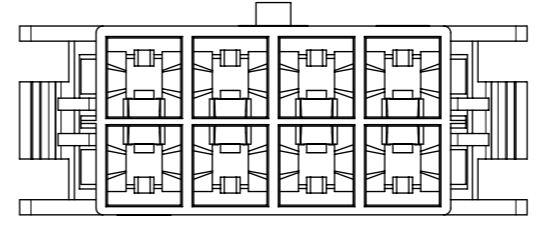

10 CIRCUITS

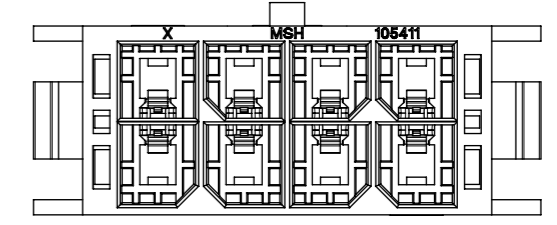

12 CIRCUITS

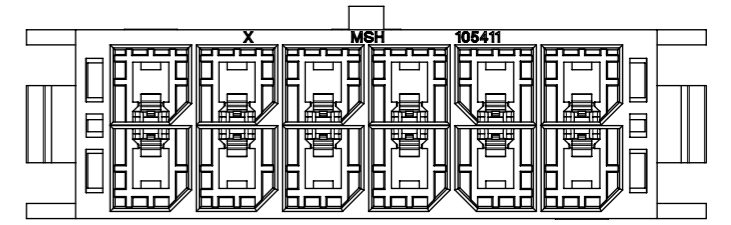
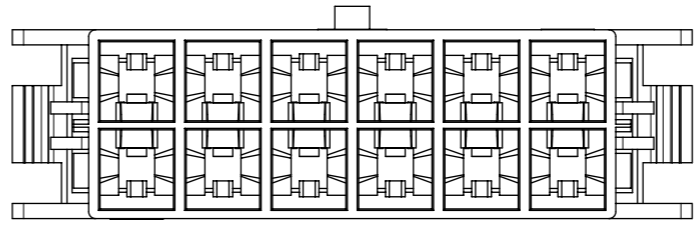
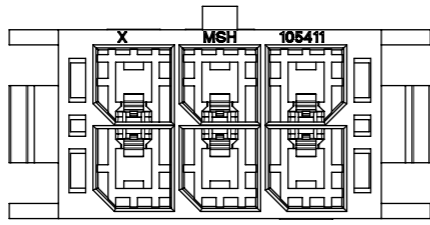
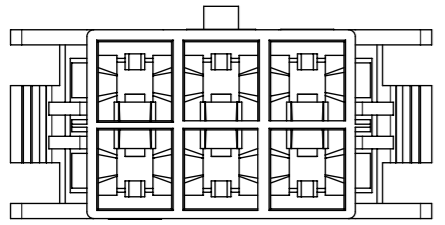

POLARIZATION LAYOUT

SYMBOLS		THIS DRAWING CONTAINS INFORMATION THAT IS PROPRIETARY TO MOLEX ELECTRONIC TECHNOLOGIES, LLC AND SHOULD NOT BE USED WITHOUT WRITTEN PERMISSION		CURRENT REV DESC:		molex			
DIMENSION UNITS		SCALE							MEGA-FIT PANEL MOUNT DR PLUG
mm				EC NO: 610353			DOCUMENT NUMBER		
GENERAL TOLERANCES (UNLESS SPECIFIED)				DRWN: YTIAN30 2019/01/09			1054110200		
ANGULAR TOL ± 0.5°				CHK'D: AYIN 2019/01/18			DOC TYPE DOC PART REVISION		
4 PLACES ±				APPR: AYIN 2019/01/18			PSD 000 C		
INITIAL REVISION:				DRWN: YXZHENG 2016/12/15			MATERIAL NUMBER		
2 PLACES ± 0.25				APPR: YXZHENG 2018/08/06			CUSTOMER		
1 PLACE ± 0.35				THIRD ANGLE PROJECTION			SHEET NUMBER		
0 PLACES ±				DRAWING			2 OF 2		
DRAFT WHERE APPLICABLE MUST REMAIN WITHIN DIMENSIONS				SERIES			GENERAL MARKET		
				A3-SIZE			SEE CHART		
				105411					

DOCUMENT STATUS	P1	RELEASE DATE	2019/01/18	01:36:37
-----------------	----	--------------	------------	----------

9 8 7 6 5 4 3 2 1