

3rd ANG PROJECTION

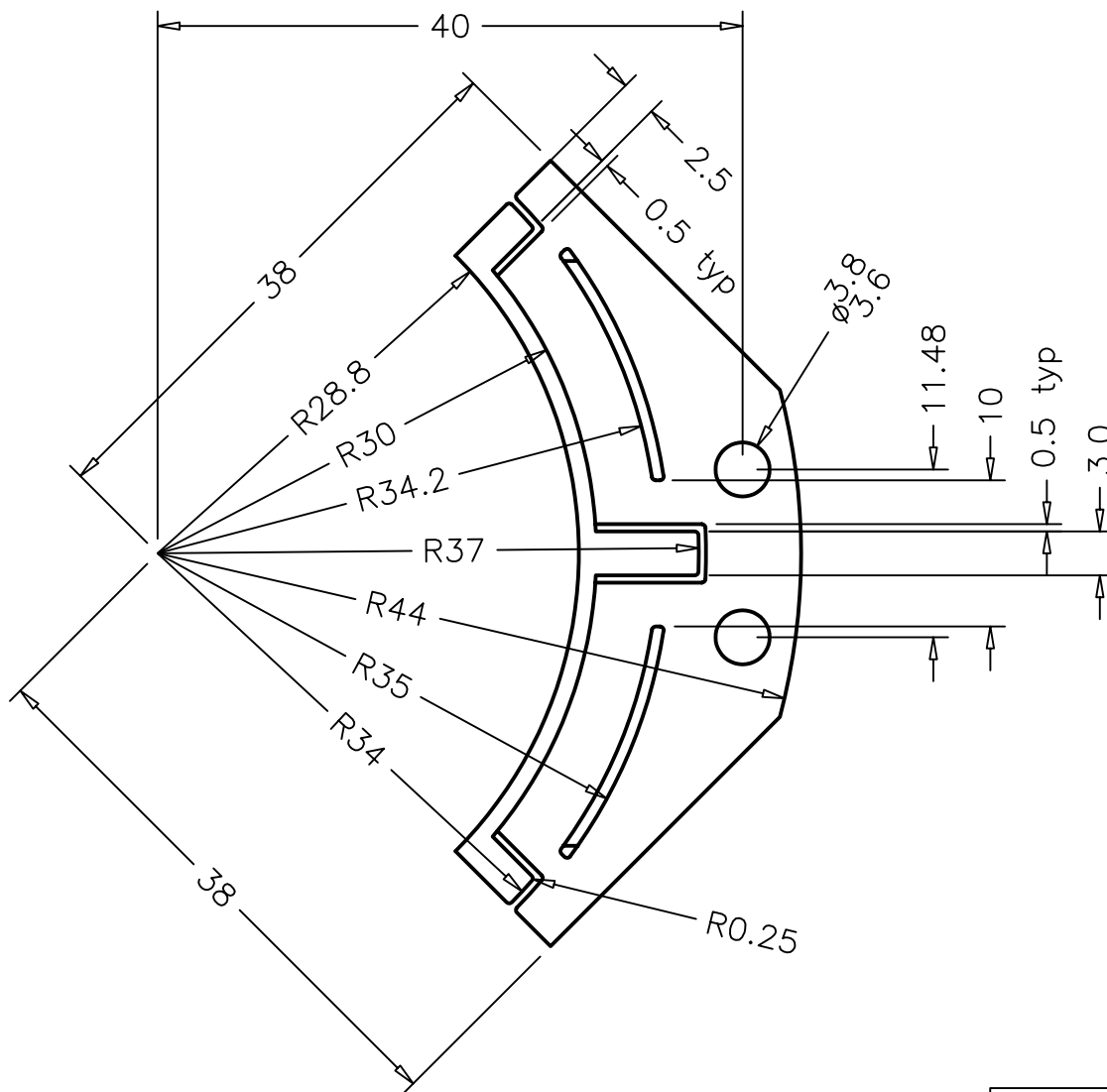

REV	DESCRIPTION	DATE	APPROVED
1	INITIAL ISSUE	090200	
2	MATL. SPEC. CHANGE	20/12/01	CN10
3	38 dimensions was 37	14/02/02	CN15

RICHCO ADDED RMS NO. 04/08/09

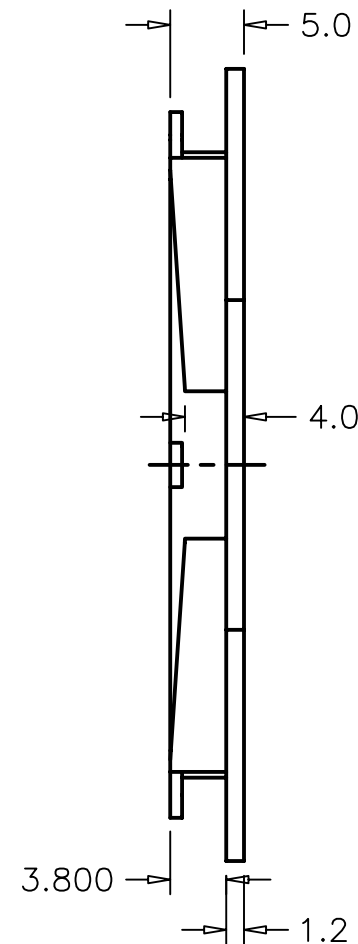

EFA04 34 P01 =
EFA04 34 001
(RMS-390) WITH
ADHESIVE PAD
(RMS-143)

EFA04 34 PR1 =
EFA04 34 001
(RMS-390) WITH
ADHESIVE PAD
(RMS-143) AND
RICHCO RIVET
(RMS-56)

EFA04 34 R01 =
EFA04 34 001
(RMS-390) WITH
RICHCO RIVET
(RMS-56)

NOTES: F.R. NYLON 6 RADIFLAM SAE100 OR EQUIVLANT

MATERIAL	SEE NOTES
FINISH	Flash Free
ICE No:	

THIS DOCUMENT CONTAINS PROPRIETARY INFORMATION WHICH SHALL NOT BE REPRODUCED, TRANSFERRED TO OTHER DOCUMENTS, DISCLOSED TO OTHERS USED FOR MANUFACTURING OR ANY OTHER PURPOSE WITHOUT THE WRITTEN AUTHORISATION OF EUROPLUS FIBRE OPTICS Ltd.

DESCRIPTION	Corner guide
-------------	--------------

ALL DIMS IN MM UNLESS STATED		GEN TOLS 0 = +/-0.5 0.0 = +/-0.3 0.00 = +/-0.1		EUROPLUS FIBRE OPTICS Europlus House, Thompson Drive, Anglia International Airpark, Rendlesham, Suffolk, IP12 2RQ. Tel: (01394) 445100 Fax: (01394) 445109			
DRAWN	CDD	DATE	090200	SIZE	FILE NAME	DWG. No	REV.
CHKD	CDD	DATE	090200		0434001	EFA04 34 001	3
DO NOT SCALE DRAWING				SCALE	2:1	SHEET 1 of 1	