

**UNCONTROLLED DOCUMENT**

NOTES:  
HOLE SIZE: .500  
MAXIMUM PANEL THICKNESS: .125  
MATERIAL: HEAT STABILIZED NYLON 6; BLACK

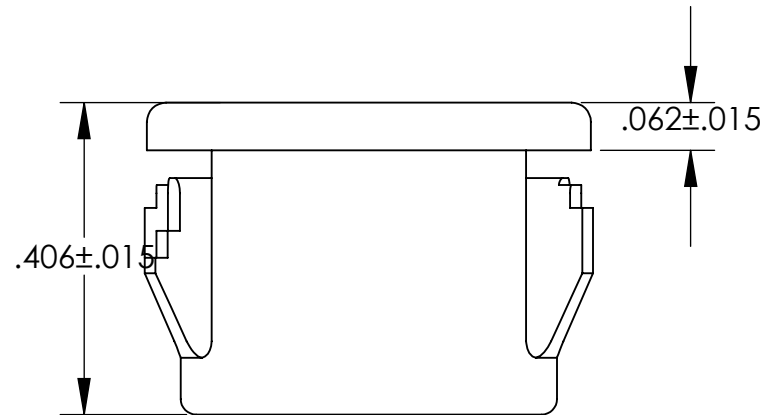
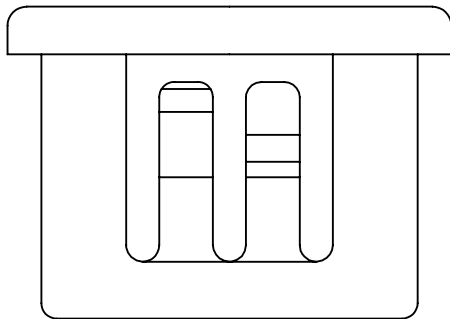
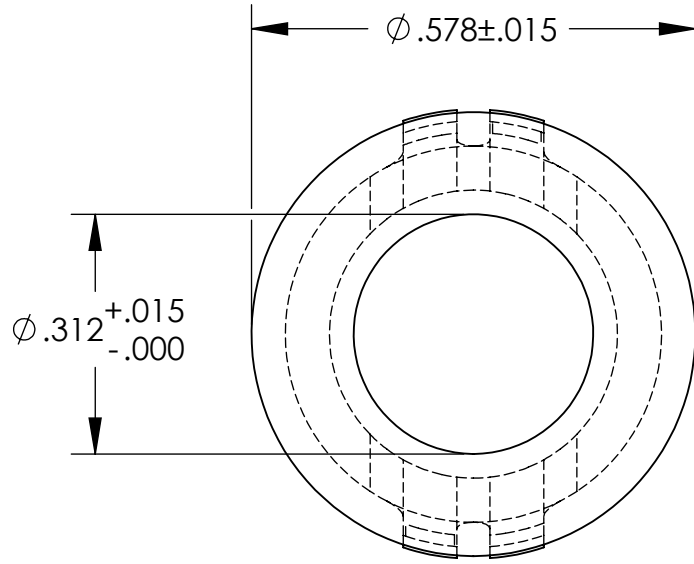

**TOLERANCES UNLESS NOTED**

- $\pm .005$  ON DIMENSIONS THRU  $.625$
- $\pm .008$  ON DIMENSIONS  $.626$  THRU  $1.000$
- $\pm .010$  ON DIMENSIONS  $1.001$  THRU  $1.500$
- $\pm .015$  ON DIMENSIONS LARGER THAN  $1.500$
- $\pm .015$  ON FRACTIONAL DIMENSIONS

**WE RESERVE THE RIGHT  
TO DISCONTINUE ITEMS,  
CHANGE SPECIFICATIONS  
OR DESIGN AT ANY TIME  
WITHOUT NOTICE AND  
WITHOUT INCURRING  
ANY OBLIGATIONS**

PROPERTY OF  
**MICRO PLASTICS INC.**

CATALOG DRAWING  
STANDARD INSULATING BUSHING  
MICRO P/N 22MP05005  
DWG. # 22MP05005  
FILE SERVER\ENG\WEB

MATERIAL: AS NOTED

DATE

SCALE  
4:1

**JDD**