

PART NO.

PSG01596

REVISIONS

ECN #	REV	DESCRIPTION	DRAWN	DATE	CHECKD	DATE	APPRVD	DATE
-	A	RELEASED	Venkat	11/2/08	Suresh	11/2/08	G. C	26/2/08

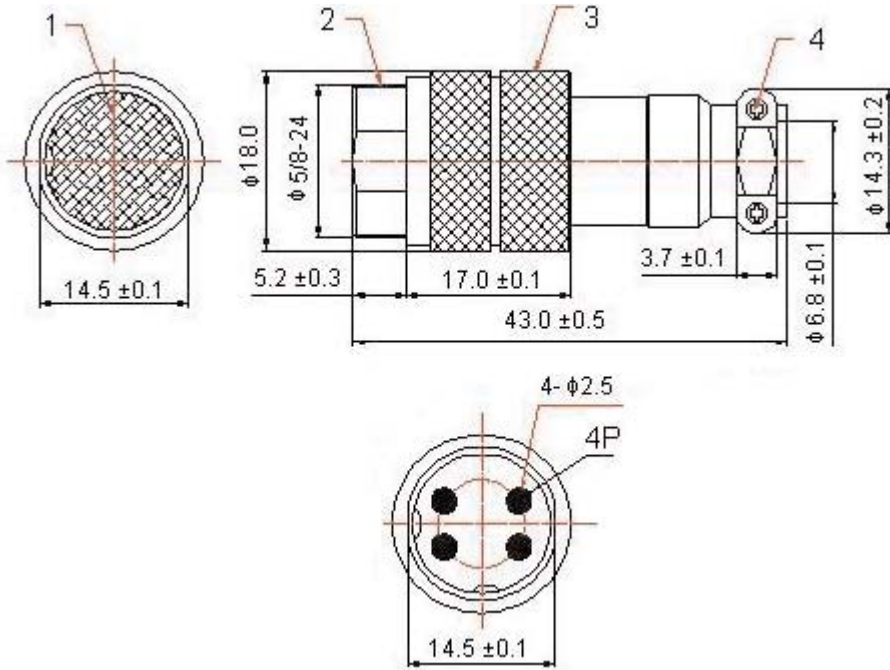

Dimensions : Millimetres

Specifications

Number	Designation	Material	Part Number
1	Dielectric	Bakelite	PSG01596
2	Female Part	Zn	
3	Body	Cu	
4	Screw	Fe	
5	Pin	Cu	

<http://www.farnell.com>

<http://www.newark.com>

<http://www.cpc.co.uk>

This data sheet and its contents (the "Information") belong to the Premier Farnell Group (the "Group") or are licensed to it. No licence is granted for the use of it other than for information purposes in connection with the products to which it relates. No licence of any intellectual property rights is granted. The Information is subject to change without notice and replaces all data sheets previously supplied. The Information supplied is believed to be accurate but the Group assumes no responsibility for its accuracy or completeness, any error in or omission from it or for any use made of it. Users of this data sheet should check for themselves the Information and the suitability of the products for their purpose and not make any assumptions based on information included or omitted. Liability for loss or damage resulting from any reliance on the Information or use of it (including liability resulting from negligence or where the Group was aware of the possibility of such loss or damage arising) is excluded. This will not operate to limit or restrict the Group's liability for death or personal injury resulting from its negligence. SPC pro-SIGNAL is the registered trademark of the Group. © Premier Farnell plc 2008.

**TOLERANCES:**  
**UNLESS OTHERWISE SPECIFIED, DIMENSIONS ARE FOR REFERENCE PURPOSES ONLY.**

<b>DRAWN BY:</b>	<b>DATE:</b>
Venkat	11/02/08
<b>CHECKED BY:</b>	<b>DATE:</b>
Suresh	11/02/08
<b>APPROVED BY:</b>	<b>DATE:</b>
G.Cook	26/02/08

**DRAWING TITLE:**

**Multipole Plug- 4 Way**

<b>SIZE</b> A	<b>DWG NO.</b>	<b>ELECTRONIC FILE</b> 1280762_DWG	<b>REV</b> A
<b>SCALE:</b> NTS	<b>U.O.M.:</b> mm	<b>SHEET:</b> 1 OF 1	