



PART NO.

TLL Series

REVISIONS

| ECN # | REV | DESCRIPTION | DRAWN | DATE | CHECKD | DATE | APPRVD | DATE |
|-------|-----|-------------|-------|---------|--------|---------|--------|------|
| - | A | RELEASED | Veena | 28/1/05 | Shashi | 28/1/05 | NK | |

TACT With LED Illumination

Features:

- Sharp click with positive tactile feed-back.
- Ultraminiature and light weight.
- Contact moulding prevents flux build-up enabling auto-dipping.

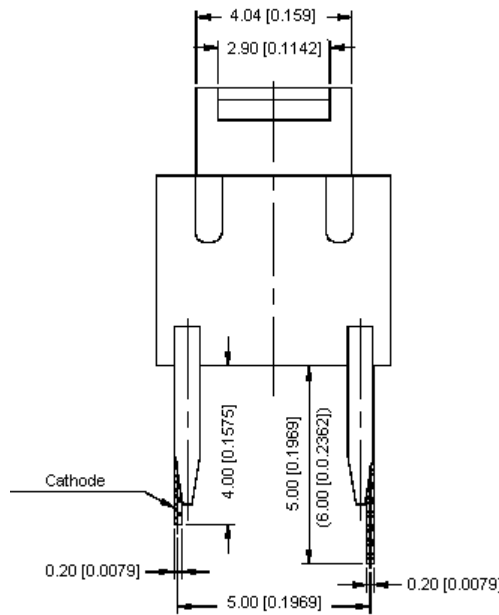
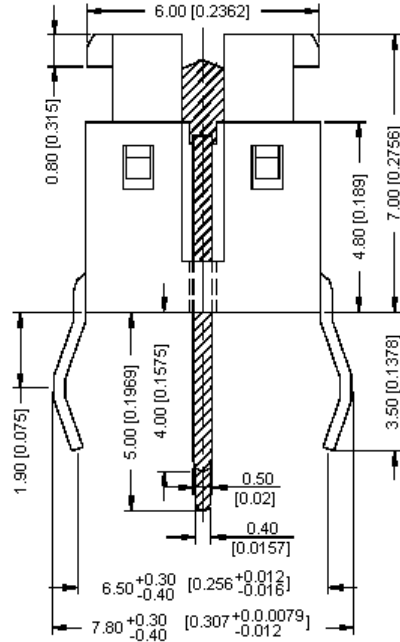
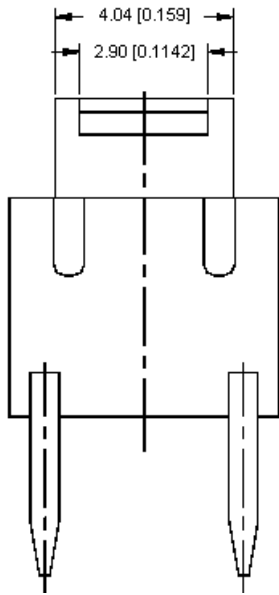
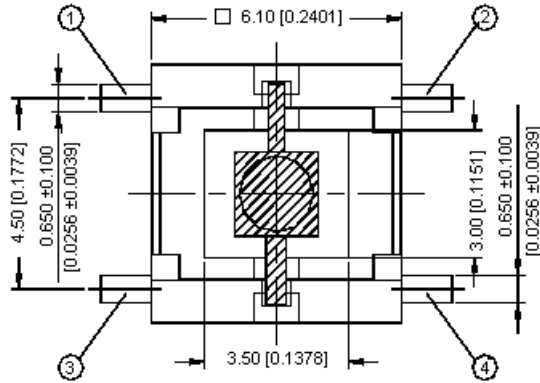

Dimensions : Millimetres (Inches)

This data sheet and its contents (the "Information") belong to the Premier Farnell Group (the "Group") or are licensed to it. No licence is granted for the use of it other than for information purposes in connection with the products to which it relates. No licence of any intellectual property rights is granted. The Information is subject to change without notice and replaces all data sheets previously supplied. The Information supplied is believed to be accurate but the Group assumes no responsibility for its accuracy or completeness, any error in or omission from it or for any use made of it. Users of this data sheet should check for themselves the Information and the suitability of the products for their purpose and not make any assumptions based on information included or omitted. Liability for loss or damage resulting from any reliance on the Information or use of it (including liability resulting from negligence or where the Group was aware of the possibility of such loss or damage arising) is excluded. This will not operate to limit or restrict the Group's liability for death or personal injury resulting from its negligence. MULTICOMP is the registered trademark of the Group. © Premier Farnell plc 2004.

TOLERANCES:

UNLESS OTHERWISE SPECIFIED, DIMENSIONS ARE FOR REFERENCE PURPOSES ONLY.

| | |
|--------------|----------|
| DRAWN BY: | DATE: |
| Veena | 28/01/05 |
| CHECKED BY: | DATE: |
| Shashi | 28/01/05 |
| APPROVED BY: | DATE: |

| | | | |
|---|---------------------|-----------------|-----|
| DRAWING TITLE: | | | |
| TLL Series - Tact with LED Illumination | | | |
| SIZE | DWG NO. | ELECTRONIC FILE | REV |
| A | M1000000199 | 47885_DWG | |
| SCALE: NTS | U.O.M.: mm (Inches) | SHEET: 1 OF 4 | |



PART NO.

TLL Series

REVISIONS

| ECN # | REV | DESCRIPTION | DRAWN | DATE | CHECKD | DATE | APPRVD | DATE |
|-------|-----|-------------|-------|---------|--------|---------|--------|------|
| - | A | RELEASED | Veena | 28/1/05 | Shashi | 28/1/05 | NK | |

Specifications:

Mechanical:

Operation Force : 160 ±50gf TL(L)-62.
 Stroke : 0.20 +/-0.10mm.
 Operation Temperature : -25°C to +70°C.
 Storage Temperature : -30°C to +80°C.

Electrical:

Electrical Life : 200,000 cycle minimum.
 Rating : 50mA, 12V dc.
 Contact Resistance : 100mΩ maximum.
 Insulation Resistance : 100MΩ maximum 500V dc.
 Dielectric Strength : 250V ac/minute.
 Contact arrangement : SPST.

Materials:

Contact Disc : Stainless steel.
 Terminal : Brass with Silver plating.
 Base : LCP high-temperature thermoplastic.
 Colour : Black.
 Stem : NYLON high-temperature. Thermoplastic.
 Colour : Brown.

PCB Layout

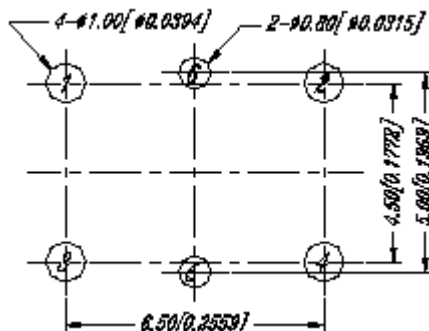

Circuit Diagram

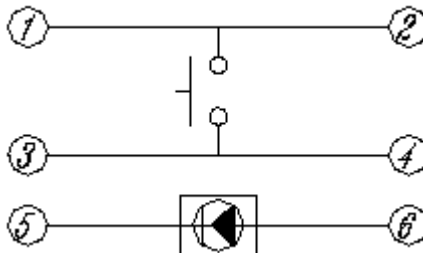

Soldering Process:

Wave Soldering : Recommended solder temperature at 500°F(260°C) maximum 5 Seconds.
 Hand Soldering : Use a soldering iron of 30 watts, Controlled at 608°F (320°C) approximately 2 seconds.

This data sheet and its contents (the "Information") belong to the Premier Farnell Group (the "Group") or are licensed to it. No licence is granted for the use of it other than for information purposes in connection with the products to which it relates. No licence of any intellectual property rights is granted. The Information is subject to change without notice and replaces all data sheets previously supplied. The Information supplied is believed to be accurate but the Group assumes no responsibility for its accuracy or completeness, any error in or omission from it or for any use made of it. Users of this data sheet should check for themselves the Information and the suitability of the products for their purpose and not make any assumptions based on information included or omitted. Liability for loss or damage resulting from any reliance on the Information or use of it (including liability resulting from negligence or where the Group was aware of the possibility of such loss or damage arising) is excluded. This will not operate to limit or restrict the Group's liability for death or personal injury resulting from its negligence. MULTICOMP is the registered trademark of the Group. © Premier Farnell plc 2004.

TOLERANCES:

UNLESS OTHERWISE SPECIFIED, DIMENSIONS ARE FOR REFERENCE PURPOSES ONLY.

| | |
|---------------------|--------------|
| DRAWN BY: | DATE: |
| Veena | 28/01/05 |
| CHECKED BY: | DATE: |
| Shashi | 28/01/05 |
| APPROVED BY: | DATE: |

| | | | |
|--|--------------------|----------------------------|----------------------|
| DRAWING TITLE: | | | |
| TLL Series - Tact with LED Illumination | | | |
| SIZE | DWG NO. | ELECTRONIC FILE | REV |
| A | M1000000199 | 47885_DWG | |
| SCALE: NTS | | U.O.M.: mm (Inches) | SHEET: 2 OF 4 |



PART NO.

TLL Series

REVISIONS

| ECN # | REV | DESCRIPTION | DRAWN | DATE | CHECKD | DATE | APPRVD | DATE |
|-------|-----|-------------|-------|---------|--------|---------|--------|------|
| - | A | RELEASED | Veena | 28/1/05 | Shashi | 28/1/05 | NK | |
| | | | | | | | | |

Specification Table

| Led Colour | Part Number |
|------------|-------------|
| Red | TLL-62BR |
| Yellow | TLL-62BY |
| Green | TLL-62BG |

Part Number Explanation

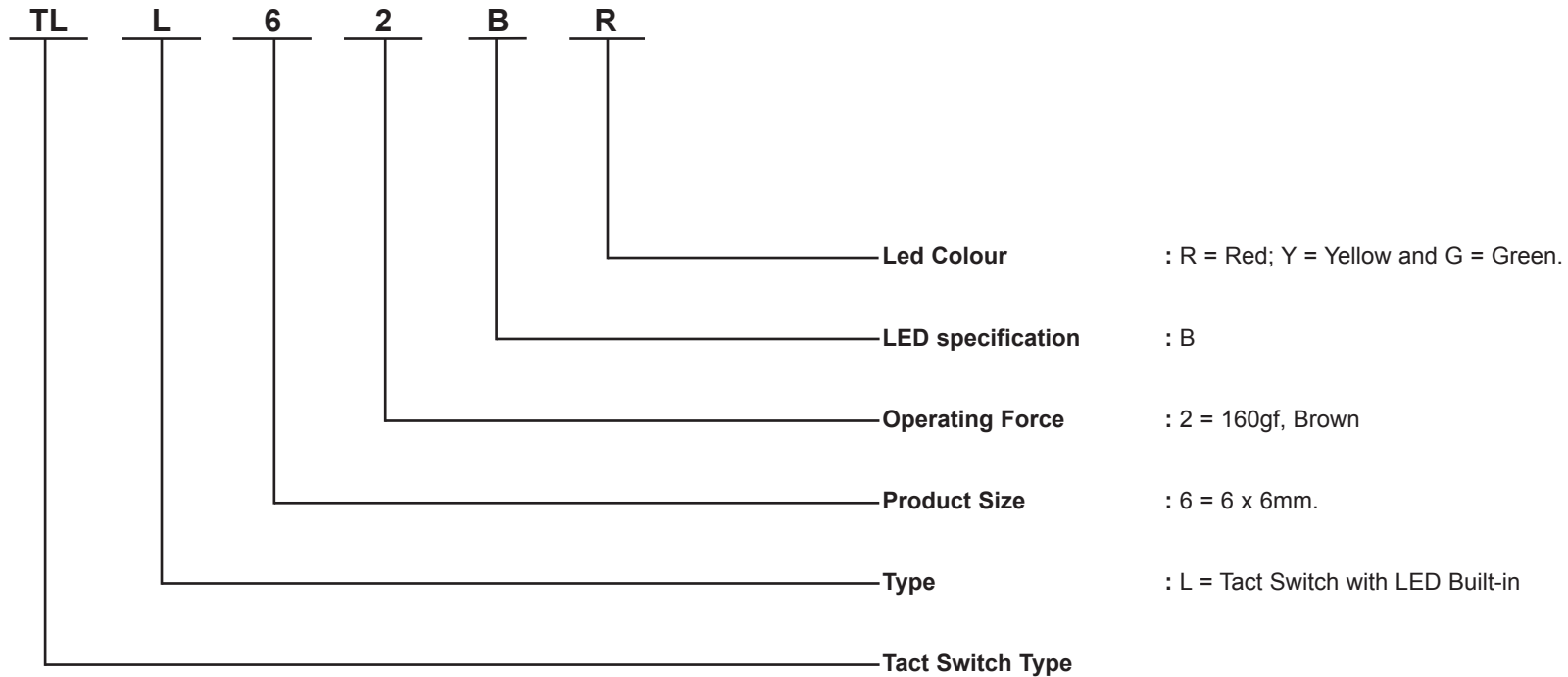

This data sheet and its contents (the "Information") belong to the Premier Farnell Group (the "Group") or are licensed to it. No licence is granted for the use of it other than for information purposes in connection with the products to which it relates. No licence of any intellectual property rights is granted. The Information is subject to change without notice and replaces all data sheets previously supplied. The Information supplied is believed to be accurate but the Group assumes no responsibility for its accuracy or completeness, any error in or omission from it or for any use made of it. Users of this data sheet should check for themselves the Information and the suitability of the products for their purpose and not make any assumptions based on information included or omitted. Liability for loss or damage resulting from any reliance on the Information or use of it (including liability resulting from negligence or where the Group was aware of the possibility of such loss or damage arising) is excluded. This will not operate to limit or restrict the Group's liability for death or personal injury resulting from its negligence. MULTICOMP is the registered trademark of the Group. © Premier Farnell plc 2004.

TOLERANCES:
UNLESS OTHERWISE SPECIFIED, DIMENSIONS ARE FOR REFERENCE PURPOSES ONLY.

| | |
|---------------------|--------------|
| DRAWN BY: | DATE: |
| Veena | 28/01/05 |
| CHECKED BY: | DATE: |
| Shashi | 28/01/05 |
| APPROVED BY: | DATE: |
| | |

| | | | |
|--|--------------------|----------------------------|----------------------|
| DRAWING TITLE: | | | |
| TLL Series - Tact with LED Illumination | | | |
| SIZE | DWG NO. | ELECTRONIC FILE | REV |
| A | M1000000199 | 47885_DWG | |
| SCALE: NTS | | U.O.M.: mm (Inches) | SHEET: 3 OF 4 |



PART NO.

TLL Series

REVISIONS

| ECN # | REV | DESCRIPTION | DRAWN | DATE | CHECKD | DATE | APPRVD | DATE |
|-------|-----|-------------|-------|---------|--------|---------|--------|------|
| - | A | RELEASED | Veena | 28/1/05 | Shashi | 28/1/05 | NK | |

Notes:

International Sales Offices:

- AUSTRALIA - Farnell InOne**
Tel No: ++ 61 2 9645 8888
Fax No: ++ 61 2 9644 7898
- AUSTRIA - Farnell InOne**
Tel No: ++ 43 662 2180 680
Fax No: ++ 43 662 2180 670
- BELGIUM - Farnell InOne**
Tel No: ++ 32 3 475 2810
Fax No: ++ 32 3 227 3648
- BRAZIL - Farnell-Newark InOne**
Tel No: ++ 55 11 4066 9400
Fax No: ++ 55 11 4066 9410
- CHINA - Farnell-Newark InOne**
Tel No: ++86 10 6238 5152
Fax No: ++86 10 6238 5022
- DENMARK - Farnell InOne**
Tel No: ++ 45 44 53 66 44
Fax No: ++ 45 44 53 66 06
- ESTONIA - Farnell InOne**
Tel No: ++ 358 9 560 7780
Fax No: ++ 358 9 345 5411
- FINLAND - Farnell InOne**
Tel No: ++ 358 9 560 7780
Fax No: ++ 358 9 345 5411
- FRANCE - Farnell InOne**
Tel No: ++ 33 474 68 99 99
Fax No: ++ 33 474 68 99 90
- GERMANY - Farnell InOne**
Tel No: ++ 49 89 61 39 39 39
Fax No: ++ 49 89 613 59 01
- HONG KONG - Farnell-Newark InOne**
Tel No: ++ 852 2268 9888
Fax No: ++ 852 2268 9899
- IRELAND - Farnell InOne**
Tel No: ++ 353 1 830 9277
Fax No: ++ 353 1 830 9016
- ITALY - Farnell InOne**
Tel No: ++ 39 02 93 995 200
Fax No: ++ 39 02 93 995 300
- MALAYSIA - Farnell-Newark InOne**
Tel No: ++ 60 3 7873 8000
Fax No: ++ 60 3 7873 7000
- NETHERLANDS - Farnell InOne**
Tel No: ++ 31 30 241 7373
Fax No: ++ 31 30 241 7333
- NORWAY - Farnell InOne**
Tel No: ++ 45 44 53 66 66
Fax No: ++ 45 44 53 66 02
- PORTUGAL - Farnell InOne**
Tel No: ++ 34 93 475 8804
Fax No: ++ 34 93 474 5288
- SINGAPORE - Farnell-Newark InOne**
Tel No: ++ 65 6788 0200
Fax No: ++ 65 6788 0300
- SPAIN - Farnell InOne**
Tel No: ++ 34 93 475 8805
Fax No: ++ 34 93 474 5107
- SWEDEN - Farnell InOne**
Tel No: ++ 46 8 730 50 00
Fax No: ++ 46 8 83 52 62
- SWITZERLAND - Farnell InOne**
Tel No: ++ 41 1 204 64 64
Fax No: ++ 41 1 204 64 54
- UK - Farnell InOne**
Tel No: ++ 44 8701 200 200
Fax No: ++ 44 8701 200 201
- UK - BuckHickman InOne**
Tel No: ++ 44 8450 510 150
Fax No: ++ 44 8450 510 130
- UK - CPC**
Tel No: ++ 44 8701 202 530
Fax No: ++ 44 8701 202 531

export EXPORT - Farnell InOne
Tel No: ++ 44 8701 200 208
Fax No: ++ 44 8701 200 209
For enquiries from all other markets

- <http://www.farnellinone.com>
- <http://www.buckhickmaninone.com>
- <http://www.cpc.co.uk>

This data sheet and its contents (the "Information") belong to the Premier Farnell Group (the "Group") or are licensed to it. No licence is granted for the use of it other than for information purposes in connection with the products to which it relates. No licence of any intellectual property rights is granted. The Information is subject to change without notice and replaces all data sheets previously supplied. The Information supplied is believed to be accurate but the Group assumes no responsibility for its accuracy or completeness, any error in or omission from it or for any use made of it. Users of this data sheet should check for themselves the Information and the suitability of the products for their purpose and not make any assumptions based on information included or omitted. Liability for loss or damage resulting from any reliance on the Information or use of it (including liability resulting from negligence or where the Group was aware of the possibility of such loss or damage arising) is excluded. This will not operate to limit or restrict the Group's liability for death or personal injury resulting from its negligence. MULTICOMP is the registered trademark of the Group. © Premier Farnell plc 2004.

**TOLERANCES:
UNLESS OTHERWISE SPECIFIED, DIMENSIONS ARE FOR REFERENCE PURPOSES ONLY.**

| | |
|---------------------|--------------|
| DRAWN BY: | DATE: |
| Veena | 28/01/05 |
| CHECKED BY: | DATE: |
| Shashi | 28/01/05 |
| APPROVED BY: | DATE: |
| | |

| | | | |
|--|--------------------|----------------------------|----------------------|
| DRAWING TITLE: | | | |
| TLL Series - Tact with LED Illumination | | | |
| SIZE | DWG NO. | ELECTRONIC FILE | REV |
| A | M1000000199 | 47885_DWG | |
| SCALE: NTS | | U.O.M.: mm (Inches) | SHEET: 4 OF 4 |