

Small Outline Optoisolators Transistor Output

These devices consist of a gallium arsenide infrared emitting diode optically coupled to a monolithic silicon phototransistor detector, in a surface mountable, small outline, plastic package. They are ideally suited for high density applications, and eliminate the need for through-the-board mounting.

- Convenient Plastic SOIC-8 Surface Mountable Package Style
- Closely Matched Current Transfer Ratios
- Minimum $V_{(BR)CEO}$ of 70 Volts Guaranteed
- Standard SOIC-8 Footprint, with 0.050" Lead Spacing
- Compatible with Dual Wave, Vapor Phase and IR Reflow Soldering
- High Input-Output Isolation of 3000 Vac (rms) Guaranteed
- UL Recognized  File #E90700, Volume 2

Ordering Information:

- To obtain MOC205, 206, 207, 208 in Tape and Reel, add R2 suffix to device numbers:
R2 = 2500 units on 13" reel
- To obtain MOC205, 206, 207, 208 in quantities of 50

in

MOC205
MOC206
MOC207
MOC208

**SMALL OUTLINE
OPTOISOLATORS
TRANSISTOR OUTPUT**

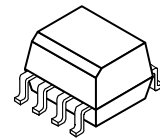

SCHEMATIC

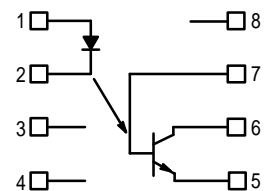

1. LED ANODE
2. LED CATHODE
3. NO CONNECTION
4. NO CONNECTION
5. EMITTER
6. COLLECTOR
7. BASE
8. NO CONNECTION

noted)

Rating	Symbol	Value	Unit
INPUT LED			
Forward Current — Continuous	I_F	60	mA
Forward Current — Peak (PW = 100 μ s, 120 pps)	$I_F(pk)$	1.0	A
Reverse Voltage	V_R	6.0	V
LED Power Dissipation @ $T_A = 25^\circ\text{C}$ Derate above 25°C	P_D	90 0.8	mW mW/ $^\circ\text{C}$
OUTPUT TRANSISTOR			
Collector-Emitter Voltage	V_{CEO}	70	V
Collector-Base Voltage	V_{CBO}	70	V
Emitter-Collector Voltage	V_{ECO}	7.0	V
Collector Current — Continuous	I_C	150	mA
Detector Power Dissipation @ $T_A = 25^\circ\text{C}$ Derate above 25°C	P_D	150 1.76	mW mW/ $^\circ\text{C}$

MAXIMUM RATINGS — continued ($T_A = 25^\circ\text{C}$ unless otherwise noted)

Rating	Symbol	Value	Unit
TOTAL DEVICE			
Input–Output Isolation Voltage ^(1,2) (60 Hz, 1.0 sec. duration)	V_{ISO}	3000	Vac(rms)
Total Device Power Dissipation @ $T_A = 25^\circ\text{C}$ Derate above 25°C	P_D	250 2.94	mW mW/°C
Ambient Operating Temperature Range ⁽³⁾	T_A	–45 to +100	°C
Storage Temperature Range ⁽³⁾	T_{stg}	–45 to +125	°C
Lead Soldering Temperature (1/16" from case, 10 sec. duration)	—	260	°C

ELECTRICAL CHARACTERISTICS ($T_A = 25^\circ\text{C}$ unless otherwise noted)⁽⁴⁾

Characteristic	Symbol	Min	Typ ⁽⁴⁾	Max	Unit
----------------	--------	-----	--------------------	-----	------

INPUT LED

Forward Voltage ($I_F = 10\text{ mA}$)	V_F	—	1.15	1.5	V
Reverse Leakage Current ($V_R = 6.0\text{ V}$)	I_R	—	0.1	100	μA
Capacitance	C	—	18	—	pF

OUTPUT TRANSISTOR

Collector–Emitter Dark Current ($V_{CE} = 10\text{ V}$, $T_A = 25^\circ\text{C}$) ($V_{CE} = 10\text{ V}$, $T_A = 100^\circ\text{C}$)	I_{CEO1}	—	1.0	50	nA
	I_{CEO2}	—	1.0	—	μA
Collector–Emitter Breakdown Voltage ($I_C = 100\ \mu\text{A}$)	$V_{(BR)CEO}$	70	120	—	V
Emitter–Collector Breakdown Voltage ($I_E = 100\ \mu\text{A}$)	$V_{(BR)ECO}$	7.0	7.8	—	V
Collector–Emitter Capacitance ($f = 1.0\text{ MHz}$, $V_{CE} = 0$)	C_{CE}	—	7.0	—	pF

COUPLED

Output Collector Current ($I_F = 10\text{ mA}$, $V_{CE} = 10\text{ V}$)	MOC205 MOC206 MOC207 MOC208	I_C (CTR) ⁽⁵⁾	4.0 (40) 6.3 (63) 10 (100) 4.0 (40)	6.0 (60) 9.4 (94) 15 (150) 8.0 (80)	8.0 (80) 12.5 (125) 20 (200) 12.5 (125)	mA (%)
Collector–Emitter Saturation Voltage ($I_C = 2.0\text{ mA}$, $I_F = 10\text{ mA}$)		$V_{CE(sat)}$	—	0.15	0.4	V
Turn–On Time ($I_C = 2.0\text{ mA}$, $V_{CC} = 10\text{ V}$, $R_L = 100\ \Omega$)		t_{on}	—	3.0	—	μs
Turn–Off Time ($I_C = 2.0\text{ mA}$, $V_{CC} = 10\text{ V}$, $R_L = 100\ \Omega$)		t_{off}	—	2.8	—	μs
Rise Time ($I_C = 2.0\text{ mA}$, $V_{CC} = 10\text{ V}$, $R_L = 100\ \Omega$)		t_r	—	1.6	—	μs
Fall Time ($I_C = 2.0\text{ mA}$, $V_{CC} = 10\text{ V}$, $R_L = 100\ \Omega$)		t_f	—	2.2	—	μs
Input–Output Isolation Voltage ($f = 60\text{ Hz}$, $t = 1.0\text{ sec.}$) ^(1,2)		V_{ISO}	3000	—	—	Vac(rms)
Isolation Resistance ($V_{I-O} = 500\text{ V}$) ⁽²⁾		R_{ISO}	10^{11}	—	—	Ω
Isolation Capacitance ($V_{I-O} = 0$, $f = 1.0\text{ MHz}$) ⁽²⁾		C_{ISO}	—	0.2	—	pF

1. Input–Output Isolation Voltage, V_{ISO} , is an internal device dielectric breakdown rating.
2. For this test, pins 1 and 2 are common, and pins 5, 6 and 7 are common.
3. Refer to Quality and Reliability Section in Opto Data Book for information on test conditions.
4. Always design to the specified minimum/maximum electrical limits (where applicable).
5. Current Transfer Ratio (CTR) = $I_C/I_F \times 100\%$.

TYPICAL CHARACTERISTICS

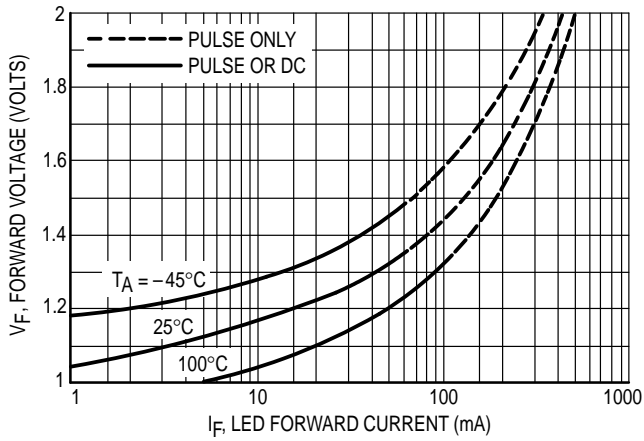

Figure 1. LED Forward Voltage versus Forward Current

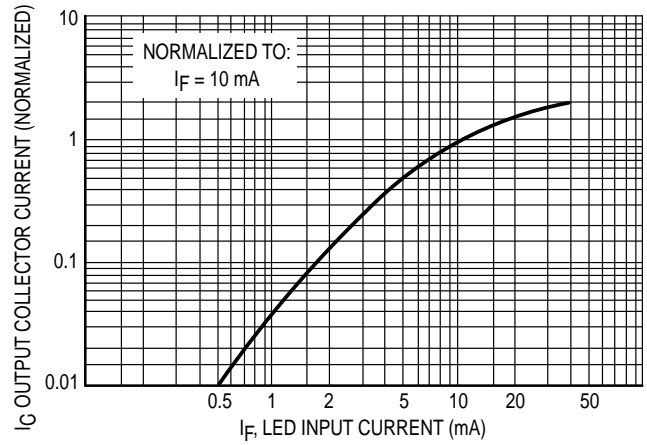

Figure 2. Output Current versus Input Current

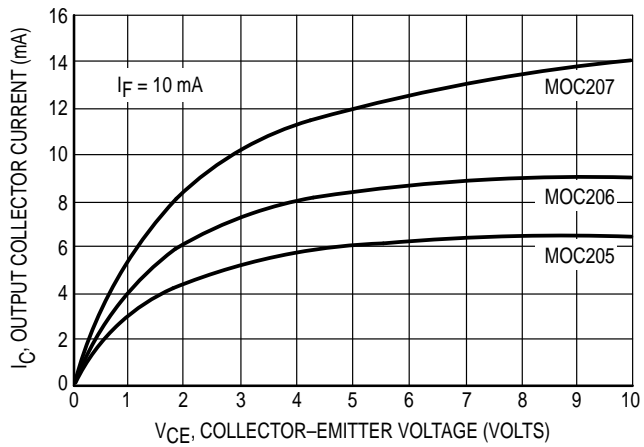

Figure 3. Output Current versus Collector-Emitter Voltage

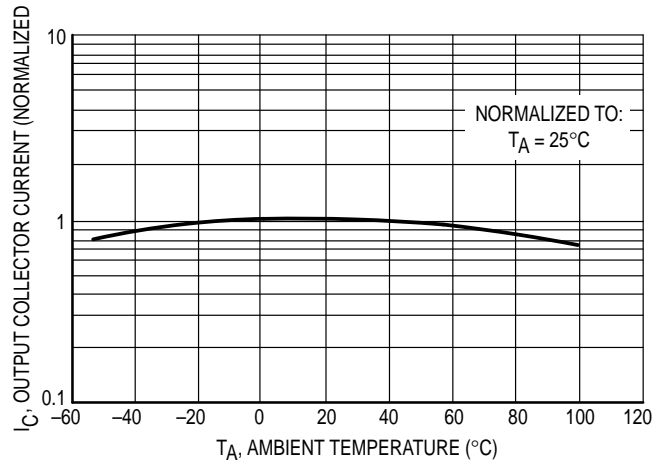

Figure 4. Output Current versus Ambient Temperature

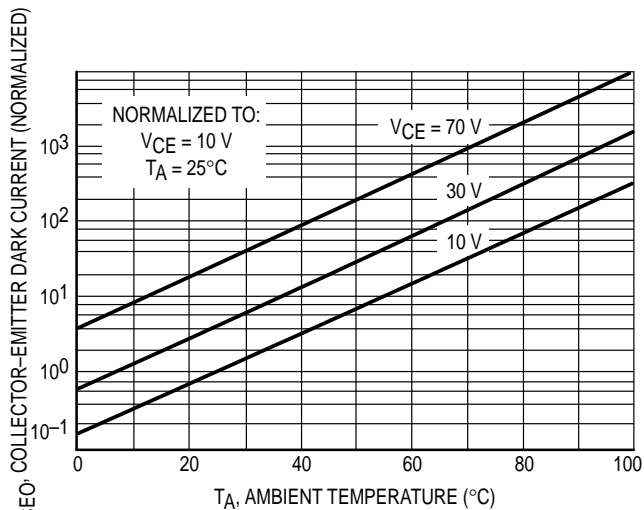

Figure 5. Dark Current versus Ambient Temperature

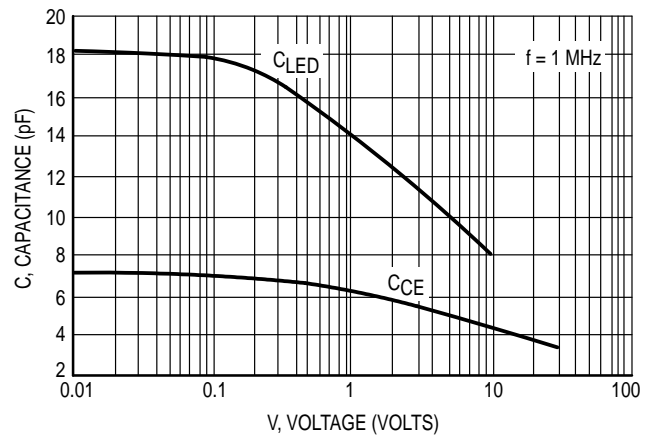
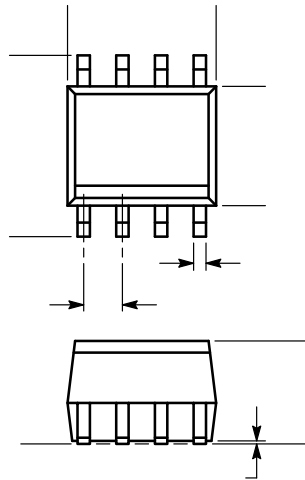

Figure 6. Capacitance versus Voltage



DIM	INCHES		MILLIMETERS	
	MIN	MAX	MIN	MAX
A	0.182	0.202	4.63	5.13
B	0.144	0.164	3.66	4.16

- STYLE 1:
 PIN 1. ANODE
 2. CATHODE
 3. NC
 4. NC
 5. EMITTER
 6. COLLECTOR
 7. BASE
 8. NC

DISCLAIMER

FAIRCHILD SEMICONDUCTOR RESERVES THE RIGHT TO MAKE CHANGES WITHOUT FURTHER NOTICE TO ANY PRODUCTS HEREIN TO IMPROVE RELIABILITY, FUNCTION OR DESIGN. FAIRCHILD DOES NOT ASSUME ANY LIABILITY ARISING OUT OF THE APPLICATION OR USE OF ANY PRODUCT OR CIRCUIT DESCRIBED HEREIN; NEITHER DOES IT CONVEY ANY LICENSE UNDER ITS PATENT RIGHTS, NOR THE RIGHTS OF OTHERS.

LIFE SUPPORT POLICY

FAIRCHILD'S PRODUCTS ARE NOT AUTHORIZED FOR USE AS CRITICAL COMPONENTS IN LIFE SUPPORT DEVICES OR SYSTEMS WITHOUT THE EXPRESS WRITTEN APPROVAL OF THE PRESIDENT OF FAIRCHILD SEMICONDUCTOR CORPORATION. As used herein:

1. Life support devices or systems are devices or systems which, (a) are intended for surgical implant into the body, or (b) support or sustain life, and (c) whose failure to perform when properly used in accordance with instructions for use provided in the labeling, can be reasonably expected to result in a significant injury of the user.
2. A critical component in any component of a life support device or system whose failure to perform can be reasonably expected to cause the failure of the life support device or system, or to affect its safety or effectiveness.