

## UNICASE

[Home Page](#)[E-Mail Us](#)[Catalogue PDF](#)[Get a Catalogue](#)[Get a Drawing](#)[Get a Price](#)[Get a Quote](#)[Customising](#)[IP Ratings](#)[Colour Chart](#)[Ordering Info](#)[Order Form](#)[Distributors](#)[☎ 01489 583858](#)[☎ 01489 583836](#)**FEATURES:**

- Aluminium instrument enclosures
- Robust and versatile design
- Six standard models and four slimline models
- Simple and fast assembly
- Removable internal chassis
- PBC guide rails in the assembly extrusions
- Aluminium front and rear panels included
- Front panels recessed to protect controls
- Four push-in non-slip rubber feet included

**MATERIAL:**

- Aluminium

**PROTECTION CLASS:**

- IP 40 (Not rated)

**FINISH:**

- Powder epoxy polyester paint

**STANDARD COLOURS:**

- Light grey, RAL 7035

**SUPPLY:**

1. Top cover
2. Base cover
3. Assembly profile (x2)
4. Anodised aluminium front panel (x2)
5. Rubber foot (x4)
6. M3 x 8 mm (x16)

**APPLICATIONS:**

- Simple universal enclosures for measuring and control technology, feedback control, peripheral devices and interfaces, switchboxes, modems, medical field and laboratory technology.

[🔍 Assembly Instructions](#)[🖨️ Printable Page](#)

Standard Models



Slimline Models



Internal Chassis

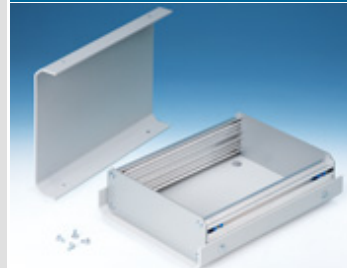

Fast Assembly



Recessed Front Panel

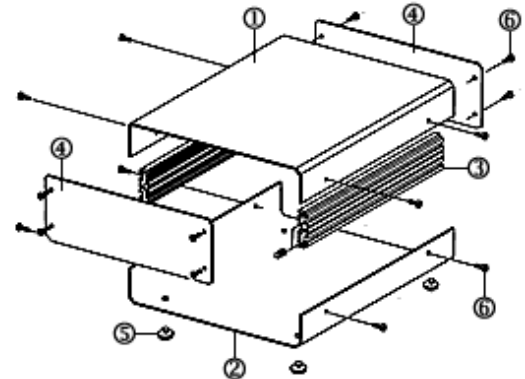

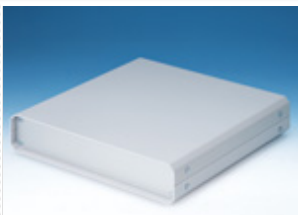

Part No. Slimline Models		Part No. Standard Models	Description	H	W	D	Drawings
<a href="#">M5511110</a>	£		UNICASE SL1	50	130	180	<a href="#">PDF</a>
<a href="#">M5512110</a>	£		UNICASE SL2	50	185	250	<a href="#">PDF</a>
<a href="#">M5513110</a>	£		UNICASE SL3	50	250	250	<a href="#">PDF</a>
<a href="#">M5514110</a>	£		UNICASE SL4	50	250	300	<a href="#">PDF</a>
		<a href="#">M5501110</a>	£ UNICASE 1	65	185	180	<a href="#">PDF</a>
		<a href="#">M5502110</a>	£ UNICASE 2	90	260	250	<a href="#">PDF</a>
		<a href="#">M5503110</a>	£ UNICASE 3	110	350	250	<a href="#">PDF</a>
		<a href="#">M5504110</a>	£ UNICASE 4	134.5	261	300	<a href="#">PDF</a>
		<a href="#">M5505110</a>	£ UNICASE 5	134.5	367	300	<a href="#">PDF</a>
		<a href="#">M5506110</a>	£ UNICASE 6	134.5	474	300	<a href="#">PDF</a>

DWG

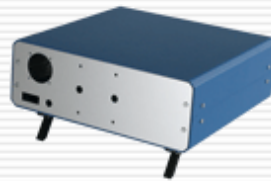

Customising

Tel: 01489 583858 Last Updated: 31-Oct-2007 ©METcase™ UK. All rights reserved.

FIRST ANGLE PROJECTION

Note: Subject to technical modifications without prior notice.  
 Typographical and other errors do not justify any claim for damages.  
 All dimensions should be verified using the actual case.

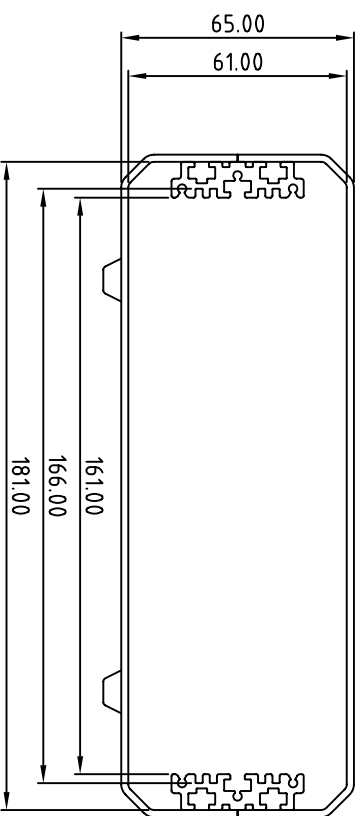
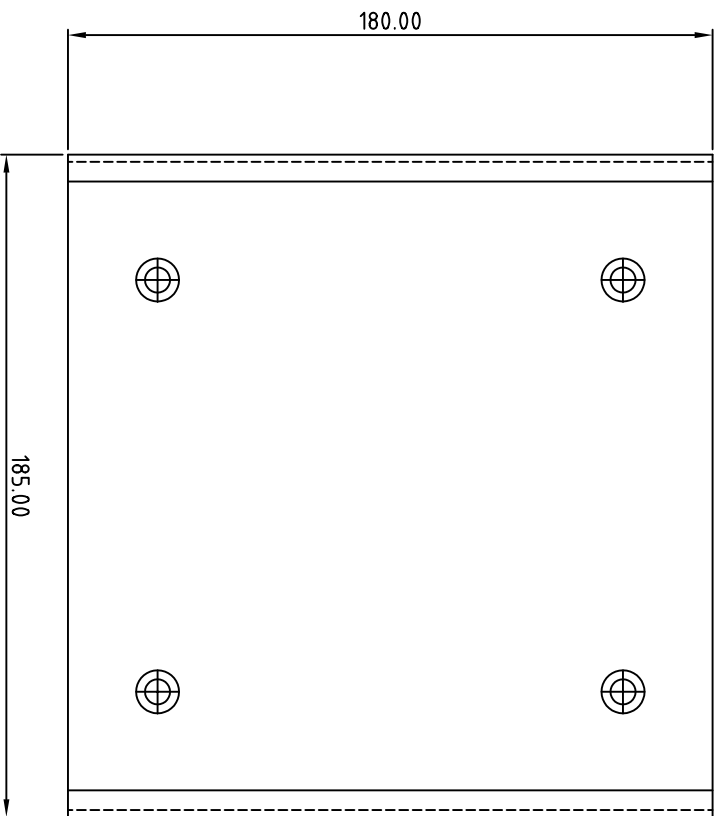
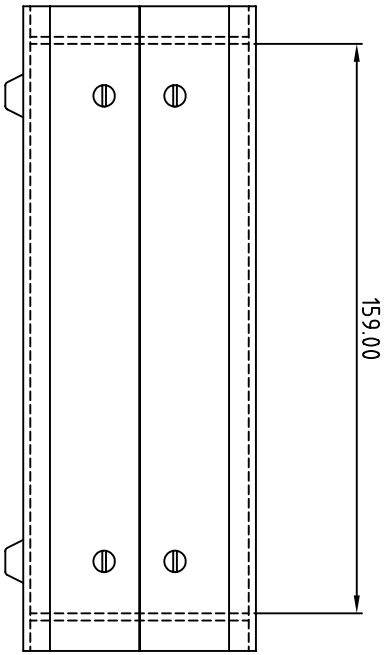
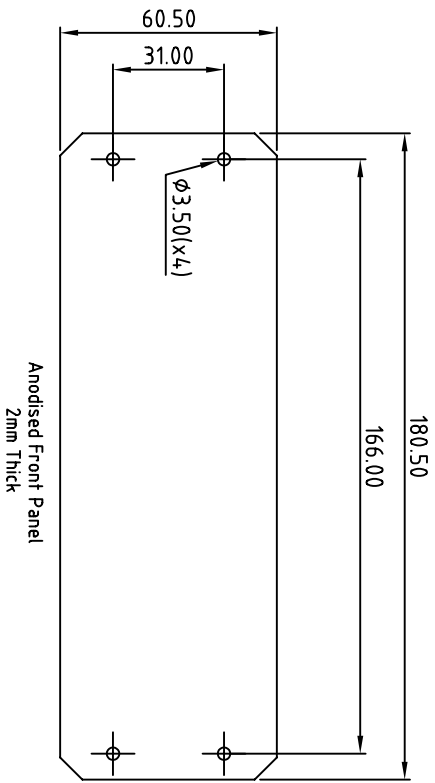

Tolerances unless otherwise stated:

- General tolerances: ±0.20
- Resultant tolerances between hole centers: ±0.15
- Tolerances on hole diameters: ±0.05
- Angles: ± 0.5°
- Surface finish: 32/

Required finish:

Scale: 1:2

Checked by:

Drawing Number:

Date drawn:

August '05

Material Spec:

DO NOT SCALE

**METcase**

METCASE ENCLOSURES  
Unit 3, Mitchell Close

Part Name: UNICASE 1

www.metcase.com

Segensworth East, Fareham,  
Hampshire, PO15 5SE, UK.

Part Number: M5501110

Sheet 1 of 1

OKW ENCLOSURES LTD. DATE AS SHOWN. THIS DRAWING CONTAINS PROPRIETARY INFORMATION OF OKW ENCLOSURES LTD AND IS TENDERED SUBJECT TO THE FOLLOWING CONDITIONS: THE INFORMATION BE RETAINED IN CONFIDENCE, NOT BE REPRODUCED OR COPIED, AND NOT BE USED OR INCORPORATED IN ANY PRODUCT, UNLESS PERMISSION IS OBTAINED IN WRITING FROM OKW ENCLOSURES LTD.

A4