

# 1591XXE Enclosure

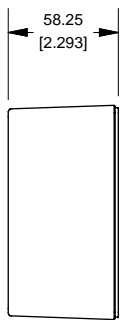

SIDE VIEW OF BOX

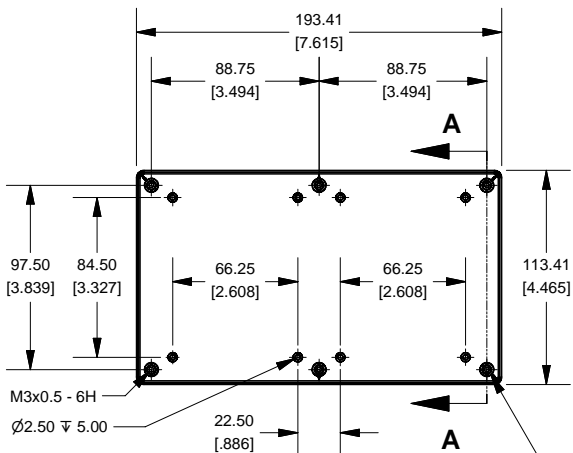

TOP VIEW OF BOX

AVERAGE WALL THICKNESS  
2.00  
[.079]

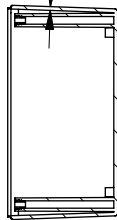

SECTION A-A

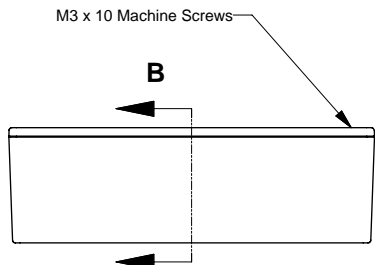
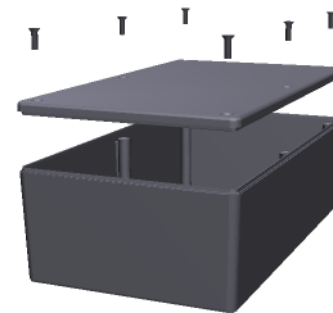

SIDE VIEW OF ENCLOSURE

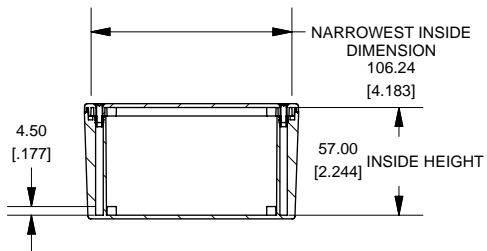

SECTION B-B

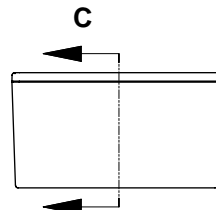

END VIEW OF ENCLOSURE

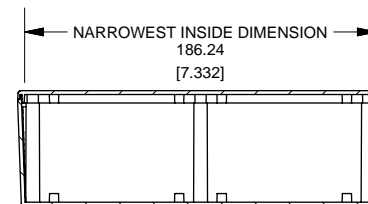

SECTION C-C

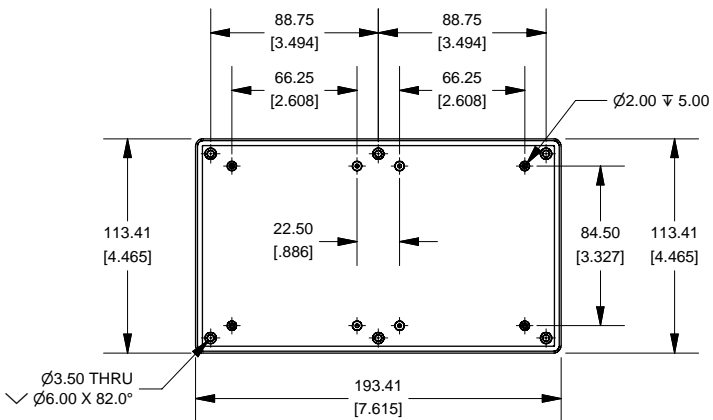

BOTTOM VIEW OF LID

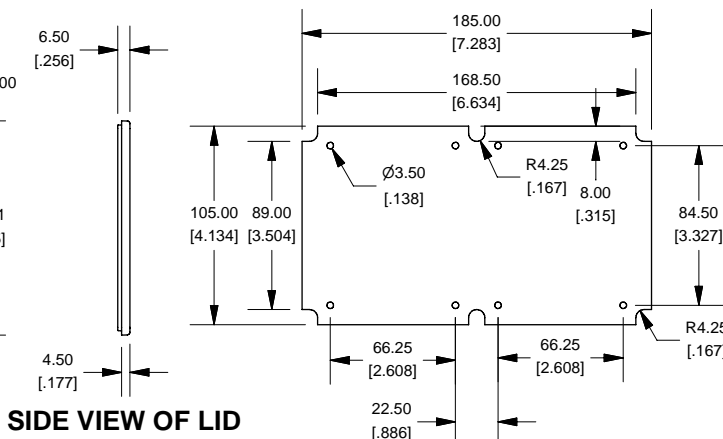

SIDE VIEW OF LID

**Note:**

Enclosures can be Factory Modified ( Milling, Drilling, Printing etc. )  
Solid models of this enclosure available in STEP or IGES.  
Contact Factory [mjm@hammondmfg.com](mailto:mjm@hammondmfg.com)

NOTE		
Enclosure molded from FRABS UL 94-V0 Plastic. Other materials / Colours Available Consult Factory		
1591XXE		
1590XXE Enclosure		
Black Enclosure - RAL 7011	1591XXEBK	
Gray Enclosure - RAL 7035	1591XXEGY	
ACCESSORIES		
For Flame Retardant ABS (UL94-V0)		
Black Enclosure Cover Screws (Pkg 100)	1591MS100BK	
Gray Enclosure Cover Screws (Pkg 100)	1591MS100	
P.C. Board Screws (All Boxes)		
P.C. Board Screws	1593ATS50 (Pkg 50)	1593ATS100 (Pkg 100)
#4 x 1/4" self-tapping (6.4mm)		



Max Size PCB. Fits in Box or in Lid.  
Not supplied with Enclosure