

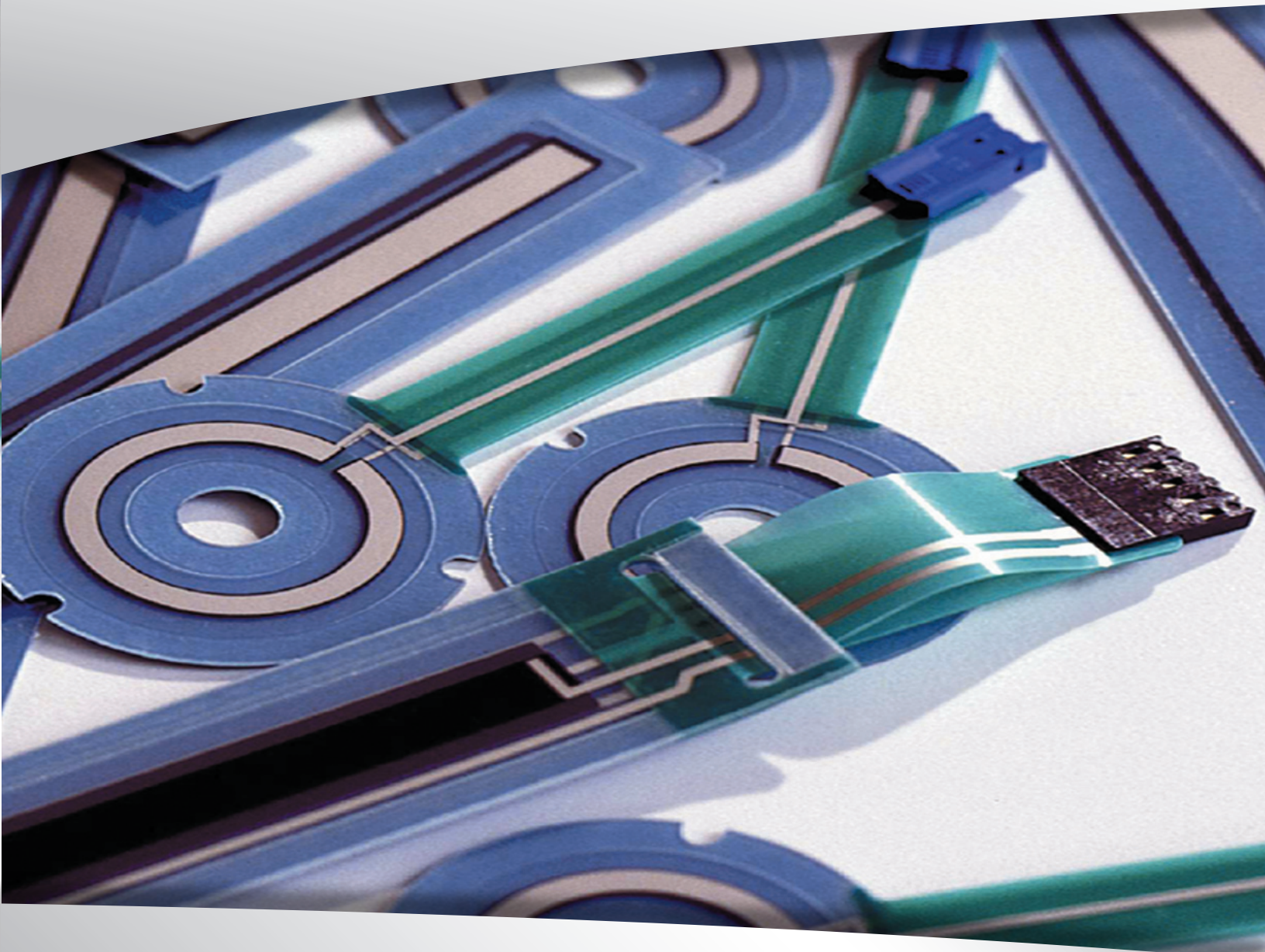

# MAVRITE GLOBAL INC.

ENGINEERING CONCEPTS AND SOLUTIONS

[WWW.MAVRITEGLOBAL.COM](http://WWW.MAVRITEGLOBAL.COM)



## Membrane Potentiometers

# MEMBRANE POTENTIOMETER

## Product Guide

### FEATURES

- Thickness: 0.7mm (Standard), 1.7mm (Magnetic), and 0.7mm (Hybrid)
- Linear and rotary (incl. multi-turn) designs are possible
- Excellent accuracy and linearity
- Life cycle: between 1 and 20 million operations
- Temperature ranges: up to +125° C (257°F)
- NEMA 4 sealed (IP 42) – Up to IP 67 / NEMA 4X possible upon request
- Non-contact (magnetic) version with excellent product features available
- All products can be fully customized with a short lead time

### COMPOSITION (from bottom to top)

- Adhesive film, selection according to requirement
- Basic membrane with potentiometer resistance
- Spacers between upper and lower membrane
- Collector membrane as wiper tap for hand or wiper actuation

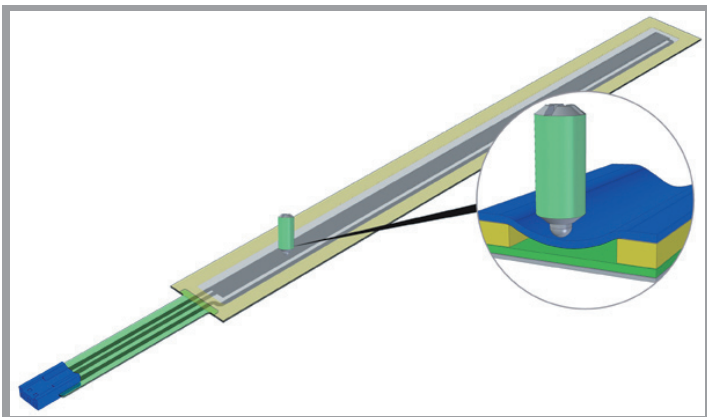
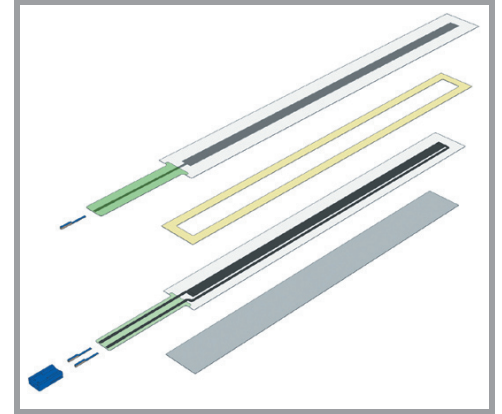

### HOW DOES IT WORK?

Membrane potentiometers are used as voltage dividers and consist of several layers, which are separated by a so-called 'spacer'. These layers are connected to each other through mechanical or magnetical pressure and create a contact. The contact can be made either by hand or by using a mechanical wiper (see picture). It is also possible to have a non-contact operation by using a magnet instead of a wiper.

### CUSTOMIZED DESIGN

There are virtually no limitations when it comes to the customization of membrane potentiometers. No matter if linear, rotary or custom shaped with membrane technology almost any customer requirement can be fulfilled.

### GENERAL PRODUCT INFORMATION

Due to their design of 0.7 mm to 2.2 mm and their simple adaptation to customer requirements, membrane potentiometers from Mavrite Global are the perfect solution for restricted installation conditions. The technical specifications of the membrane potentiometers correspond to those of conventional precision potentiometers or even surpass these. They offer an attractive cost advantage and are easy to use.

Standard elements of 50 mm to 500 mm are available, as well as very favorably priced customer-specific variations. In particular, the good repeat accuracy, the easy to achieve redundancy and the problem-free integration represent decisive advantages. The potentiometer follows the shape and function of the specific application: linear, circular or customer-specific shapes are available, on request also with non-contact connection.

Depending on various parameters, the service life comprises 1 million cycles to 20 million cycles and the repeat accuracy 1 mm to 0.5mm. The standard products are sealed to IP 42 with an optional sealing to IP67 / NEMA 4X.





TECHNICAL SPECIFICATIONS

# Technical Specifications

Electrical Data	Foil-based			FR4-based			Options
	Standard	Magnet	Hybrid <sup>(1)</sup>	Standard	Magnet	Hybrid <sup>(1)</sup>	
Resistance / 100mm (Standard)	2.5 kΩ	2.5 kΩ	2.5 kΩ	10 kΩ	10 kΩ	10 kΩ	up to 150 kΩ per 100mm
Resistance Tolerance	± 30%	± 30%	± 30%	± 30%	± 30%	± 30%	± 10%
Linearity (Independent) <sup>(2)</sup>	2% linear		n.a.	2% linear		n.a.	1% (Foil) 0.5% (FR4)
Repeat Accuracy	0.5 mm	1.0 mm	0.75 mm	0.5 mm	1.0 mm	0.75 mm	
Voltage (Standard)	5V to 30 V	5V to 30 V	5V to 30 V	5V to 30 V	5V to 30 V	5V to 30 V	1V to 64V
Mechanical Data	Standard	Magnet	Hybrid	Standard	Magnet	Hybrid	Options
Life Cycle (Operations) <sup>(3)</sup>	> 1 Million	> 20 Million	> 3 Million	>1 Million	> 20 Million	> 3 Million	
Wiper Force <sup>(4)</sup>	1-3 N		2-6 N	1-3 N		2-6 N	
Recommended Wiper	WS1-3N		WH2-6N	WS1-3N		WH2-6N	
Recommended Magnet		MD44-N52			MD44-N52		
Distance to Magnet in mm		≤ 1.5 mm			≤ 1.5 mm		
Height without connector <sup>(5)</sup>	0.7 mm	1.7 mm	0.7 mm	1.2 mm	2.2 mm	1.2 mm	
Connector (Standard)	Berg 3-pole	Berg 3-pole	Berg 3-pole	Solder Tabs	Solder Tabs	Solder Tabs	Solder Tabs / ZIF
Product Dimensions	Standard	Magnet	Hybrid	Standard	Magnet	Hybrid	Options
Linear							
Stand. length (min./max.) <sup>(5,6)</sup>	50 - 500 mm	50 - 500 mm	50 - 500 mm	50 - 500 mm	50 - 500 mm	50 - 500 mm	9 - 1000 mm
Width (min. / Standard) <sup>(5)</sup>	13 mm / 22 mm	13 mm / 22 mm	16 mm / 22 mm	13 mm / 22 mm	13 mm / 22 mm	16 mm / 22 mm	min. 9 mm
Rotary							
Inside diameter (min./max.) <sup>(5,6)</sup>	0 - 450 mm	0 - 450 mm	0 - 450 mm	0 - 450 mm	0 - 450 mm	0 - 450 mm	Standard 8 mm
Outside diameter (min./max.) <sup>(5)</sup>	22 - 500 mm	22 - 500 mm	22 - 500 mm	22 - 500 mm	22 - 500 mm	22 - 500 mm	Standard 40 mm
Other Specifications	Standard	Magnet	Hybrid	Standard	Magnet	Hybrid	Options
Temperature Range	-40°C / +55°C	-25°C / +55°C	-40°C / +125°C	-40°C / +55°C	-25°C / +55°C	-40°C / +125°C	
	-40°F / +131°F	-13°F / +131°F	-40°F / +257°F	-40°F / +131°F	-13°F / +131°F	-40°F / +257°F	
IP Rating (full product)	IP 54	IP 42	IP 42	IP 42	IP 42	IP 42	up to IP 67

Notes:

- (1) Values based on current product development.
- (2) Values can vary depending on customer design.
- (3) Values have been determined with Mavrite Global specifications. Life Cycle can vary depending on customer wiper design.
- (4) Recommended magnet MD44-N52 with 2mm distance will create 1N wiper pressure (with standard products).
- (5) Dimensions based on DIN ISO 2768.
- (6) Active electrical path.



OFF-THE-SHELF SOLUTIONS FOR EASY INTEGRATION

## STOCK PRODUCTS Linear Membrane Potentiometers

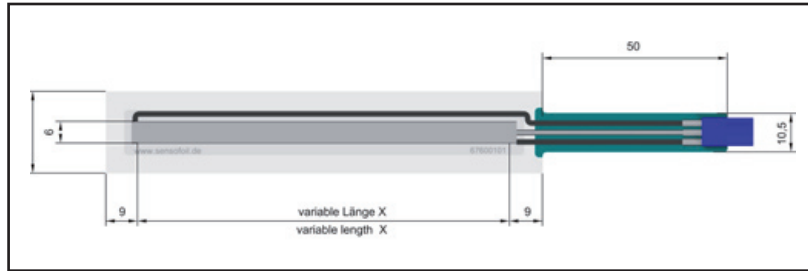

### Standard Linear Foil/Foil

Part #	Active Length	Active Width	Height
SL67600162	50mm	22mm	.7mm
SL67600163	100mm	22mm	.7mm
SL67600164	200mm	22mm	.7mm
SL67600171	300mm	22mm	.7mm
SL67600172	400mm	22mm	.7mm
SL67600173	500mm	22mm	.7mm

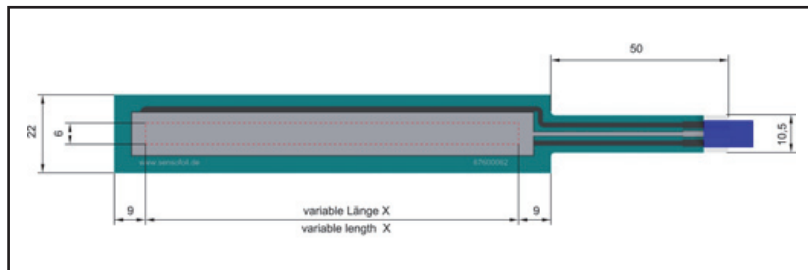

### Hybrid Linear Foil/Foil

Part #	Active Length	Active Width	Height
HL67600165	100mm	22mm	.7mm

Standard connector: BERG 3-pole jack connector

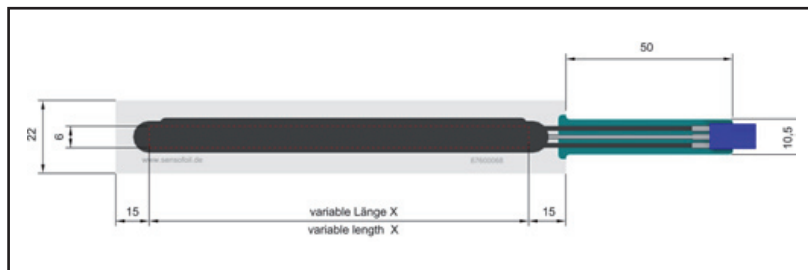

### Magnetic Linear Foil/Foil

Part #	Active Length	Active Width	Height
ML67600166	100mm	22mm	1.7mm
ML67600176	300mm	22mm	1.7mm

Standard connector: BERG 3-pole jack connector



OFF-THE-SHELF SOLUTIONS FOR EASY INTEGRATION

## STOCK PRODUCTS Linear Membrane Potentiometers

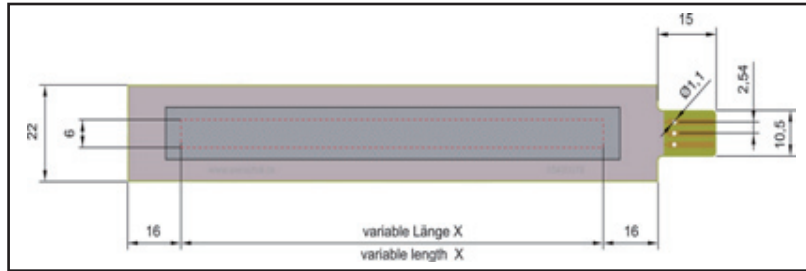

### Hybrid Linear FR4

Part #	Active Length	Active Width	Height
FHL65400176	100mm	22mm	1.2mm

Standard connector: Solder tabs

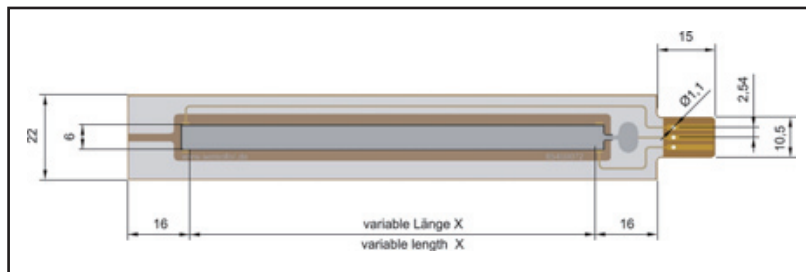

### Standard Linear FR4

Part #	Active Length	Active Width	Height
FSL6540127	100mm	22mm	1.2mm

Standard connector: Solder tabs

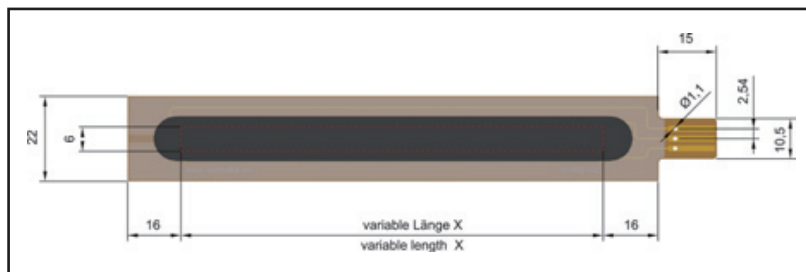

### Magnetic Linear FR4

Part #	Active Length	Active Width	Height
FML65400177	100mm	22mm	2.2mm

Standard connector: Solder tabs



OFF-THE-SHELF SOLUTIONS FOR EASY INTEGRATION

## STOCK PRODUCTS Rotary Membrane Potentiometers

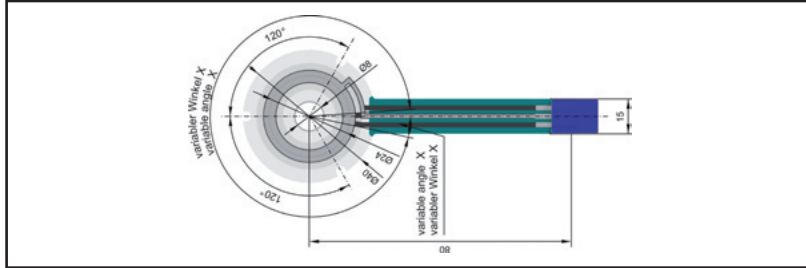

### Standard Rotary Foil/Foil

Part #	Diameter (in)	Diameter (out)	Angle
SR67600168	8mm	40mm	345°
SR67600169	8mm	40mm	360°
SR67600178	8mm	40mm	90°
SR67600167	8mm	40mm	180°
SR67600177	8mm	40mm	270°

Standard connector: BERG 3-pole jack connector

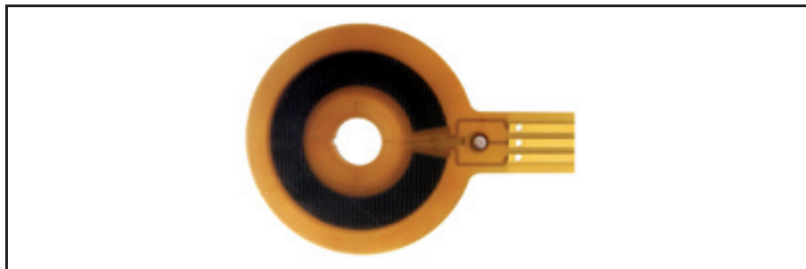

### Standard Rotary FR4

Part #	Diameter (in)	Diameter (out)	Angle
FR65400178	8mm	40mm	340°

Standard connector: Solder tabs



OFF-THE-SHELF SOLUTIONS FOR EASY INTEGRATION

## STOCK PRODUCTS

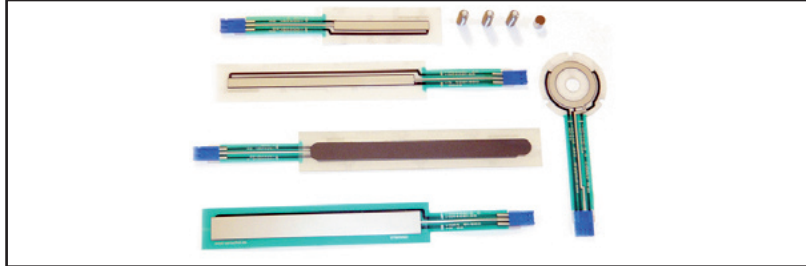

### Developer Kit

Part #	Total Parts	Products
KIT-0001	8mm	Standard, Hybrid & Magnetic
1 x MAGNET D44-N52 for MAGNET 1 x WIPER 2-6N for HYBRID 2 x WIPER 1-3N for STANDARD 1 x MAGNET Linear Membrane Potentiometer 100 mm 1 x HYBRID Linear Membrane Potentiometer 100 mm 1 x STANDARD Rotary Membrane Potentiometer 360 1 x STANDARD Linear Membrane Potentiometer 100 mm 1 x STANDARD Linear Membrane Potentiometer 50 mm		

### ACCESSORIES

### wipers & magnets



Magnet MD44-N52

Wiper 1-3N & 2-6N

Standard Rotary Foil/Foil			
Part #	Product	Use	Length
WS1-3N	Wiper 1-3N	Standard	14mm
WH2-6N	Wiper 2-6N	Hybrid	14mm
MD44-N52	Magnet D44-N52	Magnetic	6.35mm



Membrane potentiometers by Mavrite Global can be designed and manufactured based on your individual requirements. To do so, we will need your specifications. Please send this page by fax to Mavrite Global @ 866-709-2441

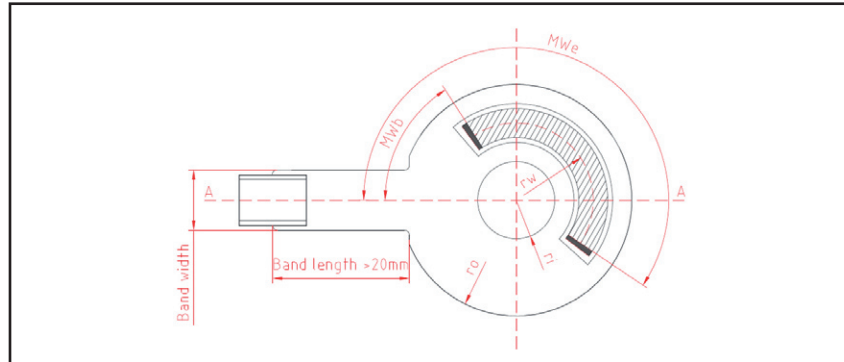

Rotary Potentiometer		
Radius Outside (ra)	mm	min 22mm
Radius Inside (ri)	mm	none if no hole needed
Wiper Radius (rw)	mm	min/max
Active Angle Start	o	0° - 360°
Active Angle End	o	0° - 360°

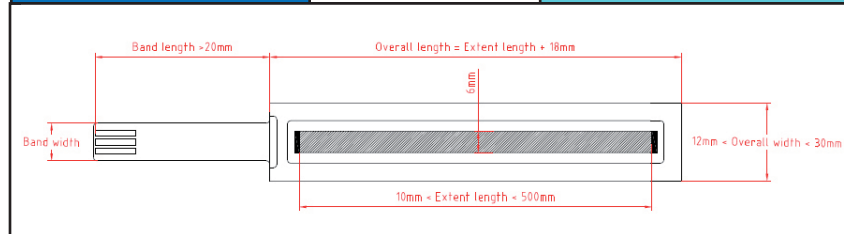

Linear Potentiometer		
Active Length	mm	9mm - 1,000mm
Overall Length	mm	27mm - 1,018 mm
Overall Width	mm	min .9mm
Resistance		kΩ
Independant Linearity	±	%
Repeat Accuracy		mm
Connector		Standard Connectors See Spec Sheet
Wiper Design		Standard Wiper or Specify Custom
Wiper Pressure	min N      max N	
Life Cycle	million operations	
Operating Temperature	min                  max	□ ° F or □ ° C

Company Name	
Contact Name	
Email address	
Phone	
Fax	
Company Address	





# MAVRITE GLOBAL INC.

ENGINEERING CONCEPTS AND SOLUTIONS

[WWW.MAVRITEGLOBAL.COM](http://WWW.MAVRITEGLOBAL.COM)

Mavrite Global represents manufacturers of an extensive range of products such as Linear and Rotary Potentiometers, Joysticks, and Electronic Valve Actuators. All manufactured from the best quality components.

These products can be used for position measurements, control applications and fluid control as well as many phases of Industrial Automation Process.

Our commitment is to supply a superior product and Engineering solutions that will solve our customer's problems and product requirements.

All our products are RoHS compliant.

Phone: 866-709-2440 or 760-930-9814

Fax: 866-709-2441 or 760-930-9625

Mavrite Global  
2382 Faraday Ave 310-K  
Carlsbad, CA 92008