

herga



Pressure & Vacuum Switches

SWITCHING AND SENSING SOLUTIONS



Herga Electric Limited is an independent UK manufacturer of switching systems. In addition to pressure and vacuum switches, we offer other innovative switching solutions:-

hergair	Airswitching systems
herga	Footswitches
hergalite	Fibre Optics / Infra red safety products
herga	Hand controls

Our expertise spans the automotive, medical, packaging, domestic appliance and spa industries.

Herga is driven to respond rapidly to delight our customers. Herga seeks to develop its relations with customers to achieve their business goals.

Global Presence

Our distributor network covering the worlds major markets enables technical help and assistance to be just a phone call away.

Continuous Improvement

Herga's approval to ISO 9002 ensures that we are fully in control of our quality. However, this is just the starting point for an aspiring World Class company. We encourage training and development and continuous improvements at individual, team and company level.

How can we help you?

This brochure provides a brief overview of our product range. If you require further information, please contact us at our e-mail address:
herga.electric@dial.pipex.com

Herga's customers worldwide include

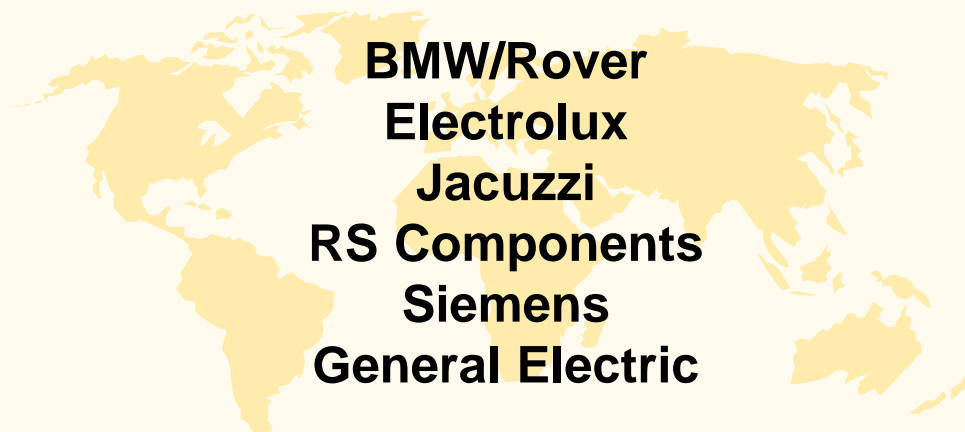

<p>6702 High Pressure Switch High pressure switch all plastic construction. Ranges 1.4-13.8 Bar (20-200 PSI). Two (2) Pole Electrical Switching.</p>		<p>Page PV1 & 2</p>
<p>6773 Double Diaphragm Pressure Switch Double diaphragm construction to meet double insulation requirements of EN 60335-2-60. Water presence detection.</p>		<p>Page PV3</p>
<p>6761 and 6763 Low Air Pressure Vacuum Switches Printed circuit board mounted, pressure/vacuum switches. UL versions available. Range from (0.015 Bar - 1.0 Bar Pressure) (-0.015 Bar - 0.670 Bar Vacuum).</p>		<p>Page PV4</p>
<p>6741 and 6742 Medium Pressure Switches Constructed in Nylon 12 material (pressure range 0.1 Bar to 8.2 Bar). Single or double pole in 8 adjustable switch ranges. UL versions available.</p>		<p>Page PV5 & 6</p>
<p>6731 and 6732 Low Pressure Switches Constructed in Nylon 12 material (pressure range 0.0037 Bar to 0.137 Bar). Single or double pole in 3 adjustable switch ranges. UL versions available.</p>		<p>Page PV7 & 8</p>
<p>6753 Low Air Pressure/Vacuum Switches Small versatile compact differential switch with low contact inertia for rapid switching (range 2.5 mbar to 40 mbar).</p>		<p>Page PV9 & 10</p>
<p>6721 and 6722 Vacuum Switches Constructed in Nylon 12 material (vacuum range -0.0075 Bar to -0.670 Bar). Single or double pole in 5 adjustable switch ranges. UL versions available.</p>		<p>Page PV11 & 12</p>
<p>Pressure Conversion Chart For more commonly used measurements, including flow, liquid, force and weight equivalents.</p>		<p>Page PV13</p>
<p>Certification Markings Covers most worldwide authorities/certification marks.</p>		<p>Page PV14</p>
<p>Accessories / Switch Housings Air and electrical connections are available for all pressure and vacuum switches. Please also refer to Airswitching section or contact herga for details.</p>		<p>Page PV15</p>
<p>Fax Back Sheet For your fast quotation service.</p>		<p>Page PV16</p>

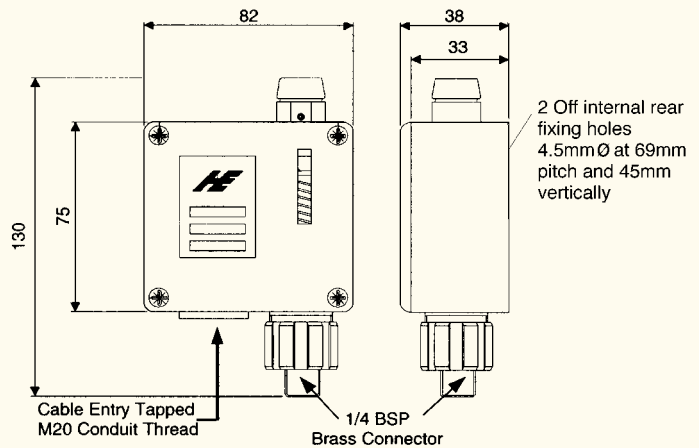

Benefits

- ❖ High pressure switch, all plastic construction (glass loaded nylon)
- ❖ Alternate diaphragm and connectors available for volume orders

- ❖ Excellent repeatability
- ❖ Switches have adjustable pressure and differential
- ❖ Specific settings can be set for volume orders
- ❖ IP65 enclosures class II double insulated

6702 - - 0 0 0 0

1. Model Number

2. Operating Pressure

- A 20 - 50 PSI (1.40 - 3.45 Bar) Red Spring
- B 40 - 100 PSI (2.76 - 6.89 Bar) White Spring
- C 80 - 200 PSI (5.52 - 13.79 Bar) Blue Spring

3. Additional Operating (Springs)

- A 20 - 50 PSI (1.40 - 3.45 Bar)
- B 40 - 100 PSI (2.76 - 6.89 Bar)
- C 80 - 200 PSI (5.52 - 13.79 Bar)
- D 20 - 50 PSI (1.40 - 3.45 Bar) & 40 - 100 PSI (2.76 - 6.89 Bar)
- E 40 - 100 PSI (2.76 - 6.89 Bar) & 80 - 200 PSI (5.52 - 13.79 Bar)
- F 80 - 200 PSI (5.52 - 13.79 Bar) & 20 - 50 PSI (1.40 - 3.45 Bar)
- G 20 - 50 PSI (1.40 - 3.45 Bar) & 40 - 100 PSI (2.76 - 6.89 Bar) & 80 - 200 PSI (5.52 - 13.79 Bar)
- Z No additional springs supplied

4. Electrical Microswitching Rating

- A 21A 250V ac Silver Change Over Contacts
- B 0.1A 250V ac Gold Change Over Contacts
- C 0.1A 24V ac/dc Gold Change Over Contacts

5. Packaging and Label Option

- A Herga individually packed in plain carton
- B Herga vacuum form tray (for quantities 10+)

6702 ~ High Pressure Switch



6702 Pressure Switch

The industrial pressure switch is moulded entirely in plastic with the exception of the pressure connection and is water, oil and dust proof to IP65. The switches have excellent repeat accuracy, even over widely varying ambient conditions.

The operating pressure is adjustable externally using the thumb screw on the top and the approximate pressure setting can be seen through a window in the cover. To discourage unauthorised tampering, the adjusting screw can be locked in position with an M1.5mm Allen screw.

The microswitches have independent vernier adjustment and are normally set to operate within 2 PSI on rising pressure. Where two pressure levels are to be controlled, the switches can be adjusted separately so that one switch will operate at up to 80% of the level of the second. The switches can also be set to operate simultaneously on falling pressure instead of rising pressure.

The pressure switch is of Class II construction with double insulation. For quantity orders, many special options are available, please enquire:-

- ❖ Single or double pole switching set to specific pressure levels
- ❖ Alternative connector sizes
- ❖ Alternative diaphragms and metal chambers to resist particular fluids
- ❖ Installation and setting instructions are supplied with each product

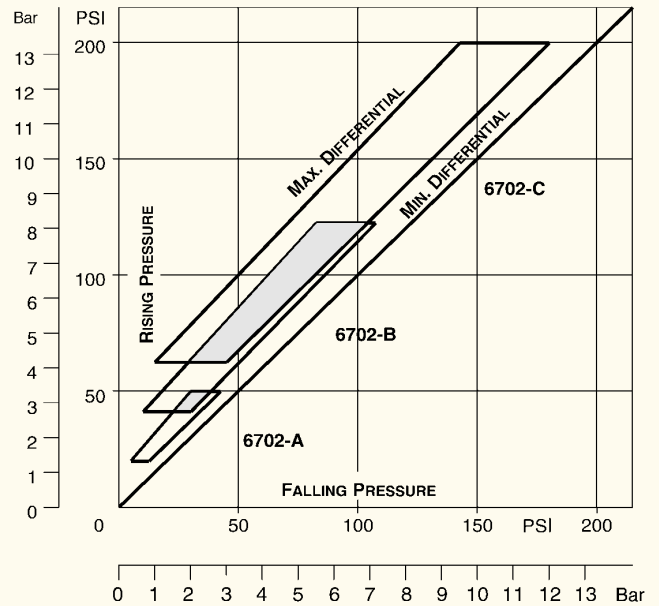

Note: differentials are approximate

Other Information

Withstand pressure	500 PSI (34.5 Bar)
Setting accuracy when set by herga	± 10%
Temperature range	-5°C to +70°C
Diaphragm	Fabric reinforced Nitrile
Weight	300g

Silver Contact Microswitch Data

Average Life Expectancy	Mechanical	1.0 x 10 ⁶		
	Electrical	2.0 x 10 ⁵ @ 10A 1.0 x 10 ⁴ @ 21A		
Electrical Rating		Max. Electrical Load		
	Voltage	Res.	Ind.	(Pf 0.75 Motor)
AC	250V	21A		1HP
	250V	21A	8A	2HP
	125V	21A		
DC	6V	21A	21A	
	12V	15A	15A	
	24V	8A	7A	
	60V	1A	0.5A	
	110V	0.5A	0.2A	
	220V	0.25A	0.1A	

Gold Contact Microswitch Data

Average Life Expectancy	Mechanical	1.0 x 1.0 ⁶		
	Electrical	2.0 x 10 ⁵ @ 10A 1.0 x 10 ⁴ @ 21A		
Electrical Rating		Max. Electrical Load		
	Voltage	Res.	Ind.	(Pf 0.75 Motor)
AC	250V	0.1A	0.05	N/A
UL/CSA Only	125V	0.1A	-----	-----

Switch Standards: EN 60730, EN 61058 and UL 508

Approvals Available: CE, BEAB, CSA, DEMCO, IMQ, KEMA, NEMCO, OVE, SEMCO, SET I, SEV, UL, VDE

Suitability for use with different operating media

Pressure Medium	6702
Acetone	<input checked="" type="checkbox"/>
Ammonia (Liquid)	<input checked="" type="checkbox"/>
Amyl Alcohol to 20°C	<input checked="" type="checkbox"/>
Automotive Brake Fluid	<input checked="" type="checkbox"/>
Beer	<input checked="" type="checkbox"/>
Butane	<input checked="" type="checkbox"/>
Carbon Dioxide (Dry)	<input checked="" type="checkbox"/>
Citric Acid	<input checked="" type="checkbox"/>
Copper Sulphate (Sol.)	<input checked="" type="checkbox"/>
Compressed Air	<input checked="" type="checkbox"/>
Cutting Oil	<input checked="" type="checkbox"/>
Diesel Oil	<input checked="" type="checkbox"/>
Detergent Solution	<input checked="" type="checkbox"/>
Fuel Oil	<input checked="" type="checkbox"/>
Glycol	<input checked="" type="checkbox"/>
Hydraulic Oil	<input checked="" type="checkbox"/>
Hydrogen	<input checked="" type="checkbox"/>
Lubricating Oil	<input checked="" type="checkbox"/>
Milk	<input checked="" type="checkbox"/>
Mineral Oil	<input checked="" type="checkbox"/>
Natural Gas	<input checked="" type="checkbox"/>
Oxygen to 70°C	<input checked="" type="checkbox"/>
Petrol	<input checked="" type="checkbox"/>
Plating Solution (Chrome)	<input checked="" type="checkbox"/>
Salt Water	<input checked="" type="checkbox"/>
Sewage	<input checked="" type="checkbox"/>
Turpentine	<input checked="" type="checkbox"/>
Vinegar	<input checked="" type="checkbox"/>
Water	<input checked="" type="checkbox"/>

✓ = Recommended = Suitable with modifications

Note: Dry Switching - if switching low power circuits, low current (4 to 100 milliampères) and low voltage (below 30V), consult herga or refer to gold contact in section 4 of the opposite page.

Herga do not accept liability for any pressure operated device used outside the pressure range specified by the company.

6773 ~ Double Diaphragm Pressure Switch

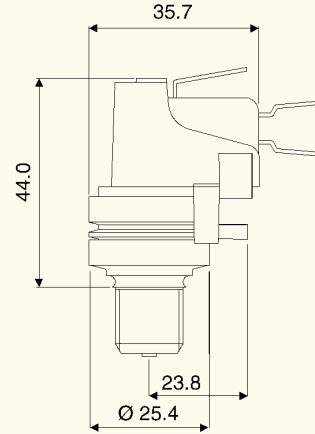
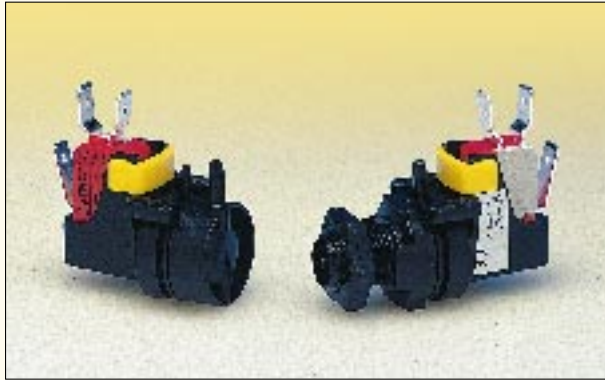

- Benefits**
- ❖ Specified to EN 60335-2-60 double insulated for water detection
 - ❖ Various microswitch options

- ❖ Gold contacts available
- ❖ Other pressures available up to 10 PSI
- ❖ Multiple cap and spout options available

6773 - A [] [] [] - A [] [] []

1. Model Number

2. Pressure Range

A 250mm H₂O to 760mm H₂O Standard

3. Caps

- A Side Entry Std Spout Std Orientation 4.0mm Spout
- B Side Entry Std Spout Rotated 90° Viewed From Cap 4.0mmØ Spout
- C Side Entry Std Spout Rotated 180° Viewed From Cap 4.0mmØ Spout
- D Side Entry Std Spout Rotated 270° Viewed From Cap 4.0mmØ Spout
- E Side Entry Long Spout 4.0mmØ Std Orientation
- F Side Entry Long Spout Rotated 90° Viewed From Cap 4.0mmØ Spout
- G Side Entry Long Spout Rotated 180° Viewed From Cap 4.0mmØ Spout
- H Back Entry Short Thread 4.0mmØ Spout. Not suitable for 'O' ring
- J Back Entry Long Thread 4.0mmØ Spout
- K Back Entry Long Thread 2.0mmØ Spout
- L Long Thread Spout Rotated @ 90° 4.0mmØ Spout

4. Bleed

- A No Bleed Cap
- J With Bleed Cap

5. Nut Specification

- A Black Moulded Nut
- B Black Moulded Nut and 'O' Ring (only available with options 3J, K & L above)

6. Authority

A European Tag Configuration

7. Terminal Combinations

- A 3 Blade QC 6.3mm x 0.8mm
- B 2 Blade QC 6.3mm x 0.8mm Normally Open Contacts
- C 2 Blade QC 6.3mm x 0.9mm 90° Crank Normally Open Contacts

8. Microswitch Rating

- A 0.1A 125/250V ac Gold Contacts (not available with option 7c)
- B 10A 1/4 HP 125/250V ac
- C 21A 250V ac 1 HP 125V ac 2 HP 250V ac

6761 & 6763 ~ Low Air Pressure Vacuum Switches (slow make contacts)

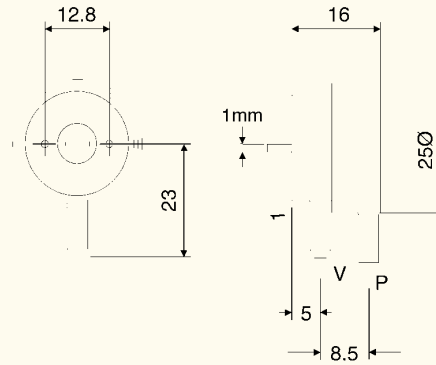
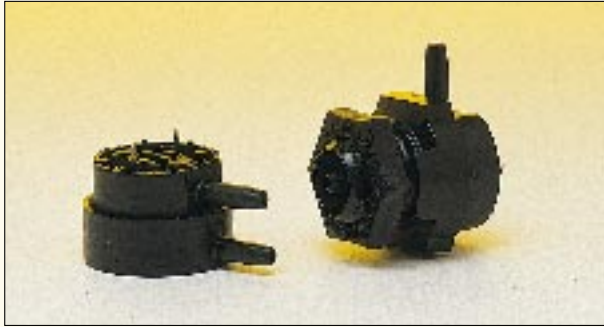

Benefits

- ❖ A range of small switches designed for direct mounting onto printed circuit boards
- ❖ UL versions available
- ❖ Various spout orientations available
- ❖ Double diaphragm versions available upon request

- ❖ Available with base or side tube entry
- ❖ Silver or gold contact options
- ❖ Switches can be factory set within specified tolerances
- ❖ 'O' ring seals available for dust and water tight applications, back entry versions only

Printed Circuit Board Mounting Switches		6761 (Vacuum)	6763 (Pressure)
Model No		6761 (Vacuum)	6763 (Pressure)
Pressure/Vacuum range	Minimum	150mm (6 ins) Wg	150mm (6 ins) Wg
	Maximum	670 millibar (9.8) PSI	1.0 Bar (14.7) PSI
Maximum Differential		Approximately 0.06 ins WG	Approximately 0.06 ins WG
Pressure/Vacuum Range		Adjustable variants	Adjustable variants
Body Withstand Pressure		2.7 Bar (40) PSI	2.7 Bar (40) PSI
Air Bleed Version		Available upon request	Available upon request
Flow Rate Litre / Min (with air bleed)		8 - 30cc/Min @ 31 ins WG	8 - 30cc/Min @ 31 ins WG
Pressure Connection		4mm Ø spout for side and back entry 2mm Ø spout for back entry only Lower spout 'V' vacuum	4mm Ø spout for side and back entry 2mm Ø spout for back entry only Upper spout 'P' pressure
Connecting Tube Reference		4mm spout = 2311-01 or 2311-08 2mm spout = 2311-03	4mm spout = 2311-01 or 2311-08 2mm spout = 2311-03
Temperature Range		-10°C to 85°C (Flow Solder 220°C for 5 Sec)	-10°C to 85°C (Flow Solder 220°C for 5 Sec)
Electrical Data			
Switch		Single Pole Normally Open	Single Pole Normally Open
Contact Rating Maximum		0.5A RES 250V ac (Silver contacts)	0.5A RES 250V ac (Silver Contacts)
UL		50mA RES 250V ac	50mA RES 250V ac
		(Maximum ratings may not be achieved at low pressure settings)	
Dry Switching Maximum Recommended Current		10mA 24V dc (UL)	10mA 24V dc (UL)
Body		Glass filled polyester	Glass filled polyester
Diaphragm		Silicone as standard	Silicone as standard
Contacts		Silver or gold plated copper pins	Silver or gold plated copper pins
Mechanical Life		1 x 10 ⁶ cycles	1 x 10 ⁶ cycles
Weight (grams)		8grms	8grms

6761/6763 Vacuum and Pressure Switch Range

A miniature, compact low pressure switch designed for direct fitting by solder pins to printed circuit boards. Both vacuum and pressure ports are provided making the unit ideal for differential switching. Typical applications are indicators, emergency cut-out and alarms, filter and low pressure/vacuum monitoring. The switch is made to order for specific applications, the actual operating pressures or vacuum being set during production. However, final adjustment may be made after installation by the slotted screw in the base. The body construction allows the two ports to be set at any angle to each other.

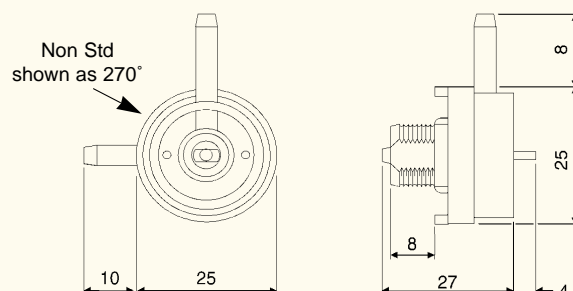

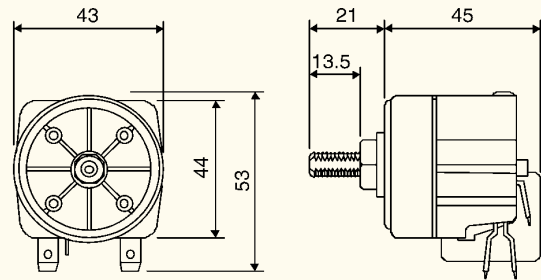
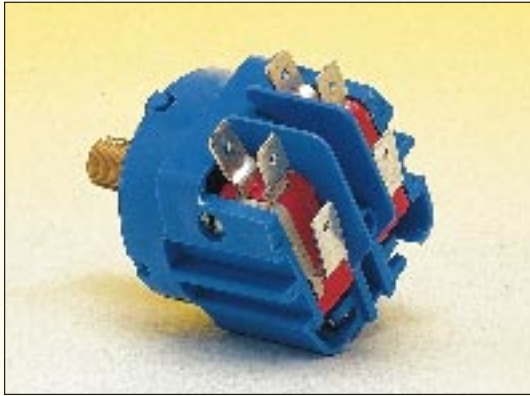

Benefits

- ❖ Switches set to specific rising or falling pressures
- ❖ UL recognised versions available
- ❖ High performance repeatability

- ❖ Single or double pole switching
- ❖ Customised settings available upon request
- ❖ Various connector options available

Silver Contact Microswitch Data

Average Life Expectancy	Mechanical	1.0 x 10 ⁶		
	Electrical	2.0 x 10 ⁵ @ 10A 1.0 x 10 ⁴ @ 21A		
Electrical Rating	Max. Electrical Load			
	Voltage	Res.	Ind.	(Pf 0.75 Motor)
AC	250V	21A		1HP
	250V	21A	8A	1HP
	125V	21A		
DC	6V	21A	21A	
	12V	15A	15A	
	24V	8A	7A	
	60V	1A	0.5A	
	110V	0.5A	0.1A	
	220V	0.25A	0.1A	

Model No	6742-20/30/40/50/60	6742-70/80/90
Electrical Switch Data	2 Pole change over	2 Pole Change over
Contact Rating	21 (8) A 250V ac	21 (8) A 250V ac
Pressure Connection	Brass 1/8" BSPT	Brass 1/8" BSPT
Setting Accuracy	± 10% as standard	± 10% as standard
Withstand Pressure	25 PSI or x 2	150 PSI 10 Bar
Temperature Range	-5°C to + 70°C	-5°C to + 70°C
Body Material	Nylon 12	Nylon 12
Diaphragm	Neoprene	Nitrile fabric reinforced fitted in brass pressure capsule
Spring	Spring steel	Spring steel
Weight	50gm	85gm

Gold Contact Microswitch Data

Average Life Expectancy	Mechanical	1.0 x 10 ⁶		
	Electrical	2.0 x 10 ⁵ @ 10A 1.0 x 10 ⁴ @ 21A		
Electrical Rating	Max. Electrical Load			
	Voltage	Res.	Ind.	(Pf 0.75 Motor)
AC	250V	0.1A	0.05	N/A
UL/CSA Only	125V	0.1A	-----	-----

Model No	Pressure Range		Differential (Fixed)
	P.S.I	Bar	
6742-20	1.5 - 3.5	0.10 - 0.24	See chart 1
6742-30	3.0 - 5.5	0.20 - 0.37	See chart 1
6742-40	5 - 10	0.34 - 0.68	See chart 1
6742-50	8 - 18	0.54 - 1.22	See chart 2
6742-60	16 - 30	1.08 - 2.04	See chart 2
6742-70	25 - 55	1.70 - 3.79	See chart 3
6742-80	45 - 75	3.1 - 5.17	See chart 3
6742-90	60 - 120	4.14 - 8.27	See chart 3

Switch Standards: EN 60730, EN 61058 and UL 508

Approvals Available: CE, BEAB, CSA, DEMCO, IMQ, KEMA, NEMCO, OVE, SEMCO, SET I, SEV, UL, VDE

NB

Herga do not accept liability for any pressure operated device used outside the pressure range specified by the company.

Special options are available for quantity orders

- ❖ Diaphragms in silicon rubber, nitrile, EPDM
- ❖ Switches with wide or close differentials
- ❖ Springs in stainless steel
- ❖ NPT connectors available

Suitability for use with different operating media

Pressure Medium	Diaphragms	
	6742/20/30/40 50 & 60	6742/70/80 & 90
Chemical Compatibility		
Acetone	✓	✓
Ammonia (Liquid)	✓	✓
Amyl Alcohol to 20°C	✓	✓
Automotive Brake Fluid	✓	✓
Beer	✓	✓
Benzyl Alcohol	✗	✓
Butane	✓	✓
Carbon Dioxide - Dry	✓	✓
Citric Acid	✓	✓
Copper Sulphate (Sol.)	✓	✓
Compressed Air	✓	✓
Cutting Oil	✓	✓
Diesel Oil	✓	✓
Detergent Solution	✓	✓
Fuel Oil	✓	✓
Glycol	✓	✓
Hydraulic Oil	✓	✓
Hydrogen	✓	✓
Lubricating Oil	✓	✓
Milk	✓	✓
Mineral Oil	✓	✓
Natural Gas	✓	✓
Nitric Acid (Dil.)	✗	✓
Oxygen to 70°C	✓	✓
Petrol	✓	✓
Plating Solution (Chrome)	✓	✓
Salt Water	✓	✓
Sewage	✓	✓
Sulphur Dioxide	✗	✓
Turpentine	✓	✓
Vinegar	✓	✓
Water	✓	✓

Key: ✓ = Recommended
 ✓ = Suitable with modification
 ✗ = Not suitable

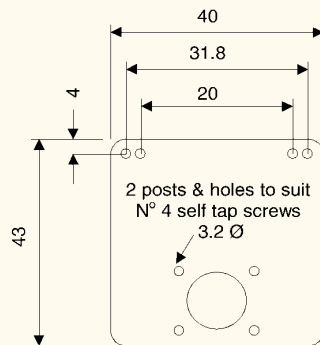

2mm thick mounting plate
 Part N° 3351-109
 for 6742-20 to 6742-60

Note:
 Longer screws will penetrate
 diaphragm chamber, please order
 part N° 2112-643-047 Qty 2

Alternative Pressure Connections 1/8" NPT Pressure Connector

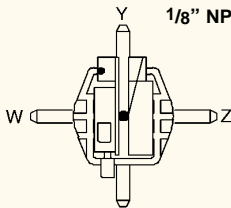

Non standard tube connection
 positions for 4mm Ø spout connection.
 Not recommended for pressure
 over 20 PSI

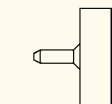

Back entry
 6.4mm Ø spout

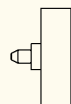

Back entry
 4mm Ø spout

6742-20 to 6742-60 only

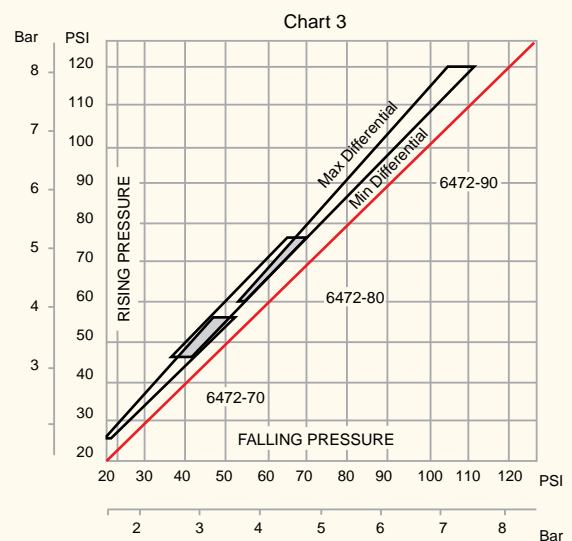
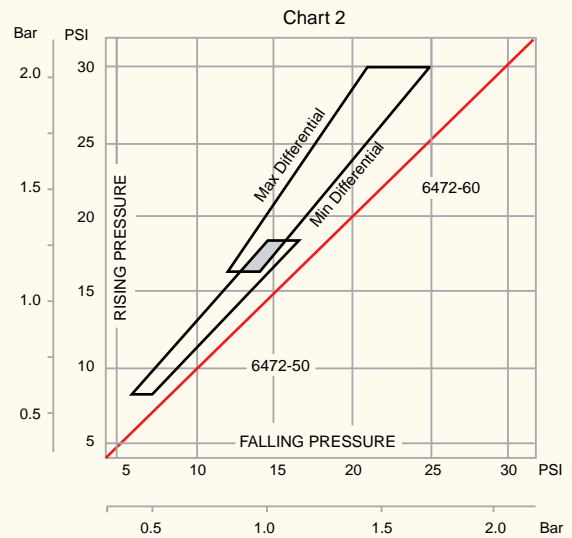
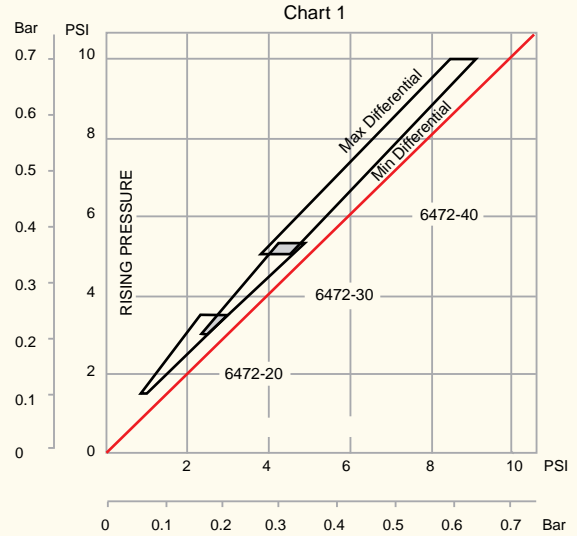

Note: Differentials are approximate

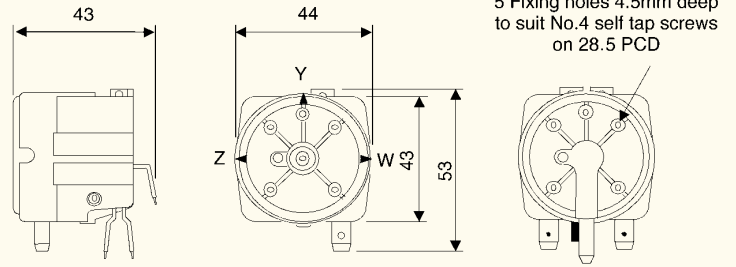

Benefits

- ❖ These switches have been designed primarily for the OEM manufacturer who requires low cost and high reliability
- ❖ UL recognised versions available

- ❖ The switches have excellent repeat accuracy
- ❖ Double pole switching available upon request
- ❖ Wide choice of microswitch options including tab configurations

Model No	6731-03	6731-06	6731-10
Electrical Switch	Single Pole change over	Single Pole change over	Single Pole change over
Contact Rating	3(1)A 250V ac	10(3)A 250V ac	21(8)A 250V ac
Pressure Connection	Side entry spout 4mm O/D	Side entry spout 4mm O/D	Side entry spout 4mm O/D
Setting Accuracy	± 10% as std	± 10% as std	± 10% as std
Withstand Pressure	25 PSI	25 PSI	25 PSI
Body Material	Nylon 12	Nylon 12	Nylon 12
Diaphragm	Neoprene	Neoprene	Neoprene
Spring	Spring steel	Spring steel	Spring steel
Weight	50gm	50gm	50gm

Model No	Pressure Range		Differential (Fixed)
	Inches Water	mm Water	
6731-03	1.5 - 7	40 - 180	See chart 1
6731-06	5 - 25	127 - 635	See chart 1
6731-10	20 - 55	510 - 1400	See chart 1

Special options are available for quantity orders

- ❖ Switches set to specific operating pressure, rising or falling
- ❖ Diaphragms in silicon rubber, nitrile, EPDM
- ❖ Switches with wide or close differentials
- ❖ Springs in stainless steel

Pressure Switches		6731-03		6731-06			6731-10		
Average Life Expectancy	Mechanical	2 x 10 ⁶		2 x 10 ⁶			1.0 x 10 ⁶		
	Electrical	0.2 x 10 ⁶ @ 1A		0.2 x 10 ⁶ @ 6A 50K @ 10A			0.2 x 10 ⁶ @ 10A 10K @ 21A		
Electrical Rating		Max Electrical Load		Max Electrical Load			Max Electrical Load		
	Voltage	Resistive	Inductive	Resistive	Inductive	Motor (Pf0.75)	Resistive	Inductive	Motor (Pf0.75)
AC	125V	3A	1A	10A	10A	0.5HP	21A	15A	1HP
	250V	3A	1A	10A	10A	0.5HP	21A	15A	2HP
DC	6V	3A	1A	10A	10A		21A	21A	
	12V	3A	1A	5A	3A		15A	15A	
	24V	1A	0.5A	5A	3A		8A	7A	
	60V	1A	0.5A	1A	0.5A		1A	0.5A	
	110V	0.5A	0.2A	0.5A	0.2A		0.5A	0.2A	
	220V	0.25	0.1A	0.25A	0.1A		0.25A	0.1A	

Switch Standards: EN 60730, EN 61058 and UL 508

Approvals Available CE, BEAB, CSA, DEMCO, IMQ, KEMA, NEMCO, OVE, SEMCO, SET I, SEV, UL, VDE. Approved to BS 3955 part III

Note: Dry Switching

If switching low power circuits, low current (4 to 100 milliamperes) and low voltage (below 30V), consult herga for special switches.

NB - Herga do not accept liability for any pressure operated device used outside the pressure range specified by the company.

Suitability for use with different operating media

Pressure Medium	Diaphragms
Chemical Compatibility	6731
Acetone	✓
Ammonia (Liquid)	✓
Amyl Alcohol to 20°C	✓
Automotive Brake Fluid	✓
Beer	✓
Benzyl Alcohol	✗
Butane	✓
Carbon Dioxide - Dry	✓
Citric Acid	✓
Copper Sulphate (Sol.)	✓
Compressed Air	✓
Cutting Oil	✓
Diesel Oil	✓
Detergent Solution	✓
Fuel Oil	✓
Glycol	✓
Hydraulic Oil	✓
Hydrogen	✓
Lubricating Oil	✓
Milk	✓
Mineral Oil	✓
Natural Gas	✓
Nitric Acid (Dil.)	✗
Oxygen to 70°C	✓
Petrol	✓
Plating Solution (Chrome)	✓
Salt Water	✓
Sewage	✓
Sulphur Dioxide	✗
Turpentine	✓
Vinegar	✓
Water	✓

Key: ✓ = Recommended
 ✓ = Suitable with modification
 ✗ = Not suitable

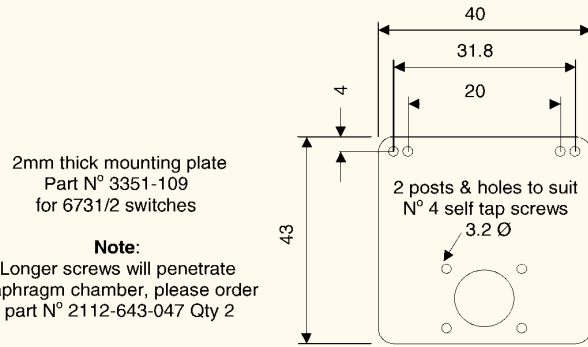

Note:
 Longer screws will penetrate diaphragm chamber, please order part N° 2112-643-047 Qty 2

Alternative Pressure Connections

Back Entry 1/8" BSPT and NPT Pressure Connectors

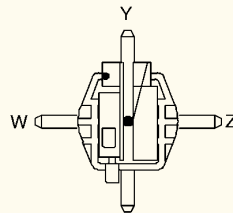

Non standard tube connection positions for 4mm Ø spout connection. Not recommended for pressure over 20 PSI

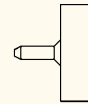

Back entry 6.4mm Ø spout

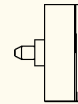

Back entry 4mm Ø spout

Chart 1

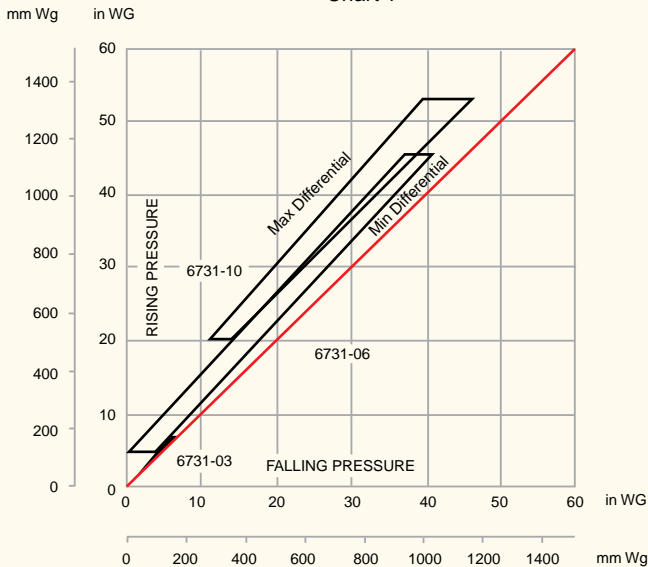

Note: Differentials are approximate

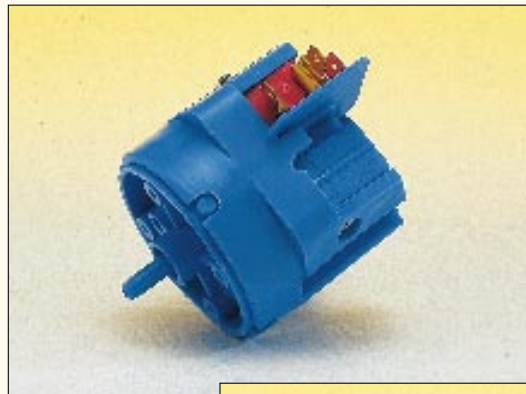

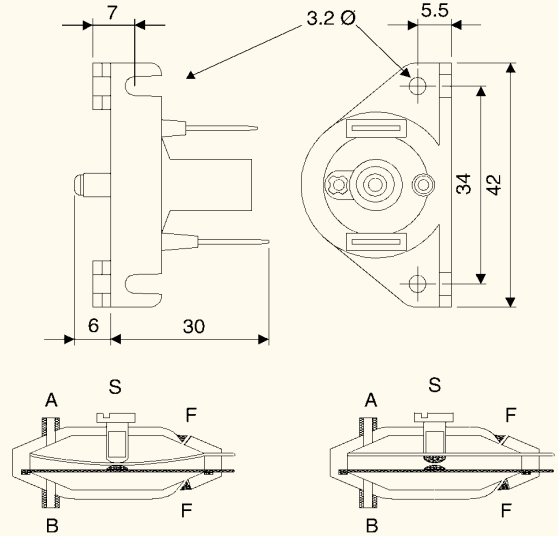
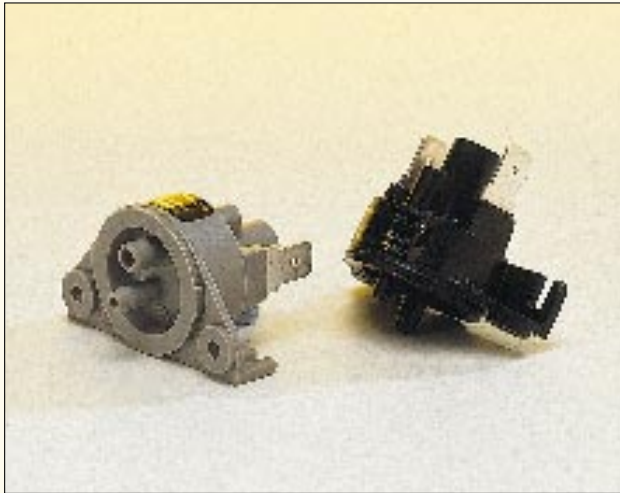

Benefits

- ❖ Sensitive versatile switch - ideal for long tube length applications
- ❖ Normally open or normally closed contact configuration
- ❖ Ideal for switching low power circuits

- ❖ Bleed versions available for temperature compensation
- ❖ Easily adjustable settings
- ❖ Custom pressure, vacuum and bleed settings available upon request

6753 - -

1. Model Number

2. Operation

- A Normally Open - Pressure
- B Normally Closed - Vacuum

3. Bleed Adjuster Options

- A Bleed A side only, Vacuum N/O to N/C, Pressure N/C to N/O
- B Bleed B side only, Vacuum N/O to N/C, Pressure N/C to N/O
- C Bleed both sides Vacuum / Pressure
- D No bleed variant either side Vacuum / Pressure

4. Bleed Setting

- A 100 - 300 cc/Min Factory Setting
- J No bleed setting

5. Pressure Setting

- | | |
|-----------------------|--------------------|
| A 2.25" WG ± 0.5" Std | B 2" WG ± 0.5" |
| C 3" WG ± 0.5" | D 4" WG ± 0.5" |
| E 6" WG ± 10% | F 8" WG ± 10% |
| G 10" WG ± 10% | H 12" WG ± 10% |
| J 14" WG ± 10% | K 16" WG ± 0 - 10% |

6. Packaging Options

- A Vacuum Form Tray (100 off volumes - ideal for OEM applications)
- B Poly Bag (individual)

Technical Data	
Pressure/Vacuum range minimum	25mm (1 in) Wg
maximum	400mm (16 ins) Wg
Maximum Differential	400mm (16 ins) Wg
Pressure Standard Factory Setting	50mm (2.25 ins) Wg (Contacts Normally Open) Other settings available see note ²⁾
Maximum Differential Between Pressure Connection	0.34 Bar (5 PSI)
Body Withstand Pressure	1.0 Bar (14.7 PSI)
Air Bleed Version	See choice options 3 & 4, other settings available, see note ³⁾
Flow Rate Litre / Min	Standard 100 - 300 cc/Min @ 5 PSI
Connection Position	Base see note ²⁾
Pressure Connection	4mm dia spouts For reducing connectors, please refer to accessories page
Connecting Tube Reference	2311-08 or 2311-01
Temperature Range	-5°C to 50°C

Electrical Data	
Switch	Single pole, N/Open / N/Closed
Contact Rating Maximum	0.5A RES 250V ac (Maximum ratings may not be achieved at low pressure settings)
Dry Switching Minimum Current	5mA 4V dc
Body	Glass filled nylon 12
Diaphragm	Neoprene
Contacts	Gold plated silver mounted on phosphor-bronze blades
Contact Resistance	0.05 Ohms
Mechanical Life	1 x 10 ⁶ cycles
Weight (grams)	10grms

6753 Pressure Switch Range

For very sensitive pressure, vacuum and differential pressure switching.

The 6753 range of switches provide a high specification in a small, versatile body shell. Great care has been taken in the switch unit design, keeping the moving mass and therefore inertia to a minimum. This means that it can operate at a high cycle rate with low pressure, vacuum or pressure differential. This design feature can be used when measuring pressure pulses such as on component counting applications and used with herga Safe Edges. The switch will operate very rapidly keeping the switch delay to a minimum.

- 1) For good repeatable switching, the contacts are gold plated on solid silver. The electrical rating of the switch is dependent on the contact pressure. This pressure is dependent on the air pressure. Thus, for very sensitive setting the permissible switching current will be lower than normal.
- 2) The standard switch can be adjusted to give normally closed or normally open contacts depending on the application. For operation on pressure with normally closed contacts, connect to air connection 'A' and screw in sensitivity adjusting screw 'S' until contacts are normally closed. For operation on pressure with normally open contacts, connect to air connection 'B' and set with contacts normally open.
- 3) A separate version, (see bleed options), is provided with adjustable air bleeds on both sides of the diaphragm. These air bleeds are adjusted to a level which is suitable for most applications involving safe edges or elbows, and prevent pressure or vacuum building up inside when the ambient temperature or atmospheric pressure changes.

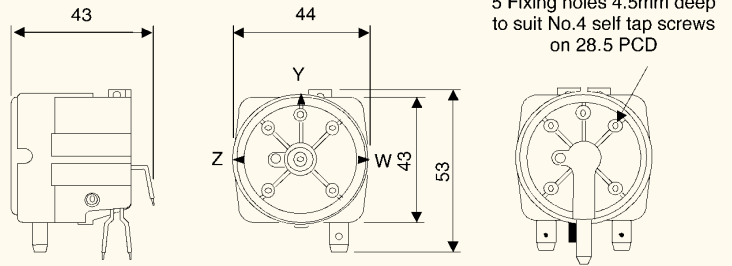
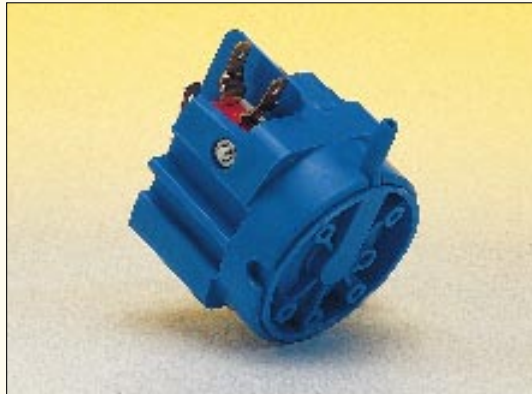

Benefits

- ❖ These switches have been designed primarily for the OEM manufacturer who requires low cost and high reliability
- ❖ UL recognised versions available

- ❖ The switches have excellent repeat accuracy
- ❖ Double pole switching available upon request
- ❖ Wide choice of microswitch options available including tab configurations

Model No	6721-03	6721-06	6721-20/30/40
Electrical Switch Data	Single Pole change over	Single Pole change over	Single Pole change over
Contact Rating	3(1)A 250V ac	10(3)A 250V ac	21(8)A 250V ac
Vacuum Connection	Side entry spout 4mm O/D	Side entry spout 4mm O/D	Side entry spout 4mm O/D
Setting Accuracy	± 10% std	± 10% std	± 10% std
Temperature Range	-5°C to + 70°C	-5°C to + 70°C	-5°C to + 70°C
Body Material	Nylon 12	Nylon 12	Nylon 12
Diaphragm	Neoprene	Neoprene	Neoprene
Spring (in Vacuum Cavity)	Spring steel ¹⁾	Spring steel ¹⁾	Spring steel ¹⁾

Model No	Vacuum Range		Differential (Fixed)
	Inches Water	mm Water	
6721-03	3 - 8	75 - 200	See chart 1
6721-06	7 - 15	180 - 380	See chart 1
6721-20	13 - 32	330 - 810	See chart 1
6721-30	28 - 80	710 - 2030	See chart 2
6721-40	75 - 270	1900 - 6860	See chart 2

Special options are available for quantity orders

- ❖ Switches set to specific operating vacuum, rising or falling
- ❖ Diaphragms in silicon rubber, nitrile, EPDM
- ❖ Switches with wide or close differentials
- ❖ Springs in stainless steel

Note: The spring is fitted in the vacuum cavity in contact with the media

Pressure Switches		6731-03		6731-06			6731-10		
Average Life Expectancy	Mechanical	2 x 10 ⁶		2 x 10 ⁶			1.0 x 10 ⁶		
	Electrical	0.2 x 10 ⁶ @ 1A		0.2 x 10 ⁶ @ 6A 50K @ 10A			0.2 x 10 ⁶ @ 10A 10K @ 21A		
Electrical Rating		Max Electrical Load		Max Electrical Load			Max Electrical Load		
	Voltage	Resistive	Inductive	Resistive	Inductive	Motor (Pf0.75)	Resistive	Inductive	Motor (Pf0.75)
	125V	3A	1A	10A	10A	0.5HP	21A	15A	1HP
AC	250V	3A	1A	10A	10A	0.5HP	21A	15A	2HP
DC	6V	3A	1A	10A	10A		21A	21A	
	12V	3A	1A	5A	3A		15A	15A	
	24V	1A	0.5A	5A	3A		8A	7A	
	60V	1A	0.5A	1A	0.5A		1A	0.5A	
	110V	0.5A	0.2A	0.5A	0.2A		0.5A	0.2A	
	220V	0.25A	0.1A	0.25A	0.1A		0.25A	0.1A	
Switch Standards:		EN 60730, EN 61058 and UL 508							
Approvals Available		CE, BEAB, CSA, DEMCO, IMQ, KEMA, NEMCO, OVE, SEMCO, SET I, SEV, UL, VDE. Approved to BS 3955 part III							

Note: Dry Switching

If switching low power circuits, low current (4 to 100 milliamperes) and low voltage (below 30V), consult herga for special switches.

NB - Herga do not accept liability for any vacuum operated device used outside the pressure range specified by the company.

Suitability for use with different operating media

Vacuum Medium	Diaphragms
Chemical Compatibility	6721
Acetone	✓
Ammonia (Liquid)	✓
Amyl Alcohol to 20°C	✓
Automotive Brake Fluid	✓
Beer	✓
Benzyl Alcohol	✗
Butane	✓
Carbon Dioxide - Dry	✓
Citric Acid	✓
Copper Sulphate (Sol.)	✓
Compressed Air	✓
Cutting Oil	✓
Diesel Oil	✓
Detergent Solution	✓
Fuel Oil	✓
Glycol	✓
Hydraulic Oil	✓
Hydrogen	✓
Lubricating Oil	✓
Milk	✓
Mineral Oil	✓
Natural Gas	✓
Nitric Acid (Dil.)	✗
Oxygen to 70°C	✓
Petrol	✓
Plating Solution (Chrome)	✓
Salt Water	✓
Sewage	✓
Sulphur Dioxide	✗
Turpentine	✓
Vinegar	✓
Water	✓

Key: ✓ = Recommended
 ✓ = Suitable with modification
 ✗ = Not suitable

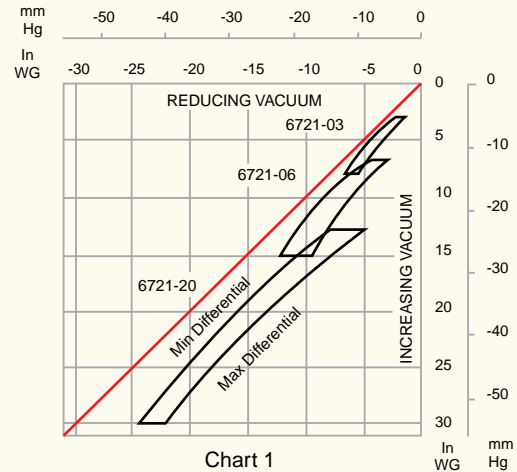

Chart 1

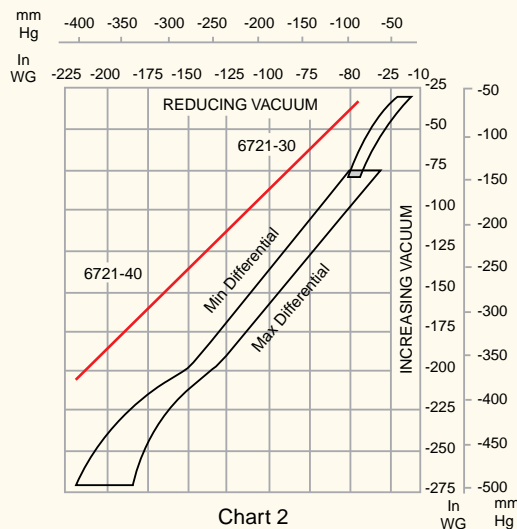
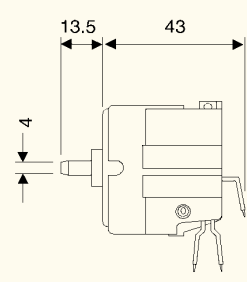
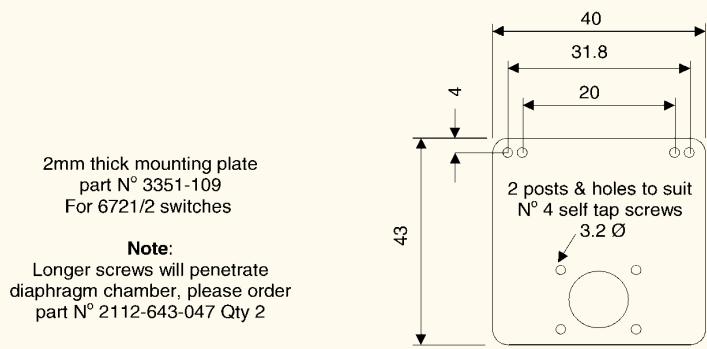

Chart 2

Note: Differentials are approximate



Back entry option available

Alternative Vacuum Connections Back entry 1/8" BSPT and NPT Connectors

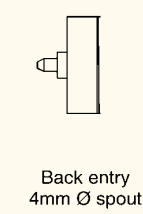
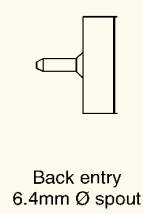
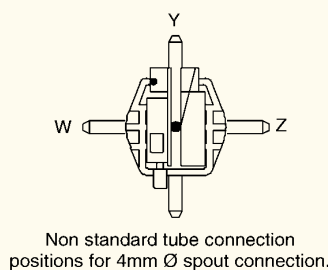

Pressure Conversion Table



P.S.I	in/H ₂ O	in/Hg	mm/H ₂ O	mm/Hg	kg/cm ²	bar	mbar	Pa	kPa
1.0	27.71	2.036	703.1	51.75	.0703	.0689	68.95	6895	6.895
1.1	30.45	2.240	773.4	56.89	.0773	.0758	75.84	7584	7.584
1.2	33.22	2.443	843.7	62.06	.0844	.0827	82.74	8274	8.274
1.3	35.98	2.647	914.0	67.23	.0914	.0896	89.63	8963	8.963
1.4	38.75	2.850	984.3	72.40	.0984	.0965	96.52	9652	9.652
1.5	41.52	3.054	1055	77.57	.1055	.1034	103.4	10340	10.34
1.6	44.29	3.258	1125	82.74	.1125	1103	110.3	11030	11.03
1.7	47.06	3.461	1195	87.92	.1195	.1172	117.2	11720	11.72
1.8	49.82	3.665	1266	93.09	.1266	1241	124.1	12410	12.41
1.9	52.59	3.868	1336	98.26	.1336	1310	131.0	13100	13.10
2.0	55.36	4.072	1406	103.4	.1406	.1379	137.9	13790	13.79
2.1	58.13	4.276	1476	108.6	.1476	.1448	144.8	14480	14.48
2.2	60.90	4.479	1547	113.8	.1547	.1517	151.7	15170	15.17
2.3	63.67	4.683	1617	118.9	.1617	.1586	158.6	15860	15.86
2.4	66.43	4.886	1687	124.1	.1687	.1655	165.5	16550	16.55
2.5	69.20	5.090	1758	129.3	.1758	.1724	172.4	17240	17.24
2.6	71.97	5.294	1828	134.5	.1828	.1793	179.3	17930	17.93
2.7	74.74	5.497	1898	139.6	.1898	.1862	186.2	18620	18.62
2.8	77.51	5.701	1969	144.8	.1968	.1930	193.0	19300	19.30
2.9	80.27	5.904	2039	150.0	.2039	.1999	199.9	19990	19.99
3.0	83.04	6.108	2109	155.1	.2109	.2068	206.8	20680	20.68
3.1	85.81	6.312	2180	160.3	.2180	.2137	213.7	21370	21.37
3.2	88.58	6.515	2250	165.5	.2250	.2206	220.6	22060	22.06
3.3	91.35	6.719	2320	170.7	.2320	.2275	227.5	22750	22.75
3.4	94.11	6.922	2390	175.8	.2390	.2344	234.4	23440	23.44
3.5	96.88	7.126	2461	181.0	.2461	.2413	241.3	24130	24.13
3.6	99.65	7.330	2531	186.2	.2531	.2482	248.2	24820	24.82
3.7	102.4	7.533	2601	191.3	.2601	.2551	255.1	25510	25.51
3.8	105.2	7.737	2672	196.5	.2672	.2620	262.0	26200	26.20
3.9	108.0	7.940	2742	201.7	.2742	.2689	268.9	26890	26.89
4.0	110.7	8.144	2812	206.9	.2812	.2758	275.8	27580	27.58
4.1	113.5	8.348	2883	212.0	.2883	.2827	282.7	28270	28.27
4.2	116.3	8.551	2953	217.2	.2953	.2896	289.6	28960	28.96
4.3	119.0	8.775	3023	222.4	.3023	.2965	296.5	29650	29.65
4.4	121.8	8.958	3094	227.5	.3094	.3034	303.4	30338	30.34
4.5	124.6	9.162	3164	232.7	.3164	.3103	310.3	31030	31.03
4.6	127.3	9.366	3234	237.9	.3234	.3172	317.2	31720	31.72
4.7	130.1	9.569	3304	243.1	.3304	.3240	324.0	32400	32.40
4.8	132.9	9.773	3375	248.2	.3375	.3310	331.0	33100	33.10
4.9	135.6	9.976	3445	253.4	.3445	.3378	337.8	33780	33.78
5.0	138.4	10.18	3515	258.6	.3515	.3447	344.7	34470	34.47
5.1	141.2	10.38	3586	263.7	.3586	.3516	351.6	35160	35.16
5.2	143.9	10.59	3656	268.9	.3656	.3585	358.5	35850	35.85
5.3	146.7	10.79	3726	274.1	.3726	.3654	365.4	36540	36.54
5.4	149.5	10.99	3797	279.3	.3797	.3723	372.3	37230	37.23
5.5	152.2	11.20	3867	284.4	.3867	.3792	379.2	37920	37.92

P.S.I	in/H ₂ O	in/Hg	mm/H ₂ O	mm/Hg	kg/cm ²	bar	mbar	Pa	kPa
5.6	155.0	11.40	3937	289.6	.3937	.3861	386.1	38610	38.61
5.7	157.8	11.60	4008	294.8	.4007	.3930	393.0	39300	39.30
5.8	160.5	11.81	4078	299.9	.4078	.3999	399.9	39990	39.99
5.9	163.3	12.01	4148	305.1	.4148	.4068	406.8	40680	40.68
6.0	166.1	12.22	4218	310.3	.4218	.4137	413.7	41370	41.37
6.1	168.8	12.42	4289	315.5	.4289	.4206	420.6	42060	42.06
6.2	171.6	12.62	4359	320.6	.4359	.4275	427.5	42750	42.75
6.3	174.4	12.83	4429	325.8	.4429	.4344	434.4	43440	43.44
6.4	177.2	13.03	4500	331.0	.4500	.4413	441.3	44130	44.13
6.5	179.9	13.23	4570	336.1	.4570	.4482	448.2	44820	44.82
6.6	182.7	13.44	4640	341.3	.4640	.4550	455.0	45500	45.50
6.7	185.5	13.64	4711	346.5	.4710	.4619	461.9	46190	46.19
6.8	188.2	13.84	4781	351.7	.4781	.4688	468.8	46880	46.88
6.9	191.0	14.05	4851	356.8	.4851	.4757	475.7	47570	47.57
7.0	193.8	14.25	4922	362.0	.4921	.4826	482.6	48260	48.26
7.1	196.5	14.46	4992	367.2	.4992	.4895	489.5	48950	48.95
7.2	199.3	14.66	5062	372.3	.5062	.4964	496.4	49640	49.64
7.3	202.1	14.86	5132	377.5	.5132	.5033	503.3	50330	50.33
7.4	204.8	15.07	5203	382.7	.5203	.5102	510.2	51020	51.02
7.5	207.6	15.27	5273	387.9	.5273	.5171	517.1	51710	51.71
7.6	210.4	15.47	5343	393.0	.5343	.5240	524.0	52400	52.40
7.8	215.9	15.88	5484	403.4	.5484	.5378	537.8	53780	53.78
8.0	221.4	16.29	5625	413.7	.5625	.5516	551.6	55160	55.16
8.2	227.0	16.70	5765	424.1	.5765	.5654	565.4	56540	56.54
8.4	232.5	17.10	5906	434.4	.5906	.5792	579.2	57920	57.92
8.6	238.0	17.51	6047	444.7	.6046	.5929	592.9	59290	59.29
8.8	243.6	17.92	6187	455.1	.6187	.6067	606.7	60670	60.67
9.0	249.1	18.32	6328	465.4	.6328	.6205	620.5	62050	62.05
9.2	254.7	18.73	6468	475.8	.6468	.6343	634.3	63430	63.43
9.4	260.2	19.14	6609	486.1	.6609	.6481	648.1	64810	64.81
9.6	265.7	19.54	6750	496.5	.6749	.6619	661.9	66190	66.19
9.8	271.3	19.95	6890	506.8	.6890	.6757	675.7	67570	67.57
10.0	276.8	20.36	7031	517.1	.7031	.6895	689.5	68950	68.95
11.0	304.5	22.40	7734	568.9	.7734	.7584	758.4	75840	75.84
12.0	332.2	24.43	8437	620.6	.8437	.8274	827.4	82740	82.74
13.0	359.8	26.47	9140	672.3	.9140	.8963	896.3	89630	89.63
14.0	387.5	28.50	9843	724.0	.9843	.9652	965.2	96520	96.52
14.7	406.9	29.93	10340	760.2	1.033	1.014	1014	101400	101.4
15.0	415.2	30.54	10550	775.7	1.055	1.034	1034	103400	103.4
16.0	442.9	32.58	11250	827.4	1.125	1.103	1103	110300	110.3
17.0	470.6	34.61	11950	879.1	1.195	1.172	1172	117200	117.2
18.0	498.2	36.65	12660	930.9	1.265	1.241	1241	124100	124.1
19.0	525.9	38.68	13360	982.6	1.336	1.310	1310	131000	131.0
20.0	553.6	40.72	14060	1034	1.406	1.379	1379	137900	137.9
25.0	692.0	50.90	17580	1293	1.758	1.724	1724	172400	172.4

Pressure Conversions

Lbf/in² = Pounds force per square inch (psi)
 1 psi = 27.6804 in/H₂O
 1 psi = 2.03602 in/Hg
 1 psi = 68.9476 mbar
 1 psi = 703.082 mm/H₂O
 1 psi = 0.0689 bar
 1 in/H₂O = 25.4 mm/H₂O
 1 in/H₂O = 1.86832 mm/Hg
 1 in/H₂O = 2.49089

Flow

dm³/s = Cubic decimetres per second
 ft³/Min = Cubic feet per minute
 l/Min = Litres per minute
 1dm³/s = 2.119 ft³/Min
 1dm³/s = 60 Litres/Min
 1Lt/Min = 0.0353 ft³/Min

Liquid











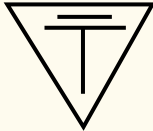











ml = Millilitre
 Fl oz = Fluid Ounce
 1ml = 0.0352 Fl/oz
 1 Litre = 0.21998 UK
 Gallon

Force

N = Newton
 Lbf = Pounds force
 Kgf = Kilogram force
 1 N = 0.225Lbf
 1 N = 0.102Kgf

Weight

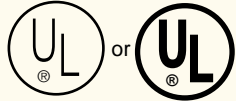
Kg = Kilogram
 Lb = Pound
 1Kg = 2.2045Lb

<u>Country</u>	<u>Agency</u>	<u>Mark</u>	<u>Country</u>	<u>Agency</u>	<u>Mark</u>
Australia	SAA		Japan	MITI	
Austria	OVE		Netherlands	KEMA	
Belgium	CEBEC		New Zealand	SECV SECQ SECWA EANSW ETSA HECT SANZ	
Canada	CSA				
Denmark	DEMKO		Norway	NEMKO	
Europe	MANY		Republic of South Africa	SABS	
Finland	FEI		Sweden	SEMKO	
France	UTE		Switzerland	SEV	
Germany	VDE		United Kingdom	ASTA	
				BSI	
India	ISI			BEAB	
Ireland	IIRS		United States	UL	
Italy	IMQ				

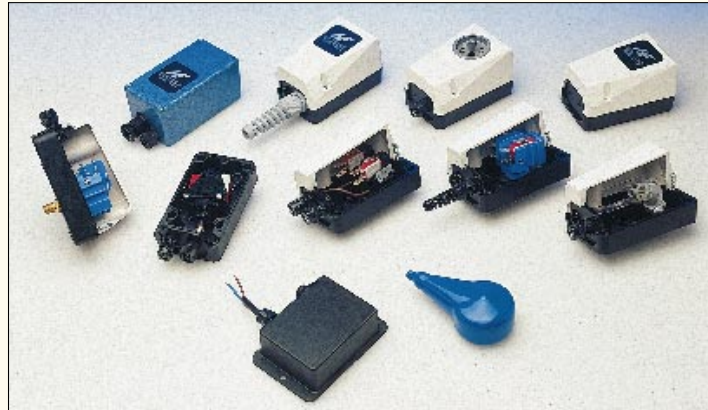

Benefits

- ❖ IP40 and IP67 Housings with rear fixing positions
- ❖ Variations of air or electrical connections
- ❖ Unlimited options available - contact herga with your requirements

- ❖ Back entry versions for pressure switch connections
- ❖ Available for all herga switching systems
- ❖ Custom designed labels and housing colours available for volume OEM requirements

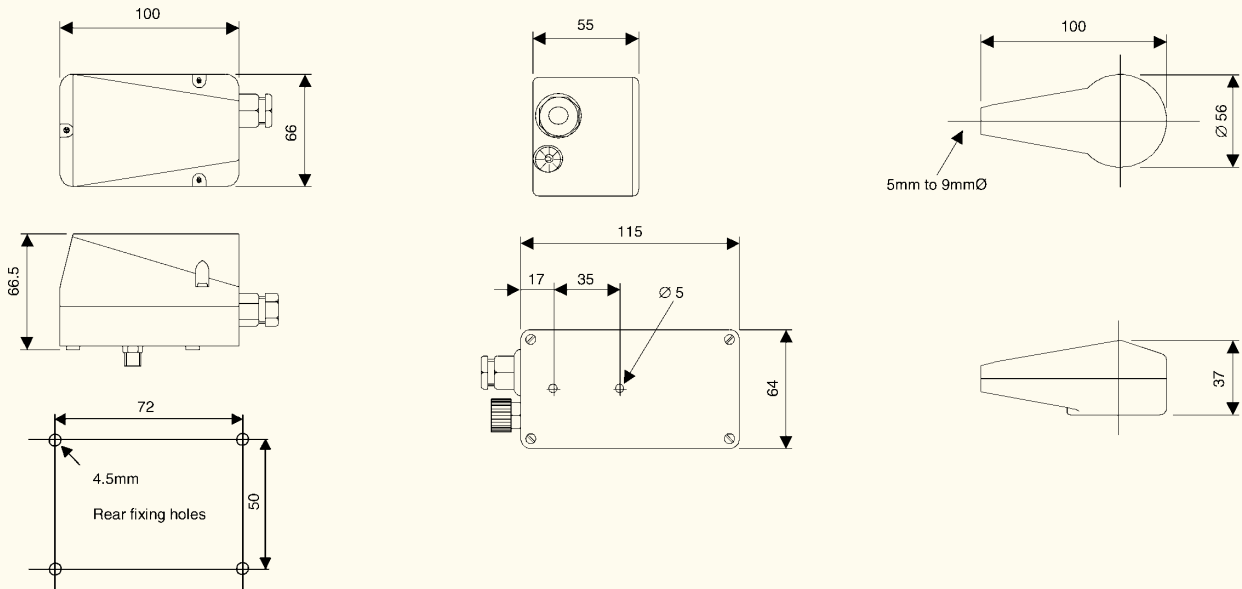

Part Number: 6819-00 Variants

The most economical and compact housing, produced especially for hergair switches. Double insulated sealed enclosure is moulded in two tone black and white ABS as standard. The lid has an integral rubber sealing gasket and captive screws. Mounting holes and lid fixing screws are outside the seal, thus preventing the ingress of moisture and making the box waterproof to IP65.

The standard 6819-00 housing is supplied with a cable gland for cable diameter 5mm to 7mm and a type 6418-00 air tube connector is fitted.

The housing is suitable for all airswitches except model 6806.

Part Number: 6816-00 Variants

Diecast aluminium housing for airswitch types except 6806 models. Finished in blue stove enamel. Ideal for use where electrical screening is required.

Other colour variants are available upon request as are specified fixing positions to suit your requirements.

Where a number of airswitches are to be fitted in one box, herga can supply a variety of special boxes complete with multi-way air connectors and electrical connections as required.

Note:

Herga can offer many other variants of electrical housings in size and colour up to IP67. We also manufacture world-wide (plug in) switch housings with or without cordsets in conjunction with our airswitching systems. Please contact us with your specific requirements.

Part Number: 6819-01

Blue flexible PVC protective boot for air and pressure switch types 6721, 6731, 6741, 6861, 6863 and 6869.

Covers all electrical connections and grips round outside of switch body. Can be used with cable 5mm to 9mm diameter.

We recommend a cable restraint is used in connection with this part.

Rapid Response Form (Photostat and fax back)



It is our goal to give you a response within 24 hours. By completing this form it will help us to help you!
Thank you.

CUSTOMER			
CONTACT NAME		TEL:	FAX:

_____ PRESSURE _____ VACUUM

INDUSTRY: MEDICAL POOL & SPA CHEMICAL/PROCESS INDUSTRIAL OTHER _____

CLASSIFICATION: OEM DISTRIBUTOR / RESELLER END USER OTHER _____

REQUIREMENTS: _____ PRESSURE. _____ VACUUM. _____ DIFFERENTIAL PRESSURE.

IF PRESSURE OR VACUUM MEASURED GAUGE (AS IN CATALOGUE) OR ABSOLUTE? _____

_____ INCHES WG _____ PSI GAUGE OPERATING RANGE: _____ TO _____ ± _____

HERGA TO SET WE WILL SET ON RISING ON FALLING

MAX PRESSURE/VACUUM UNIT WILL BE SUBJECTED TO _____ SETTING PREFERENCE ± _____

MAX DIFFERENTIAL (DIFF. BETWEEN RISE & FALL) _____ MIN DIFFERENTIAL _____

MEDIA GAS _____ TEMPERATURE _____ AMBIENT _____ TO _____

LIQUID _____ TEMPERATURE _____ MEDIA _____ TO _____

ELECTRICAL: VOLTS _____ AC _____ / _____ DC MAX CURRENT: AMPS _____ HP _____

_____ RESISTIVE _____ INDUCTIVE LOAD DESCRIPTION _____

APPROVAL NEEDED: UL CSA OTHER _____

CONTACT CONFIGURATION: SINGLE POLE DOUBLE POLE GOLD CONTACT

MECHANICAL: MOUNTING PREFERENCE 1/8" BSPT BRASS 1/8" BSPT STAINLESS SIDE SPOUT CENTRE SPOUT

1/8" NPT BRASS 1/8" NPT STAINLESS PCB MOUNT OTHER _____

APPLICATION (WHAT WILL SWITCH CONTROL?) _____

QUANTITY REQUIRED FOR PROTOTYPE? _____ REQUIRED DATE _____

ANNUAL PRODUCTION QUANTITY? _____ START DATE _____

CURRENT SWITCH USED? _____ PRICE RANGE _____

ANY PROBLEMS WITH PRESENT UNIT? _____

