

## Power SMD LED PLCC2 Plus

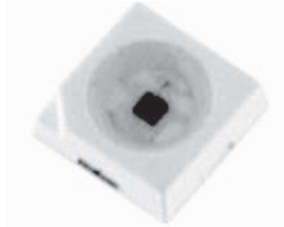

22068

### FEATURES

- High efficient AlInGaP technology
- Compact package outline 3.5 mm x 3.5 mm x 1.2 mm
- Angle of half intensity  $\varphi = \pm 60^\circ$
- Luminous intensity and color categorized per packing unit
- Luminous intensity ratio per packing unit  $\Phi_{\min.}/\Phi_{\max.} < 1.6$
- ESD-withstand voltage: up to 2 kV (HBM) according to JESD22-A114-B
- Preconditioning: according to JEDEC level 2a
- Compatible with IR-reflow soldering profiles according to J-STD-020
- AEC-Q101 qualified
- Compliant to RoHS directive 2002/95/EC and in accordance to WEEE 2002/96/EC
- Find out more about Vishay's Automotive Grade Product requirements at: [www.vishay.com/applications](http://www.vishay.com/applications)



### DESCRIPTION

The VLMR51..., VLMK51..., and VLMY51.. LED series in PLCC2 plus package are an advanced product in terms of high luminous flux and low thermal resistance. In combination with the small package outline (3.5 mm x 3.5 mm x 1.2 mm) the PLCC2 plus is an ideal choice for backlighting, signage, exterior and interior automotive lighting as well as decorative lighting.

### PRODUCT GROUP AND PACKAGE DATA

- Product group: LED
- Package: PLCC2 plus
- Product series: SMD power
- Angle of half intensity:  $\pm 60^\circ$

### APPLICATIONS

- Interior and exterior automotive lighting: dashboard, brake lights, turn lights, backlightin
- Signal and symbol luminaire
- Decorative lighting
- Architectural lighting
- Backlighting: LCDs, switches, keys, illuminated advertising
- Marker lights
- Traffic lights

### PARTS TABLE

| PART            | COLOR, LUMINOUS FLUX                                | TECHNOLOGY WAVELENGTH |
|-----------------|---|-----------------------|
| VLMR51Y1Z1-GS08 | Red, $I_V = (2850 \text{ to } 5600) \text{ mcd}$    | AllnGaP on Si         |
| VLMK51Y1Z1-GS08 | Amber, $I_V = (2850 \text{ to } 5600) \text{ mcd}$  | AllnGaP on Si         |
| VLMY51Y2Z2-GS08 | Yellow, $I_V = (3550 \text{ to } 7150) \text{ mcd}$ | AllnGaP on Si         |

**ABSOLUTE MAXIMUM RATINGS** ( $T_{amb} = 25\text{ }^{\circ}\text{C}$ , unless otherwise specified)  
**VLMR51..., VLMK51..., VLMY51...**

| PARAMETER                                    | TEST CONDITION   | SYMBOL      | VALUE         | UNIT               |
|--|--|-------------|---------------|--------------------|
| Reverse voltage                              | $I_R = 10\text{ }\mu\text{A}$                              | $V_R$       | 12            | V                  |
| DC forward current                           |  | $I_F$       | 200           | mA                 |
| Surge forward current                        | $t_p \leq 10\text{ }\mu\text{s}$                           | $I_{FSM}$   | 1000          | mA                 |
| Power dissipation                            |  | PV          | 530           | mW                 |
| Junction temperature                         |  | $T_{jmax.}$ | 125           | $^{\circ}\text{C}$ |
| Operating temperature range                  |  | $T_{amb}$   | - 40 to + 100 | $^{\circ}\text{C}$ |
| Storage temperature range                    |  | $T_{stg}$   | - 40 to + 100 | $^{\circ}\text{C}$ |
| Thermal resistance junction/<br>solder point |  | $R_{thJS}$  | 50            | K/W                |
| Thermal resistance junction/<br>ambient      | Mounted on PC board<br>total Cu area > 900 mm <sup>2</sup> | $R_{thJA}$  | 100           | K/W                |

**OPTICAL AND ELECTRICAL CHARACTERISTICS** ( $T_{amb} = 25\text{ }^{\circ}\text{C}$ , unless otherwise specified)  
**VLMR51..., RED**

| PARAMETER                                | TEST CONDITION   | PART       | SYMBOL                | MIN. | TYP.     | MAX. | UNIT  |
|--|--|------------|-----------------------|------|----------|------|-------|
| Luminous intensity                       | $I_F = 140\text{ mA}$  | VLMR51Y1Z1 | $I_V$                 | 2850 |          | 5600 | mcd   |
| Luminous flux                            | $I_F = 140\text{ mA}$  | VLMR51Y1Z1 | $\Phi_V$              |      | 10.6     |      | lm    |
| Dominant wavelength                      | $I_F = 140\text{ mA}$  |            | $\lambda_{dom}$       | 620  |          | 630  | nm    |
| Angle of half intensity                  | $I_F = 140\text{ mA}$  |            | $\varphi$             |      | $\pm 60$ |      | deg   |
| Forward voltage                          | $I_F = 140\text{ mA}$  |            | $V_F$                 | 1.9  | 2.2      | 2.65 | V     |
| Temperature coefficient $I_V$            | $I_F = 140\text{ mA}$ ,<br>$0\text{ }^{\circ}\text{C} \leq T \leq 100\text{ }^{\circ}\text{C}$ |            | $TC_{I_V}$            |      | - 26.8   |      | mcd/K |
| Temperature coefficient $V_F$            | $I_F = 140\text{ mA}$ ,<br>$0\text{ }^{\circ}\text{C} \leq T \leq 100\text{ }^{\circ}\text{C}$ |            | $TC_{V_F}$            |      | - 3.5    |      | mV/K  |
| Temperature coefficient $\lambda_{dom.}$ | $I_F = 140\text{ mA}$ ,<br>$0\text{ }^{\circ}\text{C} \leq T \leq 100\text{ }^{\circ}\text{C}$ |            | $TC_{\lambda_{dom.}}$ |      | 0.06     |      | nm/K  |

**OPTICAL AND ELECTRICAL CHARACTERISTICS** ( $T_{amb} = 25\text{ }^{\circ}\text{C}$ , unless otherwise specified)  
**VLMK51..., AMBER**

| PARAMETER                                | TEST CONDITION   | PART       | SYMBOL                | MIN. | TYP.     | MAX. | UNIT  |
|--|--|------------|-----------------------|------|----------|------|-------|
| Luminous intensity                       | $I_F = 140\text{ mA}$  | VLMK51Y1Z1 | $I_V$                 | 2850 | 4500     | 5600 | mcd   |
| Luminous flux                            | $I_F = 140\text{ mA}$  | VLMK51Y1Z1 | $\Phi_V$              |      | 11.9     |      | lm    |
| Dominant wavelength                      | $I_F = 140\text{ mA}$  |            | $\lambda_{dom}$       | 610  |          | 621  | nm    |
| Angle of half intensity                  | $I_F = 140\text{ mA}$  |            | $\varphi$             |      | $\pm 60$ |      | deg   |
| Forward voltage                          | $I_F = 140\text{ mA}$  |            | $V_F$                 | 1.9  | 2.2      | 2.65 | V     |
| Temperature coefficient $I_V$            | $I_F = 140\text{ mA}$ ,<br>$0\text{ }^{\circ}\text{C} \leq T \leq 100\text{ }^{\circ}\text{C}$ |            | $TC_{I_V}$            |      | - 35.3   |      | mcd/K |
| Temperature coefficient $V_F$            | $I_F = 140\text{ mA}$ ,<br>$0\text{ }^{\circ}\text{C} \leq T \leq 100\text{ }^{\circ}\text{C}$ |            | $TC_{V_F}$            |      | - 2.9    |      | mV/K  |
| Temperature coefficient $\lambda_{dom.}$ | $I_F = 140\text{ mA}$ ,<br>$0\text{ }^{\circ}\text{C} \leq T \leq 100\text{ }^{\circ}\text{C}$ |            | $TC_{\lambda_{dom.}}$ |      | 0.07     |      | nm/K  |

| <b>OPTICAL AND ELECTRICAL CHARACTERISTICS</b> ( $T_{amb} = 25\text{ }^{\circ}\text{C}$ , unless otherwise specified)<br><b>VLMY51..., YELLOW</b> |  |            |                      |      |          |      |       |
|--|--|------------|----------------------|------|----------|------|-------|
| PARAMETER  | TEST CONDITION   | PART       | SYMBOL               | MIN. | TYP.     | MAX. | UNIT  |
| Luminous intensity   | $I_F = 140\text{ mA}$  | VLMY51Y2Z2 | $I_V$                | 3550 | 5000     | 7150 | mcd   |
| Luminous flux  | $I_F = 140\text{ mA}$  | VLMY51Y2Z2 | $\Phi_V$             |      | 13.2     |      | lm    |
| Dominant wavelength  | $I_F = 140\text{ mA}$  |            | $\lambda_{dom}$      | 585  |          | 594  | nm    |
| Angle of half intensity  | $I_F = 140\text{ mA}$  |            | $\phi$               |      | $\pm 60$ |      | deg   |
| Forward voltage  | $I_F = 140\text{ mA}$  |            | $V_F$                | 1.9  | 2.2      | 2.65 | V     |
| Temperature coefficient $I_V$  | $I_F = 140\text{ mA}$ ,<br>$0\text{ }^{\circ}\text{C} \leq T \leq 100\text{ }^{\circ}\text{C}$ |            | $TC_{I_V}$           |      | -55.5    |      | mcd/K |
| Temperature coefficient $V_F$  | $I_F = 140\text{ mA}$ ,<br>$0\text{ }^{\circ}\text{C} \leq T \leq 100\text{ }^{\circ}\text{C}$ |            | $TC_V$               |      | -2.9     |      | mV/K  |
| Temperature coefficient $\lambda_{dom}$  | $I_F = 140\text{ mA}$ ,<br>$0\text{ }^{\circ}\text{C} \leq T \leq 100\text{ }^{\circ}\text{C}$ |            | $TC_{\lambda_{dom}}$ |      | 0.09     |      | nm/K  |

| <b>LUMINOUS INTENSITY CLASSIFICATION</b> |                          |      |
|--|--------------------------|------|
| GROUP                                    | LUMINOUS INTENSITY (mcd) |      |
|  | MIN.                     | MAX. |
| Y1                                       | 2850                     | 3550 |
| Y2                                       | 3550                     | 4500 |
| Z1                                       | 4500                     | 5600 |
| Z2                                       | 5600                     | 7150 |

Note:

Luminous flux is tested at a current pulse duration of 25 ms and an accuracy of  $\pm 11\%$ .

The above type numbers represent the order groups which include only a few brightness groups. Only one group will be shipped on each reel (there will be no mixing of two groups on each reel).

In order to ensure availability, single brightness groups will not be orderable.

In a similar manner for colors where wavelength groups are measured and binned, single wavelength groups will be shipped on any one reel. In order to ensure availability, single wavelength groups will not be orderable.

| <b>COLOR CLASSIFICATION</b> |                      |      |        |      |
|-----------------------------|----------------------|------|--------|------|
| GROUP                       | AMBER                |      | YELLOW |      |
|                             | DOM. WAVELENGTH (nm) |      |        |      |
|                             | MIN.                 | MAX. | MIN.   | MAX. |
| W                           | 610                  | 615  |        |      |
| X                           | 615                  | 621  | 585    | 588  |
| Y                           |                      |      | 588    | 591  |
| Z                           |                      |      | 591    | 594  |

Note:

Wavelengths are tested at a current pulse duration of 25 ms and an accuracy of  $\pm 1\text{ nm}$ .

**TYPICAL CHARACTERISTICS** ( $T_{amb} = 25\text{ }^{\circ}\text{C}$ , unless otherwise specified)

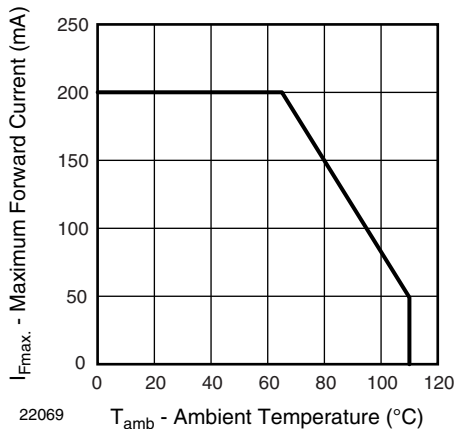

Figure 1. Forward Current vs. Ambient Temperature

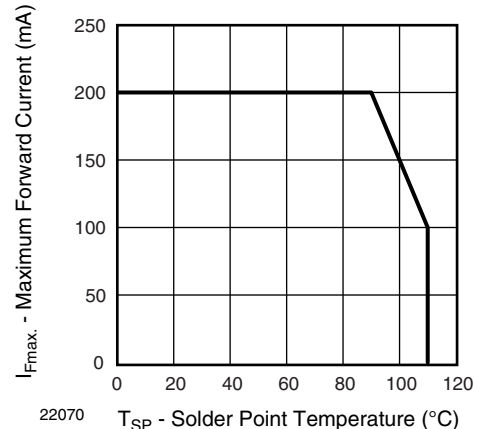

Figure 2. Max. Forward Current vs. Solder Point Temperature

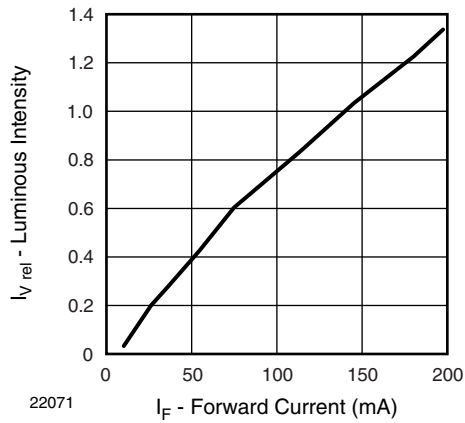

Figure 3. Rel. Luminous Intensity vs. Forward Current

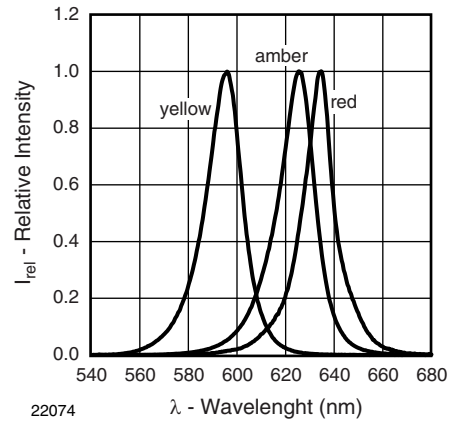

Figure 6. Relative Intensity vs. Wavelength

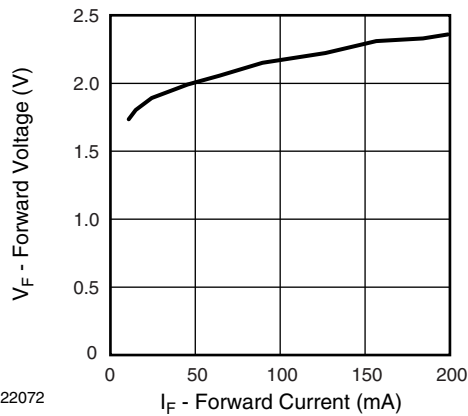

Figure 4. Rel. Forward Voltage vs. Forward Current

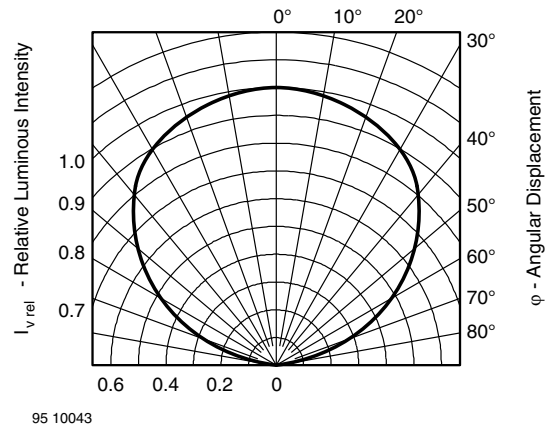

Figure 7. Rel. Luminous Intensity vs. Angular Displacement

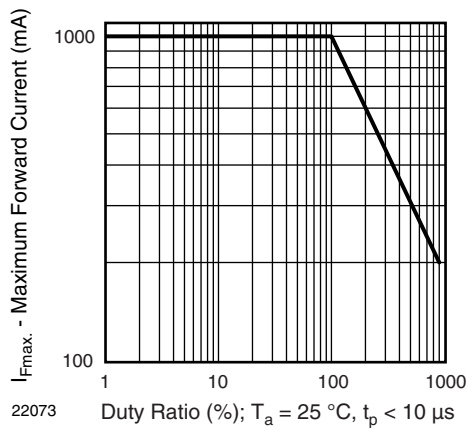
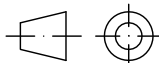
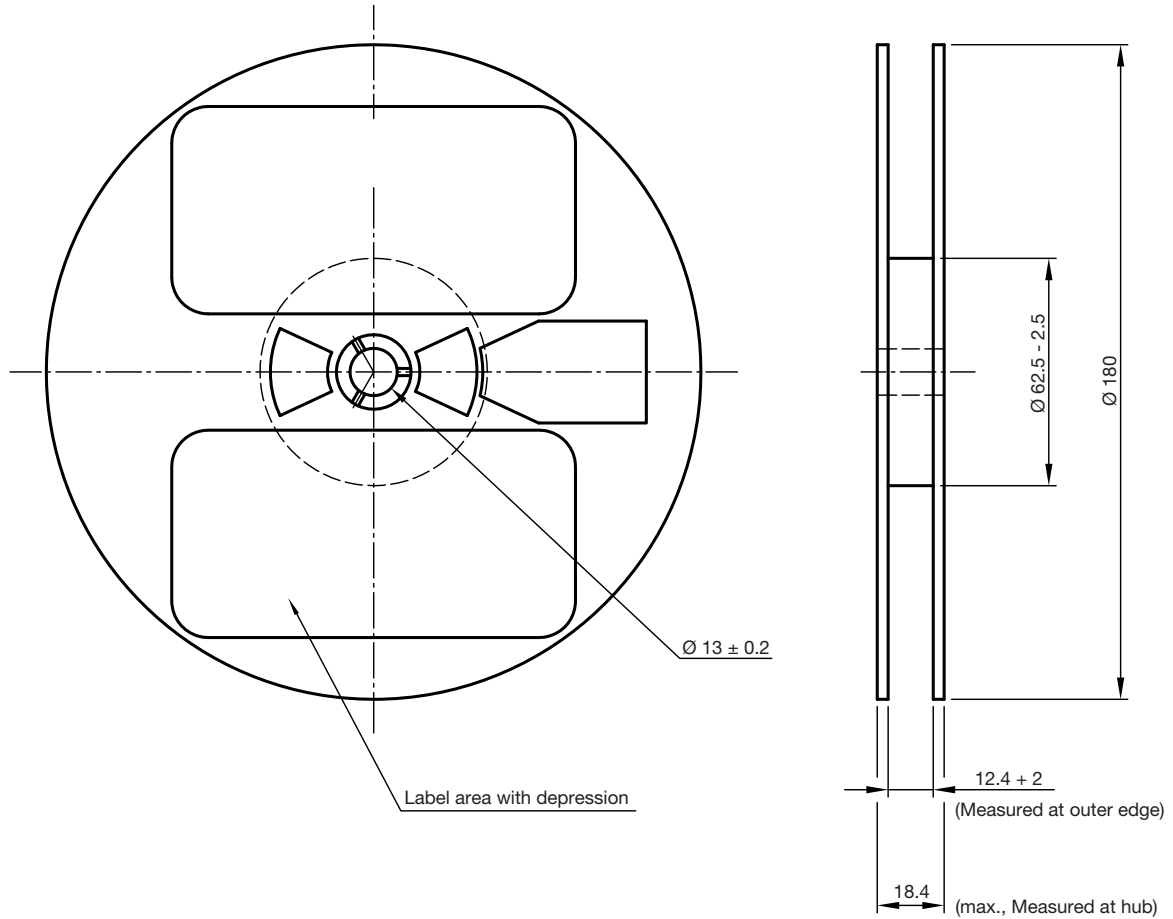

Figure 5. Forward Current vs. Duty Ratio

**REEL DIMENSIONS** in millimeters



technical drawings  
 according to DIN  
 specifications

Not indicated tolerances  $\pm 0.5$

Material: black static dissipative

GS08 = 1000 pcs

Drawing-No.: 9.800-5104.01-4

Issue: 2; 19.03.10

22067

## TAPING AND ORIENTATION DIMENSIONS in millimeters

Reels come in quantity of 1000 units.

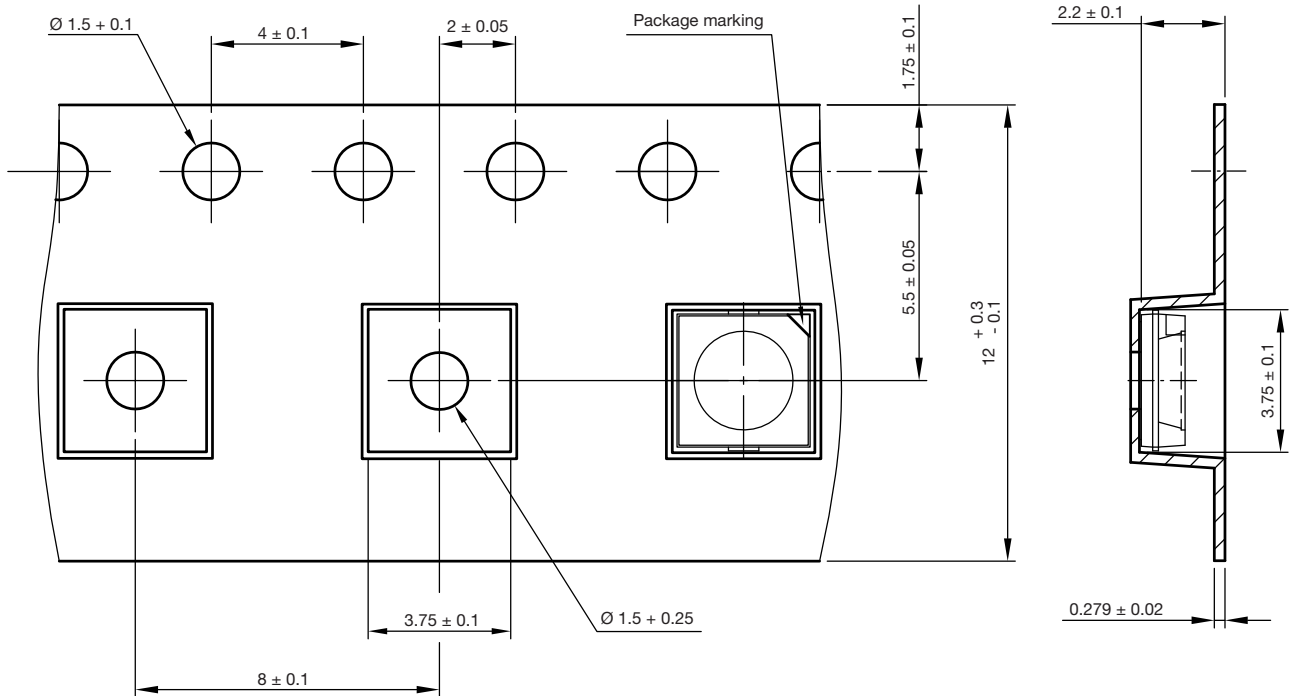

200 mm min. for Ø 180 reel

480 mm min. for Ø 180 reel

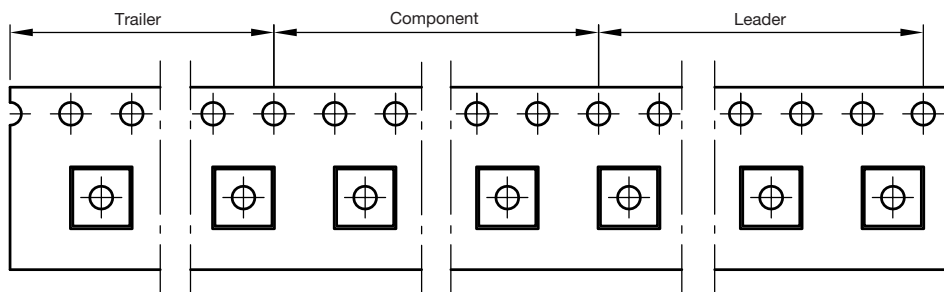

User feed direction →

Drawing-No.: 9.700-5348.01-4

Issue: 1; 01.03.10

22066

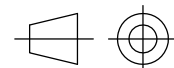

technical drawings  
according to DIN  
specifications

## RECOMMENDED PAD DESIGN DIMENSIONS in millimeters

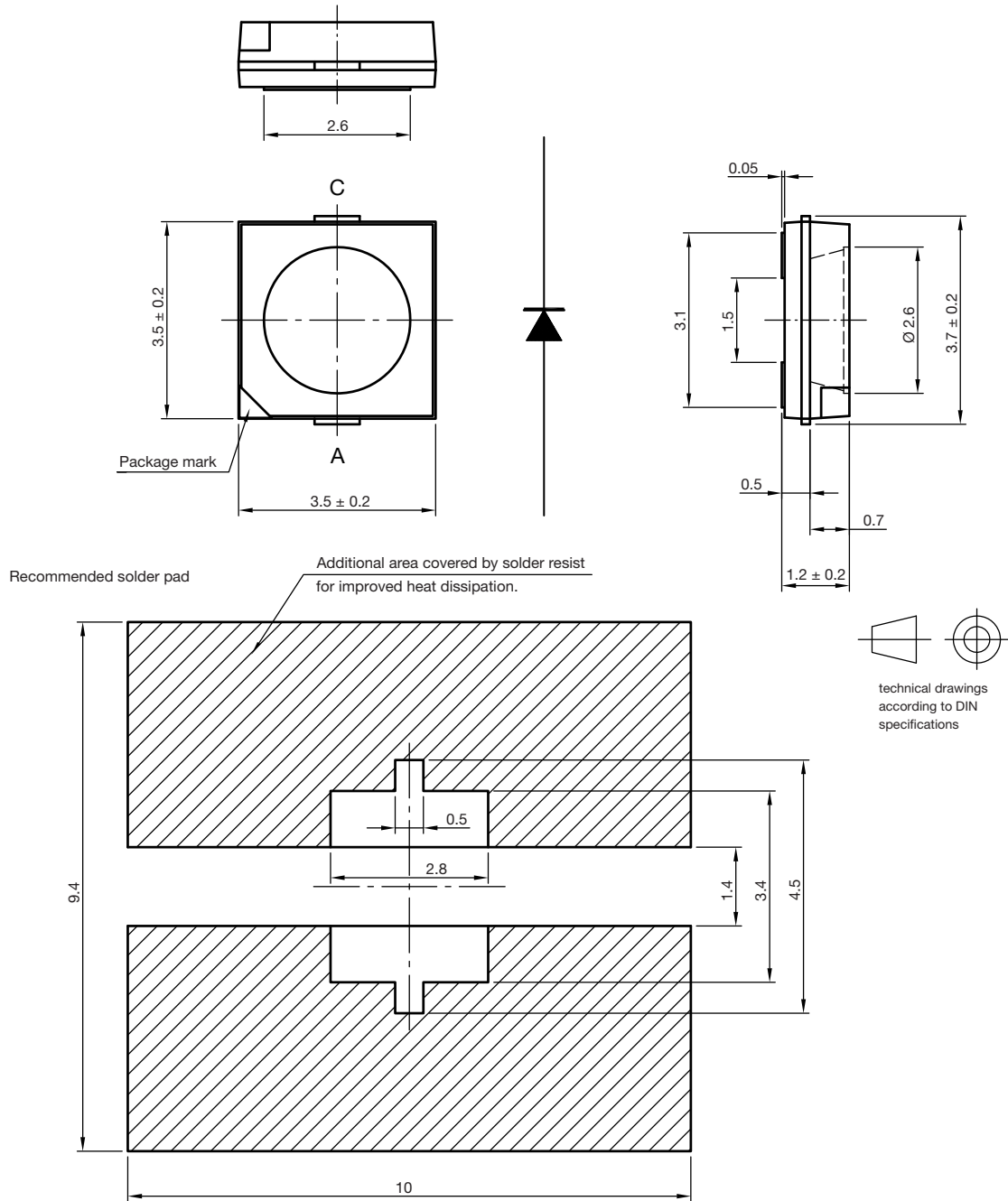

Drawing-No.: 6.541-5084.01-4  
 Issue: 1 ; 13.04.10  
 22103

### SOLDERING PROFILE

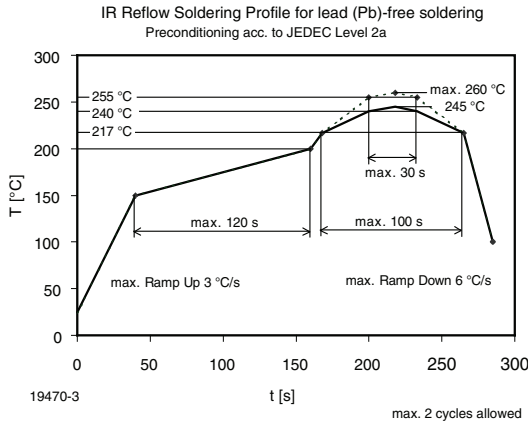
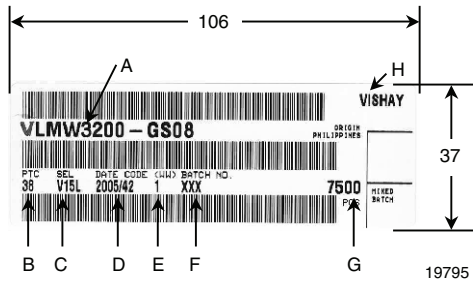

Figure 8. Vishay Lead (Pb)-free Reflow Soldering Profile (acc. to J-STD-020)

### BARCODE-PRODUCT-LABEL EXAMPLE:



- A) Type of component
- B) Manufacturing plant
- C) SEL - selection code (bin):  
e.g.: V1 = code for luminous intensity group  
5L = code for chrom. coordinate group
- D) Date code year/week
- E) Day code (e. g. 1: Monday)
- F) Batch no.
- G) Total quantity
- H) Company code

### DRY PACKING

The reel is packed in an anti-humidity bag to protect the devices from absorbing moisture during transportation and storage.

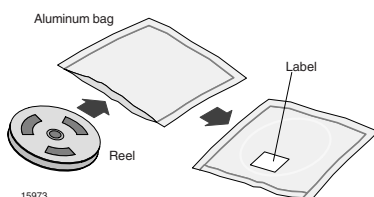

### FINAL PACKING

The sealed reel is packed into a cardboard box. A secondary cardboard box is used for shipping purposes.

### RECOMMENDED METHOD OF STORAGE

Dry box storage is recommended as soon as the aluminum bag has been opened to prevent moisture absorption. The following conditions should be observed, if dry boxes are not available:

- Storage temperature 10 °C to 30 °C
- Storage humidity ≤ 60 % RH max.

After more than 672 h under these conditions moisture content will be too high for reflow soldering.

In case of moisture absorption, the devices will recover to the former condition by drying under the following condition:

192 h at 40 °C + 5 °C/- 0 °C and < 5 % RH (dry air/nitrogen) or

96 h at 60 °C + 5 °C and < 5 % RH for all device containers or

24 h at 100 °C + 5 °C not suitable for reel or tubes.

An EIA JEDEC standard JESD22-A112 level 2a label is included on all dry bags.

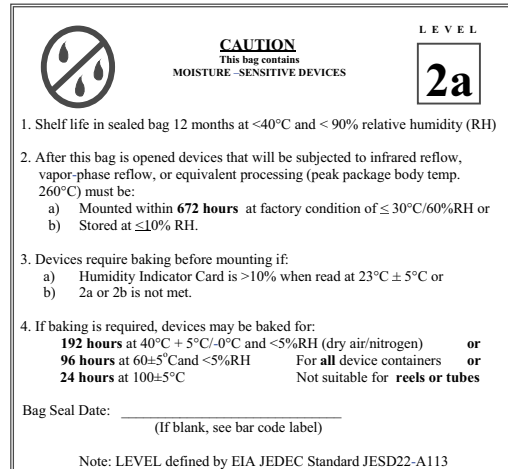

Example of JESD22-A112 Level 2a label

### ESD PRECAUTION

Proper storage and handling procedures should be followed to prevent ESD damage to the devices especially when they are removed from the antistatic shielding bag. Electro-static sensitive devices warning labels are on the packaging.





## Disclaimer

All product specifications and data are subject to change without notice.

Vishay Intertechnology, Inc., its affiliates, agents, and employees, and all persons acting on its or their behalf (collectively, "Vishay"), disclaim any and all liability for any errors, inaccuracies or incompleteness contained herein or in any other disclosure relating to any product.

Vishay disclaims any and all liability arising out of the use or application of any product described herein or of any information provided herein to the maximum extent permitted by law. The product specifications do not expand or otherwise modify Vishay's terms and conditions of purchase, including but not limited to the warranty expressed therein, which apply to these products.

No license, express or implied, by estoppel or otherwise, to any intellectual property rights is granted by this document or by any conduct of Vishay.

The products shown herein are not designed for use in medical, life-saving, or life-sustaining applications unless otherwise expressly indicated. Customers using or selling Vishay products not expressly indicated for use in such applications do so entirely at their own risk and agree to fully indemnify Vishay for any damages arising or resulting from such use or sale. Please contact authorized Vishay personnel to obtain written terms and conditions regarding products designed for such applications.

Product names and markings noted herein may be trademarks of their respective owners.