

Features

Plug-in

12 A Power relay, 2 & 4 pole

- Flange mount option - (Faston 187, 4.8x0.5 mm termination)
- AC coils & DC coils
- Lockable test button and mechanical flag indicator - standard on 2 pole types
- Cadmium Free contacts (preferred version)
- Contact material options
- 96 series sockets, coil EMC suppression, accessories

* For 4 CO (4PDT) only.

56.32



- 2 pole changeover contact
- Plug-in/Faston 187

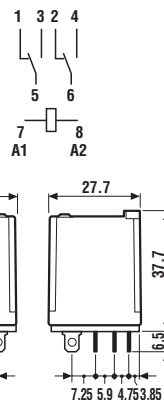

56.32-0300



- 2 pole normally open contact (1.5 mm gap)
- Plug-in/Faston 187

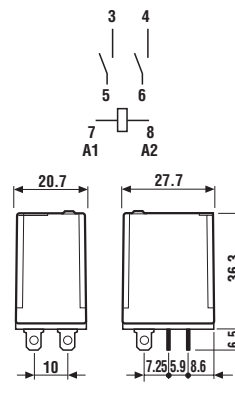

56.34



- 4 pole changeover contact
- Plug-in/Faston 187

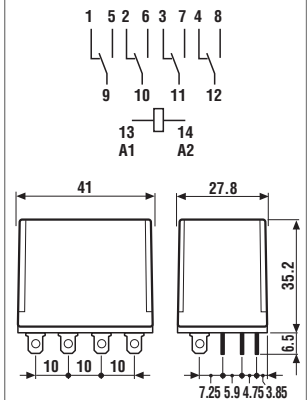

56

Contact specification		56.32	56.32-0300	56.34
Contact configuration		2 CO (DPDT)	2 NO (DPST-NO) - 1.5 mm	4 CO (4PDT)
Rated current/Maximum peak current	A	12/20	12/20	12/20
Rated voltage/Maximum switching voltage V AC		250/400	250/400	250/400
Rated load AC1	VA	3,000	3,000	3,000
Rated load AC15 (230 V AC)	VA	500	500	500
Single phase motor rating (230 V AC)	kW	0.55	0.55	0.55
Breaking capacity DC1: 30/110/220 V	A	12/0.25/0.12	12/0.6/0.3	12/0.25/0.12
Minimum switching load	mW (V/mA)	500 (10/5)	500 (10/5)	500 (10/5)
Standard contact material		AgNi	AgNi	AgNi
Coil specification		56.32	56.32-0300	56.34
Nominal voltage (U _N)	V AC (50/60 Hz)	6 - 12 - 24 - 48 - 60 - 110 - 120 - 230 - 240 - 400*		
	V DC	6-12-24-48-60-110-125-220	—	6-12-24-48-60-110-125-220
Rated power AC/DC	VA (50 Hz)/W	1.5/1	1.5/—	2/1.3
Operating range	AC	(0.8...1.1)U _N	(0.85...1.1)U _N	(0.8...1.1)U _N
	DC	(0.8...1.1)U _N	—	(0.85...1.1)U _N
Holding voltage	AC/DC	0.8 U _N /0.6 U _N	0.85 U _N /—	0.8 U _N /0.6 U _N
Must drop-out voltage	AC/DC	0.2 U _N /0.1 U _N	0.2 U _N /—	0.2 U _N /0.1 U _N
Technical data		56.32	56.32-0300	56.34
Mechanical life AC/DC	cycles	20 · 10 ⁶ /50 · 10 ⁶	20 · 10 ⁶ /—	20 · 10 ⁶ /50 · 10 ⁶
Electrical life at rated load AC1	cycles	200 · 10 ³	200 · 10 ³	150 · 10 ³
Operate/release time	ms	8/8	8/4	8/8
Insulation between coil and contacts (1.2/50 μs)	kV	4	4	5
Dielectric strength between open contacts	V AC	1,000	2,000	1,000
Ambient temperature range	°C	-40...+70	-40...+70	-40...+70
Environmental protection		RT I	RT I	RT I
Approvals (according to type)				

Features

Printed circuit mount 12 A Power relay

- 2 & 4 pole
- AC coils & DC coils
- Cadmium Free contacts (preferred version)
- Contact material option

56

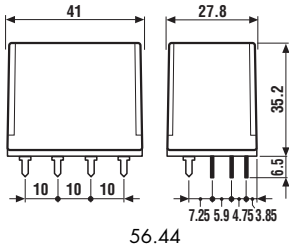
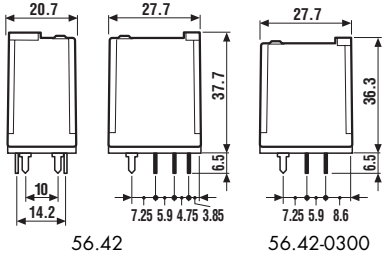

* For 4 CO (4PDT) only

56.42



- 2 pole changeover contact
- PCB mount

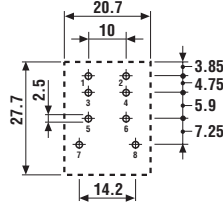
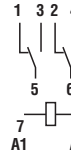

Copper side view

56.42-0300



- 2 pole normally open contact (1.5 mm gap)
- PCB mount

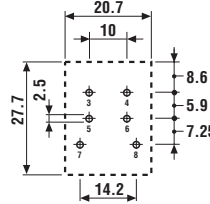
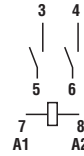

Copper side view

56.44



- 4 pole changeover contact
- PCB mount

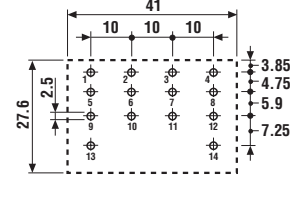
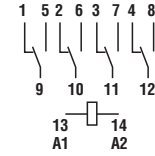

Copper side view

Contact specification		56.42	56.42-0300	56.44						
Contact configuration		2 CO (DPDT)	2 NO (DPST-NO) 1.5 mm	4 CO (4PDT)						
Rated current/Maximum peak current	A	12/20	12/20	12/20						
Rated voltage/Maximum switching voltage	V AC	250/400	250/400	250/400						
Rated load AC1	VA	3,000	3,000	3,000						
Rated load AC15 (230 V AC)	VA	500	500	500						
Single phase motor rating (230 V AC)	kW	0.55	0.55	0.55						
Breaking capacity DC1: 30/110/220 V	A	12/0.25/0.12	12/0.6/0.3	12/0.25/0.12						
Minimum switching load	mW (V/mA)	500 (10/5)	500 (10/5)	500 (10/5)						
Standard contact material		AgNi	AgNi	AgNi						
Coil specification		56.42	56.42-0300	56.44						
Nominal voltage (U _N)	V AC (50/60 Hz)	6 - 12 - 24 - 48 - 60 - 110 - 120 - 230 - 240 - 400*								
	V DC	6-12-24-48-60-110-125-220	—	6-12-24-48-60-110-125-220						
Rated power AC/DC	VA (50 Hz)/W	1.5/1	1.5/—	2/1.3						
Operating range	AC	(0.8...1.1)U _N	(0.85...1.1)U _N	(0.8...1.1)U _N						
	DC	(0.8...1.1)U _N	—	(0.85...1.1)U _N						
Holding voltage	AC/DC	0.8 U _N /0.6 U _N	0.85 U _N /—	0.8 U _N /0.6 U _N						
Must drop-out voltage	AC/DC	0.2 U _N /0.1 U _N	0.2 U _N /—	0.2 U _N /0.1 U _N						
Technical data		56.42	56.42-0300	56.44						
Mechanical life AC/DC	cycles	20 · 10 ⁶ /50 · 10 ⁶	20 · 10 ⁶ /—	20 · 10 ⁶ /50 · 10 ⁶						
Electrical life at rated load AC1	cycles	200 · 10 ³	200 · 10 ³	150 · 10 ³						
Operate/release time	ms	8/8	8/4	8/8						
Insulation between coil and contacts (1.2/50 μs)	kV	4	4	5						
Dielectric strength between open contacts	V AC	1,000	2,000	1,000						
Ambient temperature range	°C	-40...+70	-40...+70	-40...+70						
Environmental protection		RT I	RT I	RT I						
Approvals (according to type)		CE	B	SE	PG	NY	IRAM	NF	CULUS	VDE

Ordering information

Example: 56 series plug-in relay, 2 CO (DPDT), 12 V DC coil, lockable test button and mechanical indicator.

5 6 . 3 2 . 9 . 0 1 2 . 0 0 4 0

Series ——— 5 6

Type ——— 3
3 = Plug-in
4 = PCB

No. of poles ——— 2 . 9
2 = 2 pole, 12 A
4 = 4 pole, 12 A

Coil version ——— 0 1 2
8 = AC (50/60 Hz)
9 = DC

Coil voltage ——— 0 0 4 0
see coil specifications

A: Contact material
0 = Standard AgNi
2 = AgCdO
4 = AgSnO₂

B: Contact circuit
0 = CO (nPDT)
3 = NO (nPST),
1.5 mm contact gap

D: Special versions
0 = Standard
5 = Top flange mount (56.34 only)
6 = Rear flange mount
7 = Top 35 mm rail mount (56.34 only)
8 = Rear 35 mm rail mount (56.34 only)

C: Options
0 = None
1 = Test button
2 = Mechanical indicator
3 = LED (AC)
4 = Lockable test button+mechanical indicator
5 = Lockable test button + LED (AC)
54 = Lockable test button + LED (AC) +
mechanical indicator
6 = Double LED (DC non-polarized)
7 = Lockable test button + double LED
(DC non-polarized)
74 = Lockable test button + double LED
(DC non-polarized) +
mechanical indicator
8 = LED + diode (DC, polarity positive to pin 7)
9 = Lockable test button + LED + diode
(DC, polarity positive to pin 7)
94 = Lockable test button + LED + diode
(DC, polarity positive to pin 7) +
mechanical indicator

56

Selecting features and options: only combinations in the same row are possible.
Preferred selections for best availability are shown in **bold**.

Type	Coil version	A	B	C	D
56.32	AC	0 - 2 - 4	0	0 - 2 - 3 - 4 - 5	0 - 6
	AC	0 - 2 - 4	0	54	/
	AC	0 - 2 - 4	3	0 - 3 - 5	0 - 6
	DC	0 - 2 - 4	0	0 - 2 - 4 - 8 - 9	0 - 6
	DC	0 - 2 - 4	0	94	/
56.34	AC-DC	0 - 2 - 4	0	0 - 1	0 - 5 - 6 - 7 - 8
56.42	AC	0 - 2 - 4	0 - 3	0	0
56.44	AC-DC	0 - 2 - 4	0	0	0

Descriptions: Options and Special versions

C: Option 3, 5, 54 LED (AC)	C: Option 6, 7, 74 Double LED (DC non-polarized)	C: Option 8, 9, 94 LED + diode (DC, polarity positive to pin 7)	D: Special versions 6 Rear flange mount (56.34 only)	D: Special versions 8 Rear 35 mm rail mount (56.34 only)



Lockable test button and mechanical flag indicator (0040)

The dual-purpose Finder test button can be used in two ways:

Case 1) The plastic pip (located directly above the test button) remains intact. In this case, when the test button is pushed, the contacts operate. When the test button is released the contacts return to their former state.

Case 2) The plastic pip is broken-off (using an appropriate cutting tool). In this case, (in addition to the above function), when the test button is pushed and rotated, the contacts are latched in the operating state, and remain so until the test button is rotated back to its former position.

In both cases ensure that the test button actuation is swift and decisive.

Technical data

Insulation					
Insulation according to EN 61810-1 ed. 2	insulation rated voltage	V	250	400	
	rated impulse withstand voltage	kV	4	4	
	pollution degree		3	2	
	overvoltage category		III	III	
Insulation between coil and contacts (1.2/50 μs)		kV	4 (2 contacts); 5 (4 contacts)		
Dielectric strength between open contacts		V AC	1,000 (changeover); 2,000 (normally open)		
Dielectric strength between adjacent contacts		V AC	2,500		
Conducted disturbance immunity					
Burst (5...50)ns, 5 kHz, on A1 - A2		EN 61000-4-4	level 4 (4 kV)		
Surge (1.2/50 μs) on A1 - A2 (differential mode)		EN 61000-4-5	level 4 (4 kV)		
Other data					
Bounce time: NO/NC		ms	1/3 (changeover)	3/— (normally open)	
Vibration resistance (5...55)Hz, max. ± 1 mm: NO/NC		g/g	15/15		
Shock resistance		g	16		
Power lost in the environment			2 pole	4 pole	
		without contact current	W	1	1.3
		with rated current	W	3.8	6.9
Recommended distance between relays mounted on PCB		mm	≥ 5		

56

Contact specification

F 56 - Electrical life (AC) v contact current
2 pole relays

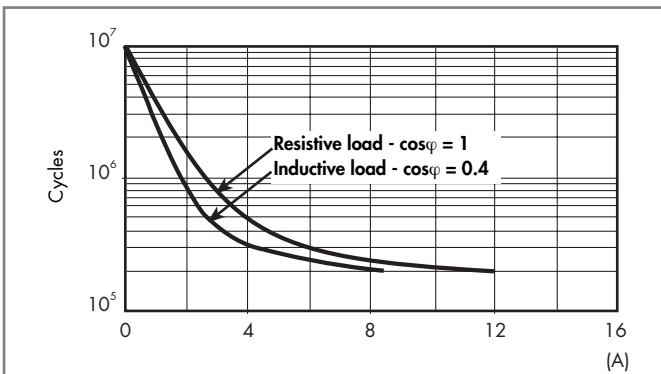

F 56 - Electrical life (AC) v contact current
4 pole relays

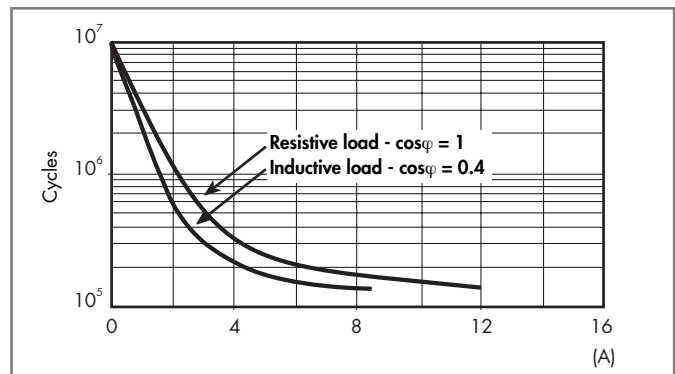

H 56 - Maximum DC1 breaking capacity
Changeover version

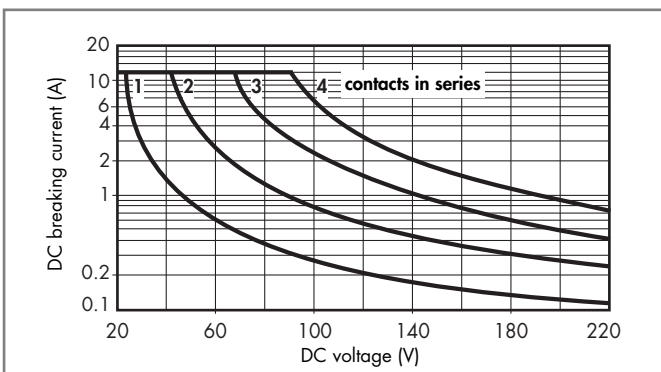

H 56 - Maximum DC1 breaking capacity
Normally open version

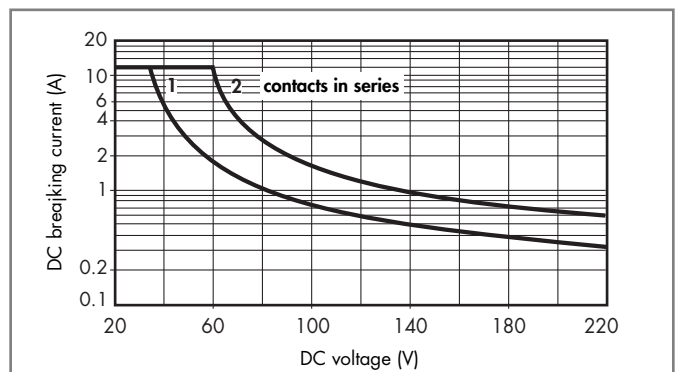

- When switching a resistive load (DC1) having voltage and current values under the curve, an electrical life of $\geq 100 \cdot 10^3$ can be expected.
 - In the case of DC13 loads, the connection of a diode in parallel with the load will permit a similar electrical life as for a DC1 load.
- Note: the release time of the load will increased.

Coil specifications

DC coil data, 2 pole relay

Nominal voltage U_N	Coil code	Operating range		Resistance R	Rated coil consumption I at U_N
		U_{min}	U_{max}		
V		V	V	Ω	mA
6	9.006	4.8	6.6	40	150
12	9.012	9.6	13.2	140	86
24	9.024	19.2	26.4	600	40
48	9.048	38.4	52.8	2,400	20
60	9.060	48	66	4,000	15
110	9.110	88	121	12,500	8.8
125	9.125	100	137.5	17,300	7.2
220	9.220	176	242	54,000	4

AC coil data, 2 pole relay

Nominal voltage U_N	Coil code	Operating range		Resistance R	Rated coil consumption I at U_N [50Hz]
		U_{min}^*	U_{max}		
V		V	V	Ω	mA
6	8.006	4.8	6.6	12	200
12	8.012	9.6	13.2	50	97
24	8.024	19.2	26.4	190	53
48	8.048	38.4	52.8	770	25
60	8.060	48	66	1,200	21
110	8.110	88	121	3,940	12.5
120	8.120	96	132	4,700	12
230	8.230	184	253	17,000	6
240	8.240	192	264	19,100	5.3

* $U_{min} = 0.85 U_N$ for normally open version.

DC coil data, 4 pole relay

Nominal voltage U_N	Coil code	Operating range		Resistance R	Rated coil consumption I at U_N
		U_{min}	U_{max}		
V		V	V	Ω	mA
6	9.006	5.1	6.6	32.5	185
12	9.012	10.2	13.2	123	97
24	9.024	20.4	26.4	490	49
48	9.048	40.8	52.8	1,800	27
60	9.060	51	66	3,000	20
110	9.110	93.5	121	10,400	10.5
125	9.125	107	137.5	14,200	8.8
220	9.220	187	242	44,000	5

AC coil data, 4 pole relay

Nominal voltage U_N	Coil code	Operating range		Resistance R	Rated coil consumption I at U_N [50Hz]
		U_{min}	U_{max}		
V		V	V	Ω	mA
6	8.006	4.8	6.6	5.7	300
12	8.012	9.6	13.2	22	150
24	8.024	19.2	26.4	81	90
48	8.048	38.4	52.8	380	37
60	8.060	48	66	600	30
110	8.110	88	121	1,900	16.5
120	8.120	96	132	2,560	13.4
230	8.230	184	253	7,700	9
240	8.240	192	264	10,000	7.5
400	8.400	320	440	26,000	4.9

56

R 56 - DC coil operating range v ambient temperature
2 pole relay

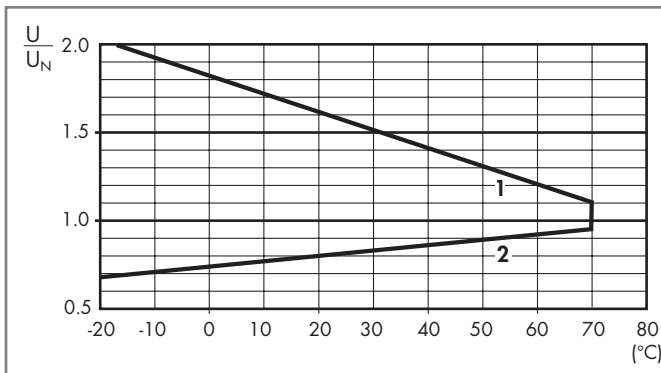

R 56 - AC coil operating range v ambient temperature
2 pole relay

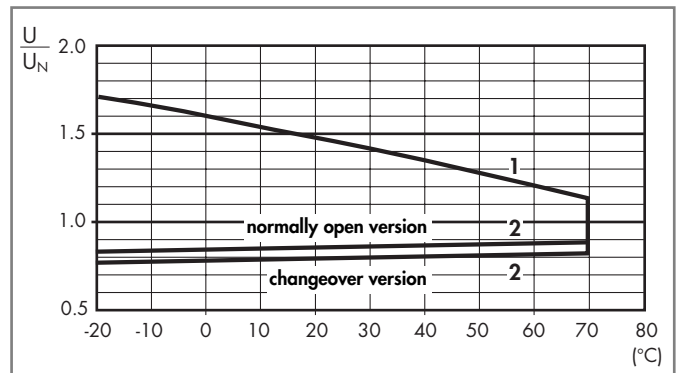

R 56 - DC coil operating range v ambient temperature
4 pole relay

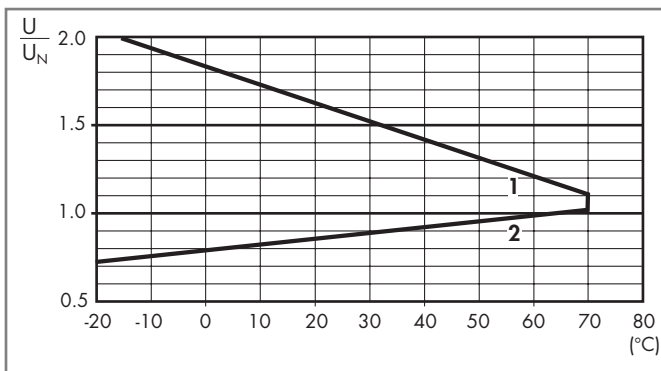

R 56 - AC coil operating range v ambient temperature
4 pole relay

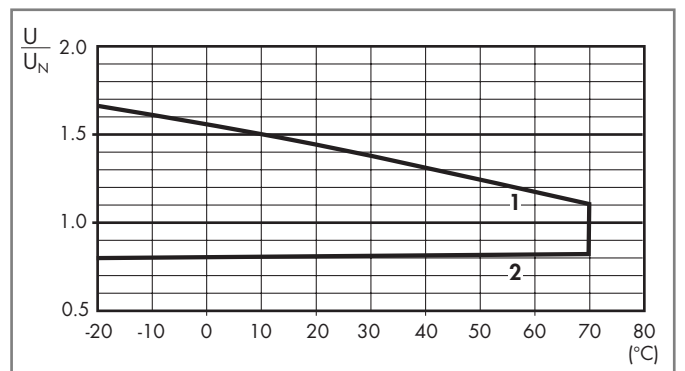

1 - Max. permitted coil voltage.
2 - Min. pick-up voltage with coil at ambient temperature.

1 - Max. permitted coil voltage.
2 - Min. pick-up voltage with coil at ambient temperature.

Accessories



Adaptor with top mount flange for 56.32.x.xxx.xx00

056.05

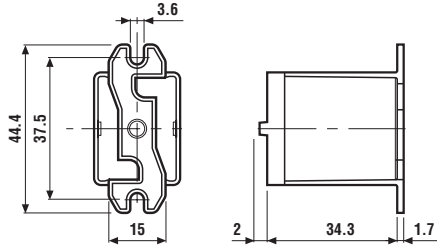



Approvals
(according to type):



Screw terminal (Plate clamp) socket panel or 35 mm rail (EN 50022) mount	96.72 (blue)	96.72.0 (black)	96.74 (blue)	96.74.0 (black)
For relay type	56.32		56.34	
Accessories				
Metal retaining clip (supplied with socket - packaging code SMA)	094.71		096.71	
Modules (see table below)	99.01			
Technical data				
Rated values	12 A - 250 V			
Dielectric strength	≥ 2 kV AC			
Protection category	IP 20			
Ambient temperature	°C -40...+70			
⊕ Screw torque	Nm	0.8		
Wire strip length	mm	10		
Max. wire size for 96.72 and 96.74 sockets		solid wire	stranded wire	
	mm ²	1x4 / 2x4		1x4 / 2x2.5
	AWG	1x12 / 2x12		1x12 / 2x14

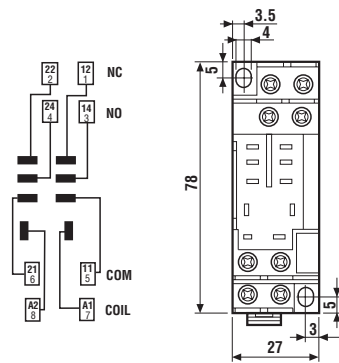

96.72

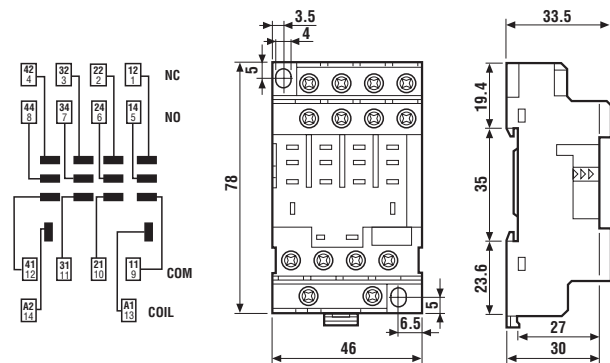

96.74

56



Approvals
(according to type):



99.01 coil indication and EMC suppression modules for types 96.72 and 96.74 sockets		
See technical data pages 247/248		Blue*
Diode (+A1, standard polarity)	(6...220)V DC	99.01.3.000.00
Diode (+A2, non-standard polarity)	(6...220)V DC	99.01.2.000.00
LED	(6...24)V DC/AC	99.01.0.024.59
LED	(28...60)V DC/AC	99.01.0.060.59
LED	(110...240)V DC/AC	99.01.0.230.59
LED + Diode (+A1, standard polarity)	(6...24)V DC	99.01.9.024.99
LED + Diode (+A1, standard polarity)	(28...60)V DC	99.01.9.060.99
LED + Diode (+A1, standard polarity)	(110...220)V DC	99.01.9.220.99
LED + Diode (+A2, non-standard polarity)	(6...24)V DC	99.01.9.024.79
LED + Diode (+A2, non-standard polarity)	(28...60)V DC	99.01.9.060.79
LED + Diode (+A2, non-standard polarity)	(110...220)V DC	99.01.9.220.79
LED + Varistor	(6...24)V DC/AC	99.01.0.024.98
LED + Varistor	(28...60)V DC/AC	99.01.0.060.98
LED + Varistor	(110...240)V DC/AC	99.01.0.230.98
RC circuit	(6...24)V DC/AC	99.01.0.024.09
RC circuit	(28...60)V DC/AC	99.01.0.060.09
RC circuit	(110...240)V DC/AC	99.01.0.230.09
Residual current by-pass (62 kΩ/1W)	(110...240)V AC	99.01.8.230.07

* Modules in Black housing are available on request.

Green LED is standard.
Red LED available on request.



Approvals
(according to type):



PCB socket	96.12 (blue)	96.12.0 (black)	96.14 (blue)	96.14.0 (black)
For relay type	56.32		56.34	
Accessories				
Metal retaining clip (supplied with socket - packaging code SMA)	094.51			
Technical data				
Rated values	15 A - 250 V			
Dielectric strength	≥ 2 kV AC			
Protection category	IP 20			
Ambient temperature	°C -40...+70			

56

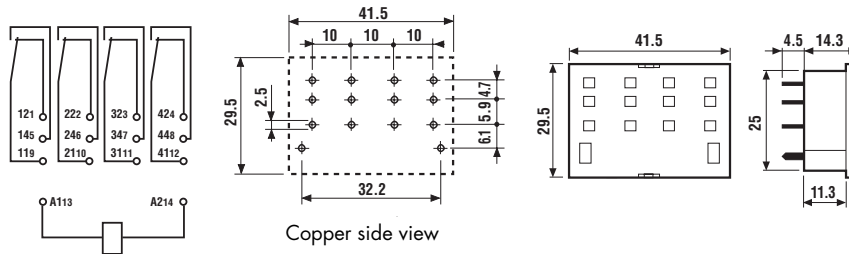
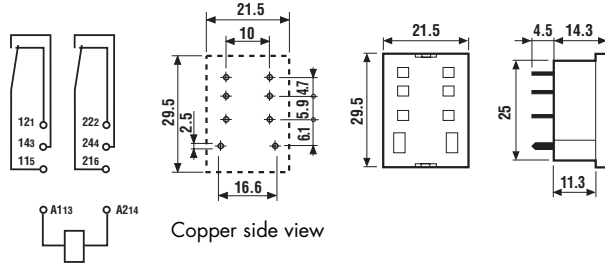

Packaging code

How to code and identify retaining clip and packaging options for sockets.

Code options according to the last three letters:



A Standard packaging

SM Metal retaining clip



Without retaining clip