

## Datasheet - Z4VH 336-11z



Position switch / 336 thermoplastic enclosure - DIN EN 50041 with Actuator / 336 Roller lever H



- Snap action with constant contact pressure up to switching point
- Lever angle adjustable in 10° steps
- thermoplastic enclosure
- Double-insulated
- Good resistance to oil and petroleum spirit
- 40,5 mm x 76 mm x 38 mm
- Wide range of alternative actuators
- Actuator heads can be repositioned by 4 x 90°
- 1 Cable entry M 20 x 1.5
- Design to EN 50041

(Minor differences between the printed image and the original product may exist!)

### Ordering details

Product type description	Z4VH 336-11Z
Article number	1151762
EAN code	4030661163611

### Approval

Approval	 USA/CAN  CCC
----------	--

### Classification

Standards	EN ISO 13849-1
B <sub>10d</sub> Normally-closed contact (NC)	20.000.000
Mission time notice	20 Years
	$MTTF_d = \frac{B_{10d}}{0,1 \times n_{op}}$ $n_{op} = \frac{d_{op} \times h_{op} \times 3600 \text{ s/h}}{t_{zyklus}}$

### Global Properties

Product name	336 Rollenschwenkhebel H
Standards	EN 60947-5-1 BG-GS-ET-15

Compliance with the Directives (Y/N) 	Yes
Suitable for safety functions (Y/N)	Yes
Actuator type	A to EN 50041
Materials	
- Material of the housings	Plastic, glass-fibre reinforced thermoplastic, self-extinguishing
- Lever material	Metal film
- Roller material	Plastic
- Material of the contacts	Silver
Housing coating	None
Housing construction form	Norm construction design
Weight	165 g

## Mechanical data

---

Design of actuating element	Roller lever
Design of electrical connection	Screw connection
Cable section	
- Min. Cable section	0,75 mm <sup>2</sup>
- Max. Cable section	2.5 mm <sup>2</sup>
Mechanical life	30.000.000 operations
Switching frequency	max. 5000 /h
actuating torque	min. 26 Ncm
Bounce duration	in accordance with actuating speed
Switchover time	< 2 ms
Actuating speed with actuating angle 30° to switch axis	
- Min. Actuating speed	
- Max. Actuating speed	2.5 m/s
notice	All indications about the cable section are including the conductor ferrules.

## Ambient conditions

---

Ambient temperature	
- Min. environmental temperature	- 30°C
- Max. environmental temperature	+ 80°C
Protection class	IP67

## Electrical data

---

Design of control element	Normally open contact (NO), Opener (NC)
Switching principle	Snap switch element
- positive break NC contact 	
Number of auxiliary contacts	1 piece
Number of safety contacts	1 piece
Rated impulse withstand voltage U <sub>imp</sub>	6 kV
Rated insulation voltage U <sub>i</sub>	500 V
Thermal test current I <sub>the</sub>	10 A
Utilisation category	AC-15: 230 V / 4 A, DC-13: 24 V / 1 A
Max. fuse rating	6 A gG D-fuse

## Dimensions

---

Dimensions of the sensor	
- Width of sensor	40.5 mm

- Height of sensor 129.5 mm
- Length of sensor 60.5 mm

### Diagram

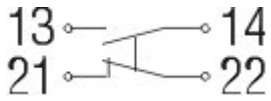

Note Diagram

- positive break NC contact
- active
- no active
- Normally-open contact
- Normally-closed contact

### Switch travel diagram

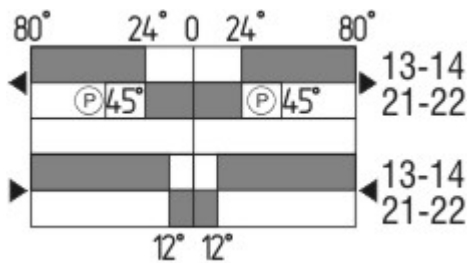

Notes Switch travel diagram

- Contact closed
- Contact open
- Setting range
- Break point
- Positive opening sequence/- angle
- VS** adjustable range of NO contact
- VÖ** adjustable range of NC contact
- N** after travel

### Ordering suffix

The applicable ordering suffix is added at the end of the part number of the safety switch.

Order example: Z4VH 336-11z-NPT

...-NPT

Cable entry NPT 1/2"

...-ST

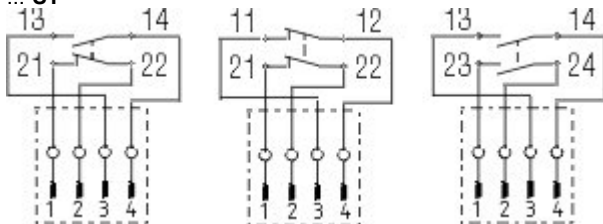

M12 connector with A-coding

...- 2310

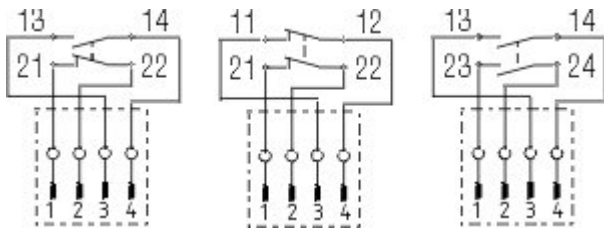

M12 connector with B-coding

...-1637

0,3 µm gold-plated contacts

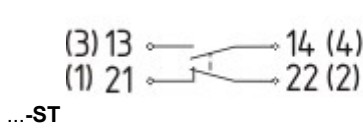

...-ST



M12 connector with A-coding

Rated impulse withstand voltage  $U_{imp}$ : 0,8 kV

Rated insulation voltage  $U_i$ : 50 V

Operating current  $I_e$ : AC-15: 50 V / 4 A

Caution! The versions with connector may only be used in PELV circuits to EN 60204-1.

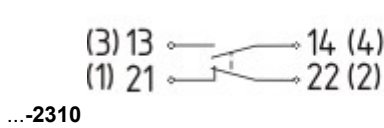

...-2310

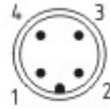

M12 connector with B-coding

Rated impulse withstand voltage  $U_{imp}$ : 0,8 kV

Rated insulation voltage  $U_i$ : 50 V

Operating current  $I_e$ : AC-15: 50 V / 4 A

Caution! The versions with connector may only be used in PELV circuits to EN 60204-1.

## Ordering code

(1)(2) 336-(3)Z(4)-(5)-(6)-(7)

(1)

**Z** Snap action

**T** Slow action

(2)

**S** Plunger S

**R** Roller plunger R

**H** Roller lever H

**10H** Rod lever 10H

**7H** Roller lever 7H

**1K** Offset roller lever 1K

**3K** Angle roller lever 3K

(3)

**11** 1 Normally open contact (NO) / 1 Opener (NC)

**02** 2 Opener (NC)

**20** 2 Normally open contact (NO), (Switch with 2 NO contacts are not for security tasks)

**01/01** 1 Opener (NC) left / 1 Opener (NC) right

(4)

**H** Slow action with staggered contacts

**UE** Slow action with overlapping contacts

(5)

*without* Cable entry M20

**NPT** cable entry NPT 1/2"

**ST** M12 connector with A-coding

**2310** M12 connector with B-coding

(6)

**2138** Roller lever 7H for Position switches with safety function

(7)

## Documents

---

**Operating instructions and Declaration of conformity** (pt) 586 kB, 01.03.2010  
[http://127.0.0.1/Bilddata/Si\\_f1/Pdf/Z332/bedien/PT/mrl\\_zt332-335-336-355\\_pt.pdf](http://127.0.0.1/Bilddata/Si_f1/Pdf/Z332/bedien/PT/mrl_zt332-335-336-355_pt.pdf)

**Operating instructions and Declaration of conformity** (nl) 710 kB, 01.12.2009  
[http://127.0.0.1/Bilddata/Si\\_f1/Pdf/Z332/bedien/NL/mrl\\_zt332-335-336-355\\_nl.pdf](http://127.0.0.1/Bilddata/Si_f1/Pdf/Z332/bedien/NL/mrl_zt332-335-336-355_nl.pdf)

**Operating instructions and Declaration of conformity** (cn) 797 kB, 02.03.2010  
[http://127.0.0.1/Bilddata/Si\\_f1/Pdf/Z332/bedien/CN/mrl\\_zt332-335-336-355\\_cn.pdf](http://127.0.0.1/Bilddata/Si_f1/Pdf/Z332/bedien/CN/mrl_zt332-335-336-355_cn.pdf)

**Operating instructions and Declaration of conformity** (de) 581 kB, 27.11.2009  
[http://127.0.0.1/Bilddata/Si\\_f1/Pdf/Z332/bedien/DE/mrl\\_zt332-335-336-355\\_de.pdf](http://127.0.0.1/Bilddata/Si_f1/Pdf/Z332/bedien/DE/mrl_zt332-335-336-355_de.pdf)

**Operating instructions and Declaration of conformity** (en) 605 kB, 22.03.2010  
[http://127.0.0.1/Bilddata/Si\\_f1/Pdf/Z332/bedien/EN/mrl\\_zt332-335-336-355\\_en.pdf](http://127.0.0.1/Bilddata/Si_f1/Pdf/Z332/bedien/EN/mrl_zt332-335-336-355_en.pdf)

**Operating instructions and Declaration of conformity** (es) 516 kB, 27.11.2009  
[http://127.0.0.1/Bilddata/Si\\_f1/Pdf/Z332/bedien/ES/mrl\\_zt332-335-336-355\\_es.pdf](http://127.0.0.1/Bilddata/Si_f1/Pdf/Z332/bedien/ES/mrl_zt332-335-336-355_es.pdf)

**Operating instructions and Declaration of conformity** (jp) 1 MB, 22.11.2010  
[http://127.0.0.1/Bilddata/Si\\_f1/Pdf/Z332/bedien/JP/mrl\\_zt332-335-336-355\\_jp.pdf](http://127.0.0.1/Bilddata/Si_f1/Pdf/Z332/bedien/JP/mrl_zt332-335-336-355_jp.pdf)

**Operating instructions and Declaration of conformity** (fr) 525 kB, 01.12.2009  
[http://127.0.0.1/Bilddata/Si\\_f1/Pdf/Z332/bedien/FR/mrl\\_zt332-335-336-355\\_fr.pdf](http://127.0.0.1/Bilddata/Si_f1/Pdf/Z332/bedien/FR/mrl_zt332-335-336-355_fr.pdf)

**Operating instructions and Declaration of conformity** (it) 513 kB, 01.12.2009  
[http://127.0.0.1/Bilddata/Si\\_f1/Pdf/Z332/bedien/IT/mrl\\_zt332-335-336-355\\_it.pdf](http://127.0.0.1/Bilddata/Si_f1/Pdf/Z332/bedien/IT/mrl_zt332-335-336-355_it.pdf)

**CCC certification** (cn) 605 kB, 12.12.2006  
[http://127.0.0.1/Bilddata/Si\\_f1/Pdf/Zt235/zertifikat/q\\_347p03.pdf](http://127.0.0.1/Bilddata/Si_f1/Pdf/Zt235/zertifikat/q_347p03.pdf)

**CCC certification** (en) 584 kB, 12.12.2006  
[http://127.0.0.1/Bilddata/Si\\_f1/Pdf/Zt235/zertifikat/q\\_347p02.pdf](http://127.0.0.1/Bilddata/Si_f1/Pdf/Zt235/zertifikat/q_347p02.pdf)

## Images

---

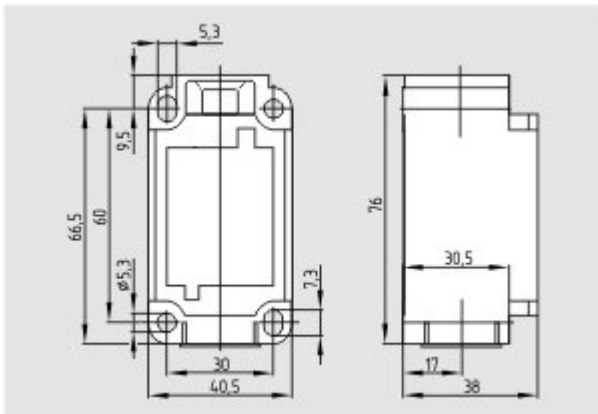

Dimensional drawing (basic component)

---

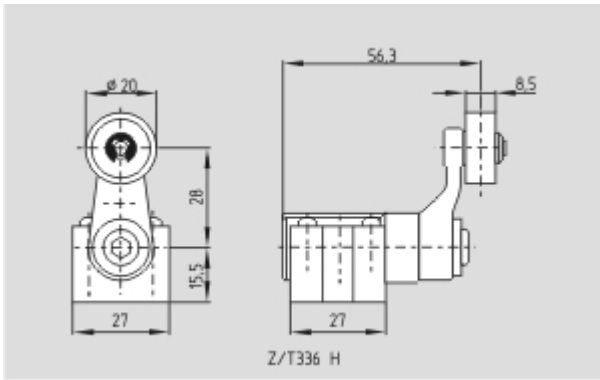

Dimensional drawing (actuator)

---

K.A. Schmersal GmbH, Möddinghofe 30, D-42279 Wuppertal  
The data and values have been checked thoroughly. Technical modifications and errors excepted.  
Generiert am 21.04.2011 - 16:52:13h Kasbase 1.4.7 DBI