

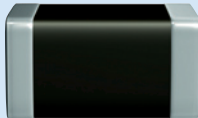

Sample Kit 2011

SMD PTC Thermistors

for Overcurrent Protection

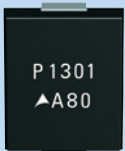
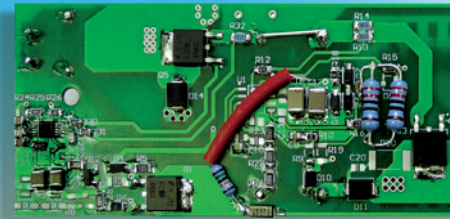
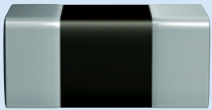

Features of SMD PTC thermistors

- Qualification based on AEC-Q200 rev. D for EIA case sizes 3225 and 4032
- Suitable for reflow (all types) and wave soldering (EIA case sizes 3225 and 4032 only)
- Lead-free tinned terminations
- RoHS-compatible
- Tolerance of $R_{F1} \pm 25\%$ (except B59907A*: $\pm 35\%$, B59085G* and B59080G*: $\pm 20\%$ and B59084G*: $\pm 15\%$)
- UL approval to UL 1434 with $V_{max} = 245 V$ for B5908*G1120****

Dimensional drawings in mm

EIA case size 0603

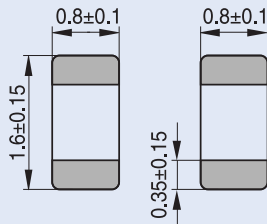

Termination

TPT0698-5-E

Solder pad

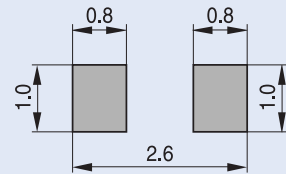

TPT0899-A

Recommended maximum dimensions

EIA case size 1210

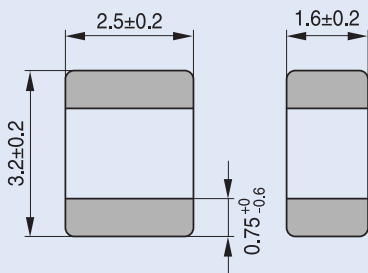

Termination

TPT0790-F-E

Solder pad

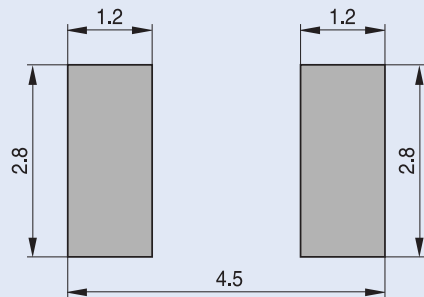

TPT0871-F

Recommended maximum dimensions

Components

A606 30 V, 90 mA	A607 30 V, 70 mA	A622 60 V, 22 mA	A623 80 V, 15 mA	A707 80 V, 50 mA	A807 265 V, 15 mA	A907 400 V, 12 mA		
---------------------	---------------------	---------------------	---------------------	---------------------	----------------------	----------------------	--	--

P1301 30 V, 205 mA	P1201 30 V, 165 mA	P1101 30 V, 90 mA	P1301 30 V, 310 mA	P1201 30 V, 265 mA	P1101 30 V, 170 mA			
-----------------------	-----------------------	----------------------	-----------------------	-----------------------	-----------------------	--	--	--



P1315 80 V, 80 mA	P1215 80 V, 65 mA	P1115 80 V, 40 mA	P1315 80 V, 150 mA	P1215 80 V, 100 mA	P1115 80 V, 70 mA	G1085 265 V, 180 mA	G1080 265 V, 130 mA	G1084 265 V, 90 mA
----------------------	----------------------	----------------------	-----------------------	-----------------------	----------------------	------------------------	------------------------	-----------------------

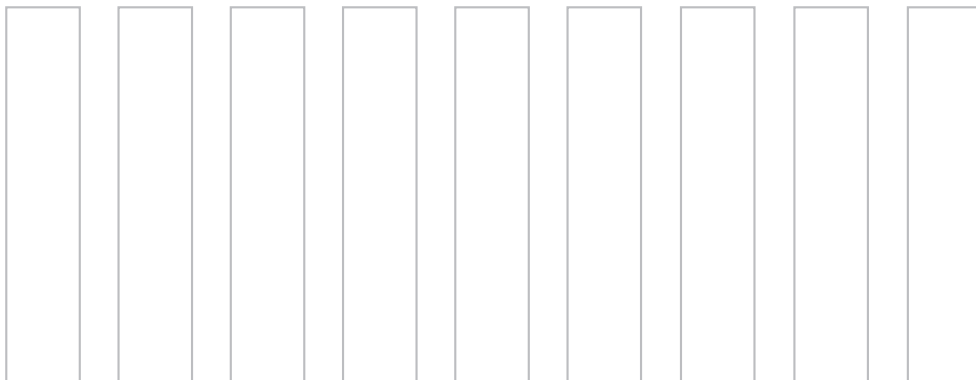

Product range

Electrical specifications and ordering codes							
EIA case size	Type	I_R [mA]	I_S [mA]	I_{Smax} ($V = V_{max}$) [A]	R_R [Ω]	R_{min} [Ω]	Ordering code
$V_{max} = 30 \text{ V DC or V AC, } V_R = 24 \text{ V DC or V AC}$							
1210	A606	90	180	0.50	27	17	B59606A0110A062
1210	A607	70	130	0.40	55	30	B59607A0120A062
$V_{max} = 60 \text{ V DC or V AC, } V_R = 42 \text{ V DC or V AC}$							
0603	A622	22	47	0.22	220	150	B59622A0090A062
$V_{max} = 80 \text{ V DC or V AC, } V_R = 63 \text{ V DC or V AC}$							
0603	A623	15	33	0.15	470	300	B59623A0090A062
1210	A707	50	90	0.30	125	75	B59707A0120A062
$V_{max} = 265 \text{ V DC or V AC, } V_R = 230 \text{ V DC or V AC}$							
1210	A807	15	40	0.20	400	200	B59807A0090A062
$V_{max} = 400 \text{ V DC or V AC, } V_R = 230 \text{ V DC or V AC}$							
1210	A907	12	22	0.15	1500	640	B59907A0120A062
$V_{max} = 30 \text{ V DC or V AC, } V_R = 24 \text{ V DC or V AC}$							
4032	P1301	205	420	1.60	3.1	1.85	B59301P1080A062
3225	P1201	165	340	1.00	4.6	2.70	B59201P1080A062
3225	P1101	90	185	0.70	13.0	7.80	B59101P1080A062
4032	P1301	310	640	1.60	3.1	1.85	B59301P1120A062
3225	P1201	265	545	1.00	4.6	2.70	B59201P1120A062
3225	P1101	170	355	0.70	13.0	7.80	B59101P1120A062
$V_{max} = 80 \text{ V DC or V AC, } V_R = 63 \text{ V DC or V AC}$							
4032	P1315	80	165	1.60	16.0	9.60	B59315P1080A062
3225	P1215	65	135	1.00	25.0	15.00	B59215P1080A062
3225	P1115	40	85	0.70	55.0	32.20	B59115P1080A062
4032	P1315	150	310	1.60	16.0	9.60	B59315P1120A062
3225	P1215	100	210	1.00	25.0	15.00	B59215P1120A062
3225	P1115	70	145	0.70	55.0	32.20	B59115P1120A062
$V_{max} = 265 \text{ V AC, } V_R = 230 \text{ V AC}$							
	G1085	180	400	1.00 @ 230 V	10.0	8.80	B59085G1120A161
	G1080	130	270	2.80 @ 230 V	25.0	21.00	B59080G1120B262
	G1084	90	190	2.50 @ 230 V	50.0	40.00	B59084G1120A161

Important information: Some parts of this publication contain statements about the suitability of our products for certain areas of application. These statements are based on our knowledge of typical requirements that are often placed on our products. We expressly point out that these statements cannot be regarded as binding statements about the suitability of our products for a particular customer application. It is incumbent on the customer to check and decide whether a product is suitable for use in a particular application. This publication is only a brief product survey which may be changed from time to time. Our products are described in detail in our data sheets. The *Important notes* (www.epcos.com/ImportantNotes) and the product-specific *Cautions and warnings* must be observed. All relevant information is available through our sales offices.

Dimensional drawings in mm

EIA case sizes 3225 and 4032

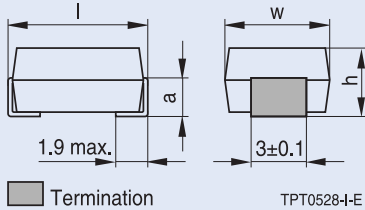

Case size	h ±0.5	w ±0.5	l ±0.5	a ±0.3
3225	3.3	6.3	8.0	1.7
4032	3.3	8.0	10.0	2.3

Solder pads

EIA case size 3225

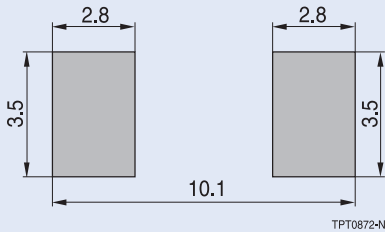

EIA case size 4032

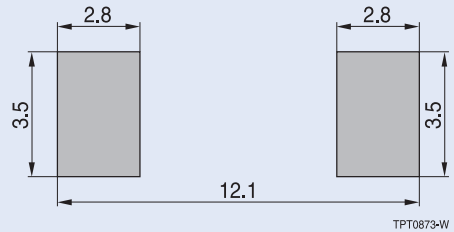

Recommended maximum dimensions

SMD disks

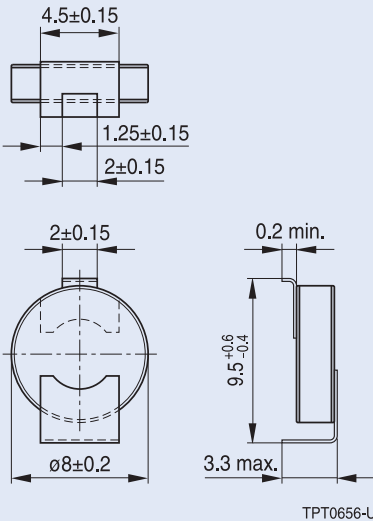

Solder pad

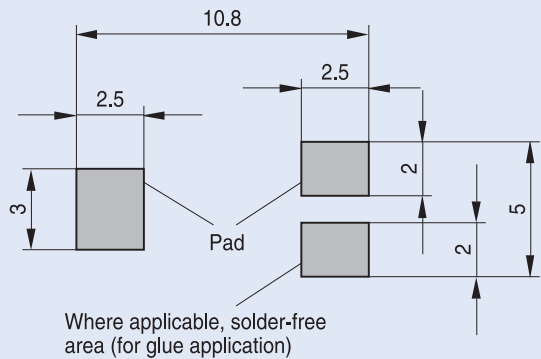

Recommended maximum dimensions

