



Assembly Instructions

GENERAL

Optoelectronic semiconductor devices can be mounted in any position. Connection wires may be bent provided the bend is not less than 1.5 mm from the bottom of the case. During bending, no forces must be transmitted from the pins to the case (e.g., by spreading the pins).

If the device is to be mounted near heat generating components, the resultant increase in ambient temperature must be taken into account.

SOLDERING INSTRUCTIONS

Protection against overheating is essential when a device is being soldered. It is recommended, therefore, that the connection wires are left as long as possible. The time during which the specified maximum permissible device junction temperature is exceeded at the soldering process should be as short as possible (one minute maximum). In the case of plastic encapsulated devices, the maximum permissible soldering temperature is governed by the maximum permissible heat that may be applied to the encapsulant rather than by the maximum permissible junction temperature.

The maximum soldering iron (or solder bath) temperatures are given in Tab. 1. At temperatures far above the glass transition point, the epoxy softens plastically. During soldering, no forces must be transmitted from the pins to the case (e.g., by spreading the pins or by creation of mechanical tension during devices insertion, clinching or crimping processes).

	IRON SOLDERING			WAVE SOLDERING		
	IRON TEMPERATURE	DISTANCE OF THE SOLDERING POSITION FROM THE LOWER EDGE OF THE CASE	MAXIMUM ALLOWABLE SEE TEMPERATURE-SOLDERING TIME	SOLDERING TEMPERATURE FROM THE LOWER TIME PROFILES	DISTANCE OF THE SOLDERING POSITION EDGE OF THE CASE	MAXIMUM ALLOWABLE SOLDERING TIME
Devices in plastic case ≥ 3 mm	≤ 260 °C ≤ 300 °C	≥ 2.0 mm ≥ 5.0 mm	5 s 3 s	235 °C 260 °C	≥ 2.0 mm ≥ 2.0 mm	8 s 5 s
Devices in plastic case < 3 mm	≤ 300 °C	≥ 5.0 mm	3 s	260 °C	≥ 2.0 mm	3 s
TELUX	≤ 260 °C	≥ 2.0 mm	5 s	260 °C	≥ 1.5 mm	5 s
SMD	n.A	n.A	n.A	260 °C	n.A	5 s
Mini	n.A	n.A	n.A	n.A	n.A	n.A
0603 LED	n.A	n.A	n.A	n.A	n.A	n.A

Table 1. Maximum Soldering Temperatures

MOISTURE SENSITIVITY LEVELS (JEDEC LEVEL)						
LEVEL	TIME	CONDITIONS	SOAK REQUIREMENTS			
			FLOOR LIFE		ACCELERATED EQUIVALENT	
			STANDARD	STANDARD	TIME (HOURS)	CONDITIONS
1	Unlimited	≤ 30 °C/85 % RH	168 + 5 /- 0	85 °C/85 % RH		
2	1 year	≤ 30 °C/85 % RH	168 + 5 /- 0	85 °C 60 % RH		
2a	4 weeks	≤ 30 °C/85 % RH	696 + 5 /- 0	30 °C/60 % RH	120 + 1 /- 0	60 °C/60 % RH
3	168 hours	≤ 30 °C/85 % RH	192 + 5 /- 0	30 °C/60 % RH	40 + 1 /- 0	60 °C/60 % RH
4	72 hours	≤ 30 °C/85 % RH	96 + 2 /- 0	30 °C/60 % RH	20 + 0.5 /- 0	60 °C/60 % RH
5	48 hours	≤ 30 °C/85 % RH	72 + 2 /- 0	30 °C/60 % RH	20 + 0.5 /- 0	60 °C/60 % RH
5a	24 hours	≤ 30 °C/85 % RH	72 + 2 /- 0	30 °C/60 % RH	20 + 0.5 /- 0	60 °C/60 % RH
6	Time on Label (TOL)	≤ 30 °C/85 % RH	TOL	30 °C/60 % RH		

Table 2. JEDEC Level

SOLDERING METHODS

There are several methods in use to solder devices on to the substrate. Some of them are listed in the following:

(a) Soldering in the vapor phase

Soldering in saturated vapor is also known as condensation soldering. This soldering process is used as a batch system (dual vapor system) or as a continuous single vapor system. Both systems may also include preheating of the assemblies to prevent high temperature shock and other undesired effects.

(b) Reflow soldering

The heating rate in an IR furnace depends on the absorption coefficients of the material surfaces and on the ratio of the component's mass to its irradiated surface.

The temperature of parts in an IR furnace, with a mixture of radiation and convection, cannot be determined in advance. Temperature measurement may be performed by measuring the temperature of a certain component while it is being transported through the furnace.

The temperatures of small components, soldered together with larger ones, may rise up to 280 °C. Influencing parameters on the internal temperature of the component are as follows:

- Time and power
- Mass of the component
- Size of the component
- Size of the printed circuit board
- Absorption coefficient of the surfaces
- Packing density
- Wavelength spectrum of the radiation source
- Ratio of radiated and convected energy

Temperature-time profiles of the entire process and the influencing parameters are given in figure 1.

(c) Wave soldering

In wave soldering, one or more continuously replenished waves of molten solder are generated, while the substrates to be soldered are moved in one direction across the wave's crest.

Temperature-time profiles of the entire process are given in figure 2.

(d) Iron soldering

This process cannot be carried out in a controlled way. It should not be considered for use in applications where reliability is important. There is no SMD classification for this process.

(e) Laser soldering

This is an excess heating soldering method. The energy absorbed may heat the device to a much higher temperature than desired. There is no SMD classification for this process at the moment.

(f) Resistance soldering

This is a soldering method which uses temperature controlled tools (thermodes) for making solder joints. There is no SMD classification for this process at the moment.

(g) Solderability of parts with pure tin plating and SnPb solder at lower temperature.

Soldering of parts can also be processed below 215 °C. In a test the solderability of SMD LEDs in PLCC2 package was tested with:

- Plating Sn 10 - 18 µm on CuFe lead frame
- Pre aging 155 °C, 4 h
- Bath temperature 205 °C
- Dipping time 2 s

All the samples showed 100 % wetting after this test and the diffusion of the SnPb in the Sn surface was completed. To check the solderability of individual parts on lower soldering temperatures we recommend to do a suitable test like the above one.

Warning

Devices in PLCC-packages are sensitive to moisture release if they are subjected to infrared reflow or a similar solder process (e.g. wave soldering). After opening the bag, they must be:

1. stored at ambient of < 20 % relative humidity (RH)
2. mounted within required time acc. Jedec Level printed on label. (< 30 °C/60 % RH)

Devices require baking before mounting if 1. or 2. is not met and humidity indicator card is > 20 % at 23 ± 5 °C. If baking is required, devices may be baked for 192 hours at 40 °C + 5 °C - 0 °C and < 5 % RH.

For any devices avoid any mechanical stress on the package via the leads.

TEMPERATURE-TIME PROFILES

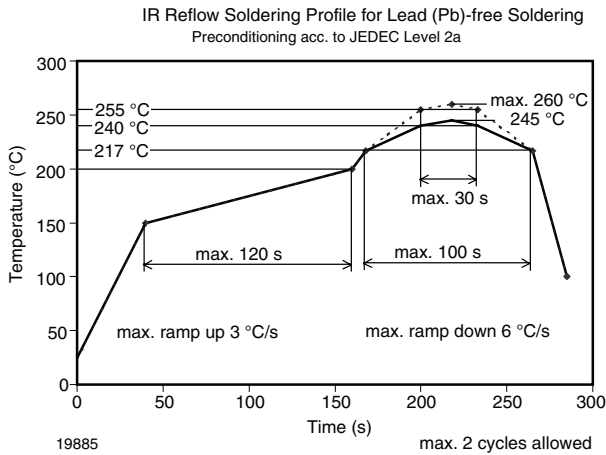

Figure 1. Vishay Lead (Pb)-free Reflow Soldering Profile (acc. to J-STD-020C)

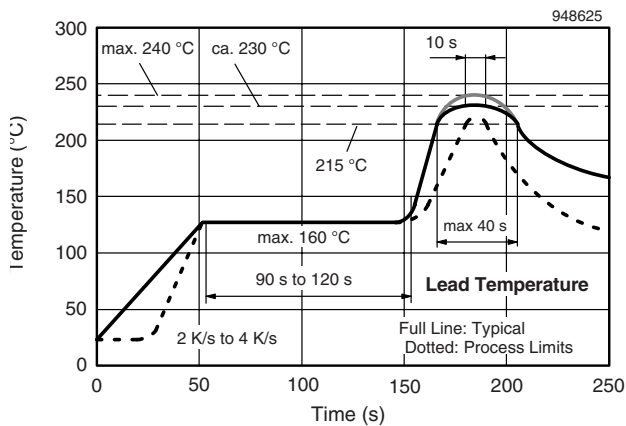

Figure 2. Vishay Lead (Pb)-free Reflow Soldering Profile

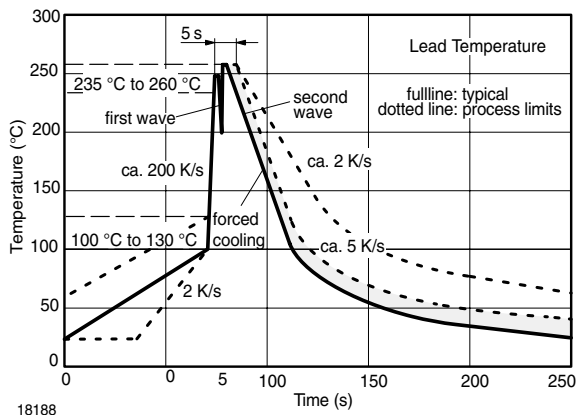

Figure 3. Double wave soldering of opto devices (all packages)

HEAT REMOVAL

To keep the thermal equilibrium, the heat generated in the semiconductor junction(s) during operation will always move to outside the device.

In the case of low power devices, the natural heat conductive path between the case and surrounding air is usually adequate for this purpose. The heat generated in the junction is conveyed to the case or header by conduction rather than convection. A measure of the effectiveness of heat conduction is the inner thermal resistance or thermal resistance junction case, R_{thJC} , the value of which is governed by the construction of the device.

Any heat transfer from the case to the surrounding air involves radiation convection and conduction, the effectiveness of transfer being expressed in terms of an R_{thCA} value, i.e., the external or case ambient thermal resistance. The total thermal resistance, junction ambient is consequently:

$$R_{thJA} = R_{thJC} + R_{thCA}$$

The total maximum power dissipation, P_{totmax} of a semiconductor device can be expressed as follows:

$$P_{totmax} = \frac{T_{jmax} - T_{amb}}{R_{thJA}} = \frac{T_{jmax} - T_{amb}}{R_{thJC} + R_{thCA}}$$

where:

T_{jmax} the maximum allowable junction temperature

T_{amb} the highest ambient temperature likely to be reached under the most unfavorable conditions

R_{thJC} the thermal resistance, junction case

R_{thJA} the thermal resistance, junction ambient, is specified for the components. The following diagram shows how the different installation conditions effect the thermal resistance

R_{thCA} the thermal resistance, case ambient, depends on cooling conditions. If a heat dissipator or sink is used, R_{thCA} depends on the thermal contact between case and heat sink, heat propagation conditions in the sink and the rate at which heat is transferred to the surrounding air.

For further details about thermal management see „TELUX Application Note“.

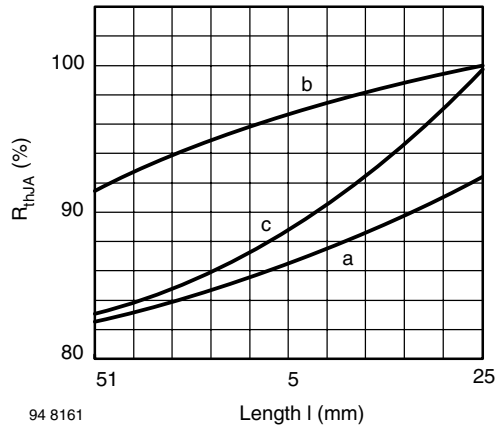

94 8161
Figure 4. Thermal resistance junction / ambient vs. lead length

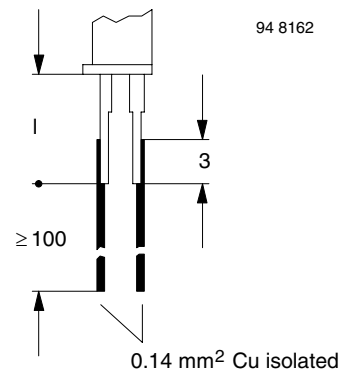

94 8162
Figure 6. In the case of wire contacts (curve b, figure 3)

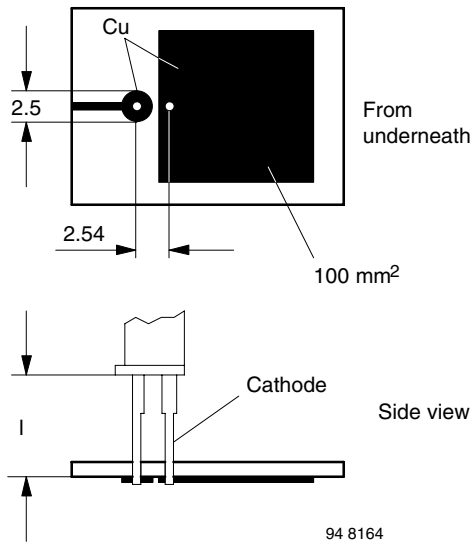

94 8164
Figure 5. In the case of assembly on PC board with heatsink (curve a, figure 3)

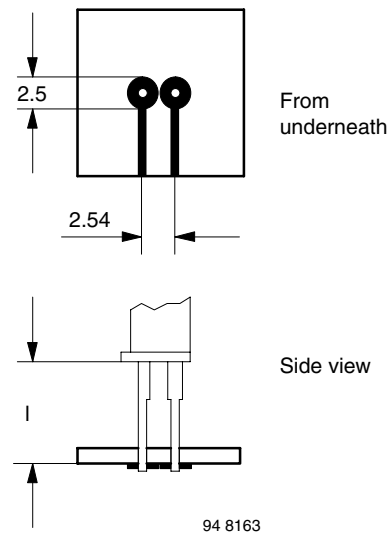

94 8163
Figure 7. In the case of assembly on PC board, no heatsink (curve c, figure 3)



CLEANING

Soldered assemblies are washable with the following solvents:

1. A mixture of 1, 1.2-trichlorotrifluoroethane, $70 \pm 5\%$ by weight and 2-propanol (isopropyl alcohol), $30 \pm 5\%$ by weight.
Commercially available grades (industrial use) should be used. Warning: The component 1, 1.2-trichlorofluoroethane is hazardous to the environment. Therefore this solvent must not be used where the solvent specified in 2 or 3 is adequate.
2. 2-propanol (isopropyl alcohol).
Commercially available grades (industrial use) should be used.
3. Demineralized or distilled water having a resistivity of not less than $500 \text{ m}\Omega$ corresponding to a conductivity of 2 mS/m

Caution: The use of tetrachlor, acetone, trichloroethylene or similar is **NOT ALLOWED!**

WARNING

Exceeding any one of the ratings (soldering, cleaning or short time exceeding the railings) could result in irreversible changes in the ratings.