



Main

Range of product	Zelio Time
Product or component type	Optimum industrial timing relay
Component name	RE8
Time delay type	Qc
Time delay range	0.1...10 s
[Us] rated supply voltage	110...240 V AC, 50/60 Hz 24 V AC/DC, 50/60 Hz
Sale per indivisible quantity	10

Complementary

Discrete output type	Relay
Contacts material	90/10 silver nickel contacts
Width pitch dimension	22.5 mm
Voltage range	0.9...1.1 Us
Connections - terminals	Screw terminals 2 x 1.5 mm ² , flexible cablewith cable end Screw terminals 2 x 2.5 mm ² , flexible cablewithout cable end
Tightening torque	0.6...1.1 N.m
Setting accuracy of time delay	+/- 20 % of full scale
Repeat accuracy	< 1 %
Voltage drift	< 2.5 %/V
Temperature drift	< 0.2 %/°C
Minimum pulse duration	60 ms
Reset time	50 ms
Maximum switching voltage	250 V
Mechanical durability	20000000 cycles
[Ith] conventional free air thermal current	8 A
[Ie] rated operational current	<= 2 A at 24 V, DC-13 for 70 °C conforming to IEC 60947-5-1/1991 <= 2 A at 24 V, DC-13 for 70 °C conforming to VDE 0660 <= 3 A at 24 V, AC-15 for 70 °C conforming to IEC 60947-5-1/1991 <= 3 A at 24 V, AC-15 for 70 °C conforming to VDE 0660 <= 0.1 A at 250 V, DC-13 for 70 °C conforming to IEC 60947-5-1/1991 <= 0.1 A at 250 V, DC-13 for 70 °C conforming to VDE 0660 <= 0.2 A at 115 V, DC-13 for 70 °C conforming to IEC 60947-5-1/1991 <= 0.2 A at 115 V, DC-13 for 70 °C conforming to VDE 0660
Minimum switching capacity	10 mA at 12 V
Marking	CE
Overvoltage category	III conforming to IEC 60664-1
[Ui] rated insulation voltage	250 V conforming to IEC 300 V conforming to CSA
Supply disconnection value	> 0.1 Uc
Operating position	Any position without derating factor
Surge withstand	2 kV conforming to IEC 61000-4-5 level 3
Power consumption in VA	13 VA at 240 V 0.9 VA at 24 V 2.5 VA at 110 V
Power consumption in W	0.5 W at 24 V
Terminal description	(15-16-18)OC_OFF (A1-B1)CO ALT

The information provided in this documentation contains general descriptions and/or technical characteristics of the performance of the products contained herein. This documentation is not intended as a substitute for and is not to be used for determining suitability or reliability of these products for specific user applications. It is the duty of any such user or integrator to perform the appropriate and complete risk analysis, evaluation and testing of the products with respect to the relevant specific application or use thereof. Neither Schneider Electric Industries SAS nor any of its affiliates or subsidiaries shall be responsible or liable for misuse of the information contained herein.

Height	78 mm
Width	22.5 mm
Depth	80 mm
Product weight	0.11 kg

Environment

Immunity to microbreaks	3 ms
Standards	EN/IEC 61812-1
Product certifications	CSA GL UL
Ambient air temperature for storage	-40...85 °C
Ambient air temperature for operation	-20...60 °C
Relative humidity	15...85 % 3K3 conforming to IEC 60721-3-3
Vibration resistance	0.35 mm 10...55 Hz conforming to IEC 60068-2-6
Shock resistance	15 gn (duration = 11 ms conforming to IEC 60068-2-27)
IP degree of protection	IP20 (terminals) IP50 (casing)
Pollution degree	3 conforming to IEC 60664-1
Dielectric test voltage	2.5 kV
Non-dissipating shock wave	4.8 kV
Resistance to electrostatic discharge	6 kV in contact conforming to IEC 61000-4-2 level 3 8 kV in air conforming to IEC 61000-4-2 level 3
Resistance to electromagnetic fields	10 V/m conforming to IEC 61000-4-3 level 3
Resistance to fast transients	2 kV conforming to IEC 61000-4-4 level 3
Disturbance radiated/conducted	CISPR11 group 1- class A CISPR22 - class A
RoHS EUR status	Compliant
RoHS EUR conformity date	0625

Function Qc: Star-Delta Timing

Description

On energisation, the star contact closes instantaneously and timing starts.

At the end of the timing period, the star contact opens.

After a 50 ms pause, the delta contact closes and remains in this position.

Function: 1 Output

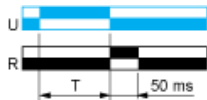

Legend

 Relay de-energised

 Relay energised

 Output open

 Output closed

C Control contact

G Gate

R Relay or solid state output

R1/ 2 timed outputs

R2

R2 The second output is instantaneous if the right position is selected
inst.

T Timing period

Ta Adjustable On-delay

Tr Adjustable Off-delay

U Supply

Width 22.5 mm

Rail Mounting

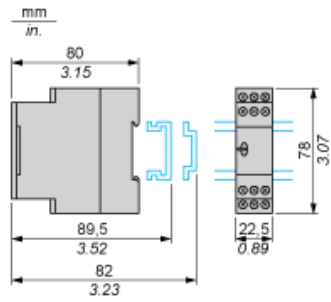

Screw Fixing

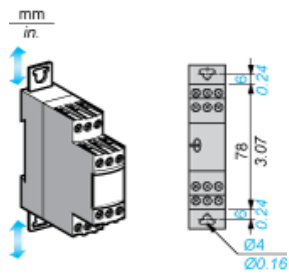

Internal Wiring Diagram

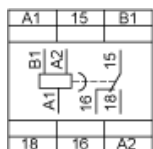

Recommended Application Wiring Diagram

Control

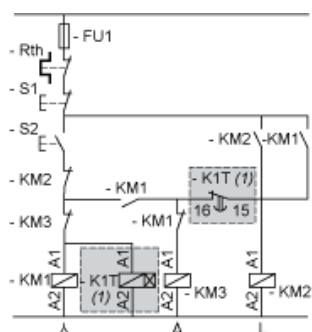

K1T Timing relay for star-delta starters.

NOTE: Correct operation of the star-delta starter associated with the relay is only possible if the wiring diagram is strictly complied with.

Power

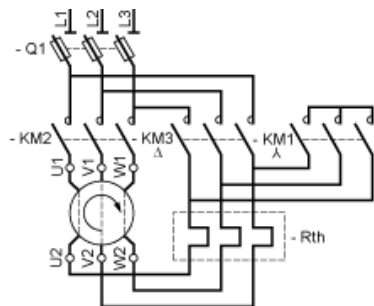

Performance Curves

A.C. Load Curve 1

Electrical durability of contacts on resistive loading millions of operating cycles

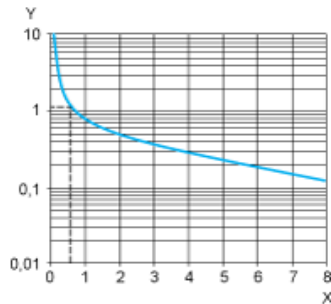

X Current broken in A
Y Millions of operating cycles

A.C. Load Curve 2

Reduction factor k for inductive loads (applies to values taken from durability curve 1).

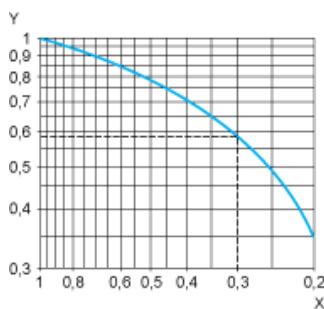

X Power factor on breaking (cos φ)
Y Reduction factor k

Example: An LC1-F185 contactor supplied with 115 V/50 Hz for a consumption of 55 VA or a current consumption equal to 0.1 A and cos φ = 0.3. For 0.1 A, curve 1 indicates a durability of approximately 1.5 million operating cycles. As the load is inductive, it is necessary to apply a reduction coefficient k to this number of cycles as indicated by curve 2. For cos φ = 0.3: k = 0.6 The electrical durability therefore becomes: 1.5 10⁶ operating cycles x 0.6 = 900 000 operating cycles.

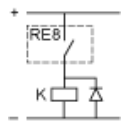

D. C. Load Limit Curve

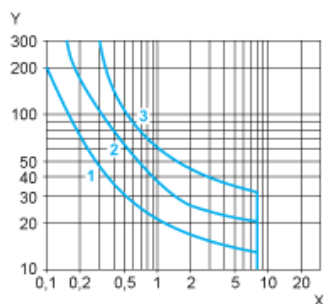

X Current in A
Y Voltage in V
1 L/R = 20 ms
2 L/R with load protection diode
3 Resistive load