

Terminals, W-Series

Terminals, W-Series	Overview W-Series	E.2
	Feed-through terminals	E.4
	Double level terminals	E.14
	Modular PE terminals	E.19
	Test-disconnect terminals	E.29
	Fuse terminals	E.35
	Installation terminals	E.44
	Test-disconnect terminals	E.52
	Terminals with spring-loaded cable clamps	E.64
	Initiator and actuator terminals	E.70
	Motor connection terminals	E.74
	Plug-in modular terminals	E.76
	Terminals for temperature measuring circuits	E.80
	Terminals for retrofitting of electronic components	E.81
	Terminals with electronic components	E.82
	Power distribution blocks WPDB	E.88
Terminals, TS 15	Mini terminals TS 15	E.96
Stud terminals	Overview Stud terminals – WF/WFF	E.100
	Overview Stud terminals – ST 4000	E.102
	Single-/twin stud terminals – WF/WFF	E.104
	Twin stud terminals – ST 4000	E.106
Accessories	Accessories W-Series	E.112
Terminals, SAK-Series	Overview SAK-Series	E.144

W-Series / Clamping yoke screw connection technology

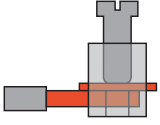

For a long time now, Weidmüller's W-Series terminal with screw clamp connection technology, has set the standard. With many advantages, the W-Series remains market leader and unsurpassed.

The W-Series offers solutions for conductor cross-sections from 0.06 to 300 mm² and for all common electrical functions. Another advantage is the choice of plug-in (ZQV) or screw-in (WQV) cross-connections within one modular terminal. It brings considerable time savings compared to all other screw terminals on the market.

Thanks to the patented design of Weidmüller's W-Series screw connection technology it is possible for two conductors of the same cross-section to be connected in one and the same clamping point without difficulty.

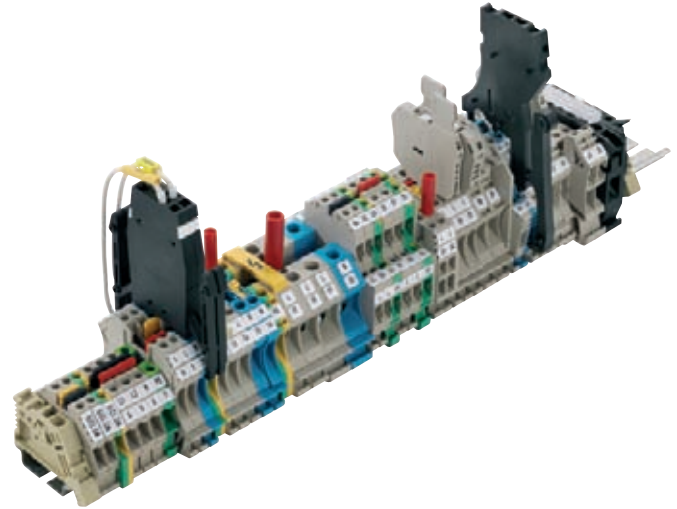

Versions

W-standard

- Same contour design from 2.5 to 10 mm²
- Conductor sizes from 0.05 to 300 mm²
- Large clamping range



W-compact

- Smaller size
- Identified by an "N" in the type designation
- Conductor sizes from 0.13 to 150 mm²

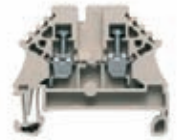

Product overview

Rated cross-section	1.5 mm ²		2.5 mm ²		4 mm ²		6 mm ²		10 mm ²		16 mm ²		35 mm ²	
	Standard	Compact	Standard	Compact	Standard	Compact	Standard	Compact	Standard	Compact	Standard	Compact	Standard	Compact
Feed-through terminals														
2 connections	•	•	•	•	•	•	•	•	•	•	•	•	•	•
3 and 4 connections	•	•	•	•	•	•	•	•	•	•	•	•	•	•
PE terminals														
2 connections	•	•	•	•	•	•	•	•	•	•	•	•	•	•
3 and 4 connections	•	•	•	•	•	•	•	•	•	•	•	•	•	•
Fuse terminals			•	•	•	•	•	•	•	•	•	•	•	•
Disconnect test terminal blocks			•	•	•	•	•	•	•	•	•	•	•	•
3 and 4 connections	•	•	•	•	•	•	•	•	•	•	•	•	•	•
3-conductor installation terminals	•	•	•	•	•	•	•	•	•	•	•	•	•	•
N-conductor disconnect terminals	•	•	•	•	•	•	•	•	•	•	•	•	•	•
Plug-in terminals	•	•	•	•	•	•	•	•	•	•	•	•	•	•
Initiator/Actuator terminals	•	•	•	•	•	•	•	•	•	•	•	•	•	•
Terminals with electronic components	•	•	•	•	•	•	•	•	•	•	•	•	•	•
Miniature terminals for TS 15	•	•	•	•	•	•	•	•	•	•	•	•	•	•
Rated cross-section	50 mm ²		70 mm ²		95 mm ²		120 mm ²		150 mm ²		240 mm ²			
	Standard	Compact	Standard	Compact	Standard	Compact	Standard	Compact	Standard	Compact	Standard	Compact		
Feed-through terminals														
2 connections	•	•	•	•	•	•	•	•	•	•	•	•	•	•
PE terminals														
2 connections	•	•	•	•	•	•	•	•	•	•	•	•	•	•
N-conductor disconnect terminals														
2 connections	•	•	•	•	•	•	•	•	•	•	•	•	•	•

1 The connection

Separation of electrical and mechanical function thus providing galvanic isolation.

- Hardened steel screw clamp technology.
- Busbar of copper for low through resistance.
- Tin-plated surface for minimum contact resistances.

2 Cross-connections, also pluggable

- Screw-in or plug-in cross-connections as required
- For screw terminals, the pluggable cross-connection (ZQV) is unique, with considerable time savings
- Cross-connections with up to 10 poles available as standard for 2.5 and 4
- 20-pole cross-connections (ZQV) available for custom fabrication

3 Easy to use

- Can be clipped to or removed from the terminal rail in either direction
- Features captive screw.
- Recessed clamping screw position provides guide for screwdriver
- All parts fitted captive within the terminal
- Numerous labelling options

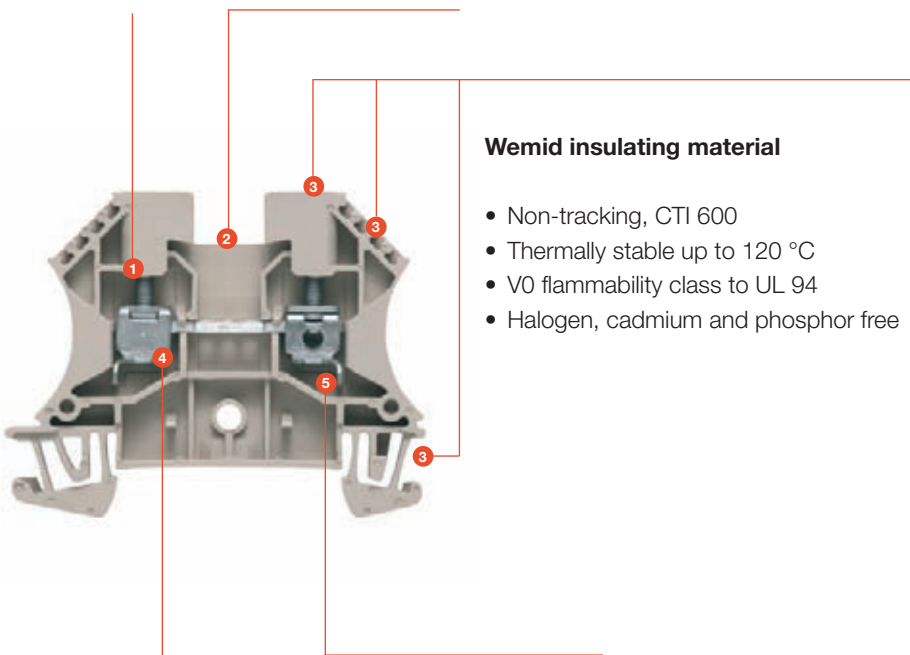

Wemid insulating material

- Non-tracking, CTI 600
- Thermally stable up to 120 °C
- V0 flammability class to UL 94
- Halogen, cadmium and phosphor free

Common profiles

- Identical size from 2.5 to 10 mm²
- Minimum number of different accessories = lower costs and better logistics
- Easy planning

Standards and directives

The reliable contact and dependability of the Weidmüller systems are verified by:

- Type tests to IEC 60947-7-1/-2/-3
- National and international approvals
- A large portfolio of UL and CSA approvals
- W-Series certified for railway applications (see chapter on stud terminals)
- ATEX approval (see certificate on Weidmüller website)
- All materials checked for conformity with the latest environmental directives and RoHS requirements
- IECEx approved

4 Reliable contact

- W-Series offers galvanic isolation by providing a steel screw clamp technology for mechanical function, with copper busbar for low through resistance and electrical function.
- No maintenance: no need to retighten the clamping screw
- Vibration-proof connection: many W-terminals certified for railway use to EN 61373
- Highest contact force of all connection systems

5 Safe to use

- Shock protection with connected conductors, even when cross-connected.
- Terminals supplied with open clamping point. In addition, the misplugging safeguard prevents conductors from being inserted incorrectly
- Embossing on clamping yoke and current bar engage so that even the smallest conductors are reliably clamped; large conductors and also 2 conductors are gripped in the middle



Feed-through terminals

Identical profiles from 2.5 to 10 mm² with uniform end and partition plates. An unsurpassed combination of many advantages!

Their small size compared to the respective rated cross-section makes the modular terminals with the compact design very popular.

In hazardous area applications, the installation instructions and the rated data specifications for accessories given in the technical appendix must be followed.

Width/Length/height with TS35x7.5	mm
max. current / max. cond. cross-section	A/mm ²
Max. clamping range	mm ²











Technical data

Rated data	
Rated voltage	V
Rated current	A
Rated cross-section	mm ²
Rated impulse voltage / Pollution severity	kV/-
Gauge to IEC 60947-1 / UL94 Flammability class	
Approvals	
Clamped conductors (H05V/H07V)	
solid / stranded	mm ²
flexible / Stranded wire with end ferrules	mm ²
Tightening torque range (clamping screw)	
Stripping length / Blade size	mm/-
2 conductors with same cross-section (H05V/H07V)	
solid / stranded	mm ²
flexible / Stranded wire with end ferrules	mm ²
Note	

Ordering data

Version	
	Dark beige Wemid
	Blue Wemid
Note	

Accessories

Pluggable cross-connection	
	2-pole
	3-pole
	4-pole
	10-pole
	20-/24-pole
Screwable cross-connection	
	2-pole
	3-pole
	4-pole
	10-pole
End plate / partition	
	Dark beige Wemid
	Blue Wemid
	Dark beige Wemid
	Blue Wemid
End bracket	
	Dark beige Wemid
	Dark beige Wemid
Testing / Checking	
	Standard
	With assembly peg
Cover	
	With lightning flash symbol
	blank
Marking systems	
	(see assortment in catalogue 7)
	Marking tags
For detailed information on other accessories and applications, refer to the „Accessories“ section	

WDU 1.5/ZZ

1.5 mm²

Twin connection

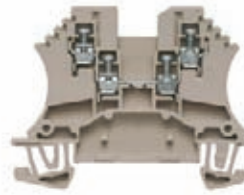

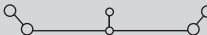
5.1 x 60 x 47	
23 / 2.5	
0.13...2.5	

IEC 60947-7-1		Ex e II		II 2 G D	
IEC	UL	CSA	EN 60079-7	IEC	UL
800	300	300	550	800	300
17.5	10	10	15	24	20
1.5	AWG 26...12	AWG 26...12	1.5	2.5	AWG 30...12
8 / 3					
A1 / V-0					
KEMA 98ATEX1685 U					
Rated connection			Further connection		
0.5...2.5 / 0.5...2.5			0.5...2.5 / 1.5...2.5		
0.5...1.5 / 0.5...1.5			0.5...1.5 / 0.5...1.5		
0.4...0.6 Nm (M 2.5)			0.4...0.6 Nm (M 2.5)		
7 / 0.6 x 3.5 mm			7 / 0.6 x 3.5 mm		
0.5...1					
0.5...1 / 0.5...0.75					
Note the max. current of the terminal (23 A) when using the WQV cross-connector!					

Type	Qty	Order No.
WDU 1.5/ZZ	100	1031400000
WDU 1.5/ZZ BL	100	1031480000

Type	current	Qty	Order No.
ZQV 2.5N/2 GE	24 A	60	1693800000
ZQV 2.5N/3 GE	24 A	60	1693810000
ZQV 2.5N/4 GE	24 A	60	1693820000
ZQV 2.5N/10 GE	24 A	20	1693880000
ZQV 2.5N/20 GE	24 A	20	1909000000
Width			
WAP 2.5-10	1.5 mm	50	1050000000
WAP 2.5-10 BL	1.5 mm	50	1050080000
WAP 16+35 WTW 2.5-10	1.5 mm	20	1050100000
WAP 16+35 WTW 2.5-10 BL	1.5 mm	20	1050180000
Width			
WEW 35/2	8 mm	100	1061200000
Width			
WTA 2 WDU2.5-10	5 mm	25	1632320000
WTA 2/ZA WDU2.5-10	5 mm	25	1632330000
WAD 4 GE BED	4 mm	50	1072000000
WAD 4 WS	4 mm	50	1072100000
Width			
DEK 5/5 / WS 12/5			
Socket and test plug, see section „W-series accessories“			

WDU 2.5/1.5/ZR

2.5 mm²

Supplementary connection, right

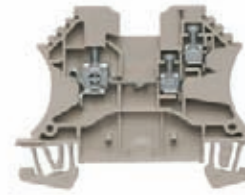

5.1 x 60 x 47	
32 / 4	
0.05...4	

IEC 60947-7-1		Ex e II		II 2 G D	
IEC	UL	CSA	EN 60079-7	IEC	UL
800	300	300	550	800	300
24	20	20	21	24	20
2.5	AWG 30...12	AWG 26...12	2.5	2.5	AWG 30...12
8 / 3					
A3 / A1 / V-0					
KEMA 98ATEX1685 U					
Rated connection			Further connection		
0.5...4 / 1.5...4			0.5...2.5 / 1.5...2.5		
0.5...4 / 0.5...2.5			0.5...1.5 / 0.5...1.5		
0.4...0.6 Nm (M 2.5)			0.4...0.6 Nm (M 2.5)		
10 / 0.6 x 3.5 mm			7 / 0.6 x 3.5 mm		
0.5...1					
0.5...1.5 / 0.5...1.5					
Note 2.5 mm ² conductor with wire end ferrule plus plastic collar only with collar optimised for diameter (order No. 1333100000, 500 pcs)					

Type	Qty	Order No.
WDU 2.5/1.5/ZR	100	1024700000
WDU 2.5/1.5/ZR BL	100	1024780000

Type	current	Qty	Order No.
ZQV 2.5N/2 GE	24 A	60	1693800000
ZQV 2.5N/3 GE	24 A	60	1693810000
ZQV 2.5N/4 GE	24 A	60	1693820000
ZQV 2.5N/10 GE	24 A	20	1693880000
ZQV 2.5N/20 GE	24 A	20	1909000000
Width			
WQV 2.5/2	32 A	50	1053660000
WQV 2.5/3	32 A	50	1053760000
WQV 2.5/4	32 A	50	1053860000
WQV 2.5/10	32 A	20	1054460000
Width			
WAP 2.5-10	1.5 mm	50	1050000000
WAP 2.5-10 BL	1.5 mm	50	1050080000
WAP 16+35 WTW 2.5-10	1.5 mm	20	1050100000
WAP 16+35 WTW 2.5-10 BL	1.5 mm	20	1050180000
Width			
WEW 35/2	8 mm	100	1061200000
Width			
WTA 2 WDU2.5-10	5 mm	25	1632320000
WTA 2/ZA WDU2.5-10	5 mm	25	1632330000
WAD 5 M. BL.	5 mm	50	1053460000
WAD 5 NEUTRAL	5 mm	50	1056060000
Width			
DEK 5/5 / WS 12/5			
Use a 2.5 / 1 mm ² conductor when using the WQB.			

WDU 2.5

2.5 mm²



5.1 x 60 x 47
32 / 4
0.05...4



IEC 60947-7-1 Ex e II II 2 G D

IEC	UL	CSA	EN 60079-7
800	600	600	550
24	25	20	21
2.5	AWG 30...12	AWG 26...12	2.5
8 / 3			
A3 / V-0			

KEMA 98ATEX1683 U

Rated connection	Further connection
0.5...4 / 1.5...4	
0.5...4 / 0.5...2.5	
0.4...0.6 Nm (M 2.5)	
10 / 0.6 x 3.5 mm	
0.5...1.5	
0.5...1.5 / 0.5...1.5	
2.5 mm ² conductor with wire end ferrule plus plastic collar only with collar optimised for diameter (order No. 1333100000, 500 pcs)	

Type	Qty	Order No.
WDU 2.5	100	1020000000
WDU 2.5 BL	100	1020080000

Rated voltage 400V when using cross-connection ZQV. See section „W-series accessories“ for colours available.

WDU 2.5N

2.5 mm²

With screwable cross-connection
Compact design



5.1 x 44 x 37.5
32 / 4
0.05...4

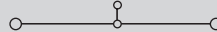

IEC 60947-7-1 Ex e II II 2 G D

IEC	UL	CSA	EN 60079-7
500	300	300	440
24	10	20	21
2.5	AWG 30...12	AWG 26...12	2.5
6 / 3			
A3 / V-0			

KEMA 98ATEX1683 U

Rated connection	Further connection
0.5...4 / 1.5...4	
0.5...4 / 0.5...2.5	
0.4...0.6 Nm (M 2.5)	
10 / 0.6 x 3.5 mm	
0.5...1.5	
0.5...1.5 / 0.5...1.5	
2.5 mm ² conductor with wire end ferrule plus plastic collar only with collar optimised for diameter (order No. 1333100000, 500 pcs)	

Type	Qty	Order No.
WDU 2.5N	100	1023700000
WDU 2.5N BL	100	1023780000

For colours available see section W-series accessories „Specific functions“

WDU 2.5N/ZQV

2.5 mm²

With pluggable cross-connection
Compact design



5.1 x 44 x 37.5
32 / 4
0.05...4

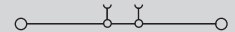

IEC 60947-7-1

IEC	UL	CSA
500	300	300
24	20	20
2.5	AWG 30...12	AWG 26...12
6 / 3		
A3 / V-0		

Rated connection	Further connection
0.5...4 / 1.5...4	
0.5...4 / 0.5...2.5	
0.4...0.6 Nm (M 2.5)	
10 / 0.6 x 3.5 mm	
0.5...1.5	
0.5...1.5 / 0.5...1.5	
2.5 mm ² conductor with wire end ferrule plus plastic collar only with collar optimised for diameter (order No. 1333100000, 500 pcs)	

Type	Qty	Order No.
WDU 2.5N ZQV	100	1040800000
WDU 2.5N ZQV BL	100	1040880000

Rated voltage 400 V when using the cross-connection ZQV.

Type	current	Qty	Order No.
ZQV 2.5N/2 GE	24 A	60	1693800000
ZQV 2.5N/3 GE	24 A	60	1693810000
ZQV 2.5N/4 GE	24 A	60	1693820000
ZQV 2.5N/10 GE	24 A	20	1693880000
ZQV 2.5N/20 GE	24 A	20	1909000000
current			
WQV 2.5/2	32 A	50	1053660000
WQV 2.5/3	32 A	50	1053760000
WQV 2.5/4	32 A	50	1053860000
WQV 2.5/10	32 A	20	1054460000
Width			
WAP 2.5-10	1.5 mm	50	1050000000
WAP 2.5-10 BL	1.5 mm	50	1050080000
WAP 16+35 WTW 2.5-10	1.5 mm	20	1050100000
WAP 16+35 WTW 2.5-10 BL	1.5 mm	20	1050180000
WEW 35/2	8 mm	100	1061200000
WTA 2 WDU2.5-10	5 mm	25	1632320000
WTA 2/ZA WDU2.5-10	5 mm	25	1632330000
WAD 5 M. BL.	5 mm	50	1053460000
WAD 5 NEUTRAL	5 mm	50	1056060000

DEK 5/5 / WS 12/5
Socket and test plug, see section „W Series accessories“. Ensure 2.5 mm² max. when using the WQB. Shielding rail LS 2.8 1056400000.

Type	Qty	Order No.
current		
WQV 2.5/2	32 A	50
WQV 2.5/3	32 A	50
WQV 2.5/4	32 A	50
WQV 2.5/10	32 A	20
Width		
WAP WDU2.5N/4N	1.5 mm	50
WAP WDU2.5N/4N BL	1.5 mm	50
EW 35	8.5 mm	50
WTA 1 WDU1.5	5 mm	25
WTA 1/ZA WDU1.5	5 mm	25
WAD 4 GE BED	4 mm	50
WAD 4 WS	4 mm	50

DEK 5/5 / WS 12/5
Socket and test plug, see section „W-series accessories“

Type	current	Qty	Order No.
ZQV 2.5N/2 GE	24 A	60	1693800000
ZQV 2.5N/3 GE	24 A	60	1693810000
ZQV 2.5N/4 GE	24 A	60	1693820000
ZQV 2.5N/10 GE	24 A	20	1693880000
ZQV 2.5N/20 GE	24 A	20	1909000000
Width			
WAP WDU2.5N/4N	1.5 mm	50	1060000000
WAP WDU2.5N/4N BL	1.5 mm	50	1060080000
EW 35	8.5 mm	50	0383560000
WTA 1 WDU1.5	5 mm	25	1632290000
WTA 1/ZA WDU1.5	5 mm	25	1632300000
WAD 4 GE BED	4 mm	50	1072000000
WAD 4 WS	4 mm	50	1072100000

DEK 5/5 / WS 12/5

Feed-through terminals

Identical profiles from 2.5 to 10 mm² with uniform end and partition plates. An unsurpassed combination of many advantages!

Their small size compared to the respective rated cross-section makes the modular terminals with the compact design very popular.

In hazardous area applications, the installation instructions and the rated data specifications for accessories given in the technical appendix must be followed.

Width/Length/height with TS35x7.5	mm
max. current / max. cond. cross-section	A/mm ²
Max. clamping range	mm ²



Technical data

Rated data	
Rated voltage	V
Rated current	A
Rated cross-section	mm ²
Rated impulse voltage / Pollution severity	kV/-
Gauge to IEC 60947-1 / UL94 Flammability class	
Approvals	
Clamped conductors (H05V/H07V)	
solid / stranded	mm ²
flexible / Stranded wire with end ferrules	mm ²
Tightening torque range (clamping screw)	
Stripping length / Blade size	mm/-
2 conductors with same cross-section (H05V/H07V)	
solid / stranded	mm ²
flexible / Stranded wire with end ferrules	mm ²
Note	

Ordering data

Version	
	Dark beige Wemid
	Blue Wemid
Note	

Accessories

Pluggable cross-connection	
	2-pole
	3-pole
	4-pole
	10-pole
	20-/24-pole
Screwable cross-connection	
	2-pole
	3-pole
	4-pole
	10-pole
End plate / partition	
	Dark beige Wemid
	Blue Wemid
	Dark beige Wemid
	Blue Wemid
End bracket	
	Dark beige Wemid
	Dark beige Wemid
Testing / Checking	
	Standard
	With assembly peg
Cover	
	With lightning flash symbol
	blank
Marking systems	
	(see assortment in catalogue 7)
	Marking tags
For detailed information on other accessories and applications, refer to the „Accessories“ section	

WDU 2.5N/600 UL

2.5 mm²

600V UL/CSA

Compact design



5.1 x 44 x 43.5
32 / 4
0.05...4

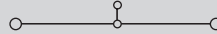

IEC 60947-7-1

IEC	UL	CSA
800	600	600
24	25	20
2.5	AWG 30...12	AWG 26...12
8 / 3		
A3 / V-0		



Rated connection	Further connection
0.5...4 / 1.5...4	
0.5...4 / 0.5...2.5	
0.4...0.6 Nm (M 2.5)	
10 / 0.6 x 3.5 mm	
0.5...1.5	
0.5...1.5 / 0.5...1.5	
2.5 mm ² conductor with wire end ferrule plus plastic collar only with collar optimised for diameter (order No. 1333100000, 500 pcs)	

WDU 4

4 mm²

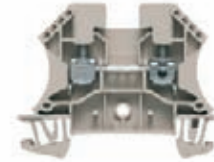

6.1 x 60 x 47
41 / 6
0.13...6



IEC 60947-7-1

Ex ell  II 2 G D

IEC	UL	CSA	EN 60079-7
800	600	600	690
32	35	35	28
4	AWG 22...10	AWG 26...10	4
8 / 3			
A4 / V-0			



KEMA 98ATEX1683 U

Rated connection	Further connection
0.5...6 / 1.5...6	
0.5...6 / 0.5...4	
0.5...1.0 Nm (M 3)	
10 / 0.6 x 3.5 mm	
0.5...2.5	
0.5...1.5 / 0.5...1.5	
Note max. current of terminal (41 A) when using WQV!	

Type	Qty	Order No.
WDU 2.5N/600UL	100	1730940000

Type	Qty	Order No.
WDU 4	100	1020100000
WDU 4 BL	100	1020180000
Rated voltage 400V when using cross-connection ZQV See section „W-series accessories“ for colours available.		

Type	current	Qty	Order No.
current			
WQV 2.5/2	32 A	50	1053660000
WQV 2.5/3	32 A	50	1053760000
WQV 2.5/4	32 A	50	1053860000
WQV 2.5/10	32 A	20	1054460000
Width			
WAP 16+35 WTW 2.5-10	1.5 mm	20	1050100000
WAP 16+35 WTW 2.5-10 BL	1.5 mm	20	1050180000
EW 35	8.5 mm	50	0383560000
WTA 1 WDU1.5	5 mm	25	1632290000
WTA 1/ZA WDU1.5	5 mm	25	1632300000
WAD 4 GE BED	4 mm	50	1072000000
WAD 4 WS	4 mm	50	1072100000
DEK 5/5 / WS 12/5			
Socket and test plug, see section „W-series accessories“			

Type	current	Qty	Order No.
ZQV 4N/2 GE	32 A	60	1758250000
ZQV 4N/3 GE	32 A	60	1762630000
ZQV 4N/4 GE	32 A	60	1762620000
ZQV 4N/10 GE	32 A	20	1758260000
ZQV 4N/20 GE	32 A	20	1909020000
WQV 4/2	32 A	50	1051960000
WQV 4/3	32 A	50	1054560000
WQV 4/4	32 A	50	1054660000
WQV 4/10	41 A	20	1052060000
Width			
WAP 2.5-10	1.5 mm	50	1050000000
WAP 2.5-10 BL	1.5 mm	50	1050080000
WAP 16+35 WTW 2.5-10	1.5 mm	20	1050100000
WAP 16+35 WTW 2.5-10 BL	1.5 mm	20	1050180000
WEW 35/2	8 mm	100	1061200000
WTA 3 WDU4	6 mm	25	1632350000
WTA 3/ZA WDU4	6 mm	25	1632360000
WAD 5 M. BL.	5 mm	50	1053460000
WAD 5 NEUTRAL	5 mm	50	1056060000
WS 12/6			
Socket and test plug, see section „W Series accessories“. Shielding rail LS 2.8 1056400000.			

WDU 4/ZZ

4 mm²

Twin connection

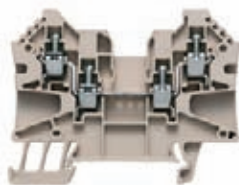

6.1 x 70 x 53.5
32 / 6
0.13...6

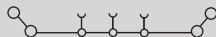

IEC 60947-7-1		Ex e II	
IEC	UL	CSA	EN 60079-7
800	600	600	
32	30	30	
4	AWG 30...10	AWG 30...10	4
8 / 3			
A4 / V-0			

Rated connection		Further connection
0.5...6 / 0.5...6		
0.5...4 / 0.5...4		
0.5...0.8 Nm (M 3)		
10 / 0.6 x 3.5 mm		
0.5...1.5		
0.5...1.5 / 0.5...1.5		

Type	Qty	Order No.
WDU 4/ZZ	50	1905060000

Type	current	Qty	Order No.
ZQV 4N/2 GE	32 A	60	1758250000
ZQV 4N/3 GE	32 A	60	1762630000
ZQV 4N/4 GE	32 A	60	1762620000
ZQV 4N/10 GE	32 A	20	1758260000
ZQV 4N/20 GE	32 A	20	1909020000
Width			
WAP WDU/WTR4/ZZ	1.5 mm	50	1905150000
WEW 35/2	8 mm	100	1061200000
DEK 5/6 / WS 12/6			

WDU 4/ZR

4 mm²

Supplementary connection, right



6.1 x 63.5 x 53.5
32 / 6
0.13...6

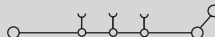

IEC 60947-7-1		Ex e II	
IEC	UL	CSA	EN 60079-7
800	600	600	
32	30	30	
4	AWG 30...10	AWG 30...10	4
8 / 3			
A4 / V-0			

Rated connection		Further connection
0.5...6 / 0.5...6		
0.5...4 / 0.5...4		
0.5...0.8 Nm (M 3)		
10 / 0.6 x 3.5 mm		
0.5...1.5		
0.5...1.5 / 0.5...1.5		

Type	Qty	Order No.
WDU 4/ZR	50	1905140000

Type	current	Qty	Order No.
ZQV 4N/2 GE	32 A	60	1758250000
ZQV 4N/3 GE	32 A	60	1762630000
ZQV 4N/4 GE	32 A	60	1762620000
ZQV 4N/10 GE	32 A	20	1758260000
ZQV 4N/20 GE	32 A	20	1909020000
Width			
WAP WDU/WTR4/ZR	1.5 mm	50	1905070000
WEW 35/2	8 mm	100	1061200000
DEK 5/6 / WS 12/6			

WDU 4N

4 mm²

Compact design



6.1 x 44 x 38.5
39 / 6
0.13...6

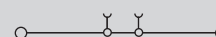

IEC 60947-7-1		Ex e II		II 2 G D	
IEC	UL	CSA	EN 60079-7		
500	300	300	440		
32	10	10	27		
4	AWG 26...12	AWG 26...10	4		
6 / 3					
A4 / V-0					

Rated connection		Further connection
0.5...6 / 1.5...6		
0.5...4 / 0.5...4		
0.5...1.0 Nm (M 3)		
11 / 0.6 x 3.5 mm		
0.5...1.5		
0.5...1.5 / 0.5...1.5		

Type	Qty	Order No.
WDU 4N	100	1042600000
WDU 4N BL	100	1042680000

Type	current	Qty	Order No.
ZQV 4N/2 GE	32 A	60	1758250000
ZQV 4N/3 GE	32 A	60	1762630000
ZQV 4N/4 GE	32 A	60	1762620000
ZQV 4N/10 GE	32 A	20	1758260000
ZQV 4N/20 GE	32 A	20	1909020000
Width			
WAP WDU2.5N/4N	1.5 mm	50	1060000000
WAP WDU2.5N/4N BL	1.5 mm	50	1060080000
EW 35	8.5 mm	50	0383560000
WTA 1 WDU1.5	5 mm	25	1632290000
WTA 1/ZA WDU1.5	5 mm	25	1632300000
WAD 4 GE BED	4 mm	50	1072000000
WAD 4 WS	4 mm	50	1072100000
DEK 5/6 / WS 12/6			

Feed-through terminals

Identical profiles from 2.5 to 10 mm² with uniform end and partition plates. An unsurpassed combination of many advantages!

Their small size compared to the respective rated cross-section makes the modular terminals with the compact design very popular.

In hazardous area applications, the installation instructions and the rated data specifications for accessories given in the technical appendix must be followed.

Width/Length/height with TS35x7.5	mm
max. current / max. cond. cross-section	A/mm ²
Max. clamping range	mm ²



Technical data

Rated data	
Rated voltage	V
Rated current	A
Rated cross-section	mm ²
Rated impulse voltage / Pollution severity	kV/-
Gauge to IEC 60947-1 / UL94 Flammability class	Approvals
Clamped conductors (H05V/H07V)	
solid / stranded	mm ²
flexible / Stranded wire with end ferrules	mm ²
Tightening torque range (clamping screw)	
Stripping length / Blade size	mm/-
2 conductors with same cross-section (H05V/H07V)	
solid / stranded	mm ²
flexible / Stranded wire with end ferrules	mm ²
Note	

Ordering data

Version	
	Dark beige Wemid
	Blue Wemid
Note	

Accessories

Screwable cross-connection	
	2-pole
	3-pole
	4-pole
	10-pole
End plate / partition	
	Dark beige Wemid
	Blue Wemid
	Dark beige Wemid
	Blue Wemid
End bracket	
	Dark beige Wemid
Testing / Checking	
	Standard
Cover	
	With lightning flash symbol
	blank



Marking systems	(see assortment in catalogue 7)
	Marking tags
For detailed information on other accessories and applications, refer to the „Accessories“ section	

WDU 6

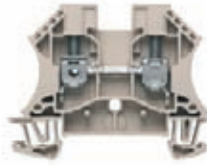
6 mm²

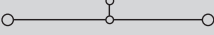

7.9 x 60 x 47	
57 / 10	
0.08...10	

IEC 60947-7-1				Ex e ll  II 2 G D			
IEC	UL	CSA	EN 60079-7				
800	600	600	550				
41	50	50	36				
6	AWG 22...8	AWG 22...8	6				
				8 / 3			
				A5 / V-0			
 KEMA 98ATEX1683 U							
Rated connection		Further connection					
0.5...10 / 1.5...10							
0.5...10 / 0.5...6							
0.8...1.6 Nm (M 3.5)							
12 / 4.0 x 0.8 mm							
0.5...2.5							
0.5...2.5 / 0.5...2.5							
Note max. current of terminal (57 A) when using WQV! Conductor connection H07V...10 and AWG 8 tighten with 1.4-1.6 Nm.							

Type	Qty	Order No.
WDU 6	100	1020200000
WDU 6 BL	100	1020280000
For colours available see section W-series accessories „Specific functions“		

Type	current	Qty	Order No.
WQV 6/2	57 A	50	1052360000
WQV 6/3	57 A	50	1054760000
WQV 6/4	57 A	50	1054860000
WQV 6/10	57 A	20	1052260000
Width			
WAP 2.5-10	1.5 mm	50	1050000000
WAP 2.5-10 BL	1.5 mm	50	1050080000
WAP 16+35 WTW 2.5-10	1.5 mm	20	1050100000
WAP 16+35 WTW 2.5-10 BL	1.5 mm	20	1050180000
Width			
WEW 35/2	8 mm	100	1061200000
WTA 5/1	5 mm	25	1051260000
WAD 8 M. BL.	8 mm	50	1053560000
WAD 8 NEUTRAL	8 mm	50	1056160000



Marking systems	(see assortment in catalogue 7)
	DEK 5/8 / WS 12/6,5
Socket and test plug, see section „W Series accessories“, shielding rail LS 2.8 1056400000.	

WDU 10

10 mm²

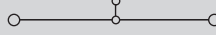

9.9 x 60 x 47	
76 / 16	
1.31...16	

IEC 60947-7-1				Ex e ll  II 2 G D			
IEC	UL	CSA	EN 60079-7				
1000	600	600	550				
57	65	65	50				
10	AWG 18...6	AWG 16...6	10				
				8 / 3			
				B6 / V-0			
 KEMA 98ATEX1683 U							
Rated connection		Further connection					
1.5...16 / 1.5...16							
1...6 / 1.5...16							
1.2...2.4 Nm (M 4)							
12 / 1.0 x 5.5 mm							
1...6							
1...6 / 1...6							
Note max. current of terminal (76 A) when using WQV! AWG 6/7 and H07V-R16 tightened with 2.4 Nm.							

Type	Qty	Order No.
WDU 10	50	1020300000
WDU 10 BL	50	1020380000
For colours available see section W-series accessories „Specific functions“		

Type	current	Qty	Order No.
WQV 10/2	57 A	50	1052560000
WQV 10/3	57 A	50	1054960000
WQV 10/4	57 A	50	1055060000
WQV 10/10	57 A	20	1052460000
Width			
WAP 2.5-10	1.5 mm	50	1050000000
WAP 2.5-10 BL	1.5 mm	50	1050080000
WAP 16+35 WTW 2.5-10	1.5 mm	20	1050100000
WAP 16+35 WTW 2.5-10 BL	1.5 mm	20	1050180000
Width			
WEW 35/2	8 mm	100	1061200000
WTA 5/1	5 mm	25	1051260000
WAD 8 M. BL.	8 mm	50	1053560000
WAD 8 NEUTRAL	8 mm	50	1056160000

Marking systems	(see assortment in catalogue 7)
	DEK 5/5 / WS 12/6,5
Socket and test plug, see section „W Series accessories“, shielding rail LS 2.8 1056400000.	

WDU 10/ZR

10 mm²

Supplementary connection, right (4 mm²)



9.9 x 70 x 49.5
76 / 16
1.31...16



IEC 60947-7-1

IEC	UL	CSA
800	600	600
57	65	65
10	AWG 16...6	AWG 16...6
8 / 3		
B6 / A4 / V-0		

Rated connection		Further connection
1.5...16 / 1.5...16	0.5...6 / 1.5...4	
1...6 / 1.5...16	0.5...4 / 0.5...4	
1.2...2.4 Nm (M 4)		
12 / 0.6 x 3.5 mm	9 / 0.6 x 3.5 mm	
1...1.5		
1...6 / 1...6		
Note max. current of terminal (76 A) when using WQV. AWG 6/7 and H07V-R16 tighten with 2.4 Nm. ZR connection top right A 4.		

Type	Qty	Order No.
WDU 10/ZR	50	1042400000
WDU 10/ZR BL	50	1042480000
Rated data relates to 10mm ² connection		

Type	current	Qty	Order No.
WQV 10/2	57 A	50	1052560000
WQV 10/3	57 A	50	1054960000
WQV 10/4	57 A	50	1055060000
WQV 10/10	57 A	20	1052460000
Width			
WAP 16+35 WTW 2.5-10	1.5 mm	20	1050100000
WAP 16+35 WTW 2.5-10 BL	1.5 mm	20	1050180000
WEW 35/2	8 mm	100	1061200000
WTA 5/1	5 mm	25	1051260000

DEK 5/5 / WS 12/6,5
Socket and test plug, see section „W-series accessories“

WDU 16

16 mm²

With peg for higher connection stability

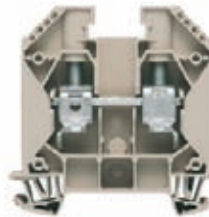

11.9 x 60 x 63
101 / 25
1.5...25

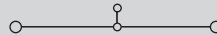

IEC 60947-7-1

IEC	UL	CSA	EN 60079-7
1000	600	600	690
76	85	85	66
16	AWG 18...4	AWG 14...6	16
8 / 3			
B7 / V-0			

Rated connection		Further connection
1.5...16 / 1.5...25		
1.5...25 / 1.5...16		
3.0...4.0 Nm (M 5)		
16 / 1.0 x 5.5 mm		
1.5...6		
1.5...6 / 1.5...6		
Conductor connection H07V...16 and AWG 6 with tightening torque of 2.0-2.4 Nm.		

Type	Qty	Order No.
WDU 16/ZA	50	1028900000
WDU 16/ZA BL	50	1028980000
Order No. 1020400000 and 1020480000 (blue) versions without pegs (50 pcs.)		

Type	current	Qty	Order No.
WQV 16/2	76 A	50	1053260000
WQV 16/3	76 A	50	1055160000
WQV 16/4	76 A	50	1055260000
WQV 16/10	76 A	10	1053360000
Width			
WAP 16+35 WTW 2.5-10	1.5 mm	20	1050100000
WAP 16+35 WTW 2.5-10 BL	1.5 mm	20	1050180000
WEW 35/1	12 mm	50	1059000000
WAD 12 M. BL.	12 mm	50	1055960000
WAD 12 NEUTRAL	12 mm	50	1056260000

DEK 5/5 / WS 12/6,5
Socket and test plug, see section „W-series accessories“

WDU 16N

16 mm²

Suitable for power distribution
Compact design



12 x 60 x 47
101 / 25
1.5...25

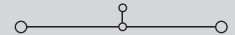

IEC 60947-7-1

IEC	UL	CSA
690	300	300
76	70	70
16	AWG 14...6	AWG 14...6
8 / 3		
B7 / V-0		

Rated connection		Further connection
1.5...16 / 1.5...25		
1.5...16 / 1.5...16		
1.2...2.4 Nm (M 4)		
12 / 1.0 x 5.5 mm		
1.5...4		
1.5...4 / 1.5...4		
AWG 6/7 and H07V-R25 with 1.5 Nm tightening torque		

Type	Qty	Order No.
WDU 16N	50	1036100000
WDU 16N BL	50	1036180000

Type	current	Qty	Order No.
WQV 16N/2	101 A	50	1636560000
WQV 16N/3	76 A	50	1636570000
WQV 16N/4	76 A	50	1636580000
Width			
WTW EN	3 mm	20	1058800000
WEW 35/2	8 mm	100	1061200000
WTA 2 WDU.2.5-10	5 mm	25	1632320000
WAD 12N GE BED	12 mm	50	1073200000
WAD 12N WS	12 mm	50	1073290000

DEK 5/5 / WS 12/6,5
Socket and test plug, see section „W-series accessories“

Feed-through terminals

Identical profiles from 2.5 to 10 mm² with uniform end and partition plates. An unsurpassed combination of many advantages!

Their small size compared to the respective rated cross-section makes the modular terminals with the compact design very popular.

In hazardous area applications, the installation instructions and the rated data specifications for accessories given in the technical appendix must be followed.

Width/Length/height with TS35x7.5	mm
max. current / max. cond. cross-section	A/mm ²
Max. clamping range	mm ²



Technical data

Rated data	
Rated voltage	V
Rated current	A
Rated cross-section	mm ²
Rated impulse voltage / Pollution severity	kV/-
Gauge to IEC 60947-1 / UL94 Flammability class	
Approvals	
Clamped conductors (H05V/H07V)	
solid / stranded	mm ²
flexible / Stranded wire with end ferrules	mm ²
Tightening torque range (clamping screw)	
Stripping length / Blade size	mm/-
2 conductors with same cross-section (H05V/H07V)	
solid / stranded	mm ²
flexible / Stranded wire with end ferrules	mm ²
Note	

Ordering data

Version	
	Dark beige Wemid
	Blue Wemid
Note	

Accessories

Screwable cross-connection	
	2-pole
	3-pole
	4-pole
	10-pole
End plate / partition	
	Dark beige Wemid
	Blue Wemid
	Dark beige Wemid
	Blue Wemid
End bracket	
	Dark beige Wemid
Testing / Checking	
	Standard
Cover	
	With lightning flash symbol
	blank



Marking systems	(see assortment in catalogue 7)
	Marking tags
For detailed information on other accessories and applications, refer to the „Accessories“ section	

WDU 35

35 mm²

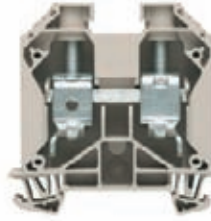
Clamping screw / spigot for good connection stability



16 x 60 x 63	
150 / 50	
2.5...50	

IEC 60947-7-1				Ex e ll  II 2 G D			
IEC	UL	CSA	EN 60079-7	IEC	UL	CSA	EN 60079-7
1000	1000	600	690	1000	1000	600	690
125	150	120	109	125	150	120	109
35	AWG 12...1	AWG 12...2	35	35	AWG 12...1	AWG 12...2	35
				8 / 3			
				B8 / V-0			
				KEMA 98ATEX1683 U			
Rated connection		Further connection		Rated connection		Further connection	
2.5...16 / 2.5...50		2.5...35 / 2.5...35		2.5...16 / 2.5...50		2.5...35 / 2.5...35	
4.0...5.0 Nm (M 6)		18 / 6.5 x 1.2 mm		4.0...6.0 Nm (M 6)		18 / S6 (DIN 6911)	
2.5...10 / 16...16		2.5...16 / 2.5...16		2.5...10 / 16...16		2.5...16 / 2.5...16	
The tightening torque is 4.5 Nm for 16 - 50 mm ² and AWG 6 - 2/7 stranded conductors. Copper straps can be used; possible connections: 3 to 9 layers 9 x 0.8 mm.							

Type	Qty	Order No.
WDU 35/ZA	40	1028800000
WDU 35/ZA BL	40	1028880000
Order No. 1020500000 and 1020580000 (blue) versions without pegs (40 pcs.)		

Type	current	Qty	Order No.
WQV 35/2	135 A	50	1053060000
WQV 35/3	112 A	50	1055360000
WQV 35/4	112 A	50	1055460000
WQV 35/10	112 A	10	1053160000
Width			
WAP 16+35 WTW 2.5-10	1.5 mm	20	1050100000
WAP 16+35 WTW 2.5-10 BL	1.5 mm	20	1050180000
WEW 35/1	12 mm	50	1059000000
WAD 12 M. BL.	12 mm	50	1055960000
WAD 12 NEUTRAL	12 mm	50	1056260000



Marking systems	(see assortment in catalogue 7)
	DEK 5/5 / WS 12/6,5
Socket and test plug, see section „W-series accessories“	

WDU 35 IK

35 mm²

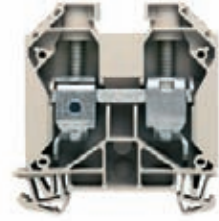
Hexagonal socket / spigot for good connection stability



16 x 60 x 63	
150 / 50	
2.5...50	

IEC 60947-7-1				Ex e ll  II 2 G D			
IEC	UL	CSA	EN 60079-7	IEC	UL	CSA	EN 60079-7
1000	1000	600	690	1000	1000	600	690
125	150	120	109	125	150	120	109
35	AWG 12...1	AWG 12...2	35	35	AWG 12...1	AWG 12...2	35
				8 / 3			
				B8 / V-0			
				KEMA 98ATEX1683 U			
Rated connection		Further connection		Rated connection		Further connection	
2.5...16 / 2.5...50		2.5...35 / 2.5...35		2.5...16 / 2.5...50		2.5...35 / 2.5...35	
4.0...6.0 Nm (M 6)		18 / S6 (DIN 6911)		4.0...6.0 Nm (M 6)		18 / S6 (DIN 6911)	
2.5...10 / 16...16		2.5...16 / 2.5...16		2.5...10 / 16...16		2.5...16 / 2.5...16	
The tightening torque is 4.5 Nm for 16 - 50 mm ² and AWG 6 - 2/7 stranded conductors. Copper straps can be used; possible connections: 3 to 9 layers 9 x 0.8 mm.							

Type	Qty	Order No.
WDU 35/IK/ZA	25	1029000000
Order No. 1020600000 and 1020680000 (blue) versions without pegs (25 pcs.)		

Type	current	Qty	Order No.
WQV 35/2	135 A	50	1053060000
WQV 35/3	112 A	50	1055360000
WQV 35/4	112 A	50	1055460000
WQV 35/10	112 A	10	1053160000
Width			
WAP 16+35 WTW 2.5-10	1.5 mm	20	1050100000
WAP 16+35 WTW 2.5-10 BL	1.5 mm	20	1050180000
WEW 35/1	12 mm	50	1059000000
WAD 12 M. BL.	12 mm	50	1055960000
WAD 12 NEUTRAL	12 mm	50	1056260000

Marking systems	(see assortment in catalogue 7)
	WS 12/6,5 / DEK 5/5
Socket and test plug, see section „W-series accessories“	

WDU 35N

35 mm²

Suitable for power distribution
Compact design



16 x 66 x 51
150 / 50
2.5...50

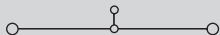

IEC 60947-7-1

IEC	UL	CSA
500	300	300
125	150	10
35	AWG 12...1	AWG 12...2
	6 / 3	
	B8 / V-0	

Rated connection	Further connection
2.5...16 / 2.5...50	
2.5...35 / 2.5...35	
4.0...5.0 Nm (M 6)	
18 / 6.5 x 1.2 mm	
2.5...6	
2.5...6 / 2.5...6	
The tightening torque is 4.5 Nm for 16 - 50 mm ² and AWG 6 - 2/7 stranded conductors. Copper straps can be used; possible connections: 3 to 9 layers 9 x 0.8 mm.	

Type	Qty	Order No.
WDU 35N	20	1040400000
WDU 35N BL	20	1040480000

Type	current	Qty	Order No.
WQV 35N/2	135 A	20	1079200000
WQV 35N/3	101 A	20	1079300000
WQV 35N/4	101 A	20	1079400000
Width			
WTW EN	3 mm	20	1058800000
Width			
WEW 35/2	8 mm	100	1061200000
Width			
WAD 16N GE BED	16 mm	50	1083600000
WAD 16N WS	16 mm	50	1083500000

DEK 5/5 / WS 12/6,5

WDU 50N

50 mm²

Compact design



18.5 x 70 x 70
192 / 70
10...70

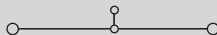

IEC 60947-7-1

IEC	UL	CSA	EN 60079-7
1000	600	600	690
150	150	150	126
50	AWG 10...1/0	AWG 8...1/0	50
	8 / 3		
	B10 / V-0		

Rated connection	Further connection
10...16 / 10...70	
10...50 / 10...50	
3.5...6.0 Nm (M 6)	
24 / S4 (DIN 6911)	
/ 6...16	
6...16 / 6...16	
Copper straps can be used, possible connections: see online catalogue.	

Type	Qty	Order No.
WDU 50N	10	1820840000
WDU 50N BL	10	1820850000

Type	current	Qty	Order No.
WQV 50N/2	150 A	5	1834060000
WQV 50N/3	150 A	5	1834070000
WQV 50N/4	150 A	5	1834080000
Width			
WEW 35/1	12 mm	50	1059000000
Width			
WAD 20 GE WSD	20.5 mm	10	9512260000
WAD 20 WS	20.5 mm	10	9512270000

DEK 5/5 / WS 12/6,5

Auxiliary connection for the additional conductor „WZAD 50N“, order no. 1872720000 (up to 10 mm², 41 A)

WDU 70N

70 mm²

Compact design



20.5 x 75 x 86
232 / 95
10...95

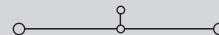

IEC 60947-7-1

IEC	UL	CSA	EN 60079-7
1000	600	600	690
192	175	205	167
70	AWG 6...3/0	AWG 8...2/0	70
	8 / 3		
	B11 / V-0		

Rated connection	Further connection
10...16 / 10...95	
10...70 / 10...70	
6.0...10 Nm (M 8)	
22 / S6 (DIN 6911)	
6...16 / 10...	
10...25 / 6...25	
Copper straps can be used, possible connections: see online catalogue.	

Type	Qty	Order No.
WDU 70N/35	10	9512190000
WDU 70N/35 BL	10	9512420000

Type	current	Qty	Order No.
WQV 70N/2	192 A	5	9512240000
WQV 70N/3	192 A	5	9512250000
WQV 70N/4	192 A	5	9531290000
Width			
WEW 35/1	12 mm	50	1059000000
Width			
WAD 20 GE WSD	20.5 mm	10	9512260000
WAD 20 WS	20.5 mm	10	9512270000

DEK 5/5 / WS 12/6,5

Auxiliary connection for the additional conductor „WZAD 70N“, order no. 1964830000 (up to 10 mm², 41 A)

Feed-through terminals

Identical profiles from 2.5 to 10 mm² with uniform end and partition plates. An unsurpassed combination of many advantages!

Their small size compared to the respective rated cross-section makes the modular terminals with the compact design very popular.

In hazardous area applications, the installation instructions and the rated data specifications for accessories given in the technical appendix must be followed.

Width/Length/height with TS35x7.5	mm
max. current / max. cond. cross-section	A/mm ²
Max. clamping range	mm ²



Technical data

Rated data	
Rated voltage	V
Rated current	A
Rated cross-section	mm ²
Rated impulse voltage / Pollution severity	kV/-
Gauge to IEC 60947-1 / UL94 Flammability class	
Approvals	
Clamped conductors (H05V/H07V)	
solid / stranded	mm ²
flexible / Stranded wire with end ferrules	mm ²
Tightening torque range (clamping screw)	
Stripping length / Blade size	mm/-
2 conductors with same cross-section (H05V/H07V)	
solid / stranded	mm ²
flexible / Stranded wire with end ferrules	mm ²
Note	

Ordering data

Version	
	Dark beige Wemid
	Blue Wemid
Note	

Accessories

Screwable cross-connection	
	2-pole
	3-pole
	4-pole
	10-pole
End plate / partition	
	Dark beige Wemid
	Blue Wemid
	Dark beige Wemid
	Blue Wemid
End bracket	
	Dark beige Wemid
Testing / Checking	
	Standard
Cover	
	With lightning flash symbol
	blank

Marking systems	
	(see assortment in catalogue 7)
	Marking tags
For detailed information on other accessories and applications, refer to the „Accessories“ section	



WDU 95N/120N

120 mm²

Compact design



27 x 91 x 90	
290 / 150	
16...150	

IEC 60947-7-1				Ex e ll  II 2 G D			
IEC	UL	CSA	EN 60079-7	IEC	UL	CSA	EN 60079-7
1000	1000	1000	880	1000	600	600	1100
269	228	220	243	415	380	380	300
120	AWG 4...kcmil 250	AWG 4...4/0	120	240	AWG 00.500MCM	AWG 00.500MCM	240
				8 / 3			
				B13 / V-0			
				KEMA 98ATEX1683 U			
Rated connection		Further connection		Rated connection		Further connection	
16...16 / 16...150				/ 70...240			
16...120 / 16...95				70...240 / 70...185			
12...20 Nm (M 10)				12...20 Nm (M 10)			
27 / S6 (DIN 6911)				40 / S8 (DIN 6911)			
10...16 / 10...35		mm ²		/ 35...95			
16...35 / 10...35		mm ²		50...95 / 35...50			
Copper band strips can be used, refer to online catalogue When connecting the AWG conductor kcmil 250, the stripping length is 30 mm and the tightening torque is 16 Nm							

Type	Qty	Order No.
WDU 95N/120N	5	1820550000
WDU 95N/120N BL	5	1820560000

Type	current	Qty	Order No.
WQV 95N/120N-2	269 A	5	1826890000
WQV 95N/120N-3	269 A	5	1826900000
WQV 95N/120N-4	269 A	5	1826910000
Width			
WEW 35/1	12 mm	50	1059000000
WAD 20 GE WSD	20.5 mm	10	9512260000
WAD 20 WS	20.5 mm	10	9512270000

Marking systems	
	(see assortment in catalogue 7)
	Marking tags
For detailed information on other accessories and applications, refer to the „Accessories“ section	



DEK 5/5 / WS 12/6,5
Auxiliary connection for the additional conductor „WZAD 95N/120N“, order no. 1859580000 (up to 10 mm², 41 A)

WDU 240

240 mm²

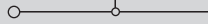

36 x 100 x 131.5	
415 / 240	
70...240	

IEC 60947-7-1				Ex e ll  II 2 G D			
IEC	UL	CSA	EN 60079-7	IEC	UL	CSA	EN 60079-7
1000	600	600	1100	1000	600	600	1100
415	380	380	300	415	380	380	300
240	AWG 00.500MCM	AWG 00.500MCM	240	240	AWG 00.500MCM	AWG 00.500MCM	240
				8 / 3			
				B15 / V-0			
				KEMA 01ATEX2186 U			
Rated connection		Further connection		Rated connection		Further connection	
/ 70...240				/ 70...240			
70...240 / 70...185				70...240 / 70...185			
12...20 Nm (M 10)				12...20 Nm (M 10)			
40 / S8 (DIN 6911)				40 / S8 (DIN 6911)			
/ 35...95		mm ²		/ 35...95			
50...95 / 35...50		mm ²		50...95 / 35...50			
Copper straps can be used, possible connections: see online catalogue.							

Type	Qty	Order No.
WDU 240	2	1802780000
WDU 240 BL	2	1822210000

Type	current	Qty	Order No.
WQB 240/2	320 A	5	1802790000
WQB 240/3	320 A	5	1802800000
Width			
WEW 35/1	12 mm	50	1059000000

Marking systems	
	(see assortment in catalogue 7)
	Marking tags
For detailed information on other accessories and applications, refer to the „Accessories“ section	

DEK 5/5 / WS 12/6,5
Auxiliary connection for the additional conductor „WZAD 240“, order no. 180281000 (up to 10 mm², 57 A) ELPF insertion profile, for ribbon cable, order no. 1824680000

Large conductor cross-sections do not require a great force to insert them into the clamping point, but instead can be easily and quickly placed in the modular terminal.

Every type of terminal is available in both single and block forms. All blocks are screwed permanently together and therefore provide additional torsional rigidity.

Direct mounting is possible thanks to the elongated holes on the underside of the terminal.

In hazardous area applications, the installation instructions and the rated data specifications for accessories given in the technical appendix must be followed.

Width/Length/height with TS35x7.5	mm
max. current / max. cond. cross-section	A/mm ²
Max. clamping range	mm ²

Technical data

Rated data	
Rated voltage	V
Rated current	A
Rated cross-section	mm ²
Rated impulse voltage / Pollution severity	kV/-
Gauge to IEC 60947-1 / UL94 Flammability class	
Approvals	
Clamped conductors (H05V/H07V)	
solid / stranded	mm ²
flexible / Stranded wire with end ferrules	mm ²
Tightening torque range (clamping screw)	
Stripping length / Blade size	mm/-
2 conductors with same cross-section (H05V/H07V)	
solid / stranded	mm ²
flexible / Stranded wire with end ferrules	mm ²

Note

Ordering data

Version	
	Dark beige Wemid
	Blue Wemid

Note

Accessories

Screwable cross-connection	
	2-pole
	3-pole

End bracket	
	Dark beige Wemid

Cover	
	With lightning flash symbol
	blank

Marking systems	
	(see assortment in catalogue 7)
	Marking tags

For detailed information on other accessories and applications, refer to the „Accessories“ section

Technical drawing

WDU 70/95

95 mm²

Conductor can be inserted from above / leaf spring

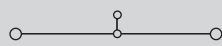

27 x 132 x 108	
232 / 120	
13.3...120	

IEC 60947-7-1 Ex e ll  II 2 G D

IEC	UL	CSA	EN 60079-7
1000	600	600	690
232	175	205	202
95	AWG 6...2/0	AWG 6...2/0	95
8 / 3			
B12 / V-0			

 KEMA 98ATEX1686 U

Rated connection	Further connection
16...16 / 16...120	
16...95 / 16...95	
6.0...12 Nm (M 8)	
30 / S6 (DIN 6911)	
16...16 / 16...35	mm ²
16...35 / 16...35	mm ²

WDU 120/150

150 mm²

Conductor can be inserted from above / leaf spring



32 x 132 x 118	
309 / 150	
33.63...150	

IEC 60947-7-1 Ex e ll  II 2 G D

IEC	UL	CSA	EN 60079-7
1000	600	600	1100
309	225	285	234
150	AWG 2...kamil 250	AWG 2...kamil 250	150
8 / 3			
B13 / V-0			

 KEMA 98ATEX1686 U

Rated connection	Further connection
16...16 / 35...150	
35...70 / 35...95	
10...20 Nm (M 10)	
35 / S6 (DIN 6911)	
/ 35...70	
35...70 / 35...70	

Type	Qty	Order No.
WDU 120/150	10	1024500000
WDU 120/150 BL	10	1024580000

Type	Qty	Order No.
WDU 70/95	10	1024600000
WDU 70/95 BL	10	1024680000

Type	current	Qty	Order No.
WQV 70/95/2	192 A	5	1063500000
WQV 70/95/3	232 A	5	1063600000

Width			
WEW 35/1	12 mm	50	1059000000

Width			
WAD 27 M. BL.	27 mm	10	1062860000
WAD 27 NEUTRAL	27 mm	10	1062960000

DEK 5/5 / WS 12/6,5
Auxiliary connection for the additional conductor „WZAD 70“, order no. 1066000000 (up to 4 mm², 32 A)

Type	current	Qty	Order No.
WQV 120/2	269 A	5	1063300000
WQV 120/3	269 A	5	1063400000

Width			
WEW 35/1	12 mm	50	1059000000

Width			
WAD 27 M. BL.	27 mm	10	1062860000
WAD 27 NEUTRAL	27 mm	10	1062960000

DEK 5/5 / WS 12/6,5
Auxiliary connection for the additional conductor „WZAD 120“, order no. 1066100000 (up to 4 mm², 32 A)

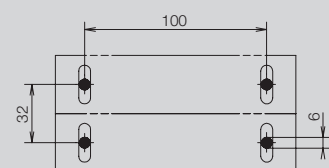
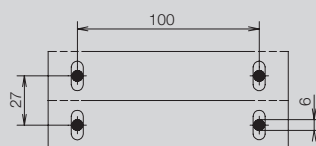

Double level terminals

Identical profiles from 2.5 to 10 mm² with uniform end and partition plates. An unsurpassed combination of many advantages!

Their small size compared to the respective rated cross-section makes the modular terminals with the compact design very popular.

In hazardous area applications, the installation instructions and the rated data specifications for accessories given in the technical appendix must be followed.

Width/Length/height with TS35x7.5	mm
max. current / max. cond. cross-section	A/mm ²
Max. clamping range	mm ²



Technical data

Rated data	
Rated voltage	V
Rated current	A
Rated cross-section	mm ²
Rated impulse voltage / Pollution severity	kV/-
Gauge to IEC 60947-1 / UL94 Flammability class	Approvals
Clamped conductors (H05V/H07V)	
solid / stranded	mm ²
flexible / Stranded wire with end ferrules	mm ²
Tightening torque range (clamping screw)	
Stripping length / Blade size	mm/-
2 conductors with same cross-section (H05V/H07V)	
solid / stranded	mm ²
flexible / Stranded wire with end ferrules	mm ²
Note	

Ordering data

Version	
	Dark beige Wemid
	Blue Wemid
Note	

Accessories

Pluggable cross-connection	
	2-pole
	3-pole
	4-pole
	10-pole
	20-/24-pole
Screwable cross-connection	
	2-pole
	3-pole
	4-pole
	10-pole
End plate / partition	
	Dark beige Wemid
	Blue Wemid
	Dark beige Wemid
End bracket	
	Dark beige Wemid
Cover	
	With lightning flash symbol
	blank
Marking systems	
	(see assortment in catalogue 7)
	Marking tags
For detailed information on other accessories and applications, refer to the „Accessories“ section	

WDK 2.5 ZQV

2.5 mm²

Plug-in cross-connection



5.1 x 65.4 x 63	
32 / 4	
0.05...4	

IEC 60947-7-1			
IEC	UL	CSA	
400	300	300	
24	20	25	
2.5	AWG 30...12	AWG 26...12	
6 / 3			
A3 / V-0			
KEMA 98ATEX1685 U			
Rated connection			
0.5...4 / 1.5...4			
0.5...4 / 0.5...2.5			
0.4...0.6 Nm (M 2.5)			
10 / 0.6 x 3.5 mm			
0.5...1.5			
0.5...1.5 / 0.5...1.5			
2.5 mm ² conductor with wire end ferrule plus plastic collar only with collar optimised for diameter (order No. 1333100000, 500 pcs)			

Type	Qty	Order No.
WDK 2.5 ZQV	100	1041100000
WDK 2.5 ZQV BL	100	1041180000
Rated voltage 400V when using cross-connection ZQV		
See section „W-series accessories“ for colours available.		

Type	current	Qty	Order No.
ZQV 2.5N/2 GE	24 A	60	1693800000
ZQV 2.5N/3 GE	24 A	60	1693810000
ZQV 2.5N/4 GE	24 A	60	1693820000
ZQV 2.5N/10 GE	24 A	20	1693880000
ZQV 2.5N/20 GE	24 A	20	1909000000
Width			
WAP WDK2.5	1.5 mm	20	1059100000
WAP WDK2.5 BL	1.5 mm	20	1059180000
WTW EN	3 mm	20	1058800000
WEW 35/2	8 mm	100	1061200000
WAD 4 GE BED	4 mm	50	1072000000
WAD 4 WS	4 mm	50	1072100000

DEK 5/5 / WS 8/5	Test plug and socket, see „W-Series Accessories“ section Note the 2.5 mm ² max. when using the WQB.
------------------	---

WDK 2.5

2.5 mm²

Screwable cross-connection

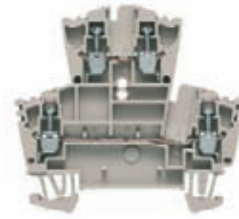

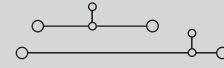
5.1 x 69 x 63	
32 / 4	
0.05...4	

IEC 60947-7-1				Ex e ll II 2 G D	
IEC	UL	CSA	EN 60079-7		
400	300	300	275		
24	20	10	21		
2.5	AWG 30...12	AWG 26...12	2.5		
6 / 3					
A3 / V-0					
KEMA 98ATEX1687 U					
Rated connection					
0.5...4 / 1.5...4					
0.5...4 / 0.5...2.5					
0.4...0.6 Nm (M 2.5)					
10 / 0.6 x 3.5 mm					
0.5...1.5					
0.5...1.5 / 0.5...1.5					
2.5 mm ² conductor with wire end ferrule plus plastic collar only with collar optimised for diameter (order No. 1333100000, 500 pcs)					

Type	Qty	Order No.
WDK 2.5	100	1021500000
WDK 2.5 BL	100	1021580000
For colours available see section „W-series accessories „Specific functions“		

Type	current	Qty	Order No.
WQV 2.5/2	32 A	50	1053660000
WQV 2.5/3	32 A	50	1053760000
WQV 2.5/4	32 A	50	1053860000
WQV 2.5/10	32 A	20	1054460000
Width			
WAP WDK2.5	1.5 mm	20	1059100000
WAP WDK2.5 BL	1.5 mm	20	1059180000
WTW EN	3 mm	20	1058800000
WEW 35/2	8 mm	100	1061200000
WAD 4 GE BED	4 mm	50	1072000000
WAD 4 WS	4 mm	50	1072100000

DEK 5/5 / WS 8/5	Test plug and socket, see „W-Series Accessories“ section Note the 2.5 mm ² max. when using the WQB.
------------------	---

WDK 2.5 V

2.5 mm²

Both levels at one potential



5.1 x 69.5 x 63
32 / 4
0.05...4

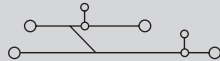

IEC 60947-7-1 Ex e II II 2 G D

IEC	UL	CSA	EN 60079-7
400	300	300	275
24	20	10	21
2.5	AWG 30...12	AWG 26...12	2.5
6 / 3			
A3 / V-0			

KEMA 98ATEX1687 U

Rated connection

0.5...4 / 1.5...4
0.5...4 / 0.5...2.5
0.4...0.6 Nm (M 2.5)
10 / 0.6 x 3.5 mm

0.5...1.5
0.5...1.5 / 0.5...1.5

2.5 mm² conductor with wire end ferrule plus plastic collar only with collar optimised for diameter (order No. 1333100000, 500 pcs)

Type	Qty	Order No.
WDK 2.5V	100	1022300000
WDK 2.5V BL	100	1022380000

For colours available see section W-series accessories „Specific functions“

Type	Qty	Order No.
current		
WQV 2.5/2	32 A 50	1053660000
WQV 2.5/3	32 A 50	1053760000
WQV 2.5/4	32 A 50	1053860000
WQV 2.5/10	32 A 20	1054460000
Width		
WAP WDK2.5	1.5 mm 20	1059100000
WAP WDK2.5 BL	1.5 mm 20	1059180000
WTW EN	3 mm 20	1058800000
Width		
WEW 35/2	8 mm 100	1061200000
Width		
WAD 4 GE BED	4 mm 50	1072000000
WAD 4 WS	4 mm 50	1072100000

DEK 5/5 / WS 8/5

Test plug and socket, see „W-Series Accessories“ section
Note the 2.5 mm² max. when using the WQB.

WDK 2.5 DU-PE

2.5 mm²

Lower level earthed on terminal rail



5.1 x 69.5 x 63
32 / 4
0.05...4

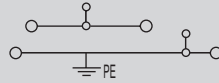

IEC 60947-7-1 (-7-2) Ex e II II 2 G D

IEC	UL	CSA	EN 60079-7
400	300	300	275
24	20	10	21
2.5	AWG 30...12	AWG 26...12	2.5
6 / 3			
A3 / V-0			

KEMA 98ATEX1687 U

Rated connection

0.5...4 / 1.5...4
0.5...4 / 0.5...2.5
0.4...0.6 Nm (M 2.5)
10 / 0.6 x 3.5 mm

0.5...1.5
0.5...1.5 / 0.5...1.5

2.5 mm² conductor with wire end ferrule plus plastic collar only with collar optimised for diameter (order No. 1333100000, 500 pcs)

Type	Qty	Order No.
WDK 2.5DU-PE	100	1036400000

Type	Qty	Order No.
current		
WQV 2.5/2	32 A 50	1053660000
WQV 2.5/3	32 A 50	1053760000
WQV 2.5/4	32 A 50	1053860000
WQV 2.5/10	32 A 20	1054460000
Width		
WAP WDK2.5	1.5 mm 20	1059100000
WAP WDK2.5 BL	1.5 mm 20	1059180000
WTW EN	3 mm 20	1058800000
Width		
WEW 35/2	8 mm 100	1061200000
Width		
WAD 4 GE BED	4 mm 50	1072000000
WAD 4 WS	4 mm 50	1072100000

DEK 5/5 / WS 8/5

Test plug and socket, see section „W-Series accessories“
Note the 2.5 mm² max. when using the WQB.

WDK 2.5 / 800 V

2.5 mm²

Rated voltage 800 V

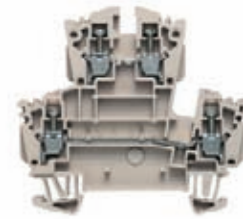

6.1 x 69 x 63
32 / 4
0.05...4

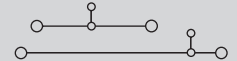

IEC 60947-7-1 Ex e II II 2 G D

IEC	UL	CSA	EN 60079-7
800			440
24		10	24
2.5			2.5
8 / 3			
A3 / V-0			

KEMA 98ATEX1685 U

Rated connection

0.5...4 / 1.5...4
0.5...4 / 0.5...2.5
0.4...0.6 Nm (M 2.5)
10 / 0.6 x 3.5 mm

0.5...1.5
0.5...1.5 / 0.5...1.5

Type	Qty	Order No.
WDK 2.5/800V	100	1029100000

Type	Qty	Order No.
current		
Q 2 AKZ4SS	20 A 50	0369000000
Q 3 AKZ4SS	20 A 50	0369100000
Q 4 AKZ4SS	20 A 50	0369200000
Q 10 AKZ4SS	20 A 20	0369300000
Width		
WAP WDK2.5	1.5 mm 20	1059100000
WAP WDK2.5 BL	1.5 mm 20	1059180000
WAP 16+35 WTW 2.5-10	1.5 mm 20	1050100000
Width		
WEW 35/2	8 mm 100	1061200000
Width		
WAD 4 GE BED	4 mm 50	1072000000
WAD 4 WS	4 mm 50	1072100000

DEK 5/6 / WS 8/5

Test plug and socket, see „W-Series Accessories“ section
Note the 2.5 mm² max. when using the WQB.

Double level terminals

Identical profiles from 2.5 to 10 mm² with uniform end and partition plates. An unsurpassed combination of many advantages!

Their small size compared to the respective rated cross-section makes the modular terminals with the compact design very popular.

In hazardous area applications, the installation instructions and the rated data specifications for accessories given in the technical appendix must be followed.

Width/Length/height with TS35x7.5	mm
max. current / max. cond. cross-section	A/mm ²
Max. clamping range	mm ²



Technical data

Rated data	
Rated voltage	V
Rated current	A
Rated cross-section	mm ²
Rated impulse voltage / Pollution severity	kV/-
Gauge to IEC 60947-1 / UL94 Flammability class	
Approvals	
Clamped conductors (H05V/H07V)	
solid / stranded	mm ²
flexible / Stranded wire with end ferrules	mm ²
Tightening torque range (clamping screw)	
Stripping length / Blade size	mm/-
2 conductors with same cross-section (H05V/H07V)	
solid / stranded	mm ²
flexible / Stranded wire with end ferrules	mm ²
Note	

Ordering data

Version	
	Dark beige Wemid
	Blue Wemid
Note	

Accessories

Pluggable cross-connection	
	2-pole
	3-pole
	4-pole
	10-pole
	20-/24-pole
Screwable cross-connection	
	2-pole
	3-pole
	4-pole
	10-pole
End plate / partition	
	Dark beige Wemid
	Blue Wemid
	Dark beige Wemid
End bracket	
	Dark beige Wemid
Cover	
	With lightning flash symbol
	blank
Marking systems	
	(see assortment in catalogue 7)
	Marking tags
For detailed information on other accessories and applications, refer to the „Accessories“ section	



WDK 2.5N

2.5 mm²

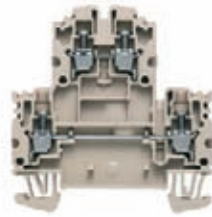
Plug-in cross-connection
Compact design



5.1 x 60.7 x 62.5	
28 / 4	
0.05...4	

IEC 60947-7-1				Ex e ll  II 2 G D			
IEC	UL	CSA	EN 60079-7	IEC	UL	CSA	EN 60079-7
800	600	300	550	800	600	300	550
24	20	20	21	24	20	20	21
2.5	AWG 30...12	AWG 26...12	2.5	2.5	AWG 30...12	AWG 26...12	2.5
				8 / 3			
				A3 / V-0			
				KEMA 00ATEX2061 U			
Rated connection							
0.5...4 / 1.5...4							
0.5...4 / 0.5...2.5							
0.4...0.6 Nm (M 2.5)							
8 / 0.6 x 3.5 mm							
0.5...1.5							
0.5...1.5 / 0.5...1.5							
When using the cross-connection ZQV 2.5N, the rated voltage is reduced to 400 V.							

Type	Qty	Order No.
WDK 2.5N	100	1041600000
WDK 2.5N BL	100	1041680000

Type	current	Qty	Order No.
ZQV 2.5N/2 GE	24 A	60	1693800000
ZQV 2.5N/3 GE	24 A	60	1693810000
ZQV 2.5N/4 GE	24 A	60	1693820000
ZQV 2.5N/10 GE	24 A	20	1693880000
ZQV 2.5N/20 GE	24 A	20	1909000000
Width			
WAP WDK2.5/4 N	1.5 mm	20	1084000000
WAP WDK2.5/4 N BL	1.5 mm	20	1084080000
WTW EN	3 mm	20	1058800000
Width			
WEW 35/2	8 mm	100	1061200000
Marking systems			
DEK 5/5 / WS 8/5			



WDK 2.5N V

2.5 mm²

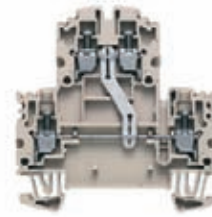
Both levels at one potential
Compact design



5.1 x 60.7 x 62.5	
28 / 4	
0.05...4	

IEC 60947-7-1				Ex e ll  II 2 G D			
IEC	UL	CSA	EN 60079-7	IEC	UL	CSA	EN 60079-7
800	600	300	550	800	600	300	550
24	20	20	21	24	20	20	21
2.5	AWG 30...12	AWG 26...12	2.5	2.5	AWG 30...12	AWG 26...12	2.5
				8 / 3			
				A3 / V-0			
				KEMA 00ATEX2061 U			
Rated connection							
0.5...4 / 1.5...4							
0.5...4 / 0.5...2.5							
0.4...0.6 Nm (M 2.5)							
8 / 0.6 x 3.5 mm							
0.5...1.5							
0.5...1.5 / 0.5...1.5							
When using the cross-connection ZQV, the rated voltage is reduced to 400 V.							

Type	Qty	Order No.
WDK 2.5N V	100	1041610000

Type	current	Qty	Order No.
ZQV 2.5N/2 GE	24 A	60	1693800000
ZQV 2.5N/3 GE	24 A	60	1693810000
ZQV 2.5N/4 GE	24 A	60	1693820000
ZQV 2.5N/10 GE	24 A	20	1693880000
ZQV 2.5N/20 GE	24 A	20	1909000000
Width			
WAP WDK2.5/4 N	1.5 mm	20	1084000000
WAP WDK2.5/4 N BL	1.5 mm	20	1084080000
WTW EN	3 mm	20	1058800000
Width			
WEW 35/2	8 mm	100	1061200000
Marking systems			
DEK 5/5 / WS 8/5			

WDK 2.5N DU-PE 2.5 mm²

Lower level earthed on terminal rail
Compact design



5.1 x 60.7 x 62.5
28 / 4
0.05...4

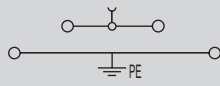

IEC 60947-7-1 (-7-2) Ex e II II 2 G D

IEC	UL	CSA	EN 60079-7
800	600	300	550
24	20	20	21
2.5	AWG 30...12	AWG 26...12	2.5
8 / 3			
A3 / V-0			

KEMA 00ATEX2061 U

Rated connection	
0.5...4 / 1.5...4	
0.5...4 / 0.5...2.5	
0.4...0.6 Nm (M 2.5)	
8 / 0.6 x 3.5 mm	
0.5...1.5	
0.5...1.5 / 0.5...1.5	
When using the cross-connection ZQV, the rated voltage is reduced to 400 V.	

Type	Qty	Order No.
WDK 2.5N DU-PE	100	1041650000

Type	current	Qty	Order No.
ZQV 2.5N/2 GE	24 A	60	1693800000
ZQV 2.5N/3 GE	24 A	60	1693810000
ZQV 2.5N/4 GE	24 A	60	1693820000
ZQV 2.5N/10 GE	24 A	20	1693880000
ZQV 2.5N/20 GE	24 A	20	1909000000

Width			
WAP WDK2.5/4 N	1.5 mm	20	1084000000
WAP WDK2.5/4 N BL	1.5 mm	20	1084080000
WTW EN	3 mm	20	1058800000
WEW 35/2	8 mm	100	1061200000

DEK 5/5 / WS 8/5

WDK 4N 4 mm²

Plug-in cross-connection
Compact design

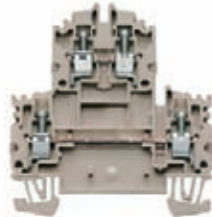

6.1 x 60 x 64.1
35 / 6
0.13...6

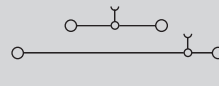

IEC 60947-7-1 Ex e II II 2 G D

IEC	UL	CSA	EN 60079-7
800	600	300	550
32	35	30	28
4	AWG 26...10	AWG 26...10	4
8 / 3			
A4 / V-0			

KEMA 00ATEX2061 U

Rated connection	
0.5...6 / 1.5...6	
0.5...4 / 0.5...4	
0.5...1.0 Nm (M 3)	
8 / 0.6 x 3.5 mm	
0.5...1.5	
0.5...1.5 / 0.5...1.5	
Rated voltage: 400V when using ZQV cross-connection 2 wire H07V-U1.5, tighten with 0.6 Nm.	

Type	Qty	Order No.
WDK 4N	100	1041900000
WDK 4N BL	100	1041980000

Type	current	Qty	Order No.
ZQV 4N/2 GE	32 A	60	1758250000
ZQV 4N/3 GE	32 A	60	1762630000
ZQV 4N/4 GE	32 A	60	1762620000
ZQV 4N/10 GE	32 A	20	1758260000
ZQV 4N/20 GE	32 A	20	1909020000

Width			
WAP WDK2.5/4 N	1.5 mm	20	1084000000
WAP WDK2.5/4 N BL	1.5 mm	20	1084080000
WTW EN	3 mm	20	1058800000
WEW 35/2	8 mm	100	1061200000

DEK 5/6 / WS 8/5

Test plug and socket, see „W-Series Accessories“ section
Note the 2.5 mm² max. when using the WQB.

WDK 4N V 4 mm²

Both levels at one potential
Compact design



6.1 x 60.7 x 64.1
35 / 6
0.13...6

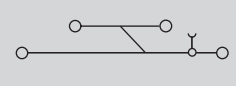

IEC 60947-7-1 Ex e II II 2 G D

IEC	UL	CSA	EN 60079-7
800	600	300	550
32	35	30	28
4	AWG 26...10	AWG 26...10	4
8 / 3			
A4 / V-0			

KEMA 00ATEX2061 U

Rated connection	
0.5...6 / 1.5...6	
0.5...4 / 0.5...4	
0.5...1.0 Nm (M 3)	
8 / 0.6 x 3.5 mm	
0.5...1.5	
0.5...1.5 / 0.5...1.5	
Rated voltage: 400V when using ZQV cross-connection 2 wire H07V-U1.5, tighten with 0.6 Nm.	

Type	Qty	Order No.
WDK 4N V	100	1041910000

Type	current	Qty	Order No.
ZQV 4N/2 GE	32 A	60	1758250000
ZQV 4N/3 GE	32 A	60	1762630000
ZQV 4N/4 GE	32 A	60	1762620000
ZQV 4N/10 GE	32 A	20	1758260000
ZQV 4N/20 GE	32 A	20	1909020000

Width			
WAP WDK2.5/4 N	1.5 mm	20	1084000000
WAP WDK2.5/4 N BL	1.5 mm	20	1084080000
WTW EN	3 mm	20	1058800000
WEW 35/2	8 mm	100	1061200000

DEK 5/6 / WS 8/5

Test plug and socket, see „W-Series Accessories“ section
Note the 2.5 mm² max. when using the WQB.

Double level terminals

Identical profiles from 2.5 to 10 mm² with uniform end and partition plates. An unsurpassed combination of many advantages!

Their small size compared to the respective rated cross-section makes the modular terminals with the compact design very popular.

In hazardous area applications, the installation instructions and the rated data specifications for accessories given in the technical appendix must be followed.

Width/Length/height with TS35x7.5	mm
max. current / max. cond. cross-section	A/mm ²
Max. clamping range	mm ²

Technical data

Rated data	
Rated voltage	V
Rated current	A
Rated cross-section	mm ²
Rated impulse voltage / Pollution severity	kV/-
Gauge to IEC 60947-1 / UL94 Flammability class	
Approvals	
Clamped conductors (H05V/H07V)	
solid / stranded	mm ²
flexible / Stranded wire with end ferrules	mm ²
Tightening torque range (clamping screw)	
Stripping length / Blade size	mm/-
2 conductors with same cross-section (H05V/H07V)	
solid / stranded	mm ²
flexible / Stranded wire with end ferrules	mm ²



Note

Ordering data

Version	
	Dark beige Wemid
	Blue Wemid

Note

Accessories

Pluggable cross-connection	
	2-pole
	3-pole
	4-pole
	10-pole
	20-/24-pole
Screwable cross-connection	
	2-pole
	3-pole
	4-pole
	10-pole
End plate / partition	
	Dark beige Wemid
	Blue Wemid
	Dark beige Wemid
End bracket	
	Dark beige Wemid
Cover	
	With lightning flash symbol
	blank

Marking systems	(see assortment in catalogue 7)
	Marking tags

For detailed information on other accessories and applications, refer to the „Accessories“ section

WDK 4N DU-PE

4 mm²

Lower level earthed on terminal rail
Compact design



6.1 x 60.7 x 64.1

35 / 6

0.13...6

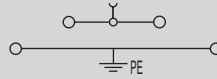

IEC 60947-7-1 (-7-2)

Ex e ll  II 2 G D

IEC	UL	CSA	EN 60079-7
800	600	300	550
32	35	30	28
4	AWG 26...10	AWG 26...10	4
8 / 3			
A4 / V-0			

 KEMA 00ATEX2061 U

Rated connection

0.5...6 / 1.5...6
0.5...4 / 0.5...4
0.5...1.0 Nm (M 3)
8 / 0.6 x 3.5 mm
0.5...1.5
0.5...1.5 / 0.5...1.5

Rated voltage is 400 V when using the ZQV cross-connector.
It is prohibited to connect two conductors via the PE connection!

Type	Qty	Order No.
WDK 4N DU-PE	100	1041950000

Type	current	Qty	Order No.
ZQV 4N/2 GE	32 A	60	1758250000
ZQV 4N/3 GE	32 A	60	1762630000
ZQV 4N/4 GE	32 A	60	1762620000
ZQV 4N/10 GE	32 A	20	1758260000
ZQV 4N/20 GE	32 A	20	1909020000

Width			
WAP WDK2.5/4 N	1.5 mm	20	1084000000
WAP WDK2.5/4 N BL	1.5 mm	20	1084080000
WTW EN	3 mm	20	1058800000
WEW 35/2	8 mm	100	1061200000

DEK 5/6 / WS 8/5

Test plug and socket, see „W-Series Accessories“ section
Note the 2.5 mm² max. when using the WQB.

Identical profiles from 2.5 to 10 mm² with uniform end and partition plates. An unsurpassed combination of many advantages! Their small size compared to the respective rated cross-section makes the modular terminals with the compact design very popular.

In hazardous area applications, the installation instructions and the rated data specifications for accessories given in the technical appendix must be followed.

Width/Length/height with TS35x7.5	mm
max. cond. cross-section	mm ²
Max. clamping range	mm ²

Technical data

Rated data	
Rated cross-section	mm ²
Rated voltage to adjacent terminal	V
Rated impulse withstand voltage to adjacent terminal	kV
Short-time withstand current	
Pollution severity	
Gauge to IEC 60947-1 / UL94 Flammability class	
Approvals	
Clamped conductors (H05V/H07V)	
solid / stranded	mm ²
flexible / Stranded wire with end ferrules	mm ²
Tightening torque range (clamping screw)	
Tightening torque range (fixing screw)	
Stripping length / Blade size	mm/-

Note

Ordering data

Version	Note
green/yellow Wemid	

Accessories

End plate / partition	End bracket	Screwdriver
Dark beige Wemid	Dark beige Wemid Dark beige Wemid	Standard

Marking systems (see assortment in catalogue 7)
Marking tags

For detailed information on other accessories and applications, refer to the „Accessories“ section

WPE 1.5/ZZ

1.5 mm²

Twin connection



5.1 x 60 x 47	
2.5	
0.13...2.5	

IEC 60947-7-2 Ex e ll II 2 G D

IEC	UL	CSA	EN 60079-7
1.5	AWG 26...14	AWG 26...14	1.5
800			
8			
	180 A (1,5 mm ²)		
	3		
	A1 / V-0		

Rated connection		Further connection	
0.5...2.5 / 1.5...2.5			
0.5...1.5 / 0.5...1.5			
0.4...0.6 Nm (M 2.5)			
0.4...0.6 Nm			
7 / 0.6 x 3.5 mm			

Type	Qty	Order No.
WPE 1.5/ZZ	100	1016500000

Type	Width	Qty	Order No.
WAP 2.5-10	1.5 mm	50	1050000000
WEW 35/2	8 mm	100	1061200000
SD 0.6x3.5x100		1	9008330000

DEK 5/5 / WS 12/5
Rail support for insulated installation of terminal rail „SH 2“ order no. 0494920000 (10 pcs)

WPE 2.5/1.5/ZR

2.5 mm²

Supplementary connection, right (1.5 mm²)



5.1 x 60 x 47	
4	
0.05...4	

IEC 60947-7-2 Ex e ll II 2 G D

IEC	UL	CSA	EN 60079-7
2.5	AWG 30...12	AWG 26...12	2.5
800			
8			
	300 A (2,5 mm ²)		
	3		
	A3 / V-0		

Rated connection		Further connection	
0.5...4 / 1.5...4		0.5...2.5 / 1.5...2.5	
0.5...4 / 0.5...2.5		0.5...1.5 / 0.5...2.5	
0.4...0.6 Nm (M 2.5)			
0.4...0.6 Nm (M 2.5)			
10 / 0.6 x 3.5 mm		7 / 0.6 x 3.5 mm	

2.5 mm² conductor with wire end ferrule plus plastic collar only with collar optimised for diameter (order No. 1333100000, 500 pcs)

Type	Qty	Order No.
WPE 2.5/1.5/ZR	100	1016400000

Type	Width	Qty	Order No.
WAP 2.5-10	1.5 mm	50	1050000000
WEW 35/2	8 mm	100	1061200000
SD 0.6x3.5x100		1	9008330000

DEK 5/5 / WS 12/5
Rail support for insulated installation of terminal rail „SH 2“ order no. 0494920000 (10 pcs)

Modular PE terminals

Identical profiles from 2.5 to 10 mm² with uniform end and partition plates. An unsurpassed combination of many advantages!

Their small size compared to the respective rated cross-section makes the modular terminals with the compact design very popular.

In hazardous area applications, the installation instructions and the rated data specifications for accessories given in the technical appendix must be followed.

Width/Length/height with TS35x7.5	mm
max. cond. cross-section	mm ²
Max. clamping range	mm ²

Technical data

Rated data	
Rated cross-section	mm ²
Rated voltage to adjacent terminal	V
Rated impulse withstand voltage to adjacent terminal	kV
Short-time withstand current	
Pollution severity	
Gauge to IEC 60947-1 / UL94 Flammability class	
Approvals	
Clamped conductors (H05V/H07V)	
solid / stranded	mm ²
flexible / Stranded wire with end ferrules	mm ²
Tightening torque range (clamping screw)	
Tightening torque range (fixing screw)	
Stripping length / Blade size	mm/-

Note

Ordering data

Version	Note
green/yellow Wemid	

Accessories

End plate / partition	End bracket	Screwdriver
Dark beige Wemid	Dark beige Wemid	Standard
	Dark beige Wemid	

Marking systems (see assortment in catalogue 7)
Marking tags

For detailed information on other accessories and applications, refer to the „Accessories“ section

WPE 2.5

2.5 mm²



5.1 x 60 x 47	
4	
0.05...4	

IEC 60947-7-2 Ex e ll II 2 G D

IEC	UL	CSA	EN 60079-7
2.5	AWG 30...12	AWG 30...12	2.5
800			
8			
	300 A (2.5 mm ²)		
	3		
	A3 / V-0		

Rated connection		Further connection	
0.5...4	1.5...4		
0.5...4	0.5...2.5		
0.4...0.8 Nm (M 2.5)			
0.4...0.8 Nm			
10 / 0.6 x 3.5 mm			

2.5 mm² conductor with wire end ferrule plus plastic collar only with collar optimised for diameter (order No. 1333100000, 500 pcs)

Type	Qty	Order No.
WPE 2.5	100	1010000000

Type	Width	Qty	Order No.
WAP 2.5-10	1.5 mm	50	1050000000
WEW 35/2	8 mm	100	1061200000
SD 0.6x3.5x100		1	9008330000

DEK 5/5 / WS 12/5
Rail support for insulated installation of terminal rail „SH 2“ order no. 0494920000 (10 pcs)

WPE 2.5N

2.5 mm²



Compact design

5.1 x 54 x 37.5	
4	
0.05...4	

IEC 60947-7-2 Ex e ll II 2 G D

IEC	UL	CSA	EN 60079-7
2.5	AWG 30...12	AWG 26...12	2.5
500			
6			
	300 A (2.5 mm ²)		
	3		
	A3 / V-0		

Rated connection		Further connection	
0.5...4	1.5...4		
0.5...4	0.5...2.5		
0.4...0.6 Nm (M 2.5)			
0.4...0.6 Nm			
10 / 0.6 x 3.5 mm			

2.5 mm² conductor with wire end ferrule plus plastic collar only with collar optimised for diameter (order No. 1333100000, 500 pcs)

Type	Qty	Order No.
WPE 2.5N	100	1016200000

Type	Width	Qty	Order No.
WAP WDU2.5N/4N	1.5 mm	50	1060000000
EW 35	8.5 mm	50	0383560000
SD 0.6x3.5x100		1	9008330000

DEK 5/5 / WS 12/5
Rail support for insulated installation of terminal rail „SH 2“ order no. 0494920000 (10 pcs)

WDK 2.5 PE

2.5 mm²



5.1 x 69.5 x 63
4
0.05...4



IEC 60947-7-2 Ex e II II 2 G D

IEC	UL	CSA	EN 60079-7
2.5	AWG 30...12	AWG 26...12	2.5
400			
6			
300 A (2.5 mm ²)			
3			
A3 / V-0			

Rated connection	Further connection
0.5...4 / 1.5...4	
0.5...4 / 0.5...2.5	
0.4...0.6 Nm (M 2.5)	

10 / 0.6 x 3.5 mm

2.5 mm² conductor with wire end ferrule plus plastic collar only with collar optimised for diameter (order No. 1333100000, 500 pcs)

Type	Qty	Order No.
WDK 2.5PE	100	1036300000

Type	Width	Qty	Order No.
WAP WDK2.5	1.5 mm	20	1059100000
WEW 35/2	8 mm	100	1061200000
SD 0.6x3.5x100		1	9008330000

DEK 5/5 / WS 8/5

Rail support for insulated installation of terminal rail „SH 2“ order no. 0494920000 (10 pcs)

WDK 2.5N PE

2.5 mm²

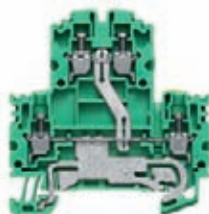

5.1 x 60.7 x 62.5
4
0.05...4

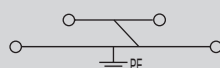

IEC 60947-7-2 Ex e II II 2 G D

IEC	UL	CSA	EN 60079-7
2.5	AWG 30...12	AWG 26...12	2.5
800			
8			
300 A (2.5 mm ²)			
3			
A3 / V-0			

Rated connection	Further connection
0.5...4 / 1.5...4	
0.5...4 / 0.5...2.5	
0.4...0.6 Nm (M 2.5)	

8 / 0.6 x 3.5 mm

2.5 mm² conductor with wire end ferrule plus plastic collar only with collar optimised for diameter (order No. 1333100000, 500 pcs)

Type	Qty	Order No.
WDK 2.5N PE	100	1041620000

Type	Width	Qty	Order No.
WAP WDK2.5/4 N	1.5 mm	20	1084000000
WEW 35/2	8 mm	100	1061200000
SD 0.6x3.5x100		1	9008330000

DEK 5/5 / WS 8/5

Rail support for insulated installation of terminal rail „SH 2“ order no. 0494920000 (10 pcs)

Modular PE terminals

Identical profiles from 2.5 to 10 mm² with uniform end and partition plates. An unsurpassed combination of many advantages!

Their small size compared to the respective rated cross-section makes the modular terminals with the compact design very popular.

In hazardous area applications, the installation instructions and the rated data specifications for accessories given in the technical appendix must be followed.

Width/Length/height with TS35x7.5	mm
max. cond. cross-section	mm ²
Max. clamping range	mm ²

Technical data

Rated data	
Rated cross-section	mm ²
Rated voltage to adjacent terminal	V
Rated impulse withstand voltage to adjacent terminal	kV
Short-time withstand current	
Pollution severity	
Gauge to IEC 60947-1 / UL94 Flammability class	
Approvals	
Clamped conductors (H05V/H07V)	
solid / stranded	mm ²
flexible / Stranded wire with end ferrules	mm ²
Tightening torque range (clamping screw)	
Tightening torque range (fixing screw)	
Stripping length / Blade size	mm/-

Note

Ordering data

Version
green/yellow Wemid
Note

Accessories

End plate / partition
Dark beige Wemid
End bracket
Dark beige Wemid
Dark beige Wemid
Screwdriver
Standard

Marking systems (see assortment in catalogue 7)
Marking tags

For detailed information on other accessories and applications, refer to the „Accessories“ section

WPE 4

4 mm²



6.1 x 56 x 47
6
0.13...6

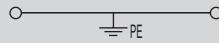

IEC 60947-7-2 Ex e ll II 2 G D

IEC	UL	CSA	EN 60079-7
4	AWG 22...10	AWG 26...10	4
800			
8			
	480 A (4 mm ²)		
	3		
	A4 / V-0		

Rated connection		Further connection	
0.5...6	0.5...6		
flexible	0.5...4		
Tightening torque	0.5...1.0 Nm (M 3)		
Tightening torque	0.5...0.8 Nm		
Stripping length	10 / 0.6 x 3.5 mm		

Type	Qty	Order No.
WPE 4	100	1010100000

Type	Width	Qty	Order No.
WEW 35/2	8 mm	100	1061200000
SD 0.6x3.5x100		1	9008330000

DEK 5/6 / WS 12/6
Rail support for insulated installation of terminal rail „SH 2“ order no. 0494920000 (10 pcs)

WPE 4/ZZ

4 mm²



Twin connection

6.1 x 70 x 53.5
6
0.13...6

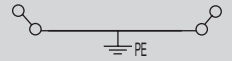

IEC 60947-7-2 Ex e ll

IEC	UL	CSA	EN 60079-7
4		AWG 30...10	4
800			
8			
	480 A (4 mm ²)		
	3		
	A4 / V-0		

Rated connection		Further connection	
0.5...6	0.5...4		
flexible	0.5...4		
Tightening torque	0.5...0.8 Nm (M 3)		
Stripping length	10 / 0.6 x 3.5 mm		

Type	Qty	Order No.
WPE 4/ZZ	50	1905130000

Type	Width	Qty	Order No.
WAP WDU/WTR4/ZZ	1.5 mm	50	1905150000
WEW 35/2	8 mm	100	1061200000
SD 0.6x3.5x100		1	9008330000

DEK 5/6 / WS 12/6
Rail support for insulated installation of terminal rail „SH 2“ order no. 0494920000 (10 pcs)

WPE 4/ZR

4 mm²

Supplementary connection, right



6.1 x 63.5 x 53.5

6

0.13...6

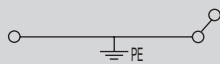

IEC 60947-7-2

Ex e II



IEC	UL	CSA	EN 60079-7
4		AWG 30...10	4
800			
8			
	480 A (4 mm ²)		
	3		
	A4 / V-0		



Rated connection	Further connection
0.5...6 / 0.5...4	
0.5...2.5 / 0.5...4	
0.5...0.8 Nm (M 3)	

10 / 0.6 x 3.5 mm

Type	Qty	Order No.
WPE 4/ZR	50	1905120000

Type	Width	Qty	Order No.
WAP WDU/WTR4/ZR	1.5 mm	50	1905070000
WEW 35/2	8 mm	100	1061200000
SD 0.6x3.5x100		1	9008330000

DEK 5/6 / WS 12/6

Rail support for insulated installation of terminal rail „SH 2“ order no. 0494920000 (10 pcs)

WPE 4N

4 mm²

Compact design



6.1 x 50 x 38.5

6

0.13...6

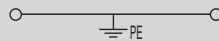

IEC 60947-7-2

Ex e II



II 2 G D

IEC	UL	CSA	EN 60079-7
4	AWG 26...10	AWG 26...10	4
500			
6			
	480 A (4 mm ²)		
	3		
	A3 / V-0		



Rated connection	Further connection
0.5...6 / 1.5...6	
0.5...4 / 0.5...4	
0.5...1.0 Nm (M 3)	

10 / 0.6 x 3.5 mm

Type	Qty	Order No.
WPE 4N	100	1042700000

Type	Width	Qty	Order No.
WAP WDU2.5N/4N	1.5 mm	50	1060000000
EW 35	8.5 mm	50	0383560000
SD 0.6x3.5x100		1	9008330000

DEK 5/6 / WS 12/6

Rail support for insulated installation of terminal rail „SH 2“ order no. 0494920000 (10 pcs)

WDK 4N PE

4 mm²

Compact design



6.1 x 60.7 x 64.1

6

0.13...6

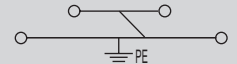

IEC 60947-7-2

Ex e II



II 2 G D

IEC	UL	CSA	EN 60079-7
4	AWG 26...10	AWG 26...10	4
800			
8			
	480 A (4 mm ²)		
	3		
	A3 / V-0		



Rated connection	Further connection
0.5...6 / 1.5...6	
0.5...4 / 0.5...4	
0.5...1.0 Nm (M 3)	

8 / 0.6 x 3.5 mm

Type	Qty	Order No.
WDK 4N PE	100	1041920000

Type	Width	Qty	Order No.
WAP WDK2.5/4 N	1.5 mm	20	1084000000
WEW 35/2	8 mm	100	1061200000
SD 0.6x3.5x100		1	9008330000

DEK 5/6 / WS 8/5

Rail support for insulated installation of terminal rail „SH 2“ order no. 0494920000 (10 pcs)

Modular PE terminals

Identical profiles from 2.5 to 10 mm² with uniform end and partition plates. An unsurpassed combination of many advantages!

Their small size compared to the respective rated cross-section makes the modular terminals with the compact design very popular.

In hazardous area applications, the installation instructions and the rated data specifications for accessories given in the technical appendix must be followed.

Width/Length/height with TS35x7.5	mm
max. cond. cross-section	mm ²
Max. clamping range	mm ²

Technical data

Rated data	
Rated cross-section	mm ²
Rated voltage to adjacent terminal	V
Rated impulse withstand voltage to adjacent terminal	kV
Short-time withstand current	
Pollution severity	
Gauge to IEC 60947-1 / UL94 Flammability class	
Approvals	
Clamped conductors (H05V/H07V)	
solid / stranded	mm ²
flexible / Stranded wire with end ferrules	mm ²
Tightening torque range (clamping screw)	
Tightening torque range (fixing screw)	
Stripping length / Blade size	mm/-
Note	

Ordering data

Version
green/yellow Wemid
Note

Accessories

End bracket
Dark beige Wemid
Screwdriver
Standard
PEN bridge

Marking systems
(see assortment in catalogue 7) Marking tags
For detailed information on other accessories and applications, refer to the „Accessories“ section

WPE 6

6 mm²



7.9 x 56 x 47
10
0.08...10

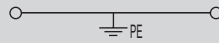

IEC 60947-7-2 Ex e ll II 2 G D

IEC	UL	CSA	EN 60079-7
6	AWG 22...8	AWG 20...8	6
800			
8			
720 A (6 mm ²)			
3			
A5 / V-0			

Rated connection		Further connection	
0.5...10	/ 1.5...10		
0.5...10	/ 0.5...6		
0.8...1.6 Nm	(M 3.5)		
0.5...1.0 Nm			
12 / 4.0 x 0.8 mm			
Conductor connection H07V...10 and AWG 8 tighten with 1.4-1.6 Nm.			

Type	Qty	Order No.
WPE 6	50	1010200000

Type	Width	Qty	Order No.
WEW 35/2	8 mm	100	1061200000
SD 0.8x4.0x100		1	9008340000

DEK 5/8 / WS 12/6,5
Rail support for insulated installation of terminal rail „SH 2“ order no. 0494920000 (10 pcs)

WPE 10

10 mm²



9.9 x 60 x 47
16
1.31...16

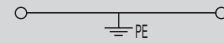

IEC 60947-7-2 Ex e ll II 2 G D

IEC	UL	CSA	EN 60079-7
10	AWG 16...6	AWG 16...6	10
1000			
8			
1200 A (10 mm ²)			
3			
B6 / V-0			

Rated connection		Further connection	
1.5...16	/ 1.5...16		
1.5...16	/ 1.5...16		
1.2...2.4 Nm	(M 4)		
0.5...1.0 Nm			
12 / 0.6 x 3.5 mm			
AWG 6/7 and H07V-R16 tighten with 2.4 Nm.			

Type	Qty	Order No.
WPE 10	50	1010300000

Type	Width	Qty	Order No.
WEW 35/2	8 mm	100	1061200000
SD 1.0x5.5x150		1	9008350000
WQB-PEN 10		10	1060300000

DEK 5/5 / WS 12/6,5
Rail support for insulated installation of terminal rail „SH 2“ order no. 0494920000 (10 pcs)

WPE 10/ZR

10 mm²

Supplementary connection, right (4 mm²)



9.9 x 66 x 49.5
16
1.31...16

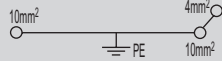

IEC 60947-7-2

IEC	UL	CSA
10	AWG 16...6	AWG 14...6
1000		
8		
	1200 A (10 mm ²)	
	3	
	B6 / A4 / V-0	

Rated connection	Further connection
1.5...16 / 1.5...16	0.5...6 / 1.5...4
1.5...16 / 1.5...16	0.5...4 / 1.5...16
1.2...2.4 Nm (M 4)	0.6...0.8 Nm (M 3)
0.5...1.0 Nm (M 3)	
12 / 0.6 x 3.5 mm	9 / 0.6 x 3.5 mm

Max. conductor cross-sections refer to 10 mm² connection. AWG 6/7 and H07V-R16 tighten with 2.4 Nm.

Type	Qty	Order No.
WPE 10/ZR	50	1042500000

Type	Width	Qty	Order No.
WEW 35/2	8 mm	100	1061200000
SD 0.6x3.5x100		1	9008330000
WQB-PEN 10		10	1060300000

DEK 5/5 / WS 12/6,5

Rail support for insulated installation of terminal rail „SH 2“ order no. 0494920000 (10 pcs)

WPE 16

16 mm²

Supplementary connection, right (4 mm²)



11.9 x 56 x 63
25
1.5...25

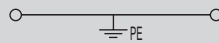

IEC 60947-7-2

IEC	UL	CSA	EN 60079-7
16	AWG 14...4	AWG 14...6	16
1000			
8			
	1920 A (16 mm ²)		
	3		
	B7 / V-0		

Rated connection	Further connection
1.5...16 / 1.5...25	
1.5...25 / 1.5...16	
2.0...4.0 Nm (M 5)	
3.0...4.0 Nm	
16 / 1.0 x 5.5 mm	

For 25mm², the TS 35x15 (steel, 1.5mm thick) should be used. Conductor connection H07V-..16 and AWG 6 with tightening torque of 2.0-2.4 Nm.

Type	Qty	Order No.
WPE 16	50	1010400000

Type	Width	Qty	Order No.
WEW 35/1	12 mm	50	1059000000
SD 1.0x5.5x150		1	9008350000
WQB-PEN 16		10	1060200000

DEK 5/5 / WS 12/6,5

Rail support for insulated installation of terminal rail „SH 2“ order no. 0494920000 (10 pcs)

WPE 16N

16 mm²

Compact design



12 x 56 x 47
25
1.5...25

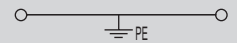

IEC 60947-7-2

IEC	UL	CSA
16	AWG 14...6	AWG 14...6
400		
6		
	1920 A (16 mm ²)	
	3	
	B7 / V-0	

Rated connection	Further connection
1.5...16 / 1.5...25	
1.5...16 / 1.5...16	
1.2...2.4 Nm (M 4)	
0.5...1.0 Nm	
12 / 1.0 x 5.5 mm	

25 mm² stranded requires a tightening torque of 2.2 Nm.

Type	Qty	Order No.
WPE 16N	50	1019100000

Type	Width	Qty	Order No.
WEW 35/2	8 mm	100	1061200000
SD 1.0x5.5x150		1	9008350000
WQB-PEN 16N		10	1071350000

DEK 5/5 / WS 12/6,5

Rail support for insulated installation of terminal rail „SH 2“ order no. 0494920000 (10 pcs)

Modular PE terminals

Identical profiles from 2.5 to 10 mm² with uniform end and partition plates. An unsurpassed combination of many advantages!

Their small size compared to the respective rated cross-section makes the modular terminals with the compact design very popular.

In hazardous area applications, the installation instructions and the rated data specifications for accessories given in the technical appendix must be followed.

Width/Length/height with TS35x7.5	mm
max. cond. cross-section	mm ²
Max. clamping range	mm ²

Technical data

Rated data	
Rated cross-section	mm ²
Rated voltage to adjacent terminal	V
Rated impulse withstand voltage to adjacent terminal	kV
Short-time withstand current	
Pollution severity	
Gauge to IEC 60947-1 / UL94 Flammability class	
Approvals	
Clamped conductors (H05V/H07V)	
solid / stranded	mm ²
flexible / Stranded wire with end ferrules	mm ²
Tightening torque range (clamping screw)	
Tightening torque range (fixing screw)	
Stripping length / Blade size	mm/-

Note

Ordering data

Version
green/yellow Wemid
Note

Accessories

End bracket
Dark beige Wemid
Screwdriver
Standard
PEN bridge

Marking systems (see assortment in catalogue 7)
Marking tags

For detailed information on other accessories and applications, refer to the „Accessories“ section

WPE 35

35 mm²



16 x 56 x 63	
50	
2.5...50	

IEC 60947-7-2 Ex e ll II 2 G D

IEC	UL	CSA	EN 60079-7
35	AWG 12...1	AWG 12...2	35
800			
8			
	4200 A (35 mm ²)		
	3		
	B8 / V-0		

Rated connection		Further connection	
2.5...16 / 2.5...50			
2.5...35 / 2.5...35			
4.0...5.0 Nm (M 6)			
1.2...2.4 Nm			
18 / 6.5 x 1.2 mm			

The torque is 4.5Nm for 16-50 mm² and AWG 6-2/7 stranded wires. Use TS 35x15 (1.5 mm thick) for 25mm² wires and TS 35x15(2.3mm thick) for 35mm²/50mm².

Type	Qty	Order No.
WPE 35	25	1010500000

Type	Width	Qty	Order No.
WEW 35/1	12 mm	50	1059000000
SD 1.2x6.5x150		1	9009010000
WQB-PEN 35		10	1060100000

DEK 5/5 / WS 12/6,5

Rail support for insulated installation of terminal rail „SH 2“ order no. 0494920000 (10 pcs)

WPE 35N

35 mm²

Compact design



16 x 66 x 51	
50	
2.5...50	

IEC 60947-7-2

IEC	UL	CSA
35	AWG 12...1/0	AWG 12...2
400		
6		
	4200 A (35 mm ²)	
	3	
	B8 / V-0	

Rated connection		Further connection	
2.5...16 / 2.5...50			
2.5...35 / 2.5...35			
4.0...5.0 Nm (M 6)			
1.2...2.4 Nm			
18 / 6.5 x 1.2 mm			

The torque is 4.5Nm for 16-50 mm² and AWG 6-2/7 stranded wires. Use TS 35x15 (1.5 mm thick) for 25mm² wires and TS 35x15(2.3mm thick) for 35mm²/50mm².

Type	Qty	Order No.
WPE 35N	20	1717740000

Type	Width	Qty	Order No.
WEW 35/2	8 mm	100	1061200000
SD 1.2x6.5x150		1	9009010000
WQV 16N-PEN BL		10	1071360000

DEK 5/5 / WS 12/6,5

Rail support for insulated installation of terminal rail „SH 2“ order no. 0494920000 (10 pcs)

WPE 50N

50 mm²

Compact design



18.5 x 71 x 70

70

10...70

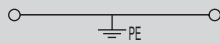

IEC 60947-7-2 Ex e II II 2 G D

IEC	UL	CSA	EN 60079-7
50	AWG 10...1	AWG 10...1	50
1000			
8			
	6000 A (50 mm ²)		
	3		
	B10 / V-0		

Rated connection	Further connection
10...16 / 10...70	
10...50 / 10...50	
4.0...6.0 Nm (M 6)	
3.0...4.0 Nm	
24 / S4 (DIN 6911)	

For 50 - 70 mm², the TS 35x15 (copper, 2.3mm thick) rail should be used.

Type	Qty	Order No.
WPE 50N	10	1846040000
UL, CSA and ATEX approvals in preparation.		

Type	Width	Qty	Order No.
WEW 35/1	12 mm	50	1059000000

DEK 5/5 / WS 12/6,5

Rail support for insulated installation of terminal rail „SH 2“ order no. 0494920000 (10 pcs)

WPE 70N/35

70 mm²

Compact design



20.5 x 75 x 86

95

10...95

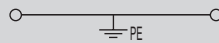

IEC 60947-7-2 Ex e II II 2 G D

IEC	UL	CSA	EN 60079-7
70	AWG 6...2/0	AWG 6...2/0	70
1000			
8			
	8400 A (70 mm ²)		
	3		
	B11 / V-0		

Rated connection	Further connection
10...16 / 10...95	
10...70 / 10...70	
8.0...10.0 Nm (M 8)	
2.0...4.0 Nm	
22 / S6 (DIN 6911)	

For 50 - 95 mm², the TS 35x15 (copper, 2.3mm thick) rail should be used.

Type	Qty	Order No.
WPE 70N/35	10	9512200000

Type	Width	Qty	Order No.
WEW 35/1	12 mm	50	1059000000
WQV 70N-PEN		5	9525840000

DEK 5/5 / WS 12/6,5

Rail support for insulated installation of terminal rail „SH 2“ order no. 0494920000 (10 pcs)

WPE 95N/120N

95 mm²

Compact design



27 x 91 x 90

150

16...150

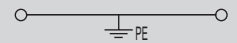

IEC 60947-7-2 Ex e II II 2 G D

IEC	UL	CSA	EN 60079-7
95	AWG 4...3/0	AWG 4...4/0	95
1000			
8			
	11400 A (95 mm ²)		
	3		
	B13 / V-0		

Rated connection	Further connection
16...16 / 16...150	
16...120 / 16...95	
12...20 Nm (M 10)	
2.0...4.0 Nm	
27 / S6 (DIN 6911)	

For 50 - 150 mm², the TS 35x15 (copper, 2.3mm thick) rail should be used.

Type	Qty	Order No.
WPE 95N/120N	5	1846030000
UL, CSA and ATEX approvals in preparation.		

Type	Width	Qty	Order No.
WEW 35/1	12 mm	50	1059000000

DEK 5/5 / WS 12/6,5

Rail support for insulated installation of terminal rail „SH 2“ order no. 0494920000 (10 pcs)

Modular PE terminals

Large conductor cross-sections do not require a great force to insert them into the clamping point, but instead can be easily and quickly placed in the modular terminal.

Every type of terminal is available in both single and block forms. All blocks are screwed permanently together and therefore provide additional torsional rigidity.

Direct mounting is possible thanks to the elongated holes on the underside of the terminal.

In hazardous area applications, the installation instructions and the rated data specifications for accessories given in the technical appendix must be followed.

Width/Length/height with TS35x7.5	mm
max. cond. cross-section	mm ²
Max. clamping range	mm ²

Technical data

Rated data	
Rated cross-section	mm ²
Rated voltage to adjacent terminal	V
Rated impulse withstand voltage to adjacent terminal	kV
Short-time withstand current	
Pollution severity	
Gauge to IEC 60947-1 / UL94 Flammability class	
Approvals	
Clamped conductors (H05V/H07V)	
solid / stranded	mm ²
flexible / Stranded wire with end ferrules	mm ²
Tightening torque range (clamping screw)	
Tightening torque range (fixing screw)	
Stripping length / Blade size	mm/-

Note

Ordering data

Version	
	green/yellow Wemid
Note	

Accessories

End bracket	
	Dark beige Wemid
Screwdriver	
	Standard
PEN bridge	

Marking systems (see assortment in catalogue 7)

Marking tags

For detailed information on other accessories and applications, refer to the „Accessories“ section

WPE 70/95

95 mm²

Conductor can be inserted from above / leaf spring

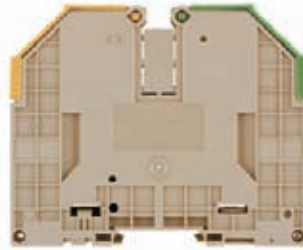

27 x 132 x 108

120

13.3...120

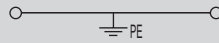

IEC 60947-7-2 Ex e ll II 2 G D

IEC	UL	CSA	EN 60079-7
95	AWG 6...2/0	AWG 6...2/0	95
1000			
8			
11400 A (95 mm ²)			
3			
B12 / V-0			



Rated connection	Further connection
16...16 / 16...120	
16...95 / 16...95	
6.0...12 Nm (M 8)	
3.0...6.0 Nm	
30 / S6 (DIN 6911)	

For 50 - 120 mm², the TS 35x15 (copper, 2.3mm thick) rail should be used.

Type	Qty	Order No.
WPE 70/95	10	1037300000

Type	Width	Qty	Order No.
WEW 35/1	12 mm	50	1059000000
WQV 70/95-PEN		5	1072300000

DEK 5/5 / WS 12/6,5

Rail support for insulated installation of terminal rail „SH 2“ order no. 0494920000 (10 pcs)

WPE 120/150

120 mm²

Conductor can be inserted from above / leaf spring

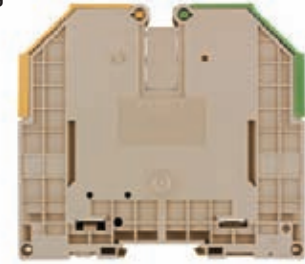

32 x 132 x 118

150

33.63...150

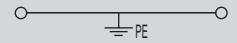

IEC 60947-7-2 Ex e ll II 2 G D

IEC	UL	CSA	EN 60079-7
120	AWG 2...kcmil 250	AWG 2...kcmil 250	120
1000			
8			
14400 A (120 mm ²)			
3			
B13 / V-0			



Rated connection	Further connection
/ 35...150	
35...150 / 35...95	
10...20 Nm (M 10)	
3.0...6.0 Nm	
35 / S6 (DIN 6911)	

For 50 - 150 mm², the TS 35x15 (copper, 2.3mm thick) rail should be used.

Type	Qty	Order No.
WPE 120/150	10	1019700000

Type	Width	Qty	Order No.
WEW 35/1	12 mm	50	1059000000
WQV 120-PEN		5	1072400000

DEK 5/5 / WS 12/6,5

Rail support for insulated installation of terminal rail „SH 2“ order no. 0494920000 (10 pcs)

Modular disconnect terminals enable circuits to be quickly isolated from the supply so that, for example, maintenance or repair work can be carried out.

In hazardous area applications, the installation instructions and the rated data specifications for accessories given in the technical appendix must be followed.

Width/Length/height with TS35x7.5	mm
max. current / max. cond. cross-section	A/mm ²
Max. clamping range	mm ²

Technical data

Rated data	
Rated voltage	V
Rated current	A
Rated cross-section	mm ²
Rated impulse voltage / Pollution severity	kV/-
Gauge to IEC 60947-1 / UL94 Flammability class	
Approvals	
Clamped conductors (H05V/H07V)	
solid / stranded	mm ²
flexible / Stranded wire with end ferrules	mm ²
Tightening torque range (clamping screw)	
Stripping length / Blade size	mm/-
2 conductors with same cross-section (H05V/H07V)	
solid / stranded	mm ²
flexible / Stranded wire with end ferrules	mm ²
Note	

Ordering data

Version	
	Dark beige Wemid
	Blue Wemid
	Without isolator, Dark beige Wemid
Note	

Accessories

Pluggable cross-connection	
	2-pole
	3-pole
	4-pole
	10-pole
End plate / partition	
	Dark beige Wemid
	Dark beige Wemid
End bracket	
	Dark beige Wemid
Screwdriver	
	Standard
Testing / Checking	
	Test plug
Holder for cartridge fuse, 5 x 20mm	
	400 V AC/DC, without LED
	10 - 36 V AC/DC, red LED
	140 - 250 V AC/DC, red LED
Module connector (max, 250 V)	
	without fittings
	with wire jumper
	With 1N4007 diode
Disconnect plug	
	yellow Wemid
Marking systems	
	(see assortment in catalogue 7)
	Marking tags
For detailed information on other accessories and applications, refer to the „Accessories“ section	

WTR 2.5

2.5 mm²

with clamping screw

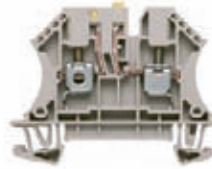

5.1 x 60 x 49
24 / 4
0.05...4

IEC 60947-7-1		
IEC	UL	CSA
500	600	300
24	20	10
2.5	AWG 30...12	AWG 26...12
6 / 3		
A3 / V-0		
UL		
Rated connection		
0.5...4 / 1.5...4		
0.5...4 / 0.5...2.5		
0.4...0.8 Nm (M 2.5)		
10 / 0.6 x 3.5 mm		
0.5...1.5		
0.5...1.5 / 0.5...1.5		
2.5 mm ² conductor with wire end ferrule plus plastic collar only with collar optimised for diameter (order No. 1333100000, 500 pcs)		

Type	Qty	Order No.
WTR 2.5	100	1855610000
WTR 2.5 BL	100	8731640000
WTR 2.5/O.TNHE	100	8731700000

Type	current	Qty	Order No.
ZQV 2.5N/2 GE	24 A	60	1693800000
ZQV 2.5N/3 GE	24 A	60	1693810000
ZQV 2.5N/4 GE	24 A	60	1693820000
ZQV 2.5N/10 GE	24 A	20	1693880000
Width			
WAP 2.5-10	1.5 mm	50	1050000000
WEW 35/2			
WEW 35/2	8 mm	100	1061200000
SD 0.6x3.5x100			
SD 0.6x3.5x100		1	9008330000
SIHA 3/G20			
SIHA 3/G20	6 mm	25	7921560000
SIHA 3/G20/LD 10-36V	6 mm	25	7921570000
SIHA 3/G20/LD 140-250V	6 mm	25	7921600000
BEST			
BEST	5.1 mm	50	1833100000
BEST/DRBR	5.1 mm	50	1878570000
BEST/D	5.1 mm	50	1878560000
TNST			
TNST		50	1833090000
DEK 5/5 / WS 12/5			
DEK 5/5 / WS 12/5			

WTR 2.5 StB

2.5 mm²

With sockets



5.1 x 60 x 49
24 / 4
0.05...4

IEC 60947-7-1		
IEC	UL	CSA
500	300	300
24	20	10
2.5	AWG 30...12	AWG 26...12
6 / 3		
A3 / V-0		
UL		
Rated connection		
0.5...4 / 1.5...4		
0.5...4 / 0.5...2.5		
0.5...0.7 Nm (M 3)		
10 / 0.6 x 3.5 mm		
0.5...1.5		
0.5...1.5 / 0.5...1.5		
2.5 mm ² conductor with wire end ferrule plus plastic collar only with collar optimised for diameter (order No. 1333100000, 500 pcs)		

Type	Qty	Order No.
WTR 2.5 STB2.3	100	1855620000
WTR 2.5 STB2.3 BL	100	8731660000
WTR 2.5/O.TNHE STB2.3	100	8731670000

Type	current	Qty	Order No.
ZQV 2.5N/2 GE	24 A	60	1693800000
ZQV 2.5N/3 GE	24 A	60	1693810000
ZQV 2.5N/4 GE	24 A	60	1693820000
ZQV 2.5N/10 GE	24 A	20	1693880000
Width			
WAP 2.5-10	1.5 mm	50	1050000000
WEW 35/2			
WEW 35/2	8 mm	100	1061200000
SD 0.6x3.5x100			
SD 0.6x3.5x100		1	9008330000
PS 2.3 RT			
PS 2.3 RT	5.4 mm	20	0180400000
SIHA 3/G20			
SIHA 3/G20	6 mm	25	7921560000
SIHA 3/G20/LD 10-36V	6 mm	25	7921570000
SIHA 3/G20/LD 140-250V	6 mm	25	7921600000
BEST			
BEST	5.1 mm	50	1833100000
BEST/DRBR	5.1 mm	50	1878570000
BEST/D	5.1 mm	50	1878560000
TNST			
TNST		50	1833090000
DEK 5/5 / WS 12/5			
DEK 5/5 / WS 12/5			

Test-disconnect terminals

Modular disconnect terminals enable circuits to be quickly isolated from the supply so that, for example, maintenance or repair work can be carried out.

In hazardous area applications, the installation instructions and the rated data specifications for accessories given in the technical appendix must be followed.

Width/Length/height with TS35x7.5	mm
max. current / max. cond. cross-section	A/mm ²
Max. clamping range	mm ²

Technical data

Rated data	
Rated voltage	V
Rated current	A
Rated cross-section	mm ²
Rated impulse voltage / Pollution severity	kV/-
Gauge to IEC 60947-1 / UL94 Flammability class	
Approvals	
Clamped conductors (H05V/H07V)	
solid / stranded	mm ²
flexible / Stranded wire with end ferrules	mm ²
Tightening torque range (clamping screw)	
Stripping length / Blade size	mm/-
2 conductors with same cross-section (H05V/H07V)	
solid / stranded	mm ²
flexible / Stranded wire with end ferrules	mm ²
Note	

Ordering data

Version	
	Dark beige Wemid
	Blue Wemid
	Without isolator, Dark beige Wemid
Note	

Accessories

Pluggable cross-connection	
	2-pole
	3-pole
	4-pole
	10-pole
End plate / partition	
	Dark beige Wemid
	Dark beige Wemid
End bracket	
	Dark beige Wemid
Screwdriver	
	Standard
Testing / Checking	
	Test plug
Holder for cartridge fuse, 5 x 20mm	
	400 V AC/DC, without LED
	10 - 36 V AC/DC, red LED
	140 - 250 V AC/DC, red LED
Module connector (max, 250 V)	
	without fittings
	with wire jumper
	With 1N4007 diode
Disconnect plug	
	yellow Wemid
Marking systems	
	(see assortment in catalogue 7)
	Marking tags
For detailed information on other accessories and applications, refer to the „Accessories“ section	

WTR 2.5/ZZ

2.5 mm²

Twin connection

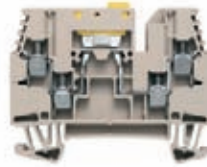

5.1 x 60 x 49	
14 / 4	
0.13...4	

IEC 60947-7-1		
IEC	UL	CSA
400	300	300
14	10	10
2.5	AWG 26...12	AWG 26...12
6 / 3		
A3 / V-0		
Rated connection		
0.5...4 / 1.5...4		
0.5...4 / 0.5...2.5		
0.5...0.6 Nm (M 3)		
7 / 0.6 x 3.5 mm		
0.5...1.5		
0.5...1.5 / 0.5...1.5		

Type	Qty	Order No.
WTR 2.5/ZZ	100	1039900000
WTR 2.5/ZZ BL	100	1039980000
2.5 mm ² conductor with wire end ferrule plus plastic collar only with collar optimised for diameter (order No. 1333100000, 500 pcs)		

Type	current	Qty	Order No.
ZQV 2.5/2	24 A	60	1608860000
ZQV 2.5/3	24 A	60	1608870000
ZQV 2.5/4	24 A	60	1608880000
ZQV 2.5/10	24 A	20	1608940000
Width			
WAP WTR2.5/ZZ	1.5 mm	20	1074600000
Width			
WEW 35/2	8 mm	100	1061200000
SD 0.6x3.5x100		1	9008330000
PS 2.3 RT	5.4 mm	20	0180400000
SIHA 1/G20	6 mm	25	9537550000
SIHA 1/G20 10-36V	6 mm	25	9537560000
SIHA 1/G20 140-250V	6 mm	25	9537590000
Width			
WEW 35/2	8 mm	100	1061200000
SD 0.6x3.5x100		1	9008330000
Width			
DEK 5/5 / WS 12/5			

WDTR 2.5

2.5 mm²

Double disconnect terminal



6.2 x 94 x 69	
14 / 4	
0.05...4	

IEC 60947-7-1		
IEC	UL	CSA
400	300	300
10	10	10
2.5	AWG 30...12	AWG 26...12
4 / 3		
A3 / V-0		
Rated connection		
0.5...4 / 1.5...4		
0.5...2.5 / 0.5...2.5		
0.5...0.6 Nm (M 3)		
8 / 0.6 x 3.5 mm		
0.5...1.5		
0.5...1.5 / 0.5...1.5		

Type	Qty	Order No.
WDTR 2.5	25	9528070000
WDTR 2.5 BL	25	9528080000

Type	Qty	Order No.
Width		
WEW 35/2	8 mm	100
SD 0.6x3.5x100		1
Width		
WEW 35/2	8 mm	100
SD 0.6x3.5x100		1
Width		
DEK 5/6 / WS 8/5		
External cross-connection is possible with the VQB 1.5/50. Refer to „Accessories“ Chapter.		

WTR 4

4 mm²

with clamping screw

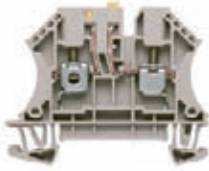

6.1 x 60 x 48.6
32 / 6
0.22...6

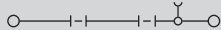

IEC 60947-7-1

IEC	UL	CSA
400	600	300
32	22	10
4	AWG 22...10	AWG 22...10
6 / 3		
A4 / V-0		



Rated connection

0.5...6 / 1.5...4
 0.5...4 / 0.5...4
 0.5...0.6 Nm (M 3)
 13 / 0.6 x 3.5 mm
 0.5...1.5
 0.5...1.5 / 0.5...1.5

Type	Qty	Order No.
WTR 4	50	7910180000
WTR 4 BL	50	7910190000

Type	current	Qty	Order No.
ZQV 4N/2 GE	32 A	60	1758250000
ZQV 4N/3 GE	32 A	60	1762630000
ZQV 4N/4 GE	32 A	60	1762620000
ZQV 4N/10 GE	32 A	20	1758260000
Width			
WAP 2.5-10	1.5 mm	50	1050000000
WAP 16+35 WTW 2.5-10	1.5 mm	20	1050100000
Width			
WEW 35/2	8 mm	100	1061200000
SD 0.6x3.5x100		1	9008330000
Width			
SIHA 3/G20	6 mm	25	7921560000
SIHA 3/G20/LD 10-36V	6 mm	25	7921570000
SIHA 3/G20/LD 140-250V	6 mm	25	7921600000
Width			
BEST	5.1 mm	50	1833100000
BEST/DRBR	5.1 mm	50	1878570000
BEST/D	5.1 mm	50	1878560000
Width			
TNST		50	1833090000

DEK 5 / WS 12/5

WTR 4 StB

4 mm²

With socket



6.1 x 60 x 48.6
32 / 6
0.22...6

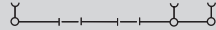

IEC 60947-7-1

IEC	UL	CSA
400	600	300
32	22	10
4	AWG 22...10	AWG 22...10
6 / 3		
A4 / V-0		



Rated connection

0.5...6 / 1.5...6
 0.5...4 / 0.5...4
 0.5...0.6 Nm (M 3)
 13 / 0.6 x 3.5 mm
 0.5...1.5
 0.5...1.5 / 0.5...1.5

Type	Qty	Order No.
WTR 4 STB	50	7910210000
WTR 4 STB BL	50	7910220000

Type	current	Qty	Order No.
ZQV 4N/2 GE	32 A	60	1758250000
ZQV 4N/3 GE	32 A	60	1762630000
ZQV 4N/4 GE	32 A	60	1762620000
ZQV 4N/10 GE	32 A	20	1758260000
Width			
WAP 2.5-10	1.5 mm	50	1050000000
WAP 16+35 WTW 2.5-10	1.5 mm	20	1050100000
Width			
WEW 35/2	8 mm	100	1061200000
SD 0.6x3.5x100		1	9008330000
Width			
PS 2.3 RT	5.4 mm	20	0180400000
Width			
SIHA 3/G20	6 mm	25	7921560000
SIHA 3/G20/LD 10-36V	6 mm	25	7921570000
SIHA 3/G20/LD 140-250V	6 mm	25	7921600000
Width			
BEST	5.1 mm	50	1833100000
BEST/DRBR	5.1 mm	50	1878570000
BEST/D	5.1 mm	50	1878560000
Width			
TNST		50	1833090000

DEK 5 / WS 12/5

WTR 4/ZZ

4 mm²

Twin connection with clamping screw

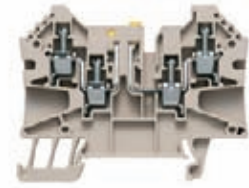

6.1 x 70 x 53.5
27 / 6
0.13...6

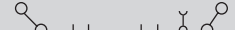

IEC 60947-7-1

IEC	UL	CSA
500	600	600
27	25	25
4	AWG 30...10	AWG 30...10
6 / 3		
A4 / V-0		



Rated connection

0.5...6 / 0.5...6
 0.5...4 / 0.5...4
 0.5...0.6 Nm (M 3)
 10 / 0.6 x 3.5 mm
 0.5...1.5
 0.5...1.5 / 0.5...1.5

Type	Qty	Order No.
WTR 4/ZZ	50	1905090000

Type	current	Qty	Order No.
ZQV 4N/2 GE	32 A	60	1758250000
ZQV 4N/3 GE	32 A	60	1762630000
ZQV 4N/4 GE	32 A	60	1762620000
ZQV 4N/10 GE	32 A	20	1758260000
Width			
WAP WDU/WTR4/ZZ	1.5 mm	50	1905150000
Width			
WEW 35/2	8 mm	100	1061200000
SD 0.6x3.5x100		1	9008330000
Width			
SIHA 3/G20	6 mm	25	7921560000
SIHA 3/G20/LD 10-36V	6 mm	25	7921570000
SIHA 3/G20/LD 140-250V	6 mm	25	7921600000
Width			
BEST	5.1 mm	50	1833100000
BEST/DRBR	5.1 mm	50	1878570000
BEST/D	5.1 mm	50	1878560000
Width			
TNST		50	1833090000

DEK 5 / WS 12/5

Test-disconnect terminals

Modular disconnect terminals enable circuits to be quickly isolated from the supply so that, for example, maintenance or repair work can be carried out.

In hazardous area applications, the installation instructions and the rated data specifications for accessories given in the technical appendix must be followed.

Width/Length/height with TS35x7.5	mm
max. current / max. cond. cross-section	A/mm ²
Max. clamping range	mm ²

Technical data

Rated data	
Rated voltage	V
Rated current	A
Rated cross-section	mm ²
Rated impulse voltage / Pollution severity	kV/-
Gauge to IEC 60947-1 / UL94 Flammability class	
Approvals	
Clamped conductors (H05V/H07V)	
solid / stranded	mm ²
flexible / Stranded wire with end ferrules	mm ²
Tightening torque range (clamping screw)	
Stripping length / Blade size	mm/-
2 conductors with same cross-section (H05V/H07V)	
solid / stranded	mm ²
flexible / Stranded wire with end ferrules	mm ²
Note	

Ordering data

Version	
	Dark beige Wemid
	Blue Wemid
	Without isolator, Dark beige Wemid
Note	

Accessories

Pluggable cross-connection	
	2-pole
	3-pole
	4-pole
	10-pole
End plate / partition	
	Dark beige Wemid
	Dark beige Wemid
End bracket	
	Dark beige Wemid
Screwdriver	
	Standard
Testing / Checking	
	Test plug
Holder for cartridge fuse, 5 x 20mm	
	400 V AC/DC, without LED
	10 - 36 V AC/DC, red LED
	140 - 250 V AC/DC, red LED
Module connector (max. 250 V)	
	without fittings
	with wire jumper
	With 1N4007 diode
Disconnect plug	
	yellow Wemid
Marking systems	
	(see assortment in catalogue 7)
	Marking tags
For detailed information on other accessories and applications, refer to the „Accessories“ section	

WTR 4/ZZ StB

4 mm²

Twin connection with socket

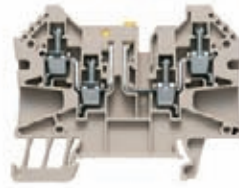

6.1 x 70 x 53.5

27 / 6

0.13...6

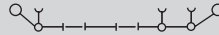

IEC 60947-7-1

IEC	UL	CSA
500	600	600
27	25	25
4	AWG 30...10	AWG 30...10
6 / 3		
A4 / V-0		



Rated connection

0.5...6 / 0.5...6

0.5...4 / 0.5...4

0.5...0.8 Nm (M 3)

10 / 0.6 x 3.5 mm

0.5...1.5

0.5...1.5 / 0.5...1.5

WTR 4/ZR

4 mm²

Supplementary connection, right, with clamping screw

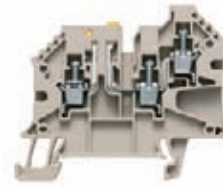

6.1 x 63.5 x 53.5

27 / 6

0.13...6

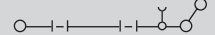

IEC 60947-7-1

IEC	UL	CSA
500	600	600
27	25	25
4	AWG 30...10	AWG 30...10
6 / 3		
A4 / V-0		



Rated connection

0.5...6 / 0.5...6

0.5...4

0.5...0.8 Nm (M 3)

10 / 0.6 x 3.5 mm

0.5...1.5 / 0.5...1.5

0.5...1.5 / 0.5...1.5

Type	Qty	Order No.
WTR 4/ZZ STB	50	1905100000

Type	Qty	Order No.
WTR 4/ZR	50	1905080000

Type	current	Qty	Order No.
ZQV 4N/2 GE	32 A	60	1758250000
ZQV 4N/3 GE	32 A	60	1762630000
ZQV 4N/4 GE	32 A	60	1762620000
ZQV 4N/10 GE	32 A	20	1758260000
Width			
WAP WDU/WTR4/ZZ	1.5 mm	50	1905150000
Width			
WEW 35/2	8 mm	100	1061200000
SD 0.6x3.5x100		1	9008330000
PS 2.3 RT	5.4 mm	20	0180400000
SIHA 3/G20	6 mm	25	7921560000
SIHA 3/G20/LD 10-36V	6 mm	25	7921570000
SIHA 3/G20/LD 140-250V	6 mm	25	7921600000
BEST	5.1 mm	50	1833100000
BEST/DRBR	5.1 mm	50	1878570000
BEST/D	5.1 mm	50	1878560000
TNST		50	1833090000
DEK 5/5 / WS 12/5			

Type	current	Qty	Order No.
ZQV 4N/2 GE	32 A	60	1758250000
ZQV 4N/3 GE	32 A	60	1762630000
ZQV 4N/4 GE	32 A	60	1762620000
ZQV 4N/10 GE	32 A	20	1758260000
Width			
WAP WDU/WTR4/ZR	1.5 mm	50	1905070000
Width			
WEW 35/2	8 mm	100	1061200000
SD 0.6x3.5x100		1	9008330000
SIHA 3/G20	6 mm	25	7921560000
SIHA 3/G20/LD 10-36V	6 mm	25	7921570000
SIHA 3/G20/LD 140-250V	6 mm	25	7921600000
BEST	5.1 mm	50	1833100000
BEST/DRBR	5.1 mm	50	1878570000
BEST/D	5.1 mm	50	1878560000
TNST		50	1833090000
DEK 5/5 / WS 12/5			

WTR 4/ZR StB

4 mm²

Supplementary connection, right, with socket

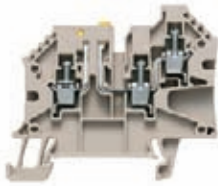

6.1 x 63.5 x 53.5

27 / 6

0.13...6

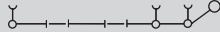

IEC 60947-7-1

IEC	UL	CSA
500	600	600
27	25	25
4	AWG 30...10	AWG 30...10
	6 / 3	
	A4 / V-0	



Rated connection

0.5...6 / 0.5...6

0.5...4 / 0.5...4

0.5...0.8 Nm (M 3)

10 / 0.6 x 3.5 mm

0.5...1.5

0.5...1.5 / 0.5...1.5

Type	Qty	Order No.
WTR 4/ZR STB	50	1905110000

Type	current	Qty	Order No.
ZQV 4N/2 GE	32 A	60	1758250000
ZQV 4N/3 GE	32 A	60	1762630000
ZQV 4N/4 GE	32 A	60	1762620000
ZQV 4N/10 GE	32 A	20	1758260000

Width			
WAP WDU/WTR4/ZR	1.5 mm	50	1905070000

Width			
WEW 35/2	8 mm	100	1061200000

SD 0.6x3.5x100		1	9008330000
----------------	--	---	-------------------

PS 2.3 RT	5.4 mm	20	0180400000
-----------	--------	----	-------------------

SIHA 3/G20	6 mm	25	7921560000
------------	------	----	-------------------

SIHA 3/G20/LD 10-36V	6 mm	25	7921570000
----------------------	------	----	-------------------

SIHA 3/G20/LD 140-250V	6 mm	25	7921600000
------------------------	------	----	-------------------

BEST	5.1 mm	50	1833100000
------	--------	----	-------------------

BEST/DRBR	5.1 mm	50	1878570000
-----------	--------	----	-------------------

BEST/D	5.1 mm	50	1878560000
--------	--------	----	-------------------

TNST		50	1833090000
------	--	----	-------------------

DEK 5/5 / WS 12/5

WDT 1.5/1

1.5 mm²

Disconnection lower level

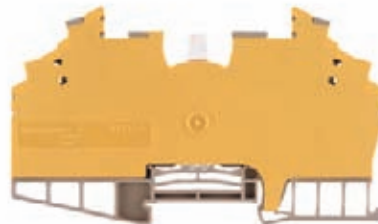

6.4 x 112 x 66.7

10 / 2.5

0.13...2.5



IEC 60947-7-1

IEC	UL	CSA
250	300	300
10	10	10
1.5	AWG 22...14	AWG 26...14
	4 / 3	
	A2 / V-0	



Rated connection

0.5...2.5 / 1.5...2.5

0.5...1.5 / 0.5...1.5

0.4...0.6 Nm (M 2.5)

10 / 0.6 x 3.5 mm

Type	Qty	Order No.
WDT 1.5/1 DB/GE	25	1015800000

Type	Qty	Order No.

Width			
WEW 35/2	8 mm	100	1061200000

SD 0.6x3.5x100		1	9008330000
----------------	--	---	-------------------

DEK 5/6,5 / WS 8/5

WDT 1.5/2

1.5 mm²

Disconnection both levels



6.4 x 112 x 66.7

10 / 2.5

0.13...2.5



IEC 60947-7-1

IEC	UL	CSA
250	300	300
10	10	10
1.5	AWG 22...14	AWG 26...14
	4 / 3	
	A2 / V-0	



Rated connection

0.5...2.5 / 1.5...2.5

0.5...1.5 / 0.5...1.5

0.4...0.6 Nm (M 2.5)

10 / 0.6 x 3.5 mm

Type	Qty	Order No.
WDT 1.5/2 DB/GE	25	1015900000

Type	Qty	Order No.

Width			
WEW 35/2	8 mm	100	1061200000

SD 0.6x3.5x100		1	9008330000
----------------	--	---	-------------------

DEK 5/6,5 / WS 8/5

WTR 2.5/SI

2.5 mm²

WTR 4/SI

4 mm²

In hazardous area applications, the installation instructions and the rated data specifications for accessories given in the technical appendix must be followed.

Width/Length/height with TS35x7.5	mm
max. current / max. cond. cross-section	A/mm ²
Max. clamping range	mm ²



5.1 x 60 x 80.5	
6.3 / 4	
0.05...4	



6.1 x 60 x 80.5	
6.3 / 6	
0.22...6	

Technical data

Rated data	
Rated voltage	V
Rated current	A
Rated cross-section	mm ²
Rated impulse voltage / Pollution severity	kV/-
Gauge to IEC 60947-1 / UL94 Flammability class	
Approvals	
Clamped conductors (H05V/H07V)	
solid / stranded	mm ²
flexible / Stranded wire with end ferrules	mm ²
Tightening torque range (clamping screw)	
Stripping length / Blade size	mm/-
2 conductors with same cross-section (H05V/H07V)	
solid / stranded	mm ²
flexible / Stranded wire with end ferrules	mm ²
Note	

IEC 60947-7-3		
IEC	UL	CSA
400	300	300
6.3	6.3	6.3
2.5	AWG 30...12	AWG 26...12
6 / 3		
A3 / V-0		
Rated connection		
0.5...4 / 1.5...4		
0.5...4 / 0.5...2.5		
0.4...0.8 Nm (M 2.5)		
10 / 0.6 x 3.5 mm		
0.5...1.5		
0.5...1.5 / 0.5...1.5		
2.5 mm ² conductor with wire end ferrule plus plastic collar only with collar optimised for diameter (order No. 1333100000, 500 pcs)		

IEC 60947-7-3		
IEC	UL	CSA
400	300	300
6.3	6.3	6.3
4	AWG 22...10	AWG 22...10
6 / 3		
A4 / V-0		
Rated connection		
0.5...6 / 1.5...6		
0.5...4 / 0.5...4		
0.5...1.0 Nm (M 3)		
13 / 0.6 x 3.5 mm		
0.5...2.5		
0.5...1.5 / 0.5...1.5		
The rated current of the terminal is determined by the max. power loss of 1.6 W at the cartridge fuse.		

Ordering data

Version	
400 V AC/DC, without LED	
10-36 V AC/DC, with LED	
30-70 V AC/DC, with LED	
60-150 V AC/DC, with LED	
140-250 V AC/DC, with LED	
Note	

Type	Qty	Order No.
WTR 2.5/SI	25	1763940000
WTR 2.5/SI LD 36V	25	1763950000
WTR 2.5/SI LD 70V	25	1763960000
WTR 2.5/SI LD 150V	25	1763970000
WTR 2.5/SI LD 250V	25	1763980000
UL/CSA specified for 400 V cartridge fuse; otherwise the specified voltage range also applies for UL/CSA.		

Type	Qty	Order No.
WTR 4 SI	25	7910240000
WTR 4/SI LD 36V	25	7914370000
WTR 4/SI LD 70V	25	7914380000
WTR 4/SI LD 150V	25	7914390000
WTR 4/SI LD 250V	25	7914400000
UL/CSA specified for 400 V cartridge fuse; otherwise the specified voltage range also applies for UL/CSA.		

Accessories

Pluggable cross-connection	
	2-pole
	3-pole
	4-pole
	10-pole
End plate / partition	
	Dark beige Wemid
	Dark beige Wemid
Screwdriver	
	Standard
G-fuse cartridge, 5 x 20mm (IEC 60127-2)	
	0,25 A fast
	0,50 A fast
	1,00 A fast
	2,00 A fast

Type	Qty	Order No.
Width		
WAP 2.5-10	1.5 mm	50 1050000000
WAP 16+35 WTW 2.5-10	1.5 mm	20 1050100000
SD 0.6x3.5x100		1 9008330000
G 20/0.25A/F	10	0430500000
G 20/0.50A/F	10	0430600000
G 20/1.00A/F	10	0430700000
G 20/2.00A/F	10	0430900000

Type	current	Qty	Order No.
ZQV 4N/2 GE	32 A	60	1758250000
ZQV 4N/3 GE	32 A	60	1762630000
ZQV 4N/4 GE	32 A	60	1762620000
ZQV 4N/10 GE	32 A	20	1758260000
Width			
WAP 2.5-10	1.5 mm	50	1050000000
WAP 16+35 WTW 2.5-10	1.5 mm	20	1050100000
SD 0.6x3.5x100		1	9008330000
G 20/0.25A/F		10	0430500000
G 20/0.50A/F		10	0430600000
G 20/1.00A/F		10	0430700000
G 20/2.00A/F		10	0430900000

Marking systems	(see assortment in catalogue 7)
Marking tags	
For detailed information on other accessories and applications, refer to the „Accessories“ section	

DEK 5/5 / WS 12/5	
Cross-connection options for WTR 2.5, refer to the „W-Series Accessories“ section	

DEK 5/6 / WS 12/6	
-------------------	--

Fuse terminals

Roof-style

WTR 35 E

6 mm²

Operation mode



In hazardous area applications, the installation instructions and the rated data specifications for accessories given in the technical appendix must be followed.

Width/Length/height with TS35x15	mm
max. current / max. cond. cross-section	A/mm ²
Max. clamping range	mm ²

32 x 100 x 68
100 / 35
35

Technical data

Rated data	
Rated current	A
Rated cross-section	mm ²
Rated voltage / Pollution severity	V/-
Gauge to IEC 60947-1 / UL94 Flammability class	
Approvals	

IEC	UL	CSA
100		
35		
24	6 / 3	
		B9 / V-0

Clamped conductors	
„e“ solid H07V-U	mm ²
„m“ stranded H07V-R	mm ²
„f“ flexible H07V-K	mm ²
„f“ flexible H07V-K mit AEH	mm ²
Tightening torque range clamping screw	Nm
Tightening torque slider screw	Nm
Stripping length/Clamping screw/Blade size	mm/-

Rated connection	
4...16	
10...35	
4...35	
4...35	
4	
1.2	
18 / M6 / 6.5 x 1.2	

Note

Ordering data

Version
Dark beige Wemid, 230 V UC

Type	Qty	Order No.
WTR 35 E	5	1045970000

Note

Accessories

End bracket
Dark beige Wemid

Screwdriver
slot-head screwdriver

Type	Width	Qty	Order No.
WEW 35/1	12 mm	50	1059000000
SD 1.2 x 6.5 x 150		1	9009010000

Marking Systems (see assortment in catalogue 7)
Marking tags

WS 12/6

For detailed information on other accessories and applications, refer to the „Accessories“ section

Operating mode

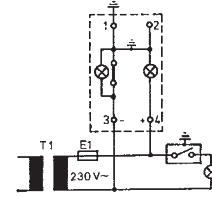

- Slide link is closed
- Auxiliary circuit is **earthed**
- Display is illuminated green

Test position

When measuring insulation resistance with voltages greater than UNom, the earth connection must first be disconnected.

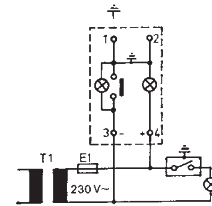

- Slide link is opened
- Auxiliary circuit is **not earthed**
- **No** earth fault
- Display illuminated green and red with reduced intensity
- Disconnected earth connection -> When measuring insulation resistance with voltages greater than UNom, the earth connection must be disconnected.

Operational malfunction

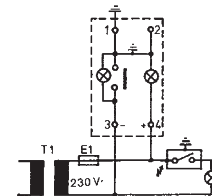

- Slide link is opened
- Auxiliary circuit is **not earthed**
- **Earth fault**
- Display is illuminated red

Fuse terminals

In hazardous area applications, the installation instructions and the rated data specifications for accessories given in the technical appendix must be followed.

Width/Length/height with TS35x7.5	mm
max. current / max. cond. cross-section	A/mm ²
Max. clamping range	mm ²

Technical data

Rated data	
Rated voltage	V
Rated current	A
Rated cross-section	mm ²
Rated impulse voltage / Pollution severity	V/-
Gauge to IEC 60947-1 / UL94 Flammability class	Approvals
Clamped conductors (H05V/H07V)	
solid / stranded	mm ²
flexible / Stranded wire with end ferrules	mm ²
Tightening torque range (clamping screw)	
Stripping length / Blade size	mm/-
2 conductors with same cross-section (H05V/H07V)	
solid / stranded	mm ²
flexible / Stranded wire with end ferrules	mm ²
Note	

Ordering data

Version	
	400 V AC/DC, without LED
	10-36 V AC/DC, with LED
	30-70 V AC/DC, with LED
	60-150 V AC/DC, with LED
	140-250 V AC/DC, with LED
Note	

Accessories

Screwable cross-connection	
	2-pole 3-pole 4-pole 10-pole
End plate / partition	
	Dark beige Wemid Dark beige Wemid
Screwdriver	
	with „swifty set“ cutting device Standard
G-fuse cartridge, 5 x 20mm (IEC 60127-2)	
	0,25 A fast 0,50 A fast 1,00 A fast 2,00 A fast
G25 with indicator / imperial (inch) fuse	
	0,50 A medium slow / 2 A 1,00 A medium slow / 3 A 2,00 A fast / 5 A 4,00 A fast / 10 A
Marking systems	
	(see assortment in catalogue 7) Marking tags
For detailed information on other accessories and applications, refer to the „Accessories“ section	

WSI 4/2

4 mm²

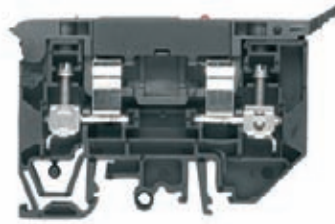

9.1 x 81.6 x 54	
15 / 4	
0.5...4	

IEC 60947-7-3		
IEC	UL	CSA
500	300	300
15	15	15
4	AWG 22...10	AWG 22...10
6 /		
A3 / V-0		
Rated connection		
0.5...4 / 0.5...4		
0.5...4 / 0.5...4		
0.5...0.8 Nm (M 3)		
10 / 0.6 x 3.5 mm		
0.5...1.5		
0.5...1.5 / 0.5...1.5		
width x length x height with TS 32 = 9.1 x 81.6 x 58.5 mm		

Type	Qty	Order No.
WSI 4/2	25	1880430000
WSI 4/2/LD 10-36V AC/DC	25	1880410000
WSI 4/2/LD 30-70V AC/DC	25	1880440000
WSI 4/2/LD 60-150V AC/DC	25	1880420000
WSI 4/2/LD 140-250V AC/DC	25	1880390000

Type	Qty	Order No.
Width		
WAP WSI4/2	50	1880450000
SWIFTY SET		
SWIFTY SET	1	9006060000
SD 0.6x3.5x100	1	9008330000
G 20/0.25A/F		
GZ 2.0A	10	0294500000
GZ 3.0A	10	0295700000
GZ 5.0A	10	0294600000
GZ 10.0A	10	0293900000

DEK 5/5 / WS 12/6
Dummy cartridge fuse order No. 1582770000

WSI 4

4 mm²

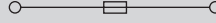

8 x 50.7 x 39.4	
15 / 4	
0.5...4	

IEC 60947-7-3		
IEC	UL	CSA
500	300	300
12	15	15
4	AWG 22...12	AWG 22...12
6 / 3		
A3 / V-0		
Rated connection		
0.5...4 / 0.5...4		
0.5...4 / 0.5...4		
0.5...0.8 Nm (M 3)		
8 / 0.6 x 3.5 mm		
0.5...1.5		
0.5...1.5 / 0.5...1.5		

Type	Qty	Order No.
WSI 4	50	1886580000
WSI 4/LD 10-36V AC/DC	50	1886590000
WSI 4/LD 30-70V AC/DC	50	1886560000
WSI 4/LD 60-150V AC/DC	50	1886570000
WSI 4/LD 140-250V AC/DC	50	1886550000

Type	Qty	Order No.
SWIFTY SET		
SWIFTY SET	1	9006060000
SD 0.6x3.5x100	1	9008330000
G 20/0.25A/F		
G 20/0.25A/F	10	0430500000
G 20/0.50A/F	10	0430600000
G 20/1.00A/F	10	0430700000
G 20/2.00A/F	10	0430900000

DEK 5/5 / WS 12/6

KDKS 1/35 DB

4 mm²

Metric fuses 5 x 20 mm

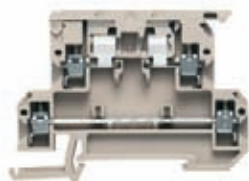

8 x 73.5 x 55.6
6.3 / 4
0.22...4

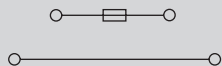

IEC 60947-7-3

IEC	UL	CSA
500	300	
6.3	10	
4	AWG 22...12	
	6 / 3	
	A3 / V-0	



Rated connection

0.5...4 / 1.5...4
 0.5...4 / 0.5...4
 0.5...0.8 Nm (M 3)
 8 / 0.6 x 3.5 mm

0.5...1.5
 0.5...1.5 / 0.5...1.5

Note: max. conductor size = 2.5 mm² when using the cross-connection.

Type	Qty	Order No.
KDKS 1/35 DB	50	9532440000

Max. power loss (1.6 W) at the cartridge fuse limits the rated current.

Type	Qty	Order No.
Width		
AP KDKS1 1.5 DB	1.5 mm	20 9532470000
Width		
G 20/0.25A/F	10	0430500000
G 20/0.50A/F	10	0430600000
G 20/1.00A/F	10	0430700000
G 20/2.00A/F	10	0430900000

DEK 5/8

WSI 6

6 mm²

Metric fuses

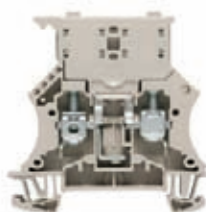

7.9 x 60 x 62
6.3 / 10
0.5...10

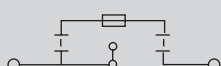

IEC 60947-7-3

IEC	UL	CSA
500	600	300
6.3	10	10
6	AWG 20...8	AWG 20...8
	6 / 3	
	A5 / V-0	



Rated connection

0.5...10 / 1.5...10
 0.5...10 / 0.5...6
 0.8...1.6 Nm (M 3.5)
 12 / 4.0 x 0.8 mm

0.5...2.5
 0.5...2.5 / 0.5...2.5

Cartridge fuses or contact sleeves have to be inserted centrally. Version with contact sleeve, order No. 1028200000 (50 pcs/11 A).

Type	Qty	Order No.
WSI 6	50	1011000000

Max. power loss (1.6 W) at the cartridge fuse limits the rated current.

Type	current	Qty	Order No.
QL 2 SAK6N	57 A	50	0194300000
QL 3 SAK6N	57 A	50	0194400000
QL 4 SAK6N	57 A	50	0194500000
QL 10 SAK6N	57 A	20	0338300000
Width			
WAP 2.5-10	1.5 mm	50	1050000000
WAP 16+35 WTW 2.5-10	1.5 mm	20	1050100000
Width			
SD 0.8x4.0x100		1	9008340000
G 20/0.25A/F	10	0430500000	
G 20/0.50A/F	10	0430600000	
G 20/1.00A/F	10	0430700000	
G 20/2.00A/F	10	0430900000	
Width			
G 25/0.50A/M WS	10	0510300000	
G 25/1.00A/M RT	10	0265800000	
G 25/2.00A/F BL	10	0192700000	
G 25/4.00A/F BR	10	0192800000	

DEK 5/8 / WS 12/6,5

Screw M3 x 5 order No. 1052100000 for QL 2 - QL 10.

WSI 6 LD

6 mm²

Metric fuses / bipolar LED

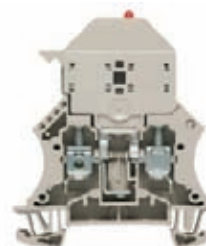

7.9 x 60 x 72
6.3 / 10
0.5...10

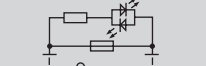

IEC 60947-7-3

IEC	UL	CSA
500	300	300
6.3	6.3	6.3
6	AWG 20...8	AWG 20...8
	6 / 3	
	A5 / V-0	



Rated connection

0.5...10 / 1.5...10
 0.5...10 / 0.5...6
 0.8...1.6 Nm (M 3.5)
 12 / 4.0 x 0.8 mm

0.5...2.5
 0.5...2.5 / 0.5...2.5

Cartridge fuses or contact sleeves have to be inserted centrally. A defective fuse causes a residual current to flow via the LED!

Type	Qty	Order No.
WSI 6/LD 10-36V DC/AC	50	1011300000
WSI 6/LD 30-70V DC/AC	50	1012200000
WSI 6/LD 60-150V DC/AC	50	1012300000
WSI 6/LD 250AC	50	1012400000

Max. power loss (1.6 W) at the cartridge fuse limits the rated current.

Type	current	Qty	Order No.
QL 2 SAK6N	32 A	50	0194300000
QL 3 SAK6N	57 A	50	0194400000
QL 4 SAK6N	57 A	50	0194500000
QL 10 SAK6N	32 A	20	0338300000
Width			
WAP 2.5-10	1.5 mm	50	1050000000
WAP 16+35 WTW 2.5-10	1.5 mm	20	1050100000
Width			
SD 0.8x4.0x100		1	9008340000
G 20/0.25A/F	10	0430500000	
G 20/0.50A/F	10	0430600000	
G 20/1.00A/F	10	0430700000	
G 20/2.00A/F	10	0430900000	
Width			
G 25/0.50A/M WS	10	0510300000	
G 25/1.00A/M RT	10	0265800000	
G 25/2.00A/F BL	10	0192700000	
G 25/4.00A/F BR	10	0192800000	

DEK 5/8 / WS 12/6,5

Screw M3 x 5 order No. 1052100000 for QL 2 - QL 10.

Fuse terminals

In hazardous area applications, the installation instructions and the rated data specifications for accessories given in the technical appendix must be followed.

Width/Length/height with TS35x7.5	mm
max. current / max. cond. cross-section	A/mm ²
Max. clamping range	mm ²

Technical data

Rated data	
Rated voltage	V
Rated current	A
Rated cross-section	mm ²
Rated impulse voltage / Pollution severity	kV/-
Gauge to IEC 60947-1 / UL94 Flammability class	
Approvals	

Clamped conductors (H05V/H07V)

solid / stranded	mm ²
flexible / Stranded wire with end ferrules	mm ²
Tightening torque range (clamping screw)	
Stripping length / Blade size	mm/-
2 conductors with same cross-section (H05V/H07V)	
solid / stranded	mm ²
flexible / Stranded wire with end ferrules	mm ²

Note

Ordering data

Version	
	400 V AC/DC, without LED
	10-36 V AC/DC, with LED
	30-70 V AC/DC, with LED
	60-150 V AC/DC, with LED
	140-250 V AC/DC, with LED

Note

Accessories

Screwable cross-connection

2-pole	
3-pole	
4-pole	
10-pole	
Lock washer	
Mounting screw	

End plate / partition

Dark beige Wemid	
Dark beige Wemid	

Fuse cartridges

Marking systems

(see assortment in catalogue 7)

Marking tags

For detailed information on other accessories and applications, refer to the „Accessories“ section

WSI 6/2

6 mm²

Imperial fuses

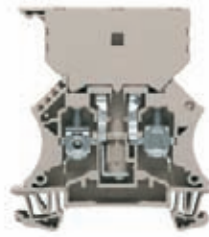

11.9 x 60 x 67
6.3 / 10
0.5...10

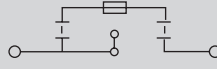

IEC 60947-7-3

IEC	UL	CSA
500	600	600
6.3	20	16
6	AWG 20...8	AWG 20...8
6 / 3		
A5 / V-0		

IEC 60947-7-3

Rated connection	
0.5...10 / 1.5...10	
0.5...10 / 0.5...6	
0.8...1.6 Nm (M 3.5)	
12 / 4.0 x 0.8 mm	
0.5...2.5	
0.5...2.5 / 0.5...2.5	

Cartridge fuses or contact sleeves have to be inserted centrally.

Type	Qty	Order No.
WSI 6/2 GZ/DEF63	25	101400000

Max. power loss (1.6 W) at the cartridge fuse limits the rated current.

Type	current	Qty	Order No.
QL 2 SAK16	76 A	50	0470700000
QL 3 SAK16	76 A	50	0470800000
QL 4 SAK16	76 A	50	0470900000
QL 10 SAK16	76 A	20	0471000000
SS M3 D 128-A 3		50	0164400000
KISC M3X5		100	1052100000
Width			
WAP 2.5-10	1.5 mm	50	1050000000
WAP 16+35 WTW 2.5-10	1.5 mm	20	1050100000
GZ 2.0A		10	0294500000
GZ 3.0A		10	0295700000
GZ 5.0A		10	0294600000
GZ 10.0A		10	0293900000

WSI 6/2 m. LED

6 mm²

Imperial fuses / bipolar LED

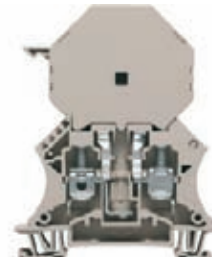

11.9 x 60 x 79.5
6.3 / 10
0.5...10

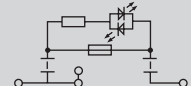

IEC 60947-7-3

IEC	UL	CSA
500	220	220
6.3	6.3	6.3
6	AWG 20...8	AWG 20...8
6 / 3		
A5 / V-0		

IEC 60947-7-3

Rated connection	
0.5...10 / 1.5...10	
0.5...10 / 0.5...6	
0.8...1.6 Nm (M 3.5)	
12 / 4.0 x 0.8 mm	
0.5...2.5	
0.5...2.5 / 0.5...2.5	

Cartridge fuses or contact sleeves have to be inserted centrally.

Type	Qty	Order No.
WSI 6/2/LD 10-36V DC/AC	25	1014100000
WSI 6/2/LD 30-70V DC/AC	25	1014200000
WSI 6/2/LD 60-150VDC/AC	25	1014300000
WSI 6/2/LD 250AC	25	1014400000

Max. power loss (1.6 W) at the cartridge fuse limits the rated current.

Type	current	Qty	Order No.
QL 2 SAK16	76 A	50	0470700000
QL 3 SAK16	76 A	50	0470800000
QL 4 SAK16	76 A	50	0470900000
QL 10 SAK16	76 A	20	0471000000
SS M3 D 128-A 3		50	0164400000
KISC M3X5		100	1052100000
Width			
WAP 2.5-10	1.5 mm	50	1050000000
WAP 16+35 WTW 2.5-10	1.5 mm	20	1050100000
GZ 2.0A		10	0294500000
GZ 3.0A		10	0295700000
GZ 5.0A		10	0294600000
GZ 10.0A		10	0293900000

DEK 5/8 / WS 12/6.5

Cross-connection, see section „W-series accessories“

WSI 25 10x38

25 mm²



n

WSI 25 CC

25 mm²



n

In hazardous area applications, the installation instructions and the rated data specifications for accessories given in the technical appendix must be followed.

Width/Length/height with TS35x7.5	mm
max. current / max. cond. cross-section	A
Max. clamping range	mm ²

36 x 58 x 81
32 / 25
1.5...25

54 x 58 x 81
32 / 25
1.5...25

Technical data

Rated data	
Rated voltage	V
Rated current	A
Rated cross-section	mm ²
Rated impulse voltage / Pollution severity	kV/-
Gauge to IEC 60947-1 / UL94 Flammability class	
Approvals	
Clamped conductors (H05V/H07V)	
solid / stranded	mm ²
flexible / Stranded wire with end ferrules	mm ²
Tightening torque range (clamping screw)	
Stripping length / Blade size	mm/-

IEC	UL	CSA
690	600	600
32	30	30
25	AWG 18...4	AWG 18...4
/ V-0		
Rated connection		
1.5...25 / 1.5...25		
2.0...4.0 Nm		

IEC	UL	CSA
690	600	600
32	30	30
25	AWG 18...4	AWG 18...4
/ V-0		
Rated connection		
1.5...25 / 1.5...25		
2.0...4.0 Nm		

Note

Ordering data

Version	
1-pole, without LED	
2-pole, without LED	
3-pole, without LED	
1-pole, with LED	

Type	Qty	Order No.
WSI 25/1 10x38	12	1966020000
WSI 25/2 10x38	6	1966090000
WSI 25/3 10x38	4	1966080000
WSI 25/1 10x38/LED	12	1966060000

Type	Qty	Order No.
WSI 25/1 CC	12	1966050000
WSI 25/2 CC	6	1966040000
WSI 25/3 CC	4	1966030000
WSI 25/1 CC/LED	12	1966070000

Note

Marking systems (see assortment in catalogue 7)

Marking tags

For detailed information on other accessories and applications, refer to the „Accessories“ section

ESG 6/15

ESG 6/15

Technical drawing

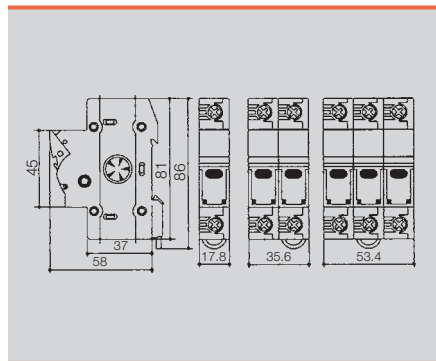
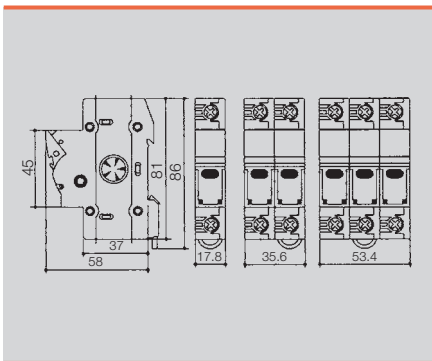

Fuse terminals

In hazardous area applications, the installation instructions and the rated data specifications for accessories given in the technical appendix must be followed.

Width/Length/height with TS35x7.5	mm
max. current / max. cond. cross-section	A/mm ²
Max. clamping range	mm ²

Technical data

Rated data	
Rated voltage	V
Rated current	A
Rated cross-section	mm ²
Rated impulse voltage / Pollution severity	kV/-
Gauge to IEC 60947-1 / UL94 Flammability class	Approvals
Clamped conductors (H05V/H07V)	
solid / stranded	mm ²
flexible / Stranded wire with end ferrules	mm ²
Tightening torque range (clamping screw)	
Stripping length / Blade size	mm/-
Note	

Ordering data

Version	400 V AC/DC, without LED
Note	

Accessories

Screwable cross-connection	
2-pole	
3-pole	
4-pole	
10-pole	
Lock washer	
Mounting screw	
End plate / partition	
Dark beige Wemid	
Screw cover cap	
SK	
Fuse cartridges	
Gauge rings	

Marking systems	
(see assortment in catalogue 7)	
Marking tags	
For detailed information on other accessories and applications, refer to the „Accessories“ section	

SAKS 2/35 DB

10 mm²

D-fuses E16



27.6 x 80 x 75	
10 / 16	
0.22...16	

IEC 60947-7-3		
IEC	UL	CSA
500		600
10		25
10		AWG 22...8
		6 / 3
		B6 / 5VA
Rated connection		
0.5...16 / 0.5...10		
0.5...10 / 0.5...10		
1.2...2.4 Nm (M 4)		
12 / 1.0 x 5.5 mm		
Note		
Connections for stranded conductors from 10 mm ² and AWG conductors require a tightening torque of 2 Nm.		

Type	Qty	Order No.
SAKS 2/35 DB	20	1368700000
Material thermosetting plastic KRG		

Type	current	Qty	Order No.																																								
QL 2 SAKS2	36 A	20	0207800000																																								
QL 3 SAKS2	36 A	20	0207900000																																								
QL 4 SAKS2	36 A	20	0208000000																																								
QL 10 SAKS2	36 A	20	0338900000																																								
SS M4 D 128-A 4		100	0136400000																																								
BFSC M4X9T		100	0103300000	Width				WTW EN	3 mm	20	1058800000	SK E16/SAKS2		25	0284110000	E 16/10A RT TNDZ		25	0208500000	E 16/16A GR TNDZ		25	0208600000	E 16/20A BL TNDZ		25	0208700000	E 16/25A GE TNDZ		25	0208800000	P 16/10 RT SAKS2		100	0208900000	P 16/16 GR SAKS2		100	0209000000	P 16/20 BL SAKS2		100	0209100000
Width																																											
WTW EN	3 mm	20	1058800000																																								
SK E16/SAKS2		25	0284110000																																								
E 16/10A RT TNDZ		25	0208500000																																								
E 16/16A GR TNDZ		25	0208600000																																								
E 16/20A BL TNDZ		25	0208700000																																								
E 16/25A GE TNDZ		25	0208800000																																								
P 16/10 RT SAKS2		100	0208900000																																								
P 16/16 GR SAKS2		100	0209000000																																								
P 16/20 BL SAKS2		100	0209100000																																								

Marking systems	
DEK 5/5	
Spare screw cap, order No. 0284110000 (20 pcs)	

SAKS 4/35 DB

10 mm²

D 01 fuses E14



24 x 75 x 66	
16 / 16	
0.22...16	

IEC 60947-7-3		
IEC	UL	CSA
400		600
16		30
10		AWG 22...8
		6 / 3
		B6 / 5VA
Rated connection		
0.5...16 / 0.5...10		
0.5...10 / 0.5...10		
1.2...2.4 Nm (M 4)		
14 / 1.0 x 5.5 mm		
Note		
400V also available with Neozed shipbuilding fuse. When connecting 10 mm ² stranded and 7-wire AWG conductor, the tightening torque is 2 Nm		

Type	Qty	Order No.
SAKS 4/35 DB	20	0501800000
Material thermosetting plastic KRG		

Type	current	Qty	Order No.																																				
QL 2 SAKS4	36 A	20	0328000000																																				
QL 3 SAKS4	36 A	20	0328100000																																				
QL 4 SAKS4	36 A	20	0328200000																																				
QL 10 SAKS4	36 A	20	0339000000																																				
SS M4 D 128-A 4		100	0136400000																																				
BFSC M4X9T		100	0103300000	Width				WTW EN	3 mm	20	1058800000	SK E14 SAKS4		20	0339410000	E 14/2A RS		10	0137400000	E 14/4A BR		10	0137500000	E 14/6A GN		10	0328300000	E 14/10A RT		10	0328400000	P 14/2 D01 RS SAKS4		50	0138000000	P 14/4 D01 BR SAKS4		50	0138100000
Width																																							
WTW EN	3 mm	20	1058800000																																				
SK E14 SAKS4		20	0339410000																																				
E 14/2A RS		10	0137400000																																				
E 14/4A BR		10	0137500000																																				
E 14/6A GN		10	0328300000																																				
E 14/10A RT		10	0328400000																																				
P 14/2 D01 RS SAKS4		50	0138000000																																				
P 14/4 D01 BR SAKS4		50	0138100000																																				

Marking systems	
DEK 5/5	
Spare screw cap, order No. 0339410000 (20 pcs)	

SAKS 5/35 DB

10 mm²

D 02 fuse E18



28 x 80 x 66

63 / 16

1.5...16

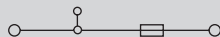

IEC 60947-7-3

IEC	UL	CSA
400	600	600
57	40	63
10	AWG 14...6	AWG 14...6
	6 / 3	
	B7 / 5VA	

UL, CE, RoHS, REACH, VDE

Rated connection

1.5...16 / 1.5...16

1.5...16 / 1.5...16

1.2...2.4 Nm (M 4)

13 / 1.0 x 5.5 mm

400V also available with Neozed shipbuilding fuse. When connecting 10 mm² stranded and 7-wire AWG conductor, the tightening torque is 2 Nm

Type	Qty	Order No.
SAKS 5/35 DB	20	0502100000
Material thermosetting plastic KRG		

Type	current	Qty	Order No.
QL 2 SAKS2	36 A	20	0207800000
QL 3 SAKS2	36 A	20	0207900000
QL 4 SAKS2	36 A	20	0208000000
QL 10 SAKS2	36 A	20	0338900000
SS M4 D 128-A 4		100	0136400000
BFSC M4X9T		100	0103300000
Width			
WTW EN	3 mm	20	1058800000
SK E18 SAKS5		20	0359310000
E 18/20A BL		10	0361300000
E 18/25A GE		10	0361400000
E 18/35A SW		10	0361500000
P 18/20 D02 BL SAKS5		50	0361800000
P 18/25 D02 GE SAKS5		50	0361900000
P 18/35 D02 SW SAKS5		50	0362000000
P 18/50 D02 WS SAKS5		50	0362100000

DEK 5/5

Spare screw cap, order No. 0359310000 (20 pcs)

Installation terminals

Distribution terminal with WQV

N-busbars may not be used in certain applications (medical systems). Instead, installation terminals with a disconnecter in the centre of the terminal can be used.

In hazardous area applications, the installation instructions and the rated data specifications for accessories given in the technical appendix must be followed.

Width/Length/height with TS35x7.5	mm
max. current / max. cond. cross-section	A/mm ²
Max. clamping range	mm ²



Technical data

Rated data	
Rated voltage	V
Rated current	A
Rated cross-section	mm ²
Rated impulse voltage / Pollution severity	kV/-
Gauge to IEC 60947-1 / UL94 Flammability class	
Approvals	
Clamped conductors (H05V/H07V)	
solid / stranded	mm ²
flexible / Stranded wire with end ferrules	mm ²
Tightening torque range (clamping screw)	
Stripping length / Blade size	mm/-
Note	

Ordering data

Version	
	Dark beige Wemid
Note	

Accessories

Screwable cross-connection	
	2-pole
	3-pole
	4-pole
	10-pole
	20-/24-pole
End plate / partition	
	Dark beige Wemid
Mounting plate for 10 x 3 (required every 20 cm)	
	Dark beige Wemid
End bracket	
	Dark beige Wemid
Screwdriver	
	with „swifty set“ cutting device
	Standard

Marking systems	(see assortment in catalogue 7)
	Marking tags
For detailed information on other accessories and applications, refer to the „Accessories“ section	

WDL 2.5/NT/L/PE

2.5 mm²

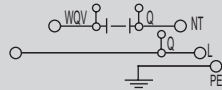

6.1 x 90 x 49	
32 / 4	
0.13...4	

IEC 60947-7-1 (-7-2)

IEC	UL	CSA
400	300	300
24	15	10
2.5	AWG 22...12	AWG 26...12
4 / 3		
A3 / A4 / V-0		

Rated connection	
0.5...4 / 1.5...4	
0.5...4 / 0.5...2.5	
0.4...0.6 Nm (M 2.5)	
8 / 0.6 x 3.5 mm	
Further connection refers to clamping point at top left (A4) 2-conductor, 1.5 mm ² , solid, with 0.6 Nm	

Type	Qty	Order No.
WDL 2.5/NT/L/PE	50	1029800000
PE connection marked green/yellow		

Type	current	Qty	Order No.
Q 2 WDL2.5S	24 A	50	1071500000
Q 3 WDL2.5S	24 A	50	1071600000
Q 4 WDL2.5S	24 A	50	1071700000
Q 10 WDL2.5S	24 A	20	1071800000
Q 20 WDL2.5S	24 A	20	1074200000
Width			
WAP WDL2.5	1.5 mm	20	1067800000
WHP WDL2.5/S BL	1.5 mm	20	1067980000
Width			
WEW 35/2	8 mm	100	1061200000
SWIFTY SET		1	9006060000
SDI 0,6x3,5x100		1	9008390000

Marking systems	(see assortment in catalogue 7)
	DEK 5/6 / WS 8/5
For detailed information on other accessories and applications, refer to the „Accessories“ section	

WDL 2.5/L/L

2.5 mm²

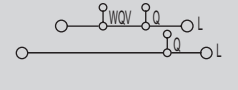

6.1 x 90 x 49	
32 / 4	
0.13...4	

IEC 60947-7-1

IEC	UL	CSA
400	300	300
24	15	10
2.5	AWG 22...12	AWG 26...12
6 / 3		
A3 / A4 / V-0		

Rated connection	
0.5...4 / 1.5...4	
0.5...4 / 0.5...2.5	
0.4...0.6 Nm (M 2.5)	
8 / 0.6 x 3.5 mm	
Further connection refers to clamping point at top left (A4) 2-conductor, 1.5 mm ² , solid, with 0.6 Nm	

Type	Qty	Order No.
WDL 2.5/L/L	50	1030300000
WDL 2.5/N/L order no. 1030000000 (upper connection marked blue)		

Type	current	Qty	Order No.
Q 2 WDL2.5S	24 A	50	1071500000
Q 3 WDL2.5S	24 A	50	1071600000
Q 4 WDL2.5S	24 A	50	1071700000
Q 10 WDL2.5S	24 A	20	1071800000
Q 20 WDL2.5S	24 A	20	1074200000
Width			
WAP WDL2.5	1.5 mm	20	1067800000
WHP WDL2.5/S BL	1.5 mm	20	1067980000
Width			
WEW 35/2	8 mm	100	1061200000
SWIFTY SET		1	9006060000
SDI 0,6x3,5x100		1	9008390000

Marking systems	(see assortment in catalogue 7)
	DEK 5/6 / WS 8/5
For detailed information on other accessories and applications, refer to the „Accessories“ section	

WDL 2.5/N/L/PE

2.5 mm²

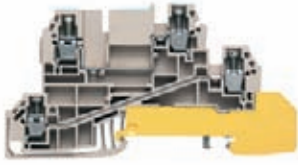

6.1 x 90 x 49
32 / 4
0.13...4

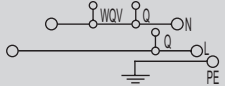

IEC 60947-7-1 (-7-2)

IEC	UL	CSA
400	300	300
24	15	10
2.5	AWG 22...12	AWG 26...12
4 / 3		
A3 / A4 / V-0		



Rated connection

0.5...4 / 1.5...4
0.5...4 / 0.5...2.5
0.4...0.6 Nm (M 2.5)
8 / 0.6 x 3.5 mm

Further connection refers to clamping point at top left (A4)
2-conductor, 1.5 mm², solid, with 0.6 Nm

Type	Qty	Order No.
WDL 2.5/N/L/PE	50	1029900000
PE connection marked green/yellow		

Type	current	Qty	Order No.
Q 2 WDL2.5S	24 A	50	1071500000
Q 3 WDL2.5S	24 A	50	1071600000
Q 4 WDL2.5S	24 A	50	1071700000
Q 10 WDL2.5S	24 A	20	1071800000
Q 20 WDL2.5S	24 A	20	1074200000
Width			
WAP WDL2.5	1.5 mm	20	1067800000
WHP WDL2.5/S BL	1.5 mm	20	1067980000
WEW 35/2	8 mm	100	1061200000
SWIFTY SET		1	9006060000
SDI 0,6x3,5x100		1	9008390000

DEK 5/6 / WS 8/5

WDL 2.5/L/L/PE

2.5 mm²

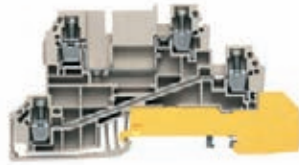

6.1 x 90 x 49
32 / 4
0.13...4

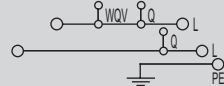

IEC 60947-7-1 (-7-2)

IEC	UL	CSA
400	300	300
24	15	10
2.5	AWG 22...12	AWG 26...12
4 / 3		
A3 / A4 / V-0		



Rated connection

0.5...4 / 1.5...4
0.5...4 / 0.5...2.5
0.4...0.6 Nm (M 2.5)
8 / 0.6 x 3.5 mm

Further connection refers to clamping point at top left (A4)
2-conductor, 1.5 mm², solid, with 0.6 Nm

Type	Qty	Order No.
WDL 2.5/L/L/PE	50	1030200000
PE connection marked green/yellow		

Type	current	Qty	Order No.
Q 2 WDL2.5S	24 A	50	1071500000
Q 3 WDL2.5S	24 A	50	1071600000
Q 4 WDL2.5S	24 A	50	1071700000
Q 10 WDL2.5S	24 A	20	1071800000
Q 20 WDL2.5S	24 A	20	1074200000
Width			
WAP WDL2.5	1.5 mm	20	1067800000
WHP WDL2.5/S BL	1.5 mm	20	1067980000
WEW 35/2	8 mm	100	1061200000
SWIFTY SET		1	9006060000
SDI 0,6x3,5x100		1	9008390000

DEK 5/6 / WS 8/5

WDL 2.5/L

2.5 mm²

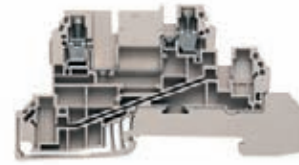

6.1 x 90 x 49
32 / 4
0.13...4

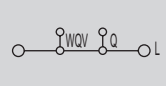

IEC 60947-7-1

IEC	UL	CSA
400	300	300
24	15	10
2.5	AWG 22...12	AWG 26...12
6 / 3		
A3 / A4 / V-0		



Rated connection

0.5...4 / 1.5...4
0.5...4 / 0.5...2.5
0.4...0.6 Nm (M 2.5)
8 / 0.6 x 3.5 mm

Further connection refers to clamping point at top left (A4)
2-conductor, 1.5 mm², solid, with 0.6 Nm

Type	Qty	Order No.
WDL 2.5/L	50	1030400000
WDL 2.5/N order no. 1030100000 (upper connection marked blue)		

Type	current	Qty	Order No.
Q 2 WDL2.5S	24 A	50	1071500000
Q 3 WDL2.5S	24 A	50	1071600000
Q 4 WDL2.5S	24 A	50	1071700000
Q 10 WDL2.5S	24 A	20	1071800000
Q 20 WDL2.5S	24 A	20	1074200000
Width			
WAP WDL2.5	1.5 mm	20	1067800000
WHP WDL2.5/S BL	1.5 mm	20	1067980000
WEW 35/2	8 mm	100	1061200000
SWIFTY SET		1	9006060000
SDI 0,6x3,5x100		1	9008390000

DEK 5/6 / WS 8/5

Installation terminals

Distribution terminals with 10x3 bus-bar

Space-saving wiring of three-phase circuits using only two terminals.

In hazardous area applications, the installation instructions and the rated data specifications for accessories given in the technical appendix must be followed.

Width/Length/height with TS35x7.5	mm
max. current / max. cond. cross-section	A/mm ²
Max. clamping range	mm ²



Technical data

Rated data	
Rated voltage	V
Rated current	A
Rated cross-section	mm ²
Rated impulse voltage / Pollution severity	kV/-
Gauge to IEC 60947-1 / UL94 Flammability class	Approvals
Clamped conductors (H05V/H07V)	
solid / stranded	mm ²
flexible / Stranded wire with end ferrules	mm ²
Tightening torque range (clamping screw)	
Stripping length / Blade size	mm/-
Note	

Ordering data

Version	
	Dark beige Wemid
Note	

Accessories

Screwable cross-connection	
	2-pole
	3-pole
	4-pole
	10-pole
End plate / partition	
	Dark beige Wemid
Mounting plate for 10 x 3 (required every 20 cm)	
	Dark beige Wemid
End bracket	
	Dark beige Wemid
Screwdriver	
	with „swiftly set“ cutting device
	Standard
Busbar 10 x 3 (140 A)	
	OK, Busbar up to OK, TS35 = 25,5 mm
Clamping yoke for power supply to 10 x 3 busbars	
	Rigid / flexible 0,5 - 6 / 4 mm ²
	rigid / flexible 6 - 16 mm ²
	Flexible 16 - 35 mm ²
Marking systems	
	(see assortment in catalogue 7)
	Marking tags
For detailed information on other accessories and applications, refer to the „Accessories“ section	

WDL 2.5/S/NT/L/PE

2.5 mm²



6.1 x 84.5 x 49
32 / 4
0.13...4

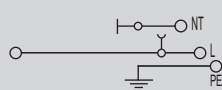

IEC 60947-7-1 (-7-2)

IEC	UL	CSA
400	300	300
24	15	10
2.5	AWG 22...12	AWG 26...12
4 / 3		
A3 / V-0		



Rated connection

0.5...4 / 1.5...4
0.5...4 / 0.5...2.5
0.4...0.6 Nm (M 2.5)
8 / 0.6 x 3.5 mm

Rated voltage of L-PE and L-NT: 250 V
Tightening torque of isolator: 0.4...0.6 Nm

WDL 2.5/S/L/L

2.5 mm²



6.1 x 84.5 x 49
32 / 4
0.13...4

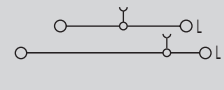

IEC 60947-7-1

IEC	UL	CSA
400	300	300
24	15	10
2.5	AWG 22...12	AWG 26...12
6 / 3		
A3 / V-0		



Rated connection

0.5...4 / 1.5...4
0.5...4 / 0.5...2.5
0.4...0.6 Nm (M 2.5)
8 / 0.6 x 3.5 mm

Type	Qty	Order No.
WDL 2.5/S/NT/L/PE	50	1030600000
PPE connection marked green/yellow, three-phase circuit together with WDL 2.5/S/L/L		

Type	Qty	Order No.
WDL 2.5/S/L/L	50	1031200000
WDL 2.5/S/N/L order no. 1030800000 (upper connection marked blue)		

Type	current	Qty	Order No.
Q 2 WDL2.5S	24 A	50	1071500000
Q 3 WDL2.5S	24 A	50	1071600000
Q 4 WDL2.5S	24 A	50	1071700000
Q 10 WDL2.5S	24 A	20	1071800000
Width			
WAP WDL2.5/S	1.5 mm	20	1067700000
WHP WDL2.5/S BL	1.5 mm	20	1067980000
WEW 35/2			
WEW 35/2	8 mm	100	1061200000
SWIFTY SET			
SWIFTY SET		1	9006060000
SD 0.6x3.5x100		1	9008330000
SSCH 10X3X1000 CU/SN			
SSCH 10X3X1000 CU/SN	10 mm	1	0348900000
ZB 4			
ZB 4	5.6 mm	50	0316500000
ZB 16 ZKSC	10 mm	50	0316600000
ZB 35/M6X16	14 mm	20	0266500000

Type	current	Qty	Order No.
Q 2 WDL2.5S	24 A	50	1071500000
Q 3 WDL2.5S	24 A	50	1071600000
Q 4 WDL2.5S	24 A	50	1071700000
Q 10 WDL2.5S	24 A	20	1071800000
Width			
WAP WDL2.5/S	1.5 mm	20	1067700000
WHP WDL2.5/S BL	1.5 mm	20	1067980000
WEW 35/2			
WEW 35/2	8 mm	100	1061200000
SWIFTY SET			
SWIFTY SET		1	9006060000
SD 0.6x3.5x100		1	9008330000
SSCH 10X3X1000 CU/SN			
SSCH 10X3X1000 CU/SN	10 mm	1	0348900000
ZB 4			
ZB 4	5.6 mm	50	0316500000
ZB 16 ZKSC	10 mm	50	0316600000
ZB 35/M6X16	14 mm	20	0266500000

WDL 2.5/S/N/L/PE

2.5 mm²

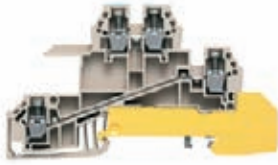

6.1 x 84.5 x 49
32 / 4
0.13...4

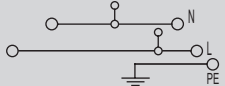

IEC 60947-7-1 (-7-2)

IEC	UL	CSA
400	300	300
24	15	10
2.5	AWG 22...12	AWG 26...12
4 / 3		
A3 / V-0		



Rated connection

0.5...4 / 1.5...4
0.5...4 / 0.5...2.5
0.4...0.6 Nm (M 2.5)
8 / 0.6 x 3.5 mm

L-PE / L-N 250 V

Type	Qty	Order No.
WDL 2.5/S/N/L/PE	50	1030700000
PE connection marked green/yellow		

Type	current	Qty	Order No.
Q 2 WDL2.5S	24 A	50	1071500000
Q 3 WDL2.5S	24 A	50	1071600000
Q 4 WDL2.5S	24 A	50	1071700000
Q 10 WDL2.5S	24 A	20	1071800000
Width			
WAP WDL2.5/S	1.5 mm	20	1067700000
WHP WDL2.5/S BL	1.5 mm	20	1067980000
WEW 35/2	8 mm	100	1061200000
SWIFTY SET		1	9006060000
SD 0.6x3.5x100		1	9008330000
SSCH 10X3X1000 CU/SN	10 mm	1	0348900000
ZB 4	5.6 mm	50	0316500000
ZB 16 ZKSC	10 mm	50	0316600000
ZB 35/M6X16	14 mm	20	0266500000

DEK 5/6 / WS 8/5

WDL 2.5/S/L/L/PE

2.5 mm²

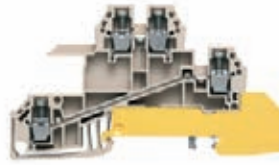

6.1 x 84.5 x 49
32 / 4
0.13...4

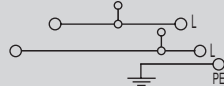

IEC 60947-7-1 (-7-2)

IEC	UL	CSA
400	300	300
24	15	10
2.5	AWG 22...12	AWG 26...12
4 / 3		
A3 / V-0		



Rated connection

0.5...4 / 1.5...4
0.5...4 / 0.5...2.5
0.4...0.6 Nm (M 2.5)
8 / 0.6 x 3.5 mm

L-PE 250 V

Type	Qty	Order No.
WDL 2.5/S/L/L/PE	50	1031100000
PE connection marked green/yellow		

Type	current	Qty	Order No.
Q 2 WDL2.5S	24 A	50	1071500000
Q 3 WDL2.5S	24 A	50	1071600000
Q 4 WDL2.5S	24 A	50	1071700000
Q 10 WDL2.5S	24 A	20	1071800000
Width			
WAP WDL2.5/S	1.5 mm	20	1067700000
WHP WDL2.5/S BL	1.5 mm	20	1067980000
WEW 35/2	8 mm	100	1061200000
SWIFTY SET		1	9006060000
SD 0.6x3.5x100		1	9008330000
SSCH 10X3X1000 CU/SN	10 mm	1	0348900000
ZB 4	5.6 mm	50	0316500000
ZB 16 ZKSC	10 mm	50	0316600000
ZB 35/M6X16	14 mm	20	0266500000

DEK 5/6 / WS 8/5

WDL 2.5/S/L

2.5 mm²



6.1 x 84.5 x 49
32 / 4
0.13...4

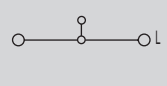

IEC 60947-7-1

IEC	UL	CSA
400	300	300
24	15	10
2.5	AWG 22...12	AWG 26...12
6 / 3		
A3 / V-0		



Rated connection

0.5...4 / 1.5...4
0.5...4 / 0.5...2.5
0.4...0.6 Nm (M 2.5)
8 / 0.6 x 3.5 mm

Type	Qty	Order No.
WDL 2.5/S/L	50	1031300000
WDL 2.5/S/N order no. 1031300000 (connection marked blue)		

Type	current	Qty	Order No.
Q 2 WDL2.5S	24 A	50	1071500000
Q 3 WDL2.5S	24 A	50	1071600000
Q 4 WDL2.5S	24 A	50	1071700000
Q 10 WDL2.5S	24 A	20	1071800000
Width			
WAP WDL2.5/S	1.5 mm	20	1067700000
WHP WDL2.5/S BL	1.5 mm	20	1067980000
WEW 35/2	8 mm	100	1061200000
SWIFTY SET		1	9006060000
SD 0.6x3.5x100		1	9008330000
SSCH 10X3X1000 CU/SN	10 mm	1	0348900000
ZB 4	5.6 mm	50	0316500000
ZB 16 ZKSC	10 mm	50	0316600000
ZB 35/M6X16	14 mm	20	0266500000

DEK 5/6 / WS 8/5

Installation terminals

Neutral conductor disconnect terminals

These special modular terminals are specified for insulation measurements without disconnecting the conductor according to VDE standards for places of public assembly.

In hazardous area applications, the installation instructions and the rated data specifications for accessories given in the technical appendix must be followed.

Width/Length/height with TS35x7.5	mm
max. current / max. cond. cross-section	A/mm ²
Max. clamping range	mm ²

Technical data

Rated data	
Rated voltage	V
Rated current	A
Rated cross-section	mm ²
Rated impulse voltage / Pollution severity	kV/-
Gauge to IEC 60947-1 / UL94 Flammability class	
Approvals	
Clamped conductors (H05V/H07V)	
solid / stranded	mm ²
flexible / Stranded wire with end ferrules	mm ²
Tightening torque range (clamping screw)	
Stripping length / Blade size	mm/-
Note	

Ordering data

Version	
	Dark beige Wemid
	Blue Wemid
Note	

Accessories

End plate / partition	
	Dark beige Wemid
	Blue Wemid
Mounting plate for 10 x 3 (required every 20 cm)	
	Blue Wemid
End bracket	
	Dark beige Wemid
Screwdriver	
	with „swifty set“ cutting device
	Standard
Busbar 10 x 3 (140 A)	
	OK, Busbar up to OK, TS35 = 25,5 mm
Clamping yoke for power supply to 10 x 3 busbars	
	Rigid / flexible 0,5 - 6 / 4 mm ²
	rigid / flexible 6 - 16 mm ²
	Flexible 16 - 35 mm ²



Marking systems	
	(see assortment in catalogue 7)
	Marking tags
For detailed information on other accessories and applications, refer to the „Accessories“ section	

WNT 2.5

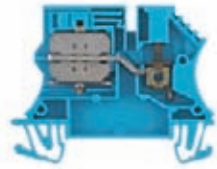
2.5 mm²

5.1 x 60 x 47
32 / 4
0.13...4



IEC 60947-7-1

IEC	UL	CSA
400	600	600
24	25	20
2.5	AWG 22...12	AWG 26...12
6 / 3		
A3 / V-0		

Rated connection

0.5...4 / 1.5...4
0.5...4 / 0.5...2.5
0.4...0.6 Nm (M 2.5)
10 / 0.6 x 3.5 mm

Tightening torque, N-disconnector 0.4...0.6 Nm

Type	Qty	Order No.
WNT 2.5 10X3 BE	100	1010600000
WNT 2.5 10X3	100	1010680000
2.5 mm ² conductor with wire end ferrule plus plastic collar only with collar optimised for diameter (order No. 1333100000, 500 pcs)		

Type	Width	Qty	Order No.
WAP 2.5-10	1.5 mm	50	1050000000
WAP 2.5-10 BL	1.5 mm	50	1050080000
WHP 2.5-35N/10x3 BL	2 mm	20	1050280000
WEW 35/2	8 mm	100	1061200000
SWIFTY SET		1	9006060000
SD 0.6x3.5x100		1	9008330000
SSCH 10X3X1000 CU/SN	10 mm	1	0348900000
ZB 4	5.6 mm	50	0316500000
ZB 16 ZKSC	10 mm	50	0316600000
ZB 35/M6X16	14 mm	20	0266500000

DEK 5/5 / WS 12/5

WNT 4

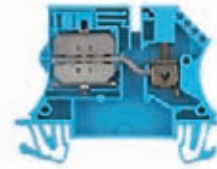
4 mm²

6.1 x 60 x 47
41 / 6
0.13...6



IEC 60947-7-1

IEC	UL	CSA
400	600	600
32	35	35
4	AWG 22...10	AWG 26...10
6 / 3		
A4 / V-0		

Rated connection

0.5...6 / 1.5...6
0.5...6 / 0.5...4
0.5...1.0 Nm (M 3)
10 / 0.6 x 3.5 mm

Tightening torque, N-disconnector 0.4...0.8 Nm

Type	Qty	Order No.
WNT 4 10X3 BE	100	1010700000
WNT 4 10X3	100	1010780000

Type	Width	Qty	Order No.
WAP 2.5-10	1.5 mm	50	1050000000
WAP 2.5-10 BL	1.5 mm	50	1050080000
WHP 2.5-35N/10x3 BL	2 mm	20	1050280000
WEW 35/2	8 mm	100	1061200000
SWIFTY SET		1	9006060000
SD 0.6x3.5x100		1	9008330000
SSCH 10X3X1000 CU/SN	10 mm	1	0348900000
ZB 4	5.6 mm	50	0316500000
ZB 16 ZKSC	10 mm	50	0316600000
ZB 35/M6X16	14 mm	20	0266500000

DEK 5/5 / WS 12/5

WNT 6

6 mm²



7.9 x 60 x 47
57 / 10
0.5...10



IEC 60947-7-1

IEC	UL	CSA
400	600	600
41	45	45
6	AWG 20...8	AWG 20...8
6 / 3		
A5 / V-0		

Rated connection

0.5...10 / 1.5...10
0.5...10 / 0.5...6
0.8...1.2 Nm (M 3.5)
12 / 4.0 x 0.8 mm

Tightening torque, N-disconnector 0.8...1.6 Nm

Type	Qty	Order No.
WNT 6 10X3 BE	50	1010800000
WNT 6 10X3	50	1010880000

Type	Width	Qty	Order No.
WAP 2.5-10	1.5 mm	50	1050000000
WAP 2.5-10 BL	1.5 mm	50	1050080000
WHP 2.5-35N/10x3 BL	2 mm	20	1050280000
WEW 35/2	8 mm	100	1061200000
SWIFTY SET		1	9006060000
SD 0.6x3.5x100		1	9008330000
SSCH 10X3X1000 CU/SN	10 mm	1	0348900000
ZB 4	5.6 mm	50	0316500000
ZB 16 ZKSC	10 mm	50	0316600000
ZB 35/M6X16	14 mm	20	0266500000

DEK 5/5 / WS 12/5

WNT 10

10 mm²



9.9 x 60 x 47
76 / 16
1.31...16



IEC 60947-7-1

IEC	UL	CSA
400	600	600
57	60	65
10	AWG 16...6	AWG 16...6
6 / 3		
B6 / V-0		

Rated connection

1.5...16 / 1.5...16
1.5...16 / 1.5...16
1.2...2.0 Nm (M 4)
12 / 1.0 x 5.5 mm

Tightening torque, N-disconnector 0.8...1.6 Nm. AWG 6/7 and H07V-R25 conductors require a tightening torque of 1.5 Nm.

Type	Qty	Order No.
WNT 10 10X3 BE	50	1010900000
WNT 10 10X3	50	1010980000

Type	Width	Qty	Order No.
WAP 2.5-10	1.5 mm	50	1050000000
WAP 2.5-10 BL	1.5 mm	50	1050080000
WHP 2.5-35N/10x3 BL	2 mm	20	1050280000
WEW 35/2	8 mm	100	1061200000
SWIFTY SET		1	9006060000
SD 0.6x3.5x100		1	9008330000
SSCH 10X3X1000 CU/SN	10 mm	1	0348900000
ZB 4	5.6 mm	50	0316500000
ZB 16 ZKSC	10 mm	50	0316600000
ZB 35/M6X16	14 mm	20	0266500000

DEK 5/5 / WS 12/5

WNT 16N

16 mm²



12 x 60 x 47
101 / 25
1.5...25



IEC 60947-7-1

IEC	UL	CSA
400	300	300
76	65	65
16	AWG 14...6	AWG 14...6
6 / 3		
B7 / V-0		

Rated connection

1.5...16 / 1.5...25
1.5...16 / 1.5...16
1.2...2.2 Nm (M 4)
12 / 1.0 x 5.5 mm

Tightening torque, N-disconnector 0.8...1.6 Nm. AWG 6/7 and H07V-R25 conductors require a tightening torque of 1.5 Nm.

Type	Qty	Order No.
WNT 16N 10X3	50	1019000000

Type	Width	Qty	Order No.
WHP 2.5-35N/10x3 BL	2 mm	20	1050280000
WEW 35/2	8 mm	100	1061200000
SWIFTY SET		1	9006060000
SD 1.0x5.5x150		1	9008350000
SSCH 10X3X1000 CU/SN	10 mm	1	0348900000
ZB 4	5.6 mm	50	0316500000
ZB 16 ZKSC	10 mm	50	0316600000
ZB 35/M6X16	14 mm	20	0266500000

DEK 5/5 / WS 12/6,5

Installation terminals

Neutral conductor disconnect terminals

These special modular terminals are specified for insulation measurements without disconnecting the conductor according to VDE standards for places of public assembly.

In hazardous area applications, the installation instructions and the rated data specifications for accessories given in the technical appendix must be followed.

Width/Length/height with TS35x7.5	mm
max. current / max. cond. cross-section	A/mm ²
Max. clamping range	mm ²

Technical data

Rated data

Rated voltage	V
Rated current	A
Rated cross-section	mm ²
Rated impulse voltage / Pollution severity	kV/-
Gauge to IEC 60947-1 / UL94 Flammability class	
Approvals	

Clamped conductors (H05V/H07V)

solid / stranded	mm ²
flexible / Stranded wire with end ferrules	mm ²
Tightening torque range (clamping screw)	
Stripping length / Blade size	mm/-

Note

Ordering data

Version

Dark beige Wemid
Blue Wemid

Note

Accessories

End plate / partition

Dark beige Wemid
Blue Wemid

Mounting plate for 10 x 3 (required every 20 cm)

Blue Wemid



End bracket

Dark beige Wemid

Screwdriver

with „swifty set“ cutting device
Standard

Busbar 10 x 3 (140 A)

OK, Busbar up to OK, TS35 = 25,5 mm

Clamping yoke for power supply to 10 x 3 busbars

Rigid / flexible 0,5 - 6 / 4 mm²
rigid / flexible 6 - 16 mm²
Flexible 16 - 35 mm²



Marking systems

(see assortment in catalogue 7)

Marking tags

For detailed information on other accessories and applications, refer to the „Accessories“ section

WNT 35N

35 mm²

Compact design



16 x 66 x 51

150 / 50

2.5...50



IEC 60947-7-1

IEC	UL	CSA
400		
125		
35		
	6 / 3	
	B8 / V-0	



Rated connection

2.5...16 / 2.5...50
2.5...35 / 2.5...35
4.0...5.0 Nm (M 6)
18 / 6.5 x 1.2 mm

The tightening torque for 16 - 50 mm² stranded conductors is 4.5 Nm.
Tightening torque for N-isolator: 1.2...2.4 Nm

Type	Qty	Order No.
WNT 35N 10X3	20	1718550000

Type	Width	Qty	Order No.
WHP 2.5-35N/10x3 BL	2 mm	20	1050280000
WEW 35/2	8 mm	100	1061200000
SWIFTY SET		1	9006060000
SD 1.0x5.5x150		1	9008350000
SSCH 10X3X1000 CU/SN	10 mm	1	0348900000
ZB 4	5.6 mm	50	0316500000
ZB 16 ZKSC	10 mm	50	0316600000
ZB 35/M6X16	14 mm	20	0266500000

DEK 5/5 / WS 12/6,5

Refer to the „W-Series Accessories“ section for PEN bridges.

WNT 70N

70 mm²

Compact design



20.5 x 75 x 86

207 / 95

10...95



IEC 60947-7-1

IEC	UL	CSA
400	600	
192	175	
70	AWG 6...2/0	
	6 / 3	
	B11 / V-0	



Rated connection

10...16 / 10...95
10...70 / 10...70
6.0...12 Nm (M 8)
22 / S6 (DIN 6911)

Tightening torque, N-disconnector 2.5...5.0 Nm

Type	Qty	Order No.
WNT 70N/35	10	9512210000

Type	Width	Qty	Order No.
WHP 2.5-35N/10x3 BL	2 mm	20	1050280000
WEW 35/2	8 mm	100	1061200000
SWIFTY SET		1	9006060000
SD 1.0x5.5x150		1	9008350000
SSCH 10X3X1000 CU/SN	10 mm	1	0348900000
ZB 4	5.6 mm	50	0316500000
ZB 16 ZKSC	10 mm	50	0316600000
ZB 35/M6X16	14 mm	20	0266500000

DEK 5/5 / WS 12/6,5

Test-disconnect terminals

Testing made easy

WTL 6/1 EN, WTD 6/1 EN, WTQ 6/1 EN

Current transformers may only be short-circuited or operated with a negligible load impedance because open current transformers “run hot” and destroy themselves. Apart from that, load impedances lead to measuring inaccuracies in electricity supply meters and hence to financial losses for their operators.

You can solve many switching tasks - clearly and affordably - with the WTL 6/1 EN test-disconnect terminal, the WTD 6/1 EN feed-through terminal, and the WTQ 6/1 EN cross-disconnect terminal.

E

The screws for connecting the conductors are only accessible after the current transformer has been short-circuited with the help of the short-circuit slider. This guarantees that the measuring instrument is not accidentally disconnected.

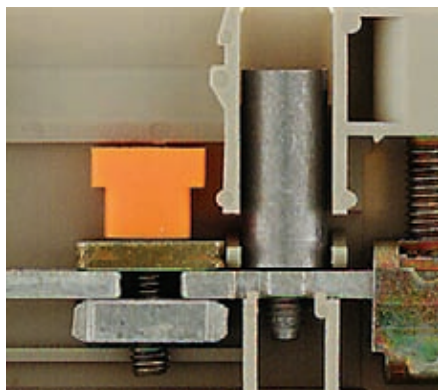
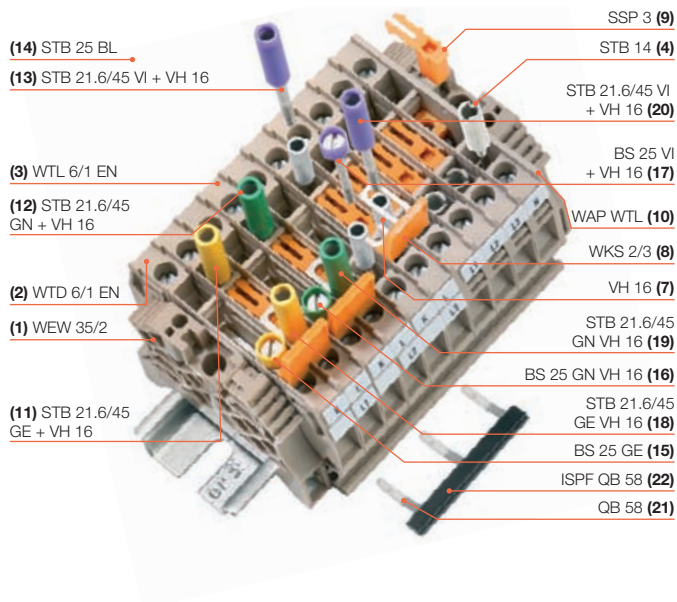

Sliding disconnecter is easy to use (WTL 6/1 EN)



Safe disconnection of cross-connection (WTQ 6/1 EN)

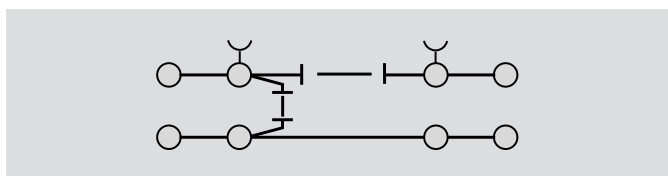

One short-circuit slider per terminal (WTL 6/1 EN)

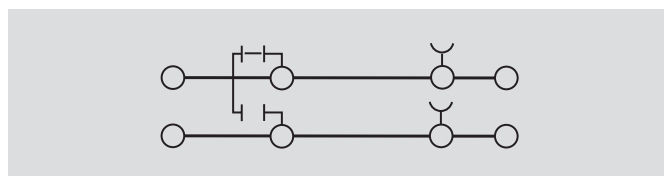

One short-circuit jumper per terminal (WTQ 6/1 EN)

Test-disconnect terminal blocks for metering with the WTL 6/1 EN

Ordering data

Pos.	Type	Order No.	Order No.	Qty.
1	WEW35/2/EWK1	1061200000	0206160000	2
2	WTD 6/1 EN	1934830000	1934830000	3
3	WTL 6/1 EN	1934810000	1934810000	7
4	STB 14	0169900000	0169900000	4
5	BS 25 SW ¹⁾	0335200000	0335200000	3
6	STB 35 SW ²⁾	0388500000	0388500000	3
7	VH 16	0309700000	0309700000	9
8	WKS 2/3	1936140000	1936140000	3
9	SSP 3	0531760000	0531760000	7
10	WAP WTL	1068300000	1068300000	1

¹⁾ Pos. 5 similar to pos. 15, but with black insulating sleeve / ²⁾ Item 6 similar to item 18, but with black insulating sleeve

Optionally available for better labelling (instead of 8 x pos. 4, 3 x pos. 5 and 3 x pos. 6):

Pos.	Type	Order No.	Order No.	Qty.
4	STB 14	0169900000	0169900000	4
11	STB 21.6/45 GE	1936240000	1936240000	2
12	STB 21.6/45 GN	1936250000	1936250000	2
13	STB 21.6/45 VI	1936260000	1936260000	2
15	BS 25 GE	0335700000	0335700000	1
16	BS 25 GN	0335600000	0335600000	1
17	BS 25 VI	0335800000	0335800000	1

Additionally available for a shared k-point:

Pos.	Type	Order No.	Order No.	Qty.
21	QB 58° angled	0545300000	0545300000	1
22	ISPFQB58SW*	0546000000	0546000000	1

* Shorten to 5 poles

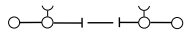

WTL 6/1 EN/STB

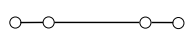
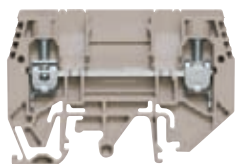

WTD 6/1 EN

Operating status

(with external distribution of k-point)

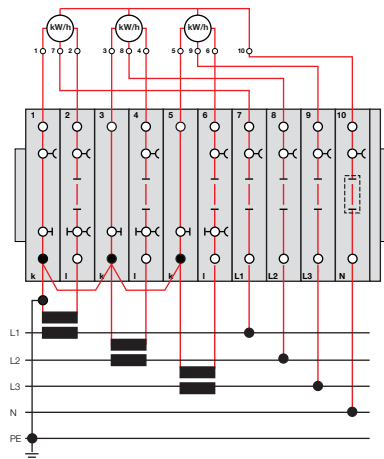

Comparison measurement for L1

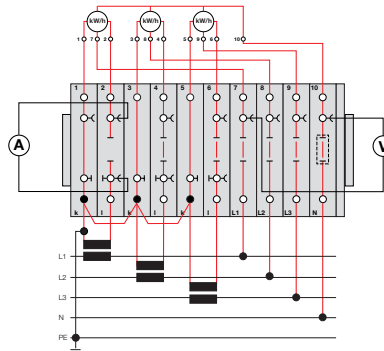

Operation depending on operating status:

1. Connect ammeter to test sockets at terminal 2.
2. Open disconnect slide link of terminals 2.
3. Connect voltmeter to test sockets of terminals 7 and 10.

Meter test for L1 through external power supply

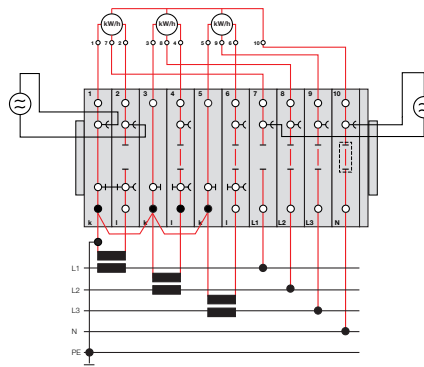

Operation depending on operating status:

1. Close the short-circuit slide of the terminals 1 and 2.
2. Open disconnect slide link of the terminals 2 and 7.
3. Connect external power supply to test sockets of terminals 1, 2 and 7, 10.

Changing the meter for L1

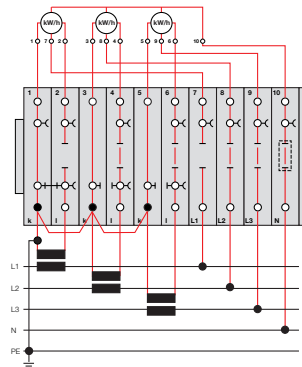

Operation depending on operating status:

1. Close short-circuit slide of the terminals 1 and 2.
2. Open disconnect slide link of the terminals 2 and 7.
3. Disconnect meter for L1 at the terminals 1, 2 and 7.

Test-disconnect terminals

Convenient test-disconnect terminals WTL 6/2, WTL 6/3

All the circuits occurring in practice can be realised with the WTL 6/2 and WTL 6/3 terminals plus a few accessories.

The short-circuit sliders are finger-touch safe – no risk of electric shock. Two cross-connections, e.g. for internal distribution of the contact point, can also be incorporated. The standard WQV 6/... cross-connections of the W-Series can be used here, which also permit terminals to be bypassed.

Thanks to the specially designed test sockets, both conventional test plugs and conventional safety test plugs can be used with the WTL 6/3.

Another advantage of the WTL 6/3 is that one screwdriver fits all screws and also all sockets.

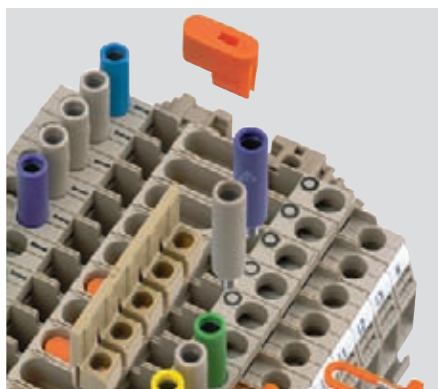
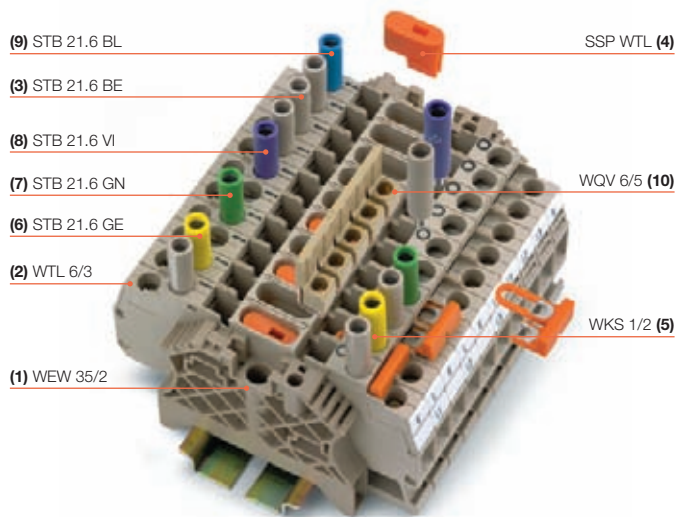

Optimised accessories for all circuit variations

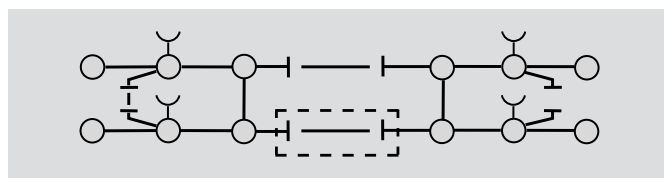

Variation with maximum accessories

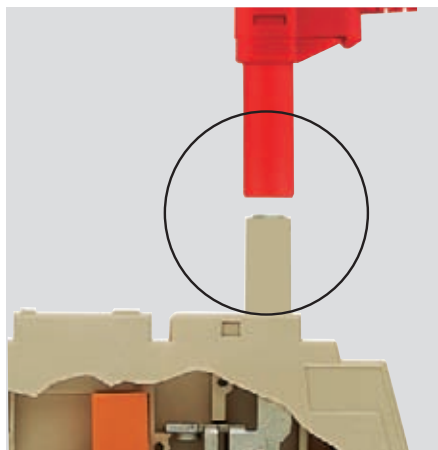

Safe test point to German standard

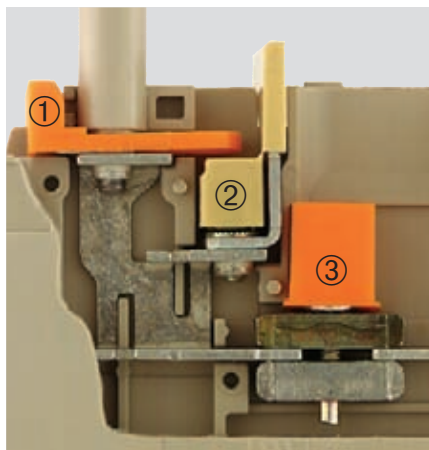

Compact design: ① sliding disconnect, ② cross-connection, ③ short-circuit slider



2 DEK markers per connection point

Test-disconnect terminal blocks for measuring with WTL 6/3

Ordering data

Pos.	Type	Order No.	Order No.	Qty.
1	WEW35/2/EWK1	1061200000	0206160000	2
2	WTL 6/3	1018800000	1018900000	10
3	STB 21.6 BE	1071000000	1071000000	14
4	SSP WTL	1604200000	1604200000	4
5	WKS 1/2	1604270000	1604270000	3

Optionally available for better labelling for WTL 6/3 (instead of 14 x pos. 3):

Pos.	Type	Order No.	Order No.	Qty.
3	STB 21.6 BE	1071000000	1071000000	7
6	STB 21.6 GE	1071010000	1071010000	2
7	STB 21.6 GN	1071020000	1071020000	2
8	STB 21.6 VI	1071030000	1071030000	2
9	STB 21.6 BL	1071080000	1071080000	1

Additionally available for a shared k-point:

Pos.	Type	Order No.	Order No.	Qty.
10	WQV 6/5	1062660000	1062660000	1

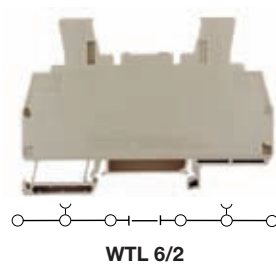
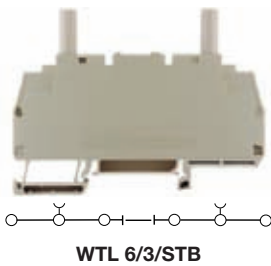

The disconnect test terminal WTL 6/3/STB offers the same functionality as the WTL 6/2. However, thanks to the special design of the test sockets both conventional test plugs as well as commercially available test plugs can be used.

Operating status

(with internal distribution of the k-point)

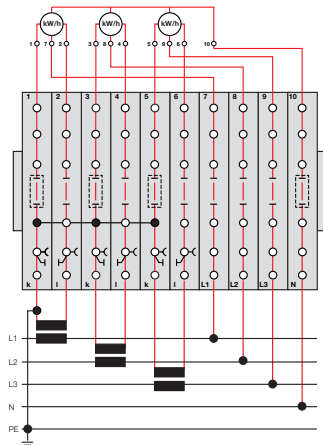

Comparison measurement for L1

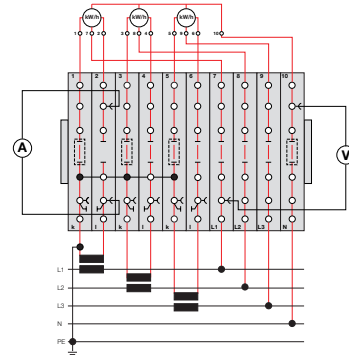

Operation depending on the operating status:

1. Connect ammeter to test sockets of terminal 2.
2. Open disconnect slide link of terminal 2.
3. Connect voltmeter to test sockets of terminals 7 and 10.

Meter test for L1 through external power supply

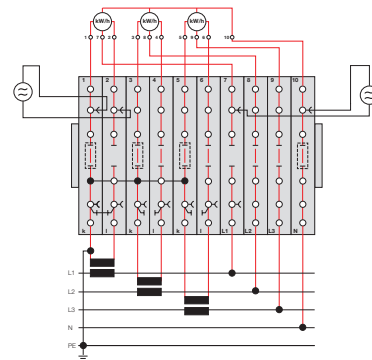

Operation depending on the operating status:

1. Close short-circuit slide of terminals 1 and 2.
2. Open disconnect slide link of terminals 2 and 7.
3. Connect external power supply to the sockets of terminals 1, 2 and 7, 10.

Changing the meter for L1

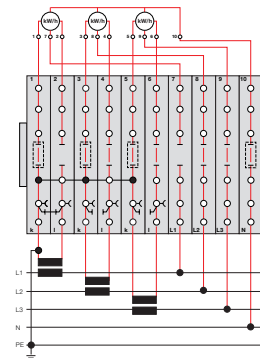

Operation depending on the operating status:

1. Close short-circuit slide of terminals 1 and 2.
2. Open disconnect slide link of terminals 2 and 7.
3. Disconnect meter for L1 at terminals 1, 2 and 7.

Test-disconnect terminals

Different current transformer circuits, e.g. for replacing measuring instruments or electricity meters, can be realised.

In hazardous area applications, the installation instructions and the rated data specifications for accessories given in the technical appendix must be followed.

Width/Length/height with TS35x7.5	mm
max. current / max. cond. cross-section	A/mm ²
Max. clamping range	mm ²

Technical data

Rated data	
Rated voltage	V
Rated current	A
Rated cross-section	mm ²
Rated impulse voltage / Pollution severity	kV/-
Gauge to IEC 60947-1 / UL94 Flammability class	
Approvals	
Clamped conductors (H05V/H07V)	
solid / stranded	mm ²
flexible / Stranded wire with end ferrules	mm ²
Tightening torque range (clamping screw)	
Stripping length / Blade size	mm/-
Note	

Ordering data

Version	
	With socket
	Without socket
Note	

Accessories

Screwable cross-connection	
	2-pole
	3-pole
	4-pole
	10-pole
Connecting sleeve for cross-connector QL	
Mounting screw	
End plate / partition	
	Dark beige Wemid
	Dark beige Wemid
Cross-connection slider	
	2-pole
	3-pole
	4-pole
Connecting sleeve for QVS	
Mounting screw for QVS	
Testing / Checking	
	Test plug
	Socket, grey
	Socket, green
	Socket, violet
	Socket, blue
	Socket
Miscellaneous accessories	

Marking systems	
	(see assortment in catalogue 7)
	Marking tags

For detailed information on other accessories and applications, refer to the „Accessories“ section

WTL 4

4 mm²

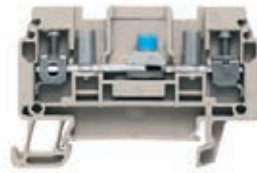

6.1 x 61.3 x 40.7

41 / 6

0.13...6

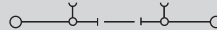

IEC 60947-7-1

IEC	UL	CSA
500	300	300
32	28	28
4	AWG 26...10	AWG 26...10
6 / 3		
A3 / V-0		



Rated connection

0.5...6 / 1.5...4
0.5...4 / 0.5...4
0.4...0.7 Nm (M 2.5)
10 / 0.6 x 3.5 mm

Usage as disconnect terminal with 400 V.

Type	Qty	Order No.
WTL 4/STB	50	1754970000
WTL 4	50	1754960000

Type	current	Qty	Order No.
WQV 4/2	32 A	50	1051960000
WQV 4/3	32 A	50	1054560000
WQV 4/4	32 A	50	1054660000
WQV 4/10	41 A	20	1052060000

Width	
ZAP/TW 1	2 mm 50 1608740000

current	
QVS 2/4 SAKT4	32 A 20 1319260000

VH 16/5/3.5 SAK10-35	50	0309700000
BFSC M3X22 SAKT4	50	1319900000

Width	
PS 4 F.STB 4	7.6 mm 20 0299600000

STB 8.5/5/2.3/M3 SAK2.5	50	0280600000
-------------------------	----	------------

DEK 5/6 / WS 12/6

WTL 4/2

4 mm²

Enforced short-circuit function

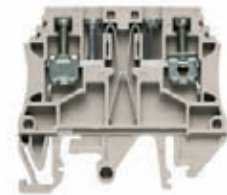

6 x 56.5 x 50

11 / 6

0.13...6

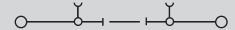

IEC 60947-7-1

IEC	UL	CSA
500		
10		
4		
6 / 3		
A4 / V-0		



Rated connection

0.5...6 / 1.5...6
0.5...6 / 0.5...4
0.5...0.8 Nm (M 3)
10 / 0.6 x 3.5 mm

2 conductors can be connected, similar to WDU 4N.

Type	Qty	Order No.
WTL 4/2 STB	50	1881650000

Type	Qty	Order No.

Width	
WAP WTL4/2	50 1881640000

current	

WS 12/6

WTA 8-Series test adapter, WQV external cross-connection, end bracket and shield bus LS 2.8, refer to „Accessories“

WTL 6/1 EN

6 mm²

Longitudinal - disconnect

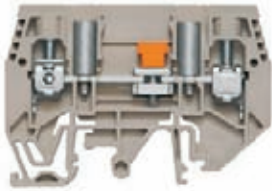

7.9 x 65 x 48.5

57 / 10

0.5...10

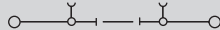

IEC 60947-7-1

IEC	UL	CSA
630	300	300
41	45	45
6	AWG 20...8	AWG 20...8
6 / 3		
A5 / V-0		



Rated connection

0.5...10 / 1.5...10

0.5...10 / 0.5...6

0.8...1.6 Nm (M 3.5)

12 / 4.0 x 0.8 mm

Use as 500 V disconnect terminal. Conductor connection H07V-K10, H07V-R10 and AWG 8/7 with tightening torque of 1.0 Nm.

Type	Qty	Order No.
WTL 6/1 EN STB	50	1934820000
WTL 6/1 EN	50	1934810000
TS32 version on request		

Type	current	Qty	Order No.
QL 2 SAK6N	32 A	50	0194300000
QL 3 SAK6N	57 A	50	0194400000
QL 4 SAK6N	57 A	50	0194500000
QL 10 SAK6N	32 A	20	0338300000
VH 12/4.9/3.3 SAK6N		100	0249000000
KISC M3X20 SAK10 CU5		100	0377100000
Width			
WAP WTL6/1 L	1.5 mm	20	1957710000
WTW WTL6/1 DB	1.5 mm	20	1068400000
current			
QVS 2 SAKT1+2	41 A	20	0307300000
QVS 3 SAKT1+2	41 A	20	0329300000
QVS 4 SAKT1+2	41 A	20	0307400000
VH 16		50	0309700000
STB 21.6/45		50	1936240000
Width			
PS 4 F.STB 4	7.6 mm	20	0299600000
STB 35 IH/GE		50	0389000000
STB 35 IH/GN		50	0388900000
STB 35 IH/VI		50	0389100000
STB 35 IH/BL		50	0388700000
STB 14/D6/4/M3 SAK10		50	0169900000

DEK 5/8 / WS 12/6,5

WTD 6/1 EN

6 mm²

Feed-through

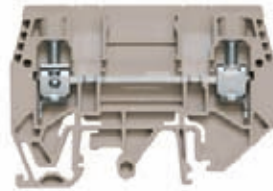

7.9 x 65 x 48.5

57 / 10

0.5...10

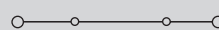

IEC 60947-7-1

IEC	UL	CSA
630	300	300
41	45	45
6	AWG 20...8	AWG 20...8
6 / 3		
A5 / V-0		



Rated connection

0.5...10 / 1.5...10

0.5...10 / 0.5...6

0.8...1.6 Nm (M 3.5)

12 / 4.0 x 0.8 mm

Conductor connection H07V-K10, H07V-R10 and AWG 8/7 with tightening torque of 1.0 Nm.

Type	Qty	Order No.
WTD 6/1 EN	50	1934830000
TS32 version on request		

Type	current	Qty	Order No.
QL 2 SAK6N	32 A	50	0194300000
QL 3 SAK6N	57 A	50	0194400000
QL 4 SAK6N	57 A	50	0194500000
QL 10 SAK6N	32 A	20	0338300000
VH 12/4.9/3.3 SAK6N		100	0249000000
KISC M3X20 SAK10 CU5		100	0377100000
Width			
WAP WTL6/1 L	1.5 mm	20	1957710000
WTW WTL6/1 DB	1.5 mm	20	1068400000
current			
QVS 2 SAKT1+2	41 A	20	0307300000
QVS 3 SAKT1+2	41 A	20	0329300000
QVS 4 SAKT1+2	41 A	20	0307400000
VH 16		50	0309700000
STB 21.6/45		50	1936240000
Width			
PS 4 F.STB 4	7.6 mm	20	0299600000
STB 35 IH/GE		50	0389000000
STB 35 IH/GN		50	0388900000
STB 35 IH/VI		50	0389100000
STB 35 IH/BL		50	0388700000
STB 14/D6/4/M3 SAK10		50	0169900000

DEK 5/8 / WS 12/6,5

WTQ 6/1 EN

6 mm²

Cross-connect/disconnect (isolator)

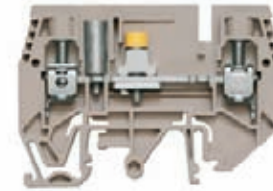

7.9 x 65 x 48.5

57 / 10

0.5...10



IEC 60947-7-1

IEC	UL	CSA
500	300	300
41	45	45
6	AWG 20...8	AWG 20...8
6 / 3		
A5 / V-0		



Rated connection

0.5...10 / 1.5...

0.5...10 / 0.5...6

0.8...1.6 Nm (M 3.5)

12 / 4.0 x 0.8 mm

Conductor connection H07V-K10, H07V-R10 and AWG 8/7 with tightening torque of 1.0 Nm.

Type	Qty	Order No.
WTQ 6/1 EN STB	50	1934800000
WTQ 6/1 EN	50	1934790000
TS32 version on request		

Type	current	Qty	Order No.
QL 2 SAK6N	32 A	50	0194300000
QL 3 SAK6N	57 A	50	0194400000
QL 4 SAK6N	57 A	50	0194500000
QL 10 SAK6N	32 A	20	0338300000
VH 12/4.9/3.3 SAK6N		100	0249000000
KISC M3X20 SAK10 CU5		100	0377100000
Width			
WAP WTL6/1	1.5 mm	20	1068300000
WTW WTL6/1 DB	1.5 mm	20	1068400000
current			
WKB 1/2		50	1604280000
WKB 1/3		50	1604300000
WKB 1/4		50	1604320000
Width			
PS 4 F.STB 4	7.6 mm	20	0299600000
STB 35 IH/GE		50	0389000000
STB 35 IH/GN		50	0388900000
STB 35 IH/VI		50	0389100000
STB 35 IH/BL		50	0388700000
STB 14/D6/4/M3 SAK10		50	0169900000

DEK 5/8 / WS 12/6,5

Test-disconnect terminals

Different current transformer circuits, e.g. for replacing measuring instruments or electricity meters, can be realised.

In hazardous area applications, the installation instructions and the rated data specifications for accessories given in the technical appendix must be followed.

Width/Length/height with TS35x7.5	mm
max. current / max. cond. cross-section	A/mm ²
Max. clamping range	mm ²



Technical data

Rated data	
Rated voltage	V
Rated current	A
Rated cross-section	mm ²
Rated impulse voltage / Pollution severity	kV/-
Gauge to IEC 60947-1 / UL94 Flammability class	
Approvals	
Clamped conductors (H05V/H07V)	
solid / stranded	mm ²
flexible / Stranded wire with end ferrules	mm ²
Tightening torque range (clamping screw)	
Stripping length / Blade size	mm/-
Note	

Ordering data

Version	
	With socket
	Without socket
Note	

Accessories

Screwable cross-connection	
	2-pole
	3-pole
	4-pole
	10-pole
	Connecting sleeve for cross-connector QL
	Mounting screw
End plate / partition	
	Dark beige Wemid
	Dark beige Wemid
Cross-connection slider	
	2-pole
	3-pole
	4-pole
	Connecting sleeve for QVS
	Mounting screw for QVS
Testing / Checking	
	Test plug
	Socket, grey
	Socket, green
	Socket, violet
	Socket, blue
	Socket
Miscellaneous accessories	

Marking systems	
	(see assortment in catalogue 7)
	Marking tags
For detailed information on other accessories and applications, refer to the „Accessories“ section	

WTL 6/1/STB/TNSC/EN

6 mm²

Longitudinal - disconnect

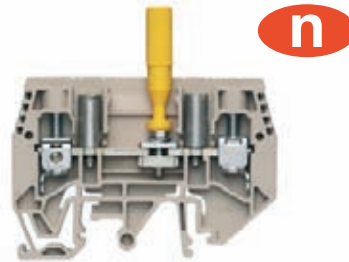

7.9 x 65 x 48.5	
57 / 10	
0.5...10	

IEC 60947-7-1		
IEC	UL	CSA
630	300	300
41	45	45
6	AWG 20...8	AWG 20...8
6 / 3		
A5 / V-0		
UL		
Rated connection		
0.5...10 / 1.5...		
0.5...10 / 0.5...6		
0.8...1.6 Nm (M 3.5)		
12 / 4.0 x 0.8 mm		
Use as 500 V disconnect terminal. Conductor connection H07V-K10, H07V-R10 and AWG 8/7 with tightening torque of 1.0 Nm.		

Type	Qty	Order No.
WTL 6/1/STB/TNSC/EN	50	1938820000
TS32 version on request		

Type	current	Qty	Order No.
QL 2 SAK6N	32 A	50	0194300000
QL 3 SAK6N	57 A	50	0194400000
QL 4 SAK6N	57 A	50	0194500000
QL 10 SAK6N	32 A	20	0338300000
VH 12/4.9/3.3 SAK6N		100	0249000000
KISC M3X20 SAK10 CU5		100	0377100000
Width			
WAP WTL6/1	1.5 mm	20	1068300000
WTW WTL6/1 DB	1.5 mm	20	1068400000
current			
QVS 2 SAKT1+2	41 A	20	0307300000
QVS 3 SAKT1+2	41 A	20	0329300000
QVS 4 SAKT1+2	41 A	20	0307400000
VH 19/6/4.2 SAKT1		50	0318000000
BS 25 IH/GE SAKT1		50	0335700000
Width			
PS 4 F.STB 4	7.6 mm	20	0299600000
STB 35 IH/GE		50	0389000000
STB 35 IH/GN		50	0388900000
STB 35 IH/V		50	0389100000
STB 35 IH/BL		50	0388700000
STB 14/D6/4/M3 SAK10		50	0169900000

DEK 5/8 / WS 12/6,5

Different current transformer circuits, e.g. for replacing measuring instruments or electricity meters, can be realised.

In hazardous area applications, the installation instructions and the rated data specifications for accessories given in the technical appendix must be followed.

Width/Length/height with TS35x7.5	mm
max. current / max. cond. cross-section	A/mm ²
Max. clamping range	mm ²



Technical data

Rated data	
Rated voltage	V
Rated current	A
Rated cross-section	mm ²
Rated impulse voltage / Pollution severity	kV/-
Gauge to IEC 60947-1 / UL94 Flammability class	
Approvals	
Clamped conductors (H05V/H07V)	
solid / stranded	mm ²
flexible / Stranded wire with end ferrules	mm ²
Tightening torque range (clamping screw)	
Stripping length / Blade size	mm/-
Note	

Ordering data

Version	
	With socket
	Without socket
Note	

Accessories

Screwable cross-connection	
	2-pole
	3-pole
	4-pole
	10-pole
	Connecting sleeve for cross-connector QL
	Mounting screw
End plate / partition	
	Dark beige Wemid
	Dark beige Wemid
Cross-connection slider	
	2-pole
	3-pole
	4-pole
	Connecting sleeve for QVS
	Mounting screw for QVS
Testing / Checking	
	Test plug
	Socket, grey
	Socket, green
	Socket, violet
	Socket, blue
	Socket
Miscellaneous accessories	

Marking systems	
	(see assortment in catalogue 7)
	Marking tags
For detailed information on other accessories and applications, refer to the „Accessories“ section	

WTL 6/2

6 mm²

Longitudinal - disconnect

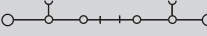

8 x 87 x 61.8	
57 / 10	
0.5...10	

IEC 60947-7-1		
IEC	UL	CSA
500	300	300
41	45	45
6	AWG 20...8	AWG 20...8
6 / 3		
A5 / V-0		
UL		
Rated connection		
0.5...10 / 1.5...10		
0.5...10 / 0.5...6		
0.8...1.6 Nm (M 3.5)		
12 / 4.0 x 0.8 mm		

Type	Qty	Order No.
WTL 6/2	50	1017700000
TS32 version on request		

Type	current	Qty	Order No.
WQV 6/2	57 A	50	1052360000
WQV 6/3	57 A	50	1054760000
WQV 6/4	57 A	50	1054860000
WQV 6/10	57 A	20	1052260000
Width			
PS 4 F.STB 4	7.6 mm	20	0299600000

WS 12/6,5	For further disconnect test terminal accessories, see chapter „Accessories“
-----------	---

WTL 6/3

6 mm²

Longitudinal - disconnect

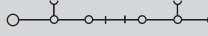

7.9 x 87 x 65	
57 / 10	
0.5...10	

IEC 60947-7-1		
IEC	UL	CSA
500	300	300
41	45	45
6	AWG 20...8	AWG 20...8
6 / 3		
A5 / V-0		
UL		
Rated connection		
0.5...10 / 1.5...10		
0.5...10 / 0.5...6		
0.8...1.6 Nm (M 3.5)		
12 / 4.0 x 0.8 mm		

Type	Qty	Order No.
WTL 6/3/STB	50	1018600000
WTL 6/3	50	1018800000
TS32 version on request		

Type	current	Qty	Order No.
WQV 6/2	57 A	50	1052360000
WQV 6/3	57 A	50	1054760000
WQV 6/4	57 A	50	1054860000
WQV 6/10	57 A	20	1052260000
Width			
PS 4 F.STB 4	7.6 mm	20	0299600000
STB 21.6/IH/GE WTL6/3	6.2 mm	50	1071010000
STB 21.6/IH/GN WTL6/3	6.2 mm	50	1071020000
STB 21.6/IH/VI WTL6/3	6.2 mm	50	1071030000
STB 21.6/IH/BL WTL6/3	6.2 mm	50	1071080000

DEK 5/8 / WS 12/6,5	For further disconnect test terminal accessories, see chapter „Accessories“
---------------------	---

Test-disconnect terminals

WTL 6/4 FF

Longitudinal disconnecter



Width x length x height mm
 max. current / max. cond. cross-section A/mm²
 max. clamping range mm²

11 x 76.5 x 52
 41 / 6
 0.13 ... 6

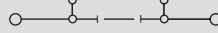

Technical data

Rated data	
Rated voltage	V
Rated current	A
Rated cross-section	mm ²
Tightening torque range, clamp. screw/disconnector	Nm
Approvals	
Note	

IEC 60947-7-1 / VDE 0100-537

IEC	UL	CSA	EN 50019
800	600	600	
500 V for use as test-disconnect terminal			
41	30	30	
6	AWG 26 ... 10	AWG 26 ... 10	
1.2 ... 1.9 / 0.5 ... 0.8			



WTD 6/4 FF

Feed-through terminal



11 x 76.5 x 52
 41 / 6
 0.13 ... 6

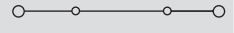

IEC 60947-7-1 / VDE 0100-537

IEC	UL	CSA	EN 50019
800	600	600	
500 V for use as test-disconnect terminal			
41	30	30	
6	AWG 26 ... 10	AWG 26 ... 10	
1.2 ... 1.9			



Ordering data

Version
Note

Type	Qty.	Order No.
WTL 6/4 FF	50	1887210000
insulated cable lug needed		

Type	Qty.	Order No.
WTD 6/4 FF	50	1887220000
insulated cable lug needed		

Accessories

Cross-connection
ZQV: plug-in cross-connection 2-pole 
End plate/partition plate
Wemid, dark beige
End bracket
Screw
Connecting sleeves
Cross-connection lugs
Cross-connection
Insulating sleeve
Cross-connection plug
Cable lug
Tools
Screwdriver
Crimping tools
Marking systems
Tags
For detailed information on further accessories and their use see chapter "Accessories".

Type	Qty.	Order No.
ZQV 10/2	25	1739680000
WAP WTL6/4FF	20	1887240000
EWK 1/TS 32	100	0206160000
WEW 35/2 / TS 35	100	1061200000
EW 35 /SCHA/M3	100	0258660000
BS M3x20		0303000000
BS M3x20 CuNi		0377100000
VH 13.5		0248500000
QL 2 WTL 6/4 FF		1897010000
QL 3 WTL 6/4 FF		1897020000
QL 4 WTL 6/4 FF		1897030000
QL 10 WTL 6/4 FF		1897090000
QL 50 WTL 6/4 FF		1897100000
Q 2 WTL 6/4 FF		1897110000
Q 3 WTL 6/4 FF		1897120000
Q 4 WTL 6/4 FF		1897130000
Q 10 WTL 6/4 FF		1897190000
DS 13.5 WTL 6/4		1897000000
QS 2 (2-pole)		0270760000
LIR 1.5 M4 V		9200090000
LIR 2.5 M4 V		9200170000
LIR 6 M4 V		9200230000
SDI 0.8 x 4.0		9008400000
SD 0.8 x 4.0		9008340000
SDIZ 0.8 x 5.5		9008640000
CTI 6		9006120000
WS 10/5 / DEK 5		
For additional test-disconnect terminal accessories, refer to the Accessories Chapter.		

Type	Qty.	Order No.
ZQV 10/2	25	1739680000
WAP WTL6/4FF	20	1887240000
EWK 1/TS 32	100	0206160000
WEW 35/2 / TS 35	100	1061200000
EW 35 /SCHA/M3	100	0258660000
BS M3x20		0303000000
BS M3x20 CuNi		0377100000
VH 13.5		0248500000
QL 2 WTL 6/4 FF		1897010000
QL 3 WTL 6/4 FF		1897020000
QL 4 WTL 6/4 FF		1897030000
QL 10 WTL 6/4 FF		1897090000
QL 50 WTL 6/4 FF		1897100000
Q 2 WTL 6/4 FF		1897110000
Q 3 WTL 6/4 FF		1897120000
Q 4 WTL 6/4 FF		1897130000
Q 10 WTL 6/4 FF		1897190000
DS 13.5 WTL 6/4		1897000000
QS 2 (2-pole)		0270760000
LIR 1.5 M4 V		9200090000
LIR 2.5 M4 V		9200170000
LIR 6 M4 V		9200230000
SDI 0.8 x 4.0		9008400000
SD 0.8 x 4.0		9008340000
SDIZ 0.8 x 5.5		9008640000
CTI 6		9006120000
WS 10/5 / DEK 5		
For additional test-disconnect terminal accessories, refer to the Accessories Chapter.		

WTL 35

35 mm²



width x length x height with TS 35 x 15 mm
 max. current / max. cond. cross-section A/mm²
 max. clamping range mm²

16 / 100 / 68

125 / 35

35

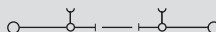

Technical data

Rated data

Rated voltage	V	500
Rated current	A	125
Rated cross-section	mm ²	35
Rated impulse withstand voltage / Pollution severity	kV/-	6 / 3
Gauge to IEC 60947-1 / UL94 Flammability class		B9 / V-0

Clamped conductors

„e“ solid H07V-U	mm ²	4 ... 16
„m“ stranded H07V-R	mm ²	10 ... 35
„f“ flexible H07V-K	mm ²	4 ... 35
„f“ flexible H07V-K mit AEH	mm ²	4 ... 35
Tightening torque range clamping screw	Nm	4
Tightening torque slider screw	Nm	1,2
Stripping length/Clamping screw/Blade size	mm/-	18 / M6 / 6.5 x 1.2

Note

IEC 60 947-7-1

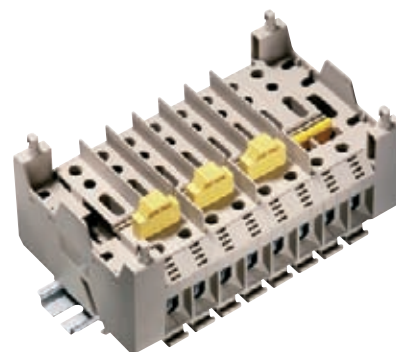

Ordering data

Ausführung

dark beige Wemid	with 2x test socket	
	with 1x test socket	
	with Cross-connection channel Type WQV 35	

Note

Type	Current [A]	Qty.	Order No.
WTL 35/2/STB	125	10	1925030000
WTL 35/1/STB	125	10	1925060000
WTL 35/1/STB/WQV	125	10	1925050000

Accessories

End bracket

width x length x height with TS 35 x 15	18 / 100 / 79.4 mm
End bracket	dark beige Wemid

Cross-connection

Short-circuit plugs	yellow Wemid
Cross-connection (screwed) / permanent	2-pole

Cover

width x length x height with TS 35 x 15	155/219/62 mm
Cover	
Fixing element for cover profile	dark beige Wemid

Screwdriver

slot-head screwdriver

Type	Qty.	Order No.
WEW WTL 35	10	1925040000
WQS 2/16 / 5	5	1925070000
WQV 35/2	50	1053060000
ADHB / 8 WTL 35	1	2334730000
BFEL + BEMU WEW WTL 35	20	1964820000
SD 1.2 x 6.5 x 150	1	9009010000



Marking systems

Marking tags

WS 12/6

Test-disconnect terminals

Accessories for test-disconnect terminals

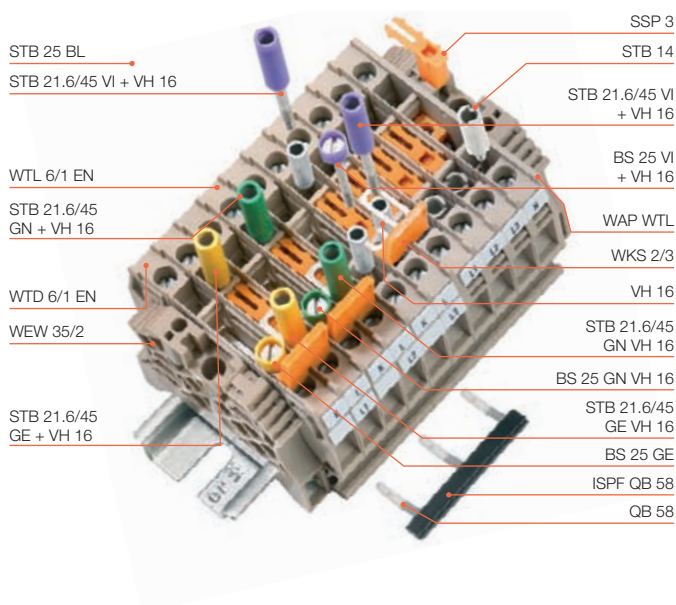

Cross-connection slider QVS ...

Connection sleeves VH 19 and fixing screws BS 25 (or sockets StB 35) are required for fastening the QVS in the individual terminals. The fixing screws have an insulating sleeve as colour marking and a screwdriver guide. Cross-connection sliders are designed so that the sockets inserted in the terminals remain available for test plugs at every position. The 2-pole version type QVS 2S is designed to slide with test plugs plugged in. If the option of testing is required when the QVS is plugged in, socket StB 35 can be used for fastening. The clearance and creepage sections required for the rated voltage of the terminal are changed when accessories are fitted.

Sockets **type StB** are screwed into the busbar of the terminal. They take test plugs type PS4 or cross-connectors type QS2.

QVSK 2 (167036)

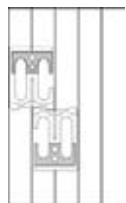

WTL6/1, WTD6/1

QVS 2 (030730)

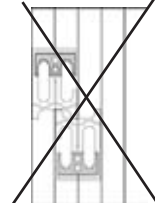

WTL6/1, WTD6/1

Note:

QVS 2 cannot be switched offset to each other.

Technical data

Rated voltage		for neighbouring	
for neighbouring	rated voltage	for neighbouring	rated voltage
QVS	63 V	STB 25	63 V
WQV	up to 400 V	STB 30.5	63 V
QL	250 V	STB 35	63 V

SSP WTL, SSP 3 and SSP 4 prevent unwanted opening or closing of current circuits. They block the disconnecting slider in its particular position. The lockout device is easily pressed into the terminal, but can only be removed again with a tool.

To retain the rated voltage, partition plates TW or partition discs TSch have to be used, except with WQV.



Type	Qty.	Order No.
SSP 3	100	0531760000
SSP 4	20	1319360000
SSP WTL	100	1604200000

QVS 1

Cross-connection slider



QVS QVS QVSK 2 QVS 2S

Type	No. of poles	Qty.	Order No.
QVS 2	2	20	0307300000
QVSK 2	2	20	1670360000
QVS 3	3	20	0329300000
QVS 4	4	20	0307400000
QVS 2S	2	20	0358460000

STB

Cross-connection slider



Type	Colour	Qty.	Order No.
STB 14			
STB 14		50	0169900000
STB 25			
STB 21.6/45 BL	blue	50	1936290000
STB 21.6/45 DB d.	blue	50	1938790000
STB 21.6/45 GE	yellow	50	1936240000
STB 21.6/45 GN	green	50	1936250000
STB 21.6/45 GR	grey	50	1936280000
STB 21.6/45 RT	red	50	1936300000
STB 21.6/45 SW	black	50	1936270000
STB 21.6/45 VI	violet	50	1936260000
STB 30.5			
STB 30.5	black	50	0341000000
STB 30.5	grey	50	0341100000
STB 30.5	blue	50	0341200000
STB 30.5	red	50	0341300000
STB 30.5	green	50	0341400000
STB 30.5	yellow	50	0341500000
STB 30.5	violet	50	0341600000
STB 35			
STB 35	yellow	50	0389000000
STB 35	green	50	0388900000
STB 35	violet	50	0389100000
STB 35	black	50	0388500000
STB 35	grey	50	0388600000
STB 35	blue	50	0388700000
STB 35	red	50	0388800000

Accessories for test-disconnect terminals

BS fixing screws

VH connecting sleeves

WQV cross-connections

WQV cross-connections allow for finger and hand-safe connection between neighbouring terminals in accordance with VBG 4.

QL cross-connection lug

Model QL cross-connection links serve as fixed (i.e. non-switchable) cross-connections when used with WLT 6.1 test-disconnect terminals. They are fastened with connecting sleeves VH 12 and fixing screws BS M 3 x 20 (or sockets StB 30.5). The clearance and creepage distances required for the rated voltage of the terminal can be changed when accessories are installed. This applies in particular to the cross-connection of neighbouring terminals of differing potential.

WKB / WKS cross-connection bridge

WKB can be inserted from above in the case of cross-disconnect terminal type WTQ 6/1. The integrated disconnect slider is then responsible for connection or disconnection.

QS2 cross-connection plug

For sockets diameter 4 mm, for loads up to 44 A..

BS / VH



Type	Colour	Qty.	Order No.
Fixing screws			
BS 25	yellow	50	0335700000
BS 25	green	50	0335600000
BS 25	violet	50	0335800000
BS 25	grey	50	0335300000
BS 25	black	50	0335200000
BS 25	blue	50	0335400000
BS 25	red	50	0335500000
BS 25	blank	50	0334700000
KISC M3X20		100	0377100000
SAK10 CU5			
Connecting sleeves			
VH 19		50	0318000000
CuZn 39 (brass alloy)			
VH 12		100	0249000000
E-Cu 57 (copper alloy)			

WQV / QL



WQV (only for WTL 6/2, WTL 6/3)

Type	No. of poles	Qty.	Order No.
WQV			
WQV 6/2	2	50	1052360000
WQV 6/3	3	50	1054760000
WQV 6/4	4	50	1054860000
WQV 6/5	5	50	1062660000
WQV 6/7	7	50	1062680000
WQV 6/10	10	20	1052260000
WKS 2/2	2	50	1936150000
WKS 2/3	3	50	1936140000
QL			
QL 2	2	50	0194300000
QL 3	3	50	0194400000
QL 4	4	50	0194500000
QL 5	5	50	0220500000
QL 6	6	50	0220600000
QL 10	10	20	0338300000
QL 15	15	10	0221200000

WKS / WKB



WKS

WKB

Type	No. of poles	Qty.	Order No.
WQV			
WKB 1/2	2	50	1604280000
WKB 1/3	3	50	1604300000
WKB 1/4	4	50	1604320000
WKB 1/10	10	20	1604330000
WKS			
WKS 1/2	2	50	1604270000
WKS 1/3	3	50	1604290000
WKS 1/4	4	50	1604310000
WKS 2/2	2	50	1936150000
WKS 2/3	3	50	1936140000

QS 2



Type	No. of poles	Qty.	Order No.
WQV			
QS 2	2	20	0270960000
x = 8 mm, y = 16 mm			
QS 2	2	20	0270860000
x = 10 mm, y = 20 mm			
QS 2	2	20	0270760000
x = 12 mm, y = 20 mm			

Terminals with spring-loaded cable clamps

Spring below clamping yoke ensures additional contact stability.

In hazardous area applications, the installation instructions and the rated data specifications for accessories given in the technical appendix must be followed.

Width/Length/height with TS35x7.5	mm
max. current / max. cond. cross-section	A/mm ²
Max. clamping range	mm ²

Technical data

Rated data	
Rated voltage	V
Rated current	A
Rated cross-section	mm ²
Rated impulse voltage / Pollution severity	kV/-
Gauge to IEC 60947-1 / UL94 Flammability class	
Approvals	
Clamped conductors (H05V/H07V)	
solid / stranded	mm ²
flexible / Stranded wire with end ferrules	mm ²
Tightening torque range (clamping screw)	
Stripping length / Blade size	mm/-
2 conductors with same cross-section (H05V/H07V)	
solid / stranded	mm ²
flexible / Stranded wire with end ferrules	mm ²
Note	

Ordering data

Version	
	Dark beige Wemid
	Dark beige Wemid (combi clip-on feet TS32/25)
	Black Wemid (combi clip-on feet TS32/25)
Note	

Accessories

Pluggable cross-connection	
	2-pole
	3-pole
	4-pole
	10-pole
	20-/24-pole
Screwable cross-connection	
	2-pole
	3-pole
	4-pole
	10-pole
End plate / partition	
	Dark beige Wemid
	Black Wemid
	Dark beige Wemid
End bracket	
	Dark beige Wemid
Testing / Checking	
	Standard

Marking systems	
	(see assortment in catalogue 7)
	Marking tags
For detailed information on other accessories and applications, refer to the „Accessories“ section	

WDU 4 SL

4 mm²



6.1 x 60 x 47	
41 / 6	
0.22...6	

IEC 60947-7-1				Ex e ll Ex II 2 G D			
IEC	UL	CSA	EN 60079-7	IEC	UL	CSA	EN 60079-7
500	600	300	275	500	150	300	275
32	30	25	28	41	45	45	36
4	AWG 22...10	AWG 22...10	4	6	AWG 20...8	AWG 20...8	6
				6 / 3			
				A4 / V-0			
SIRA 02ATEX3242 U				SIRA 02ATEX3242 U			
Rated connection							
0.5...6 / 1.5...6		0.5...4 / 0.5...4		0.5...1.0 Nm (M 3)		15 / 0.6 x 3.5 mm	
0.5...1.5		0.5...1.5 / 0.5...1.5		Note the max. current of the terminal (41 A) when using the cross-connector!			

Type	Qty	Order No.
WDU 4 SL	50	9537440000

Type	current	Qty	Order No.
ZQV 4N/2 GE	32 A	60	1758250000
ZQV 4N/3 GE	32 A	60	1762630000
ZQV 4N/4 GE	32 A	60	1762620000
ZQV 4N/10 GE	32 A	20	1758260000
ZQV 4N/20 GE	32 A	20	1909020000
Width			
WAP 2.5-10	1.5 mm	50	1050000000
WAP 2.5-10 SW	1.5 mm	50	1050010000
WAP 16+35 WTW 2.5-10	1.5 mm	20	1050100000
Testing / Checking			
WEW 35/2	8 mm	100	1061200000
WTA 3 WDU4	6 mm	25	1632350000

Marking systems	
	WS 12/6
Hook-shaped cable lugs 1-2.5mm ² thin version order no. 9036300000 (100 pcs.)	

WDU 6 SL

6 mm²



7.9 x 60 x 47	
57 / 10	
0.5...10	

IEC 60947-7-1				Ex e ll Ex II 2 G D			
IEC	UL	CSA	EN 60079-7	IEC	UL	CSA	EN 60079-7
500	150	300	275	500	150	300	275
41	45	45	36	41	45	45	36
6	AWG 20...8	AWG 20...8	6	6	AWG 20...8	AWG 20...8	6
				6 / 3			
				A5 / V-0			
SIRA 02ATEX3242 U				SIRA 02ATEX3242 U			
Rated connection							
0.5...10 / 1.5...10		0.5...6 / 0.5...6		0.8...1.4 Nm (M 3.5)		16 / 4.0 x 0.8 mm	
1.5...2.5		1.5...2.5 / 0.5...2.5		ESI rated data: 500 V/24 A / Note the max. current of the terminal (57 A) when using the cross-connector!			

Type	Qty	Order No.
WDU 6 SL	50	9537460000

Type	current	Qty	Order No.
WQV 6/2	57 A	50	1052360000
WQV 6/3	57 A	50	1054760000
WQV 6/4	57 A	50	1054860000
WQV 6/10	57 A	20	1052260000
Width			
WAP 2.5-10	1.5 mm	50	1050000000
WAP 2.5-10 SW	1.5 mm	50	1050010000
WAP 16+35 WTW 2.5-10	1.5 mm	20	1050100000
Testing / Checking			
WEW 35/2	8 mm	100	1061200000
WTA 5/1	5 mm	25	1051260000

Marking systems	
	DEK 5/8 / WS 12/6.5
Hook-shaped cable lugs, wide design 0.25-1.5mm ² , order no. 9036290000 (100 pcs.); and 1-2.5mm ² thin version, order no.	

WDU 10 SL

10 mm²



9.9 x 60 x 47
76 / 16
1.31...16

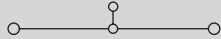

IEC 60947-7-1 Ex e II **Ex** II 2 G D

IEC	UL	CSA	EN 60079-7
500	150	300	275
57	50	65	50
10	AWG 16...8	AWG 16...8	10
6 / 3			
A6 / V-0			

UL SIRA 02ATEX3242 U

Rated connection	
1.5...16 / 1.5...16	
1...6 / 1.5...10	
1.2...2.4 Nm (M 4)	
17 / 1.0 x 5.5 mm	
2.5...4	
2.5...4 / 1...4	
ESI rated data: 500 V/36 A / 16 mm ² stranded connection must be tightened with 2 Nm.	

Type	Qty	Order No.
WDU 10 SL	50	9537480000

Type	Qty	Order No.
current		
WQV 10/2	57 A 50	1052560000
WQV 10/3	57 A 50	1054960000
WQV 10/4	57 A 50	1055060000
WQV 10/10	57 A 20	1052460000
Width		
WAP 2.5-10	1.5 mm 50	1050000000
WAP 2.5-10 SW	1.5 mm 50	1050010000
WAP 16+35 WTW 2.5-10	1.5 mm 20	1050100000
WEW 35/2	8 mm 100	1061200000
WTA 5/1	5 mm 25	1051260000

DEK 5/5 / WS 12/6,5
 Hook-shaped cable lugs, wide design 0.25-1.5mm², order no. 9036290000 (100 pcs.); and 1-2.5mm² thin version, order no.

WTR 4 SL

4 mm²

with clamping screw



6.1 x 61.5 x 48.6
32 / 6
0.22...6

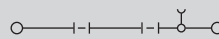

IEC 60947-7-1

IEC	UL	CSA
500	300	300
32	22	24
4	AWG 22...10	AWG 22...10
6 / 3		
A4 / V-0		

UL

Rated connection	
0.5...6 / 1.5...6	
0.5...4 / 0.5...4	
0.5...0.6 Nm (M 3)	
13 / 0.6 x 3.5 mm	
0.5...1.5	
0.5...1.5 / 0.5...1.5	
UL/CSA 600 V possible with end plate WAP or W partition plate.	

Type	Qty	Order No.
WTR 4 SL	50	7910270000

Type	current	Qty	Order No.
ZQV 4N/2 GE	32 A 60	1758250000	
ZQV 4N/3 GE	32 A 60	1762630000	
ZQV 4N/4 GE	32 A 60	1762620000	
ZQV 4N/10 GE	32 A 20	1758260000	
ZQV 4N/20 GE	32 A 20	1909020000	
Width			
WAP 2.5-10	1.5 mm 50	1050000000	
WAP 2.5-10 SW	1.5 mm 50	1050010000	
WAP 16+35 WTW 2.5-10	1.5 mm 20	1050100000	
WEW 35/2	8 mm 100	1061200000	

DEK 5/6 / WS 12/6
 Hook-shaped cable lugs 1 - 2.5 mm² (black) order no. 9036290000 (100 pcs)

WTR 4 SL STB

4 mm²

With socket

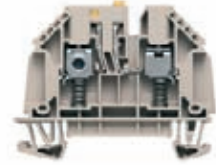

6.1 x 61.5 x 48.6
32 / 6
0.22...6

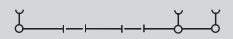

IEC 60947-7-1

IEC	UL	CSA
500	300	300
32	22	24
4	AWG 22...10	AWG 22...10
6 / 3		
A4 / V-0		

UL

Rated connection	
0.5...6 / 1.5...6	
0.5...4 / 0.5...4	
0.5...0.6 Nm (M 3)	
13 / 0.6 x 3.5 mm	
0.5...1.5	
0.5...1.5 / 0.5...1.5	
UL/CSA 600 V possible with end plate WAP or WTW partition plate.	

Type	Qty	Order No.
WTR 4 STB SL	50	7910300000

Type	current	Qty	Order No.
ZQV 4N/2 GE	32 A 60	1758250000	
ZQV 4N/3 GE	32 A 60	1762630000	
ZQV 4N/4 GE	32 A 60	1762620000	
ZQV 4N/10 GE	32 A 20	1758260000	
ZQV 4N/20 GE	32 A 20	1909020000	
Width			
WAP 2.5-10	1.5 mm 50	1050000000	
WAP 2.5-10 SW	1.5 mm 50	1050010000	
WAP 16+35 WTW 2.5-10	1.5 mm 20	1050100000	
WEW 35/2	8 mm 100	1061200000	

DEK 5/6 / WS 12/6
 Hook-shaped cable lugs 1 - 2.5 mm² (black) order no. 9036290000 (100 pcs)

Terminals with spring-loaded cable clamps

Spring below clamping yoke ensures additional contact stability.

In hazardous area applications, the installation instructions and the rated data specifications for accessories given in the technical appendix must be followed.

Width/Length/height with TS35x7.5	mm
max. current / max. cond. cross-section	A/mm ²
Max. clamping range	mm ²

Technical data

Rated data	
Rated voltage	V
Rated current	A
Rated cross-section	mm ²
Rated impulse voltage / Pollution severity	kV/-
Gauge to IEC 60947-1 / UL94 Flammability class	
Approvals	
Clamped conductors (H05V/H07V)	
solid / stranded	mm ²
flexible / Stranded wire with end ferrules	mm ²
Tightening torque range (clamping screw)	
Stripping length / Blade size	mm/-
2 conductors with same cross-section (H05V/H07V)	
solid / stranded	mm ²
flexible / Stranded wire with end ferrules	mm ²
Note	

Ordering data

Version	Type	Qty	Order No.
Dark beige Wemid	WDU 4 SL/EN	50	9537450000
Dark beige Wemid (combi clip-on feet TS32/25)	WDU 4 SL/EN SW	50	9537510000
Black Wemid (combi clip-on feet TS32/25)			
Note			

Accessories

Pluggable cross-connection	
2-pole	ZQV 4N/2 GE
3-pole	ZQV 4N/3 GE
4-pole	ZQV 4N/4 GE
10-pole	ZQV 4N/10 GE
20-/24-pole	ZQV 4N/20 GE
Screwable cross-connection	
2-pole	WQV 4/2
3-pole	WQV 4/3
4-pole	WQV 4/4
10-pole	WQV 4/10
End plate / partition	
Dark beige Wemid	WAP 2.5-10
Black Wemid	WAP 2.5-10 SW
Dark beige Wemid	WAP 16+35 WTW 2.5-10
End bracket	
Dark beige Wemid	WEW 35/2
Testing / Checking	
Standard	WTA 3 WDU4

Marking systems	
(see assortment in catalogue 7)	WS 12/6
Marking tags	Hook-shaped cable lugs 1-2.5mm ² thin version (order no. 9036300000 (100 pcs.))
For detailed information on other accessories and applications, refer to the „Accessories“ section	

WDU 4 SL/EN

4 mm²

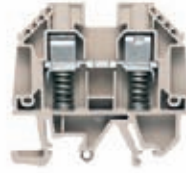

6.1 x 60 x 47	
41 / 6	
0.22...6	

IEC 60947-7-1				Ex e ll Ex II 2 G D			
IEC	UL	CSA	EN 60079-7	IEC	UL	CSA	EN 60079-7
500	600	300	275	500	150	300	275
32	30	25	28	41	45	45	36
4	AWG 22...10	AWG 22...10	4	6	AWG 20...8	AWG 20...8	6
				6 / 3			
				A4 / V-0			
				SIRA 02ATEX3242 U			
Rated connection							
0.5...6 / 1.5...6							
0.5...4 / 0.5...4							
0.5...1.0 Nm (M 3)							
15 / 0.6 x 3.5 mm							
0.5...1.5							
0.5...1.5 / 0.5...1.5							
Note							
Note the max. current of the terminal (41 A) when using the cross-connector!							

Type	Qty	Order No.
WDU 4 SL/EN	50	9537450000
WDU 4 SL/EN SW	50	9537510000

Type	current	Qty	Order No.
ZQV 4N/2 GE	32 A	60	1758250000
ZQV 4N/3 GE	32 A	60	1762630000
ZQV 4N/4 GE	32 A	60	1762620000
ZQV 4N/10 GE	32 A	20	1758260000
ZQV 4N/20 GE	32 A	20	1909020000
Width			
WAP 2.5-10	1.5 mm	50	1050000000
WAP 2.5-10 SW	1.5 mm	50	1050010000
WAP 16+35 WTW 2.5-10	1.5 mm	20	1050100000
Width			
WEW 35/2	8 mm	100	1061200000
WTA 3 WDU4	6 mm	25	1632350000

Marking systems	
(see assortment in catalogue 7)	WS 12/6
Marking tags	Hook-shaped cable lugs, wide design 0.25-1.5mm ² , order no. 9036300000 (100 pcs.); and 1-2.5mm ² thin version, order no. 9036300000 (100 pcs.)
For detailed information on other accessories and applications, refer to the „Accessories“ section	

WDU 6 SL/EN

6 mm²

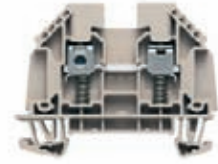

7.9 x 60 x 47	
57 / 10	
0.5...10	

IEC 60947-7-1				Ex e ll Ex II 2 G D			
IEC	UL	CSA	EN 60079-7	IEC	UL	CSA	EN 60079-7
500	150	300	275	500	150	300	275
41	45	45	36	41	45	45	36
6	AWG 20...8	AWG 20...8	6	6	AWG 20...8	AWG 20...8	6
				6 / 3			
				A5 / V-0			
				SIRA 02ATEX3242 U			
Rated connection							
0.5...10 / 1.5...10							
0.5...6 / 0.5...6							
0.8...1.4 Nm (M 3.5)							
16 / 4.0 x 0.8 mm							
1.5...2.5							
1.5...2.5 / 0.5...2.5							
Note							
ESI rated data: 500 V/24 A / Note the max. current of the terminal (57 A) when using the cross-connector!							

Type	Qty	Order No.
WDU 6 SL/EN	50	9537470000
WDU 6 SL/EN SW	50	9537430000

Type	current	Qty	Order No.
WQV 6/2	57 A	50	1052360000
WQV 6/3	57 A	50	1054760000
WQV 6/4	57 A	50	1054860000
WQV 6/10	57 A	20	1052260000
Width			
WAP 2.5-10	1.5 mm	50	1050000000
WAP 2.5-10 SW	1.5 mm	50	1050010000
WAP 16+35 WTW 2.5-10	1.5 mm	20	1050100000
Width			
WEW 35/2	8 mm	100	1061200000
WTA 5/1	5 mm	25	1051260000

Marking systems	
(see assortment in catalogue 7)	DEK 5/8 / WS 12/6.5
Marking tags	Hook-shaped cable lugs, wide design 0.25-1.5mm ² , order no. 9036300000 (100 pcs.); and 1-2.5mm ² thin version, order no. 9036300000 (100 pcs.)
For detailed information on other accessories and applications, refer to the „Accessories“ section	

WDU 10 SL/EN

10 mm²



9.9 x 56.6 x 47
76 / 16
1.31...16

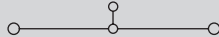

IEC 60947-7-1 Ex e II **Ex** II 2 G D

IEC	UL	CSA	EN 60079-7
500	150	300	275
57	50	65	50
10	AWG 16...8	AWG 16...8	10
6 / 3			
A6 / V-0			

UL SIRA 02ATEX3242 U

Rated connection	
1.5...16 / 1.5...16	
1...6 / 1.5...10	
1.2...2.4 Nm (M 4)	
17 / 1.0 x 5.5 mm	
2.5...4	
2.5...4 / 1...4	
ESI rated data: 500 V/36 A / 16 mm ² stranded connection must be tightened with 2 Nm.	

Type	Qty	Order No.
WDU 10 SL/EN	50	9537490000
WDU 10 SL/EN SW	50	9537410000

Type	Qty	Order No.
current		
WQV 10/2	57 A 50	1052560000
WQV 10/3	57 A 50	1054960000
WQV 10/4	57 A 50	1055060000
WQV 10/10	57 A 20	1052460000
Width		
WAP 2.5-10	1.5 mm 50	1050000000
WAP 2.5-10 SW	1.5 mm 50	1050010000
WAP 16+35 WTW 2.5-10	1.5 mm 20	1050100000
WEW 35/2	8 mm 100	1061200000
WTA 5/1	5 mm 25	1051260000

DEK 5/5 / WS 12/6,5
 Hook-shaped cable lugs, wide design 0.25-1.5mm², order no. 9036290000 (100 pcs.); and 1-2.5mm² thin version, order no. 9036300000 (100 pcs.)

WTR 4 SL/EN

4 mm²

with clamping screw

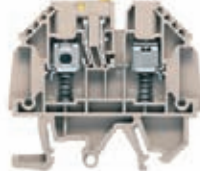

6.1 x 61.5 x 48.6
32 / 6
0.22...6

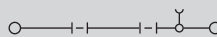

IEC 60947-7-1

IEC	UL	CSA
500	300	300
32	22	24
4	AWG 22...10	AWG 22...10
6 / 3		
A4 / V-0		

UL

Rated connection	
0.5...6 / 1.5...6	
0.5...4 / 0.5...4	
0.5...0.6 Nm (M 3)	
13 / 0.6 x 3.5 mm	
0.5...1.5	
0.5...1.5 / 0.5...1.5	
UL/CSA 600 V possible with end plate WAP or W partition plate.	

Type	Qty	Order No.
WTR4 SL/EN	50	7910360000
WTR4 SL/EN SW	50	7910380000

Type	current	Qty	Order No.
ZQV 4N/2 GE	32 A 60	1758250000	
ZQV 4N/3 GE	32 A 60	1762630000	
ZQV 4N/4 GE	32 A 60	1762620000	
ZQV 4N/10 GE	32 A 20	1758260000	
ZQV 4N/20 GE	32 A 20	1909020000	
Width			
WAP 2.5-10	1.5 mm 50	1050000000	
WAP 2.5-10 SW	1.5 mm 50	1050010000	
WAP 16+35 WTW 2.5-10	1.5 mm 20	1050100000	
WEW 35/2	8 mm 100	1061200000	

DEK 5/6 / WS 12/6
 Hook-shaped cable lugs 1 - 2.5 mm² (black) order no. 9036290000 (100 pcs)

WTR 4 StB SL/EN

4 mm²

With socket

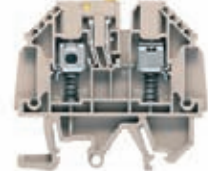

6.1 x 61.5 x 48.6
32 / 6
0.22...6

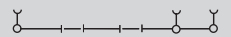

IEC 60947-7-1

IEC	UL	CSA
500	300	300
32	22	24
4	AWG 22...10	AWG 22...10
6 / 3		
A4 / V-0		

UL

Rated connection	
0.5...6 / 1.5...6	
0.5...4 / 0.5...4	
0.5...0.6 Nm (M 3)	
13 / 0.6 x 3.5 mm	
0.5...1.5	
0.5...1.5 / 0.5...1.5	
UL/CSA 600 V possible with end plate WAP or WTW partition plate.	

Type	Qty	Order No.
WTR4 SL/EN STB	50	7910390000
WTR4 SL/EN STB SW	50	7910410000

Type	current	Qty	Order No.
ZQV 4N/2 GE	32 A 60	1758250000	
ZQV 4N/3 GE	32 A 60	1762630000	
ZQV 4N/4 GE	32 A 60	1762620000	
ZQV 4N/10 GE	32 A 20	1758260000	
ZQV 4N/20 GE	32 A 20	1909020000	
Width			
WAP 2.5-10	1.5 mm 50	1050000000	
WAP 2.5-10 SW	1.5 mm 50	1050010000	
WAP 16+35 WTW 2.5-10	1.5 mm 20	1050100000	
WEW 35/2	8 mm 100	1061200000	

DEK 5/6 / WS 12/6
 Hook-shaped cable lugs 1 - 2.5 mm² (black) order no. 9036290000 (100 pcs)

Terminals with spring-loaded cable clamps

Spring below clamping yoke ensures additional contact stability.

In hazardous area applications, the installation instructions and the rated data specifications for accessories given in the technical appendix must be followed.

Width/Length/height with TS35x7.5	mm
max. current / max. cond. cross-section	A/mm ²
Max. clamping range	mm ²

Technical data

Rated data	
Rated voltage	V
Rated current	A
Rated cross-section	mm ²
Rated impulse voltage / Pollution severity	kV/-
Gauge to IEC 60947-1 / UL94 Flammability class	
Approvals	

Clamped conductors (H05V/H07V)

solid / stranded	mm ²
flexible / Stranded wire with end ferrules	mm ²
Tightening torque range (clamping screw)	
Stripping length / Blade size	mm/-
2 conductors with same cross-section (H05V/H07V)	
solid / stranded	mm ²
flexible / Stranded wire with end ferrules	mm ²

Note

Ordering data

Version	
	Dark beige Wemid
	Dark beige Wemid (combi clip-on feet TS32/25)
	Black Wemid (combi clip-on feet TS32/25)

Note

Accessories

Pluggable cross-connection	
	2-pole
	3-pole
	4-pole
	10-pole
	20-/24-pole
Screwable cross-connection	
	2-pole
	3-pole
	4-pole
	10-pole
End plate / partition	
	Dark beige Wemid
	Black Wemid
	Dark beige Wemid
End bracket	
	Dark beige Wemid
Testing / Checking	
	Standard

Marking systems	(see assortment in catalogue 7)
	Marking tags

For detailed information on other accessories and applications, refer to the „Accessories“ section

WTR 4 SI SL

4 mm²

With fuse holder



6.1 x 61.5 x 80.5
6.3 / 6
0.22...6

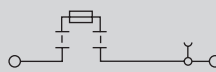

IEC 60947-7-1

IEC	UL	CSA
400	300	300
6.3	6.3	6.3
4	AWG 22...10	AWG 22...10
6 / 3		
A4 / V-0		

Rated connection

0.5...6 / 1.5...6
0.5...4 / 0.5...4
0.5...0.6 Nm (M 3)
13 / 0.6 x 3.5 mm
0.5...1.5
0.5...1.5 / 0.5...1.5

Type	Qty	Order No.
WTR 4 SI SL	25	7910330000

Type	current	Qty	Order No.
ZQV 4N/2 GE	32 A	60	1758250000
ZQV 4N/3 GE	32 A	60	1762630000
ZQV 4N/4 GE	32 A	60	1762620000
ZQV 4N/10 GE	32 A	20	1758260000
ZQV 4N/20 GE	32 A	20	1909020000

Width			
WAP 2.5-10	1.5 mm	50	1050000000
WAP 2.5-10 SW	1.5 mm	50	1050010000
WAP 16+35 WTW 2.5-10	1.5 mm	20	1050100000
WEW 35/2	8 mm	100	1061200000

DEK 5/6 / WS 12/6

Hook-shaped cable lugs 1 - 2.5 mm² (black) order no. 9036290000 (100 pcs)

WTL 6 SL

6 mm²

Longitudinal - disconnecter



7.9 x 82.7 x 50.4
57 / 10
0.5...10

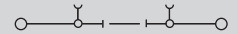

IEC 60947-7-1

IEC	UL	CSA
500	300	300
41	45	45
6	AWG 20...8	AWG 20...8
6 / 3		
A5 / V-0		

Rated connection

0.5...10 / 1.5...10
0.5...6 / 0.5...6
0.8...1.6 Nm (M 3.5)
16 / 4.0 x 0.8 mm
1.5...2.5
1.5...2.5 / 1.5...2.5

ESI rated data: 500 V/24 A.

Type	Qty	Order No.
WTL 6 SL	50	9538070000

Type	current	Qty	Order No.
QL 2 SAK6N	32 A	50	0194300000
QL 3 SAK6N	57 A	50	0194400000
QL 4 SAK6N	57 A	50	0194500000
QL 10 SAK6N	32 A	20	0338300000

Width			
WTW EN	3 mm	20	1058800000
WEW 35/2	8 mm	100	1061200000

WS 12/6,5

Hook-shaped cable lugs 0.25-1.5 mm² (black) order no. 9036290000 (100 pcs) / 1-2.5 mm² (black) order no. 9036300000 (100 pcs)

WTD 6 SL

6 mm²

Feed-through

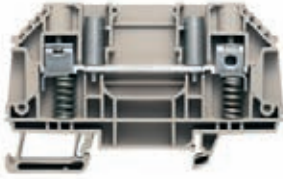

7.9 x 82.7 x 50.4

57 / 10

0.5...10



IEC 60947-7-1

IEC	UL	CSA
500	300	300
41	45	45
6	AWG 20...8	AWG 20...8
	6 / 3	
	A5 / V-0	



Rated connection

0.5...10 / 1.5...10

0.5...6 / 0.5...6

0.8...1.6 Nm (M 3.5)

16 / 4.0 x 0.8 mm

1.5...2.5

1.5...2.5 / 1.5...2.5

ESI rated data: 500 V/24 A.

Type	Qty	Order No.
WTD 6 SL	50	9538090000

Type	Qty	Order No.
current		
QL 2 SAK6N	32 A	50 0194300000
QL 3 SAK6N	57 A	50 0194400000
QL 4 SAK6N	57 A	50 0194500000
QL 10 SAK6N	32 A	20 0338300000
Width		
WTW EN	3 mm	20 1058800000
WEW 35/2	8 mm	100 1061200000

WS 12/6,5

Hook-shaped cable lugs 0.25-1.5 mm² (black) order no. 9036290000 (100 pcs) / 1-2.5 mm² (black) order no. 9036300000 (100 pcs)

WTL 6 SL/EN

6 mm²

Longitudinal - disconnecter



7.9 x 82.7 x 50.4

57 / 10

0.5...10

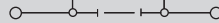

IEC 60947-7-1

IEC	UL	CSA
500	300	300
41	45	45
6	AWG 20...8	AWG 20...8
	6 / 3	
	A5 / V-0	



Rated connection

0.5...10 / 1.5...10

0.5...6 / 0.5...6

0.8...1.6 Nm (M 3.5)

16 / 4.0 x 0.8 mm

1.5...2.5

1.5...2.5 / 1.5...2.5

ESI rated data: 500 V/24 A.

Type	Qty	Order No.
WTL 6 SL/EN	50	9538080000
WTL 6 SL/EN SW	50	9538030000

Type	Qty	Order No.
current		
QL 2 SAK6N	32 A	50 0194300000
QL 3 SAK6N	57 A	50 0194400000
QL 4 SAK6N	57 A	50 0194500000
QL 10 SAK6N	32 A	20 0338300000
Width		
WTW EN	3 mm	20 1058800000
WEW 35/2	8 mm	100 1061200000

WS 12/6,5

Hook-shaped cable lugs 0.25-1.5 mm² (black) order no. 9036290000 (100 pcs) / 1-2.5 mm² (black) order no. 9036300000 (100 pcs)

WTD 6 SL/EN

6 mm²

Feed-through



7.9 x 82.7 x 50.4

57 / 10

0.5...10



IEC 60947-7-1

IEC	UL	CSA
500	300	300
41	45	45
6	AWG 20...8	AWG 20...8
	6 / 3	
	A5 / V-0	



Rated connection

0.5...10 / 1.5...10

0.5...6 / 0.5...6

0.8...1.6 Nm (M 3.5)

16 / 4.0 x 0.8 mm

1.5...2.5

1.5...2.5 / 1.5...2.5

ESI rated data: 500 V/24 A.

Type	Qty	Order No.
WTD 6 SL/EN	50	9538100000

Type	Qty	Order No.
current		
QL 2 SAK6N	32 A	50 0194300000
QL 3 SAK6N	57 A	50 0194400000
QL 4 SAK6N	57 A	50 0194500000
QL 10 SAK6N	32 A	20 0338300000
Width		
WTW EN	3 mm	20 1058800000
WEW 35/2	8 mm	100 1061200000

WS 12/6,5

Hook-shaped cable lugs 0.25-1.5 mm² (black) order no. 9036290000 (100 pcs) / 1-2.5 mm² (black) order no. 9036300000 (100 pcs)

Initiator and actuator terminals

Time- and space-saving wiring for initiators and actuators. All the connections for initiator and actuator are in one terminal.

In hazardous area applications, the installation instructions and the rated data specifications for accessories given in the technical appendix must be followed.

Width/Length/height with TS35x7.5	mm
max. current / max. cond. cross-section	A/mm ²
Max. clamping range	mm ²

Technical data

Rated data	
Rated voltage	V
Rated current	A
Rated cross-section	mm ²
Rated impulse voltage / Pollution severity	kV/-
Gauge to IEC 60947-1 / UL94 Flammability class	
Approvals	
Electronic fixtures	
Component voltage / Component current	V/A
Operating voltage for display, max. / Current	V/A
Clamped conductors (H05V/H07V)	
solid / stranded	mm ²
flexible / Stranded wire with end ferrules	mm ²
Tightening torque range (clamping screw)	
Stripping length / Blade size	mm/-
Note	

Ordering data

Version	
	Dark beige Wemid
	Dark beige Wemid (red LED)
	Dark beige Wemid (green LED)
Note	

Accessories

Screwable cross-connection	
	2-pole
	3-pole
	4-pole
	10-pole
End plate / partition	
	Dark beige Wemid
End bracket	
	Dark beige Wemid
Screwdriver	
	Standard

Marking systems (see assortment in catalogue 7)
Marking tags

For detailed information on other accessories and applications, refer to the „Accessories“ section

DLD 2.5

2.5 mm²

Voltage supply



6.1 x 82.5 x 49
24 / 4
0.13...4

IEC 60947-7-1

IEC	UL	CSA
250	300	300
24	10	10
2.5	AWG 22...12	AWG 26...12
4 / 3		
A3 / V-0		



Rated connection

0.5...4 / 1.5...4
0.5...4 / 0.5...2.5
0.4...0.6 Nm (M 2.5)
7 / 0.6 x 3.5 mm

Rated voltage is reduced to 30 V AC when one pole with a different potential is skipped with a cross-connector.

Type	Qty	Order No.
DLD 2.5 DB	50	1784180000
Blue version order No. 6269250000 (50 pcs)		

Type	current	Qty	Order No.
Q 2 DLI	20 A	50	1312500000
Q 3 DLI	20 A	50	1312600000
Q 4 DLI	20 A	50	1312700000
Q 10 DLI	20 A	20	1313100000
Width			
AP DLD2.5 DB	1.5 mm	20	1784210000
EW 35	8.5 mm	50	0383560000
SD 0.6x3.5x100		1	9008330000

DEK 5/6

Insulation plate TSCH 1 order No. 0319160000 (100 pcs)
Partial end plate TEAP DLD2.5/PE DB order No. 1783810000 (20 pcs)

DLD 2.5 PE

2.5 mm²

Lower level earthed

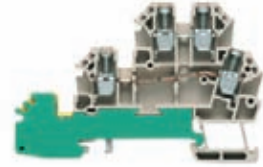

6.1 x 74.5 x 49
17.5 / 4
0.13...4

IEC 60947-7-1

IEC	UL	CSA
250	300	300
17.5	10	10
2.5	AWG 26...12	AWG 26...12
4 / 3		
A3 / V-0		



Rated connection

0.5...4 / 0.5...4
0.5...4 / 0.5...2.5
0.4...0.6 Nm (M 2.5)
7 / 0.6 x 3.5 mm

Rated voltage is reduced to 30 V AC when one pole with a different potential is skipped with a cross-connector.

Type	Qty	Order No.
DLD 2.5/PE DB	50	1783790000

Type	current	Qty	Order No.
Q 2 DLI	20 A	50	1312500000
Q 3 DLI	20 A	50	1312600000
Q 4 DLI	20 A	50	1312700000
Q 10 DLI	20 A	20	1313100000
Width			
AP DLD2.5/PE DB	1.5 mm	20	1783800000
EW 35	8.5 mm	50	0383560000
SD 0.6x3.5x100		1	9008330000

DEK 5/6

Insulation plate TSCH 1 order No. 0319160000 (100 pcs)
Partial end plate TEAP DLD2.5/PE DB order No. 1783810000 (20 pcs)

DLI 2.5

2.5 mm²

Initiator connection (signal,+,-)



6.1 x 66 x 49
26 / 4
0.13...4

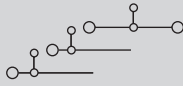

IEC 60947-7-1

IEC	UL	CSA
250	300	300
24	10	10
2.5	AWG 22...12	AWG 26...12
4 / 3		
A3 / V-0		



Rated connection

0.5...4 / 1.5...4
0.5...4 / 0.5...2.5
0.4...0.6 Nm (M 2.5)
7 / 0.6 x 3.5 mm

Rated voltage is reduced to 30 V AC when one pole with a different potential is skipped.

Type	Qty	Order No.
DLI 2.5 DB	100	1783820000

Type	current	Qty	Order No.
Q 2 DLI	20 A	50	1312500000
Q 3 DLI	20 A	50	1312600000
Q 4 DLI	20 A	50	1312700000
Q 10 DLI	20 A	20	1313100000
Width			
AP DLI2.5 DB	1.5 mm	20	1783550000
EW 35	8.5 mm	50	0383560000
SD 0.6x3.5x100		1	9008330000

DEK 5/6

Insulation plate TSCH 1 order No. 0319160000 (100 pcs), socket StB 8.5 in upper current bar (in conjunction with test plug PS 2.3).

DLI 2.5 LD PNP

2.5 mm²

Initiator connection with LED

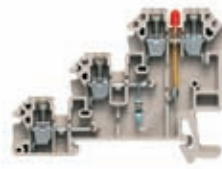

6.1 x 66 x 49
24 / 4
0.13...4

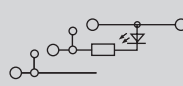

IEC 60947-7-1

IEC	UL	CSA
30	30	30
24	10	10
2.5	AWG 22...12	AWG 26...12
1 / 3		
A3 / V-0		



30 / 5

Rated connection

0.5...4 / 1.5...4
0.5...4 / 0.5...2.5
0.4...0.6 Nm (M 2.5)
7 / 0.6 x 3.5 mm

Type	Qty	Order No.
DLI 2.5/LD-RT/PNP +- DB	100	1783980000
DLI 2.5/LD-GN/PNP +- DB	100	1783970000

Type	current	Qty	Order No.
Q 2 DLI	20 A	50	1312500000
Q 3 DLI	20 A	50	1312600000
Q 4 DLI	20 A	50	1312700000
Q 10 DLI	20 A	20	1313100000
Width			
AP DLI2.5 DB	1.5 mm	20	1783550000
EW 35	8.5 mm	50	0383560000
SD 0.6x3.5x100		1	9008330000

DEK 5/6

Insulation plate TSCH 1 order No. 0319160000 (100 pcs)

DLI 2.5 LD NPN

2.5 mm²

Initiator connection with LED



6.1 x 66 x 49
24 / 4
0.13...4

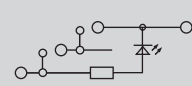

IEC 60947-7-1

IEC	UL	CSA
30	30	30
24	10	10
2.5	AWG 22...12	AWG 26...12
1 / 3		
A3 / V-0		



30 / 5

Rated connection

0.5...4 / 1.5...4
0.5...4 / 0.5...2.5
0.4...0.6 Nm (M 2.5)
7 / 0.6 x 3.5 mm

Type	Qty	Order No.
DLI 2.5/LD-RT/NPN +- DB	100	1783950000
DLI 2.5/LD-GN/NPN +- DB	100	1783940000

Type	current	Qty	Order No.
Q 2 DLI	20 A	50	1312500000
Q 3 DLI	20 A	50	1312600000
Q 4 DLI	20 A	50	1312700000
Q 10 DLI	20 A	20	1313100000
Width			
AP DLI2.5 DB	1.5 mm	20	1783550000
EW 35	8.5 mm	50	0383560000
SD 0.6x3.5x100		1	9008330000

DEK 5/6

Insulation plate TSCH 1 order No. 0319160000 (100 pcs)

Initiator and actuator terminals

Time- and space-saving wiring for initiators and actuators. All the connections for initiator and actuator are in one terminal.

In hazardous area applications, the installation instructions and the rated data specifications for accessories given in the technical appendix must be followed.

Width/Length/height with TS35x7.5	mm
max. current / max. cond. cross-section	A/mm ²
Max. clamping range	mm ²

Technical data

Rated data	
Rated voltage	V
Rated current	A
Rated cross-section	mm ²
Rated impulse voltage / Pollution severity	kV/-
Gauge to IEC 60947-1 / UL94 Flammability class	
Approvals	
Electronic fixtures	
Component voltage / Component current	V/A
Operating voltage for display, max. / Current	V/A
Clamped conductors (H05V/H07V)	
solid / stranded	mm ²
flexible / Stranded wire with end ferrules	mm ²
Tightening torque range (clamping screw)	
Stripping length / Blade size	mm/-
Note	

Ordering data

Version	
	Dark beige Wemid
	Dark beige Wemid (red LED)
	Dark beige Wemid (green LED)
Note	

Accessories

Screwable cross-connection	
	2-pole
	3-pole
	4-pole
	10-pole
End plate / partition	
	Dark beige Wemid
End bracket	
	Dark beige Wemid
Screwdriver	
	Standard

Marking systems	(see assortment in catalogue 7)
	Marking tags
For detailed information on other accessories and applications, refer to the „Accessories“ section	

DLA 2.5

2.5 mm²

Actuator connection (signal,-,PE)

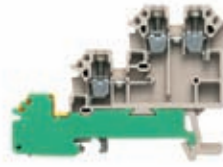

6.1 x 65 x 49	
26 / 4	
0.13...4	

IEC 60947-7-1 (-7-2)

IEC	UL	CSA
250	300	300
17.5	10	10
2.5	AWG 22...12	AWG 26...12
4 / 3		
A3 / V-0		
Rated connection		
0.5...4 / 1.5...4		
0.5...4 / 0.5...2.5		
0.4...0.6 Nm (M 2.5)		
7 / 0.6 x 3.5 mm		
Rated voltage is reduced to 30 V AC when one pole with a different potential is skipped with a cross-connector.		

DLA 2.5/D

2.5 mm²

Actuator connection (circuit with diode)

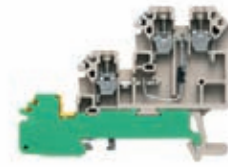

6.1 x 66 x 49	
17.5 / 4	
0.13...4	

IEC 60947-7-1 (-7-2)

IEC	UL	CSA
250	300	300
17.5	10	10
2.5	AWG 22...12	AWG 26...12
4 / 3		
A3 / V-0		
1000 / 1		
Rated connection		
0.5...4 / 1.5...4		
0.5...4 / 0.5...2.5		
0.4...0.6 Nm (M 2.5)		
7 / 0.6 x 3.5 mm		
Rated voltage is reduced to 30 V AC when one pole with a different potential is skipped with a cross-connector.		

Type	Qty	Order No.
DLA 2.5 DB	100	1783560000

Type	current	Qty	Order No.
Q 2 DLI	20 A	50	1312500000
Q 3 DLI	20 A	50	1312600000
Q 4 DLI	20 A	50	1312700000
Q 10 DLI	20 A	20	1313100000
Width			
AP DLI2.5 DB	1.5 mm	20	1783550000
EW 35	8.5 mm	50	0383560000
SD 0.6x3.5x100		1	9008330000

Type	Qty	Order No.
DLA 2.5/D DB	100	1783590000

Type	current	Qty	Order No.
Q 2 DLI	20 A	50	1312500000
Q 3 DLI	20 A	50	1312600000
Q 4 DLI	20 A	50	1312700000
Q 10 DLI	20 A	20	1313100000
Width			
AP DLI2.5 DB	1.5 mm	20	1783550000
EW 35	8.5 mm	50	0383560000
SD 0.6x3.5x100		1	9008330000

Marking systems	(see assortment in catalogue 7)
	Marking tags
For detailed information on other accessories and applications, refer to the „Accessories“ section	

DLA 2.5/LD

2.5 mm²

Actuator connection with LED

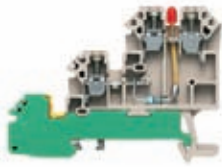

6.1 x 66 x 49
17.5 / 4
0.13...4

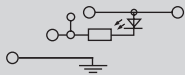

IEC 60947-7-1 (-7-2)

IEC	UL	CSA
30	30	30
17.5	10	10
2.5	AWG 22...12	AWG 26...12
	1 / 3	
	A3 / V-0	



30 / 5

Rated connection

0.5...4 / 1.5...4
 0.5...4 / 0.5...2.5
 0.4...0.6 Nm (M 2.5)
 7 / 0.6 x 3.5 mm

Type	Qty	Order No.
DLA 2.5/LD-RT DB	100	1783600000

Type	current	Qty	Order No.
Q 2 DLI	20 A	50	1312500000
Q 3 DLI	20 A	50	1312600000
Q 4 DLI	20 A	50	1312700000
Q 10 DLI	20 A	20	1313100000
	Width		
AP DLI2.5 DB	1.5 mm	20	1783550000
EW 35	8.5 mm	50	0383560000
SD 0.6x3.5x100		1	9008330000

DEK 5/6

Insulation plate TSCH 1 order No. 0319160000 (100 pcs)

DLA 2.5/LD/D

2.5 mm²

Actuator connection with LED

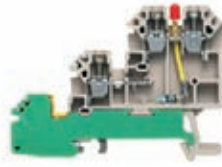

6.1 x 66 x 49
17.5 / 4
0.13...4

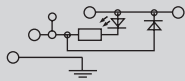

IEC 60947-7-1 (-7-2)

IEC	UL	CSA
30	30	30
17.5	10	10
2.5	AWG 22...12	AWG 26...12
	1 / 3	
	A3 / V-0	



1000 / 1

30 / 5

Rated connection

0.5...4 / 1.5...4
 0.5...4 / 0.5...2.5
 0.4...0.6 Nm (M 2.5)
 7 / 0.6 x 3.5 mm

Type	Qty	Order No.
DLA 2.5/LD-GN/D DB	100	1783630000

Type	current	Qty	Order No.
Q 2 DLI	20 A	50	1312500000
Q 3 DLI	20 A	50	1312600000
Q 4 DLI	20 A	50	1312700000
Q 10 DLI	20 A	20	1313100000
	Width		
AP DLI2.5 DB	1.5 mm	20	1783550000
EW 35	8.5 mm	50	0383560000
SD 0.6x3.5x100		1	9008330000

DEK 5/6

Insulation plate TSCH 1 order No. 0319160000 (100 pcs)

Motor-connection terminal

In hazardous area applications, the installation instructions and the rated data specifications for accessories given in the technical appendix must be followed.

Width/Length/height with TS35x7.5	mm
max. current / max. cond. cross-section	A/mm ²
Max. clamping range	mm ²

Technical data

Rated data	
Rated voltage	V
Rated current	A
Rated cross-section	mm ²
Rated impulse voltage / Pollution severity	kV/-
Gauge to IEC 60947-1 / UL94 Flammability class	
Approvals	
Clamped conductors (H05V/H07V)	
solid / stranded	mm ²
flexible / Stranded wire with end ferrules	mm ²
Tightening torque range (clamping screw)	
Stripping length / Blade size	mm/-
Note	

Ordering data

Version	
	Dark beige Wemid
Note	

Accessories

End plate / partition	
	Dark beige PA
End bracket	
	Dark beige Wemid
Screwdriver	
	Standard

Marking systems (see assortment in catalogue 7)
Marking tags

For detailed information on other accessories and applications, refer to the „Accessories“ section

MAK 2.5

2.5 mm²

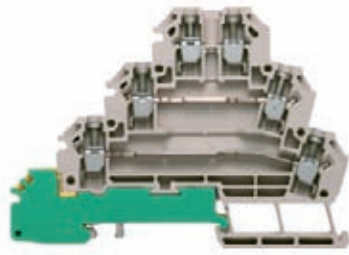

6.2 x 88 x 64	
31 / 4	
0.13...4	

IEC 60947-7-1 (-7-2)		
IEC	UL	CSA
500	300	300
24	10	10
2.5	AWG 26...12	AWG 26...12
6 / 3		
A3 / V-0		
Rated connection		
0.5...4 / 0.5...4		
0.5...4 / 0.5...2.5		
0.4...0.6 Nm (M 2.5)		
8 / 0.6 x 3.5 mm		
With twin ferrules ZH 0.5 to ZH 1.5, rated voltage is 690 V.		

Type	Qty	Order No.
MAK 2.5	50	1615270000

Type	Width	Qty	Order No.
AP MAK2.5 DB	1.5 mm	20	7917000000
WEW 35/1	12 mm	50	1059000000
SDI 0,6x3,5x100		1	9008390000

DEK 5/5

VQB 1.5/50, see chapter „Accessories“

VLI 1.5

1.5 mm²

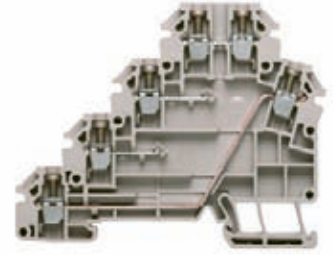

6.2 x 69 x 64	
24 / 4	
0.13...4	

IEC 60947-7-1 (-7-2)		
IEC	UL	CSA
250	300	300
17.5	10	10
1.5	AWG 26...12	AWG 26...12
4 / 3		
A3 / V2		
Rated connection		
0.5...4 / 0.5...2.5		
0.5...4 / 0.5...2.5		
0.4...0.6 Nm (M 2.5)		
8 / 0.6 x 3.5 mm		

Type	Qty	Order No.
VLI 1.5	50	1633250000

Type	Width	Qty	Order No.
AP VLI1.5 DB		20	1784150000
WEW 35/1	12 mm	50	1059000000
SDI 0,6x3,5x100		1	9008390000

DEK 5/5

VQB 1.5/50, see chapter „Accessories“

Plug-in modular terminals

Spade connection

Terminals with cable-lugs acc. to EN 61210 / VDE 0613-6.

In hazardous area applications, the installation instructions and the rated data specifications for accessories given in the technical appendix must be followed.

Width/Length/height with TS35x7.5	mm
max. current / max. cond. cross-section	A/mm ²
Max. clamping range	mm ²



Technical data

Rated data	
Rated voltage	V
Rated current	A
Rated cross-section	mm ²
Rated impulse voltage / Pollution severity	kV/-
Gauge to IEC 60947-1 / UL94 Flammability class	
Approvals	
Clamped conductors (H05V/H07V)	
solid / stranded	mm ²
flexible / Stranded wire with end ferrules	mm ²
Tightening torque range (clamping screw)	
Stripping length / Blade size	mm/-
2 conductors with same cross-section (H05V/H07V)	
solid / stranded	mm ²
flexible / Stranded wire with end ferrules	mm ²
Note	

Ordering data

Version	
	Dark beige Wemid
	Blue Wemid
Note	

Accessories

Screwable cross-connection	
	2-pole
	3-pole
	4-pole
	10-pole
End plate / partition	
	Dark beige Wemid
	Blue Wemid
	Dark beige Wemid
	Blue Wemid
End bracket	
	Dark beige Wemid
Cover	
	With lightning flash symbol
	blank

Marking systems	(see assortment in catalogue 7)
	Marking tags
For detailed information on other accessories and applications, refer to the „Accessories“ section	

WDU 2.5 F

2.5 mm²

Spade connection right

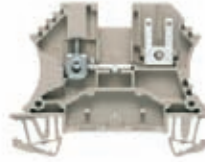

5.1 x 60 x 47	F2,8 F2,8
12 / 4	
0.13...4	

IEC 60947-7-1 / IEC 61210

IEC	UL	CSA
500	300	300
12	10	10
2.5	AWG 26...12	AWG 26...12
6 / 3		
A3 / V-0		
Approvals		
		
Rated connection		Further connection
0.5...4 / 1.5...4		
0.5...4 / 0.5...2.5		0.5...1 / 0.5...2.5
0.4...0.8 Nm (M 2.5)		
10 / 0.6 x 3.5 mm		
2 conductors with same cross-section (H05V/H07V)		
0.5...1.5		
0.5...1.5 / 0.5...1.5		
Note		
With insulating sleeves on cable lug connectors the voltage increases to 500 V. Current is limited by 2.8 mm cable lug connectors with 1 mm ² conductor.		

Type	Qty	Order No.
WDU 2.5 F 2X2.8	100	1021800000
Note		
2.5 mm ² conductor with wire end ferrule plus plastic collar only with collar optimised for diameter (order No. 1333100000, 500 pcs)		

Type	current	Qty	Order No.
WQV 2.5/2	32 A	50	1053660000
WQV 2.5/3	32 A	50	1053760000
WQV 2.5/4	32 A	50	1053860000
WQV 2.5/10	32 A	20	1054460000
Width			
WAP 2.5-10	1.5 mm	50	1050000000
WAP 2.5-10 BL	1.5 mm	50	1050080000
WAP 16+35 WTW 2.5-10	1.5 mm	20	1050100000
WAP 16+35 WTW 2.5-10 BL	1.5 mm	20	1050180000
Width			
WEW 35/2	8 mm	100	1061200000
Width			
WAD 4 GE BED	4 mm	50	1072000000
WAD 4 WS	4 mm	50	1072100000

Type	current	Qty	Order No.
DEK 5/5 / WS 12/5			
Note			
Insulating sleeve for spade connector, 2.8 mm, order No. 0386060000			

WDU 2.5 FF 2*2.8

1 mm²

Spade connection left and right



5.1 x 60 x 47	F2,8 F2,8	F2,8 F2,8
12 / 1		
0.13...1		

IEC 60947-7-1 / IEC 61210

IEC	UL	CSA
500	300	300
12	10	10
1	AWG 22...12	AWG 26...12
6 / 3		
/ V-0		
Approvals		
		
Rated connection		Further connection
0.5...4		
1...1 / 0.5...2.5		
Note		
With insulating sleeves on cable lug connectors the voltage increases to 500 V. Current is limited by 2.8 mm cable lug connectors with 1 mm ² conductor.		

Type	Qty	Order No.
WDU 2.5 FF 2X2.8	100	1021900000
Note		
Technical data relates to 2.8 mm spade connectors with 1 mm ² conductor.		

Type	current	Qty	Order No.
WQV 2.5/2	32 A	50	1053660000
WQV 2.5/3	32 A	50	1053760000
WQV 2.5/4	32 A	50	1053860000
WQV 2.5/10	32 A	20	1054460000
Width			
WAP 2.5-10	1.5 mm	50	1050000000
WAP 2.5-10 BL	1.5 mm	50	1050080000
WAP 16+35 WTW 2.5-10	1.5 mm	20	1050100000
WAP 16+35 WTW 2.5-10 BL	1.5 mm	20	1050180000
Width			
WEW 35/2	8 mm	100	1061200000
Width			
WAD 4 GE BED	4 mm	50	1072000000
WAD 4 WS	4 mm	50	1072100000

Type	current	Qty	Order No.
DEK 5/5 / WS 12/5			
Note			
Insulating sleeve for spade connector, 2.8 mm, order No. 0386060000			

WDK 2.5 F

2.5 mm²

Spade connection right



5.1 x 69.5 x 63
12 / 4
0.13...4

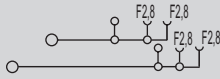

IEC 60947-7-1 / IEC 61210

IEC	UL	CSA
400	300	300
12	10	10
2.5	AWG 22...12	AWG 26...12
6 / 3		
A3 / V-0		

Rated connection		Further connection
0.5...4 / 1.5...4		
0.5...4 / 0.5...2.5		1...1
0.4...0.6 Nm (M 2.5)		
10 / 0.6 x 3.5 mm		
0.5...1.5		
0.5...1.5 / 0.5...1.5		
With insulating sleeves on cable lug connectors the voltage increases to 500 V. Current is limited by 2.8 mm cable lug connectors with 1 mm ² conductor.		

Type	Qty	Order No.
WDK 2.5 F	100	1021600000
WDK 2.5 F BL	100	1021680000
2.5 mm ² conductor with wire end ferrule plus plastic collar only with collar optimised for diameter (order No. 1333100000, 500 pcs)		

Type	current	Qty	Order No.
WQV 2.5/2	32 A	50	1053660000
WQV 2.5/3	32 A	50	1053760000
WQV 2.5/4	32 A	50	1053860000
WQV 2.5/10	32 A	20	1054460000
Width			
WAP WDK2.5	1.5 mm	20	1059100000
WAP WDK2.5 BL	1.5 mm	20	1059180000
WTW EN	3 mm	20	1058800000
WEW 35/2	8 mm	100	1061200000
WAD 4 GE BED	4 mm	50	1072000000
WAD 4 WS	4 mm	50	1072100000

DEK 5/5 / WS 8/5
 Insulating sleeve for spade connector, 2.8 mm, order No. 0386060000

WDK 2.5 FF

1 mm²

Spade connection left and right



5.1 x 75.5 x 63
12 / 1
0.13...1

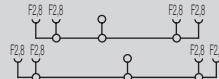

IEC 60947-7-1 / IEC 61210

IEC	UL	CSA
400	300	300
12	10	10
1	AWG 22...12	AWG 26...12
6 / 3		
/ V-0		

Rated connection		Further connection
0.5...4		
1...1		
0.4...0.6 Nm (M 2.5)		
10 / 0.6 x 3.5 mm		
0.5...1.5		
0.5...1.5 / 0.5...1.5		
With insulating sleeves on cable lug connectors the voltage increases to 500 V. Current is limited by 2.8 mm cable lug connectors with 1 mm ² conductor.		

Type	Qty	Order No.
WDK 2.5 FF	100	1021700000

Type	current	Qty	Order No.
WQV 2.5/2	32 A	50	1053660000
WQV 2.5/3	32 A	50	1053760000
WQV 2.5/4	32 A	50	1053860000
WQV 2.5/10	32 A	20	1054460000
Width			
WAP WDK2.5	1.5 mm	20	1059100000
WAP WDK2.5 BL	1.5 mm	20	1059180000
WTW EN	3 mm	20	1058800000
WEW 35/2	8 mm	100	1061200000
WAD 4 GE BED	4 mm	50	1072000000
WAD 4 WS	4 mm	50	1072100000

DEK 5/5 / WS 8/5
 Insulating sleeve for spade connector, 2.8 mm, order No. 0386060000

WDK 2.5 FV

2.5 mm²

Spade connection right, both levels at one potential

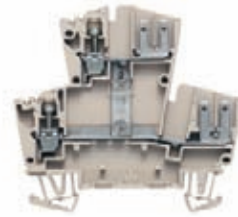

5.1 x 69.5 x 63
12 / 4
0.13...4



IEC 60947-7-1 / IEC 61210

IEC	UL	CSA
400	300	300
12	10	10
2.5	AWG 22...12	AWG 26...12
6 / 3		
A3 / V-0		

Rated connection		Further connection
0.5...4 / 1.5...4		
0.5...4 / 0.5...2.5		1...1 / 0.5...2.5
0.4...0.6 Nm (M 2.5)		
10 / 0.6 x 3.5 mm		
0.5...1.5		
0.5...1.5 / 0.5...1.5		
With insulating sleeves on cable lug connectors the voltage increases to 500 V. Current is limited by 2.8 mm cable lug connectors with 1 mm ² conductor.		

Type	Qty	Order No.
WDK 2.5 FV	100	1022400000
2.5 mm ² conductor with wire end ferrule plus plastic collar only with collar optimised for diameter (order No. 1333100000, 500 pcs)		

Type	current	Qty	Order No.
WQV 2.5/2	32 A	50	1053660000
WQV 2.5/3	32 A	50	1053760000
WQV 2.5/4	32 A	50	1053860000
WQV 2.5/10	32 A	20	1054460000
Width			
WAP WDK2.5	1.5 mm	20	1059100000
WAP WDK2.5 BL	1.5 mm	20	1059180000
WTW EN	3 mm	20	1058800000
WEW 35/2	8 mm	100	1061200000
WAD 4 GE BED	4 mm	50	1072000000
WAD 4 WS	4 mm	50	1072100000

DEK 5/5 / WS 8/5
 Insulating sleeve for spade connector, 2.8 mm, order No. 0386060000

Plug-in modular terminals

Plug-in connection

In hazardous area applications, the installation instructions and the rated data specifications for accessories given in the technical appendix must be followed.

Width/Length/height with TS35x7.5	mm
max. current / max. cond. cross-section	A/mm ²
Max. clamping range	mm ²

Technical data

Rated data	
Rated voltage	V
Rated current	A
Rated cross-section	mm ²
Rated impulse voltage / Pollution severity	kV/-
Gauge to IEC 60947-1 / UL94 Flammability class	
Approvals	
Clamped conductors (H05V/H07V)	
solid / stranded	mm ²
flexible / Stranded wire with end ferrules	mm ²
Tightening torque range (clamping screw)	
Stripping length / Blade size	mm/-
2 conductors with same cross-section (H05V/H07V)	
solid / stranded	mm ²
flexible / Stranded wire with end ferrules	mm ²
Note	

Ordering data

Version	Note
Dark beige Wemid	

Accessories

Screwable cross-connection	
	2-pole
	3-pole
	4-pole
	10-pole
End plate / partition	
	With assembly peg
	Without peg
Mounting block for socket connector	
	With assembly peg
	Without peg
Socket blocks	
	4-pole
	6-pole
	8-pole
	(with lateral dovetail) 4-pole
	(with lateral dovetail) 6-pole
	(with lateral dovetail) 8-pole
Miscellaneous accessories	
	Cover for unused pins
	Coding element

Marking systems	For detailed information on other accessories and applications, refer to the „Accessories“ section
(see assortment in catalogue 7)	
Marking tags	

WDU 1.5 BLZ 5.08 WQV

1.5 mm²

Screwable cross-connection

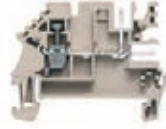

5.1 x 49 x 37.5	WQV	BLZ 5.08
16 / 4		
0.13...4		

IEC 60947-7-1 / IEC 61984		
IEC	UL	CSA
250	300	300
16	20	10
1.5	AWG 26...16	AWG 26...16
4 / 3		
A3 / V-0		
UL		
Rated connection		Plug-in connection
0.5...4 / 1.5...4		0.5...2.5 / 1.5...2.5
0.5...4 / 0.5...2.5		0.5...2.5 / 0.5...2.5
0.4...0.6 Nm (M 2.5)		
10 / 0.6 x 3.5 mm		
0.5...1.5		
0.5...1.5 / 0.5...1.5		
Size with BLZ socket connector: length 57.5 mm / height 50 mm		

Type	Qty	Order No.
WDU 1.5/BLZ 5.08	100	1577340000
WDU 1.5 BLA order no. 1577260000 (100 pcs.). Techn. data same as WDU 1.5 BLZ.		

Type	current	Qty	Order No.
WQV 2.5/2	32 A	50	1053660000
WQV 2.5/3	32 A	50	1053760000
WQV 2.5/4	32 A	50	1053860000
WQV 2.5/10	32 A	20	1054460000
Width			
WAP WDU1.5/BLZ/ZA	2.5 mm	50	1577320000
WAP WDU1.5/BLZ	2.5 mm	50	1577330000
Width			
WBB ZA WDU1.5/BL 10/10		10	1068260000
WBB WDU1.5/BL...		10	1068160000
Width			
BLZ 5.08/4 SN OR		100	1526660000
BLZ 5.08/6 SN OR		50	1526860000
BLZ 5.08/8 SN OR		50	1527060000
BLZ 5.08/4B SN OR		100	1528960000
BLZ 5.08/6B SN OR		50	1529160000
BLZ 5.08/8B SN OR		50	1529360000
Width			
WAD WDU1.5/BL		20	1577400000
BLZ-KO SW		50	1545710000

Marking systems	For detailed information on other accessories and applications, refer to the „Accessories“ section
DEK 5/5 / WS 12/5	
2.5 mm ² conductor with wire end ferrule plus plastic collar only with collar optimised for diameter (order No. 1333100000, 500 pcs)	

WDU 1.5 BLZ 5.08 ZQV

1.5 mm²

Plug-in cross-connection



5.1 x 49 x 37.5	ZQV	BLZ 5.08
16 / 4		
0.13...4		

IEC 60947-7-1 / IEC 61984		
IEC	UL	CSA
250	300	300
16	20	10
1.5	AWG 26...16	AWG 26...16
4 / 3		
A3 / V-0		
UL		
Rated connection		Plug-in connection
0.5...4 / 1.5...4		0.5...2.5 / 1.5...2.5
0.5...4 / 0.5...2.5		0.5...2.5 / 0.5...2.5
0.4...0.6 Nm (M 2.5)		
10 / 0.6 x 3.5 mm		
0.5...1.5		
0.5...1.5 / 0.5...1.5		
Size with BLZ socket connector: length 57.5 mm / height 50 mm		

Type	Qty	Order No.
WDU 1.5/ZQV/BLZ 5.08	100	1784460000

Type	Qty	Order No.
WAP WDU1.5/BLZ/ZA	2.5 mm	50
WAP WDU1.5/BLZ	2.5 mm	50
Width		
WBB ZA WDU1.5/BL 10/10		10
WBB WDU1.5/BL...		10
Width		
BLZ 5.08/4 SN OR		100
BLZ 5.08/6 SN OR		50
BLZ 5.08/8 SN OR		50
BLZ 5.08/4B SN OR		100
BLZ 5.08/6B SN OR		50
BLZ 5.08/8B SN OR		50
Width		
WAD WDU1.5/BL		20
BLZ-KO SW		50

Marking systems	For detailed information on other accessories and applications, refer to the „Accessories“ section
DEK 5/5 / WS 12/5	
2.5 mm ² conductor with wire end ferrule plus plastic collar only with collar optimised for diameter (order No. 1333100000, 500 pcs)	

WDK 2.5 BLZ/5.08

2.5 mm²

Double terminal pitch 5.08



5.1 x 58 x 53
18 / 4
0.13...4



IEC 60947-7-1 / IEC 61984

IEC	UL	CSA
250	300	300
16.5	10	24
2.5	AWG 22...12	AWG 26...10
4 / 3		
A3 / V-0		

Rated connection		Plug-in connection	
0.5...4 / 1.5...2.5	0.5...2.5 / 1.5...2.5	0.5...2.5 / 1.5...2.5	0.5...2.5 / 1.5...2.5
0.4...0.8 Nm (M 2.5)	0.5...2.5 / 0.5...2.5	0.4...0.8 Nm (M 2.5)	0.5...2.5 / 0.5...2.5
10 / 0.6 x 3.5 mm			
0.5...1.5			
0.5...1.5 / 0.5...1.5			
Size with BLZ socket connector: length 58 mm / height 63.5 mm			

Type	Qty	Order No.
WDK 2.5/BLZ/5.08/ZA	100	1034400000
2.5 mm ² conductor with wire end ferrule plus plastic collar only with collar optimised for diameter (order No. 1333100000, 500 pcs)		

Type	Qty	Order No.
Width		
WAP WDK2.5/BLZ/M.ZA	20	1070100000
WAP WDK2.5/BLZ/O.ZA	20	1070000000
WBB ZA WDK2.5/BL5.08	10	1072760000
WBB WDK2.5/BL5.08	10	1072660000
BLZ 5.08/4 SN OR	100	1526660000
BLZ 5.08/6 SN OR	50	1526860000
BLZ 5.08/8 SN OR	50	1527060000
BLZ 5.08/4B SN OR	100	1528960000
BLZ 5.08/6B SN OR	50	1529160000
BLZ 5.08/8B SN OR	50	1529360000
WAD WDU1.5/BL	20	1577400000
BLZ-KO SW	50	1545710000

DEK 5/5 / WS 8/5
For external cross-connection WQB A, see section W-series accessories „Electrical distribution“.

WDU 2.5 BLZ/7.62

2.5 mm²

Pitch 7.62



7.6 x 49 x 37.5
24 / 4
0.13...4



IEC 60947-7-1 / IEC 61984

IEC	UL	CSA
400		
21.5		
2.5		
6 / 3		
A3 / V-0		

Rated connection		Plug-in connection	
0.5...4 / 1.5...2.5	0.5...2.5 / 1.5...2.5	0.5...2.5 / 1.5...2.5	0.5...2.5 / 1.5...2.5
0.5...4 / 0.5...2.5	0.5...2.5 / 0.5...2.5	0.4...0.8 Nm (M 2.5)	0.5...2.5 / 0.5...2.5
10 / 0.6 x 3.5 mm			
0.5...1.5			
0.5...1.5 / 0.5...1.5			
Size with BLZ socket connector: length 57.5 mm / height 50 mm			

Type	Qty	Order No.
WDU 2.5/BLZ/7.62	100	1038900000
2.5 mm ² conductor with wire end ferrule plus plastic collar only with collar optimised for diameter (order No. 1333100000, 500 pcs)		

Type	Qty	Order No.
Width		
WAP WDU1.5/BLZ/ZA	50	1577320000
WAP WDU1.5/BLZ	50	1577330000
WBB ZA WDU2.5/BLZ7.62	10	1073600000
WBB WDU2.5/BLZ7.62	10	1073500000
BLZ 7.62/4 SN OR	100	1623070000
BLZ 7.62/6 SN OR	50	1623090000
BLZ 7.62/8 SN OR	40	1623110000
WAD WDU1.5/BL	20	1577400000
BLZ-KO SW	50	1545710000

DEK 5/5 / WS 12/6,5

WDK 2.5 BLZ/7.62

2.5 mm²

Double terminal pitch 7.62

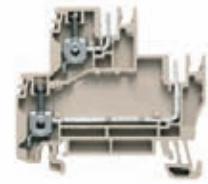

7.6 x 58 x 53
20 / 4
0.13...4

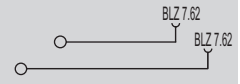

IEC 60947-7-1 / IEC 61984

IEC	UL	CSA
400		
18.5		
2.5		
6 / 3		
A3 / V-0		

Rated connection		Plug-in connection	
0.5...4 / 1.5...4	0.5...2.5 / 1.5...2.5	0.5...2.5 / 1.5...2.5	0.5...2.5 / 1.5...2.5
0.5...4 / 0.5...2.5	0.5...2.5 / 0.5...2.5	0.4...0.8 Nm (M 2.5)	0.5...2.5 / 0.5...2.5
10 / 0.6 x 3.5 mm			
0.5...1.5			
0.5...1.5 / 0.5...1.5			
Size with BLZ socket connector: length 58 mm / height 63.5 mm			

Type	Qty	Order No.
WDK 2.5 BLZ/7.62/ZA	50	1038500000
2.5 mm ² conductor with wire end ferrule plus plastic collar only with collar optimised for diameter (order No. 1333100000, 500 pcs)		

Type	Qty	Order No.
Width		
WAP WDK2.5/BLZ/M.ZA	20	1070100000
WAP WDK2.5/BLZ/O.ZA	20	1070000000
WBB ZA WDK2.5/BLZ7.62	10	1072960000
WBB WDK2.5/BLZ7.62	10	1072860000
BLZ 7.62/4 SN OR	100	1623070000
BLZ 7.62/6 SN OR	50	1623090000
BLZ 7.62/8 SN OR	40	1623110000
BLZ 7.62/4B SN OR	100	1623400000
BLZ 7.62/6B SN OR	50	1623420000
BLZ 7.62/8B SN OR	40	1623440000
WAD WDU1.5/BL	20	1577400000
BLZ-KO SW	50	1545710000

DEK 5/5 / WS 12/6,5
For external cross-connection WQB A, see section W-series accessories „Electrical distribution“.

Terminals for temperature measuring circuits

Thermocouple terminals

WDU 2.5/TC

2.5 mm²

In hazardous area applications, the installation instructions and the rated data specifications for accessories given in the technical appendix must be followed.

Width/Length/height with TS35x7.5	mm
max. current / max. cond. cross-section	A/mm ²
Max. clamping range	mm ²

10.2 x 60 x 50.5
/ 2.5
0.13...2.5

Technical data

Rated data	
Rated voltage	V
Rated current	A
Rated cross-section	mm ²
Rated impulse voltage / Pollution severity	kV/-
Gauge to IEC 60947-1 / UL94 Flammability class	
Approvals	
Clamped conductors (H05V/H07V)	
solid / stranded	mm ²
flexible / Stranded wire with end ferrules	mm ²
Tightening torque range (clamping screw)	
Stripping length / Blade size	mm/-
2 conductors with same cross-section (H05V/H07V)	
solid / stranded	mm ²
flexible / Stranded wire with end ferrules	mm ²
Note	

IEC 60947-7-1 / IEC 60584				Ex e ll		II 2 G D	
IEC	UL	CSA	EN 60079-7				
			55				
			1				
2.5			2.5				
			/ 3				
			A2 / V-0				
			SIRA 02ATEX3153 U				
Rated connection							
0.5...2.5 / 1.5...2.5							
0.5...2.5 / 0.5...2.5							
0.4...0.6 Nm (M 2.5)							
10 / 0.6 x 3.5 mm							
0.5...1.5							
0.5...1.5 / 0.5...1.5							

Ordering data

Version	
	(NiCr - Ni) type K
	(Cu - CuNi) type T
	(Fe-CuNi) type J
	(Pt 10% - Pt Rh/Pt 13% - Pt Rh) type SR
	(Pt 10% Rh - Pt 6% Rh) type B
	(NiCr - CuNi) type E
	(NiSiI - Nicrosil) type N
Note	

Type	Qty	Order No.
WDU 2.5/TC TYP K	50	1024100000
WDU 2.5/TC TYP T	50	1024200000
WDU 2.5/TC TYP J	50	1024300000
WDU 2.5/TC TYP SR	50	1024400000
WDU 2.5/TC TYP B	50	1033700000
WDU 2.5/TC TYP E	50	1033300000
WDU 2.5/TC TYP N	50	1041500000

Accessories

End plate / partition	
	Dark beige Wemid
	Dark beige Wemid
End bracket	
	Dark beige Wemid

Type	Width	Qty	Order No.
WAP 2.5-10	1.5 mm	50	1050000000
WAP 16+35 WTW 2.5-10	1.5 mm	20	1050100000
WEW 35/2	8 mm	100	1061200000

Marking systems (see assortment in catalogue 7)
Marking tags

For detailed information on other accessories and applications, refer to the „Accessories“ section

DEK 5/5 / WS 12/5

Weidmüller thermocouple terminals are specially designed for the transmission of very small voltages in temperature measuring circuits. Special current bars ensure that no false signals are transmitted within the terminal when temperature differences between the positive and negative paths exist. This high measuring precision is required, for example, in aircraft engine test rigs, complicated chemical processes, controllers, etc.

- Material of current bar corresponds to thermal and compensating conductors
- Clear thermocouple marking
- 2-pole blocks per thermocouple
- Modular width 10 mm

Configuration of a temperature measuring circuit

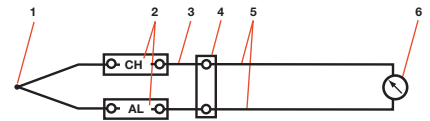

- 1 Thermocouple (sensor)
- 2 Thermocouple terminals
- 3 Compensating conductor
- 4 Reference junction
- 5 Supply and return conductors
- 6 Measuring instrument

The thermocouple terminals shown in this measuring circuit are used for the thermoelectrical transmission of the thermoelectric voltage from the thermocouple to the reference junction and the indicator unit via the compensating conductor. Thermocouple terminals are required for constructing a temperature measuring circuit.

Technical data

Thermocouples to IEC 584 (DIN 43 710)

	Current bar
	Cromel Alumel
	E-grade copper (ETP) / Constantan
	Iron Constantan
	E-copper/ A-grade copper
	S-grade copper (OFC) / E-copper
	Cromel- Constantan

Modular terminals with electronic components are available for a number of standard applications. Other versions to customer specification are available upon request.

In hazardous area applications, the installation instructions and the rated data specifications for accessories given in the technical appendix must be followed.

Width/Length/height with TS35x7.5	mm
max. current / max. cond. cross-section	A/mm ²
Max. clamping range	mm ²

Technical data

Rated data	
Rated voltage	V
Rated current	A
Rated cross-section	mm ²
Rated impulse voltage / Pollution severity	kV/-
Gauge to IEC 60947-1 / UL94 Flammability class	
Approvals	

Clamped conductors (H05V/H07V)

solid / stranded	mm ²
flexible / Stranded wire with end ferrules	mm ²
Tightening torque range (clamping screw)	
Stripping length / Blade size	mm/-

2 conductors with same cross-section (H05V/H07V)

solid / stranded	mm ²
flexible / Stranded wire with end ferrules	mm ²

Note

Ordering data

Version	Dark beige Wemid
---------	------------------

Note

Accessories

Intermediate frame	Thickness 2,5 mm
Busbar	1 m

Marking systems	(see assortment in catalogue 7) Marking tags
------------------------	---

For detailed information on other accessories and applications, refer to the „Accessories“ section

WPO 4

4 mm²

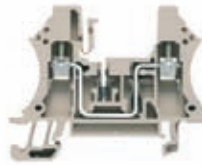

6 x 60 x 47	
32 / 4	
0.13...4	

IEC 60947-7-1

IEC	UL	CSA
250	300	300
32	10	10
4	AWG 26...12	AWG 26...12
	4 / 3	
	A3 / V-0	



Rated connection

0.5...4	
0.5...4 / 0.5...2.5	/ 0.5...4
0.5...1.0 Nm (M 3)	
8 / 0.6 x 3.5 mm	

0.5...1.5	mm ²
0.5...1.5	mm ²

The tightening torque is 2 Nm when connecting two conductors.

Type	Qty	Order No.
WPO 4	50	103600000

Type	Width	Qty	Order No.
ZR WPO4 DB		20	1071100000
SSCH 7.3X1.2X1000	7.3 mm	1	107120000

WPO 4 with varistor

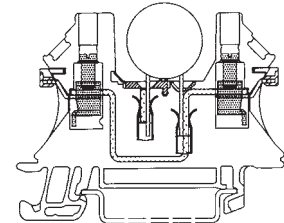

Weidmüller varistor terminals have been designed for the retrofitting of electronic components, e.g. varistors, diodes, gas discharge tubes, etc. These “electronic terminals” no longer have to be configured prior to installation for subsequent delivery with soldered components which can no longer be distinguished.

The significant advantages of this design are:

- **Cost saving:**
Components can be changed quickly on site. Service requires only a visual inspection.
- **Clarity:**
Components are easy to distinguish.
- **Flexibility:**
Components can immediately be adapted to changed conditions.

Note:

Never change electronic components in energised systems!

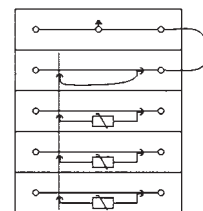

Overvoltages in a 3-phase supply discharged to earth via WPE 4 with the aid of varistors and a gas discharge tube.

Terminals with electronic components

Modular terminals with electronic components are available for a number of standard applications. Other versions to customer specification are available upon request.

In hazardous area applications, the installation instructions and the rated data specifications for accessories given in the technical appendix must be followed.

Width/Length/height with TS35x7.5	mm
max. current / max. cond. cross-section	A/mm ²
Max. clamping range	mm ²

Technical data

Rated data	
Rated cross-section	mm ²
Gauge to IEC 60947-1 / UL94 Flammability class	
Approvals	
Clamped conductors (H05V/H07V)	
solid / stranded	mm ²
flexible / Stranded wire with end ferrules	mm ²
Tightening torque range (clamping screw)	
Stripping length / Blade size	mm/-

Note

Ordering data

Version	
	10 Ω
	500 Ω
	1 kΩ
	5 kΩ
	50 kΩ
	2 MΩ

Note

Accessories

End plate / partition	
	Dark beige Wemid
	Dark beige Wemid
End bracket	
	Dark beige Wemid
	Dark beige Wemid
Screwdriver	
	with „swifty set“ cutting device
	Standard
Shield bus	

Marking systems (see assortment in catalogue 7)
Marking tags

For detailed information on other accessories and applications, refer to the „Accessories“ section

WDUL 4/...

4 mm²

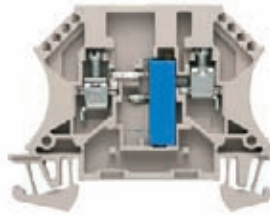

6.5 x 60 x 47
/ 6
0.13...6

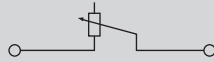

IEC 60947- 7- 1

IEC	UL	CSA
4		
	A4 / V-0	



Rated connection

0.5...6
0.5...4 / 0.5...2.5
0.6...0.8 Nm (M 3)
9 / 0.6 x 3.5 mm

Type	Qty	Order No.
WDUL 4/10	10	1027000000
WDUL 4/500	10	1027400000
WDUL 4/1K	10	1027500000
WDUL 4/5K	10	1027600000
WDUL 4/50K	10	1027800000
WDUL 4/500K	10	1028000000

Type	Width	Qty	Order No.
WAP 2.5-10	1.5 mm	50	1050000000
WAP 16+35 WTW 2.5-10	1.5 mm	20	1050100000
WEW 35/2	8 mm	100	1061200000
EW 35	8.5 mm	50	0383560000
SWIFTY SET		1	9006060000
SD 0.6x3.5x100		1	9008330000
LS 2.8 WDU2.5-10		100	1056400000

Technical data for the 30-Ω compensating resistor

Resistor material: "Cermet"
Resistor setting range: 0...30 Ω
Wave form: linear

Temperature coefficient: 100 ppm/°C

Mechanical lifespan: 200 operations without permissible deviations, across the entire resistance range

Resistance change per spindle turn: ≈ 1,2 Ω

Rated output for total resistance: 1 watt at 70 °C

Rated current: 120 mA

Ambient temperature: -55 °C to +70 °C

Ingress (seal) protection:

- 1) Leak tested in water at 70 °C without bubble formation
- 2) Storage in SFW 2.0 S, acc. to DIN 50018, 9 cycles

Capacity expressed in % of rated load

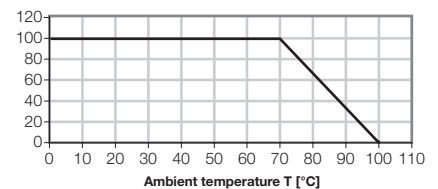

Modular terminals with electronic components are available for a number of standard applications. Other versions to customer specification are available upon request.

In hazardous area applications, the installation instructions and the rated data specifications for accessories given in the technical appendix must be followed.

Width/Length/height with TS35x7.5	mm
max. current / max. cond. cross-section	A/mm ²
Max. clamping range	mm ²

Technical data

Rated data	
Rated voltage	V
Rated current	A
Rated cross-section	mm ²
Rated impulse voltage / Pollution severity	kV/-
Gauge to IEC 60947-1 / UL94 Flammability class	
Approvals	
Electronic fixtures	
Component voltage / Component current	V/A
Operating voltage for display, max. / Current	V/A
Clamped conductors (H05V/H07V)	
solid / stranded	mm ²
flexible / Stranded wire with end ferrules	mm ²
Tightening torque range (clamping screw)	
Stripping length / Blade size	mm/-
Note	

Ordering data

Version	
	Dark beige Wemid
	Dark beige Wemid (red LED)
	Dark beige Wemid (green LED)
Note	

Accessories

Screwable cross-connection	
	2-pole
	3-pole
	4-pole
	10-pole
End plate / partition	
	Dark beige Wemid
End bracket	
	Dark beige Wemid
Screwdriver	
	with „swifty set“ cutting device
	Standard

Marking systems	
	(see assortment in catalogue 7)
	Marking tags
For detailed information on other accessories and applications, refer to the „Accessories“ section	

WDK 2.5/D

2.5 mm²

Reverse polarity protection



5.1 x 69 x 63	
10 / 4	
0.05...4	

IEC 60947-7-1		
IEC	UL	CSA
400	300	300
10	10	10
2.5	AWG 30...12	AWG 26...12
	6 / 3	
	A3 / V-0	
1000 / 1		
Rated connection		
0.5...4 / 1.5...4		
0.5...4 / 0.5...2.5		
0.4...0.6 Nm (M 2.5)		
10 / 0.6 x 3.5 mm		
Rated current is 10 A for continuous busbars only. Diode 1 N 4007		

Type	Qty	Order No.
WDK 2.5 1D	25	8025610000
2.5 mm ² conductor with wire end ferrule plus plastic collar only with collar optimised for diameter (order No. 1333100000, 500 pcs)		

Type	current	Qty	Order No.
WQV 2.5/2	32 A	50	1053660000
WQV 2.5/3	32 A	50	1053760000
WQV 2.5/4	32 A	50	1053860000
WQV 2.5/10	32 A	20	1054460000
Width			
WAP WDK2.5	1.5 mm	20	1059100000
WEW 35/2	8 mm	100	1061200000
SWIFTY SET			
SWIFTY SET		1	9006060000
SD 0.6x3.5x100		1	9008330000

Marking systems	
	DEK 5/5 / WS 8/5

WDK 2.5/D/1

2.5 mm²

Suppression circuit e. g. for contactor



5.1 x 69 x 63	
10 / 4	
0.05...4	

IEC 60947-7-1		
IEC	UL	CSA
400	300	300
10	10	10
2.5	AWG 30...12	AWG 26...12
	6 / 3	
	A3 / V-0	
1000 / 1		
Rated connection		
0.5...4 / 1.5...4		
0.5...4 / 0.5...2.5		
0.4...0.6 Nm (M 2.5)		
10 / 0.6 x 3.5 mm		
Rated current is 10 A for continuous busbars only. Diode 1 N 4007		

Type	Qty	Order No.
WDK 2.5 1D A.1	25	1023400000
2.5 mm ² conductor with wire end ferrule plus plastic collar only with collar optimised for diameter (order No. 1333100000, 500 pcs)		

Type	current	Qty	Order No.
WQV 2.5/2	32 A	50	1053660000
WQV 2.5/3	32 A	50	1053760000
WQV 2.5/4	32 A	50	1053860000
WQV 2.5/10	32 A	20	1054460000
Width			
WAP WDK2.5	1.5 mm	20	1059100000
WEW 35/2	8 mm	100	1061200000
SWIFTY SET			
SWIFTY SET		1	9006060000
SD 0.6x3.5x100		1	9008330000

Marking systems	
	DEK 5/5 / WS 8/5

Terminals with electronic components

Modular terminals with electronic components are available for a number of standard applications. Other versions to customer specification are available upon request.

In hazardous area applications, the installation instructions and the rated data specifications for accessories given in the technical appendix must be followed.

Width/Length/height with TS35x7.5	mm
max. current / max. cond. cross-section	A/mm ²
Max. clamping range	mm ²

Technical data

Rated data	
Rated voltage	V
Rated current	A
Rated cross-section	mm ²
Rated impulse voltage / Pollution severity	kV/-
Gauge to IEC 60947-1 / UL94 Flammability class	
Approvals	
Electronic fixtures	
Component voltage / Component current	V/A
Operating voltage for display, max. / Current	V/A
Clamped conductors (H05V/H07V)	
solid / stranded	mm ²
flexible / Stranded wire with end ferrules	mm ²
Tightening torque range (clamping screw)	
Stripping length / Blade size	mm/-
Note	

Ordering data

Version	
	Dark beige Wemid
	Dark beige Wemid (red LED)
	Dark beige Wemid (green LED)
Note	

Accessories

Screwable cross-connection	
	2-pole
	3-pole
	4-pole
	10-pole
End plate / partition	
	Dark beige Wemid
End bracket	
	Dark beige Wemid
Screwdriver	
	with „swifty set“ cutting device
	Standard

Marking systems	(see assortment in catalogue 7)
	Marking tags
For detailed information on other accessories and applications, refer to the „Accessories“ section	

WDK 2.5/D/2

2.5 mm²

Suppression circuit e. g. for contactor



5.1 x 69 x 63	
10 / 4	
0.05...4	

IEC 60947-7-1			
IEC	UL	CSA	
400	300	300	
10	10	10	
2.5	AWG 30...12	AWG 26...12	
6 / 3			
A3 / V-0			
			
1000 / 1			
Rated connection			
0.5...4 / 1.5...4			
0.5...4 / 0.5...2.5			
0.4...0.6 Nm (M 2.5)			
10 / 0.6 x 3.5 mm			
Rated current is 10 A for continuous busbars only. Diode 1 N 4007			

Type	Qty	Order No.
WDK 2.5 1D A.2	25	1023300000
2.5 mm ² conductor with wire end ferrule plus plastic collar only with collar optimised for diameter (order No. 1333100000, 500 pcs)		

Type	current	Qty	Order No.
WQV 2.5/2	32 A	50	1053660000
WQV 2.5/3	32 A	50	1053760000
WQV 2.5/4	32 A	50	1053860000
WQV 2.5/10	32 A	20	1054460000
Width			
WAP WDK2.5	1.5 mm	20	1059100000
WEW 35/2	8 mm	100	1061200000
Width			
SWIFTY SET		1	9006060000
SD 0.6x3.5x100		1	9008330000

Marking systems	(see assortment in catalogue 7)
	DEK 5/5 / WS 8/5
For detailed information on other accessories and applications, refer to the „Accessories“ section	

WDK 2.5/D/4

2.5 mm²

Lamp test circuits

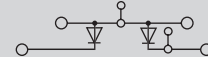

5.1 x 69 x 63	
10 / 4	
0.05...4	

IEC 60947-7-1			
IEC	UL	CSA	
400	300	300	
10	10	10	
2.5	AWG 30...12	AWG 26...12	
6 / 3			
A3 / V-0			
			
1000 / 1			
Rated connection			
0.5...4 / 1.5...4			
0.5...4 / 0.5...2.5			
0.4...0.6 Nm (M 2.5)			
10 / 0.6 x 3.5 mm			
Rated current is 10 A for continuous busbars only. Diode 1 N 4007			

Type	Qty	Order No.
WDK 2.5 2D	25	8014670000
2.5 mm ² conductor with wire end ferrule plus plastic collar only with collar optimised for diameter (order No. 1333100000, 500 pcs)		

Type	current	Qty	Order No.
WQV 2.5/2	32 A	50	1053660000
WQV 2.5/3	32 A	50	1053760000
WQV 2.5/4	32 A	50	1053860000
WQV 2.5/10	32 A	20	1054460000
Width			
WAP WDK2.5	1.5 mm	20	1059100000
WEW 35/2	8 mm	100	1061200000
Width			
SWIFTY SET		1	9006060000
SD 0.6x3.5x100		1	9008330000

Marking systems	(see assortment in catalogue 7)
	DEK 5/5 / WS 8/5
For detailed information on other accessories and applications, refer to the „Accessories“ section	

WDK 2.5/D/5

2.5 mm²

Lamp test circuits



5.1 x 69 x 63
10 / 4
0.05...4



IEC 60947-7-1

IEC	UL	CSA
400	300	300
10	10	10
2.5	AWG 30...12	AWG 26...12
6 / 3		
A3 / V-0		



1000 / 1

Rated connection

0.5...4 / 1.5...4
0.5...4 / 0.5...2.5
0.4...0.6 Nm (M 2.5)
10 / 0.6 x 3.5 mm

Rated current is 10 A for continuous busbars only. **Diode 1 N 4007**

Type	Qty	Order No.
WDK 2.5 2D	25	1022600000

2.5 mm² conductor with wire end ferrule plus plastic collar only with collar optimised for diameter (order No. 1333100000, 500 pcs)

Type	current	Qty	Order No.
WQV 2.5/2	32 A	50	1053660000
WQV 2.5/3	32 A	50	1053760000
WQV 2.5/4	32 A	50	1053860000
WQV 2.5/10	32 A	20	1054460000
Width			
WAP WDK2.5	1.5 mm	20	1059100000
WEW 35/2	8 mm	100	1061200000
SWIFTY SET		1	9006060000
SD 0.6x3.5x100		1	9008330000

DEK 5/5 / WS 8/5

WDK 2.5/D/6

2.5 mm²

Lamp test circuits



5.1 x 69 x 63
10 / 4
0.05...4

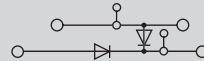

IEC 60947-7-1

IEC	UL	CSA
400	300	300
10	10	10
2.5	AWG 30...12	AWG 26...12
6 / 3		
A3 / V-0		



1000 / 1

Rated connection

0.5...4 / 1.5...4
0.5...4 / 0.5...2.5
0.4...0.6 Nm (M 2.5)
10 / 0.6 x 3.5 mm

Rated current is 10 A for continuous busbars only.

Type	Qty	Order No.
WDK 2.5 2D	25	1023500000

2.5 mm² conductor with wire end ferrule plus plastic collar only with collar optimised for diameter (order No. 1333100000, 500 pcs)

Type	current	Qty	Order No.
WQV 2.5/2	32 A	50	1053660000
WQV 2.5/3	32 A	50	1053760000
WQV 2.5/4	32 A	50	1053860000
WQV 2.5/10	32 A	20	1054460000
Width			
WAP WDK2.5	1.5 mm	20	1059100000
WEW 35/2	8 mm	100	1061200000
SWIFTY SET		1	9006060000
SD 0.6x3.5x100		1	9008330000

DEK 5/5 / WS 8/5

WDK 2.5E w/o elec.

2.5 mm²

For installing electronic components



5.1 x 69 x 63
10 / 4
0.05...4

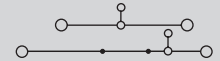

IEC 60947-7-1

IEC	UL	CSA
400		
10		
2.5		
6 / 3		
A3 / V-0		



1000 / 1

Rated connection

0.5...4 / 1.5...4
0.5...4 / 0.5...2.5
0.4...0.6 Nm (M 2.5)
10 / 0.6 x 3.5 mm

Rated current is 10 A for continuous busbars only.

Type	Qty	Order No.
WDK 2.5/D	100	1023200000

2.5 mm² conductor with wire end ferrule plus plastic collar only with collar optimised for diameter (order No. 1333100000, 500 pcs)

Type	current	Qty	Order No.
WQV 2.5/2	32 A	50	1053660000
WQV 2.5/3	32 A	50	1053760000
WQV 2.5/4	32 A	50	1053860000
WQV 2.5/10	32 A	20	1054460000
Width			
WAP WDK2.5	1.5 mm	20	1059100000
WEW 35/2	8 mm	100	1061200000
SWIFTY SET		1	9006060000
SD 0.6x3.5x100		1	9008330000

DEK 5/5 / WS 8/5

Terminals with electronic components

In hazardous area applications, the installation instructions and the rated data specifications for accessories given in the technical appendix must be followed.

Width/Length/height with TS35x7.5	mm
max. current / max. cond. cross-section	A/mm ²
Max. clamping range	mm ²

Technical data

Rated data	
Rated voltage	V
Rated current	A
Rated cross-section	mm ²
Rated impulse voltage / Pollution severity	kV/-
Gauge to IEC 60947-1 / UL94 Flammability class	
Approvals	
Electronic fixtures	
Component voltage / Component current	V/A
Operating voltage for display, max. / Current	V/mA
Clamped conductors (H05V/H07V)	
solid / stranded	mm ²
flexible / Stranded wire with end ferrules	mm ²
Tightening torque range (clamping screw)	
Stripping length / Blade size	mm/-
Note	

Ordering data

Version	
	Dark beige Wemid
	Dark beige Wemid (red LED)
	Dark beige Wemid (green LED)
Note	

Accessories

Screwable cross-connection	
	2-pole
	3-pole
	4-pole
	10-pole
End plate / partition	
	Dark beige Wemid
End bracket	
	Dark beige Wemid
Screwdriver	
	with „swifty set“ cutting device
	Standard

Marking systems	
	(see assortment in catalogue 7)
	Marking tags
For detailed information on other accessories and applications, refer to the „Accessories“ section	

WDK 2.5 LD + -

2.5 mm²

DC voltage indicator + / -



5.1 x 69 x 63	
10 / 4	
0.13...4	

IEC 60947-7-1		
IEC	UL	CSA
24		
10		
2.5		
	1 / 3	
	A3 / V-0	
24 / 5		
Rated connection		
0.5...4 / 1.5...4		
0.5...4 / 0.5...2.5		
0.4...0.6 Nm (M 2.5)		
10 / 0.6 x 3.5 mm		
Note		

Type	Qty	Order No.
WDK 2.5 LD ROT 1R 24VDC	25	1023600000
WDK 2.5 LD GR 1R 24VDC	25	8023610000
2.5 mm ² conductor with wire end ferrule plus plastic collar only with collar optimised for diameter (order No. 1333100000, 500 pcs)		

Type	current	Qty	Order No.
WQV 2.5/2	32 A	50	1053660000
WQV 2.5/3	32 A	50	1053760000
WQV 2.5/4	32 A	50	1053860000
WQV 2.5/10	32 A	20	1054460000
		Width	
WAP WDK2.5	1.5 mm	20	1059100000
WEW 35/2	8 mm	100	1061200000
		Width	
SWIFTY SET		1	9006060000
SD 0.6x3.5x100		1	9008330000

Marking systems	
	DEK 5/5 / WS 8/5
For detailed information on other accessories and applications, refer to the „Accessories“ section	

WDK 2.5 LD - +

2.5 mm²

DC voltage indicator - / +



5.1 x 69 x 63	
10 / 4	
0.13...4	

IEC 60947-7-1		
IEC	UL	CSA
24		
10		
2.5		
	1 / 3	
	A3 / V-0	
24 / 5		
Rated connection		
0.5...4 / 1.5...4		
0.5...4 / 0.5...2.5		
0.4...0.6 Nm		
10 / 0.6 x 3.5 mm		
Note		

Type	Qty	Order No.
WDK 2.5 LD ROT 1R 24VDC	25	8023630000
WDK 2.5 LD GR 1R 24VDC	25	8010040000
2.5 mm ² conductor with wire end ferrule plus plastic collar only with collar optimised for diameter (order No. 1333100000, 500 pcs)		

Type	current	Qty	Order No.
WQV 2.5/2	32 A	50	1053660000
WQV 2.5/3	32 A	50	1053760000
WQV 2.5/4	32 A	50	1053860000
WQV 2.5/10	32 A	20	1054460000
		Width	
WAP WDK2.5	1.5 mm	20	1059100000
WEW 35/2	8 mm	100	1061200000
		Width	
SWIFTY SET		1	9006060000
SD 0.6x3.5x100		1	9008330000

Marking systems	
	DEK 5/5 / WS 8/5
For detailed information on other accessories and applications, refer to the „Accessories“ section	

Power distribution blocks WPDB

- Space-saving design
- Modular or 3-phase block versions
- Easy to use
- IP20 class of protection
- For TS 35 rail or direct mounting
- High short-circuit protection
- Parallel cross-connection with 5 x 15 mm busbar

WPDB 16/6 3/4

16/6 mm²

WPDB 35-16/16 1-1/6

35/6 mm²

Technical data

Max. current	
80 A	
Dimensions	
Width / Length (incl. mounting) / Height (mm) with TS 35x7.5	
27 x 37 (66) x 47	
Weight	
63 g	
IEC rated 60 947-7-1	
Rated voltage	V
Rated current	A
Rated cross-section in-/output	mm ²
Rated impulse voltage / Pollution severity	2,5 KV / 3
UL94 Flammability Class	V-0
Further technical data	
Short-circuit strength (peak value)	kA
Short-circuit strength > 1 s	kA
Inputs	
No. of connections	
1	
Clampable conductors:	
„e“ solid H07V-U	mm ²
„m“ stranded H07V-R	mm ²
„f“ flexible H07V-K	mm ²
„f“ flexible H07V-K and ferrule acc. to DIN 46 228/1	mm ²
„f“ flexible H07V-K and ferrule with plastic insul. Collar	mm ²
Diameter	mm
Tightening torque	Nm
Clamping screw	M5
Blade size	PZ2
Stripping length	mm
Outputs	
No. of connections	
2	
Clampable conductors:	
„e“ solid H07V-U	mm ²
„m“ stranded H07V-R	mm ²
„f“ flexible H07V-K	mm ²
„f“ flexible H07V-K and ferrule acc. to DIN 46 228/1	mm ²
„f“ flexible H07V-K and ferrule with plastic insul. Collar	mm ²
Diameter	mm
Tightening torque	Nm
Clamping screw	M5
Blade size	PZ2
Stripping length	mm
UL/CSA rated data	
Voltage/current/conductor size	UL
Voltage/current/conductor size	CSA

Inputs		
A	B	C
1		
Clampable conductors:		
„e“ solid H07V-U	mm ²	2,5 ... 16
„m“ stranded H07V-R	mm ²	2,5 ... 16
„f“ flexible H07V-K	mm ²	2,5 ... 16
„f“ flexible H07V-K and ferrule acc. to DIN 46 228/1	mm ²	2,5 ... 16
„f“ flexible H07V-K and ferrule with plastic insul. Collar	mm ²	2,5 ... 16
Diameter	mm	7
Tightening torque	Nm	1,5 ... 3
Clamping screw		M5
Blade size		PZ2
Stripping length	mm	12 ... 18
Outputs		
A	B	C
2	4	
Clampable conductors:		
„e“ solid H07V-U	mm ²	2,5 ... 16
„m“ stranded H07V-R	mm ²	2,5 ... 16
„f“ flexible H07V-K	mm ²	2,5 ... 16
„f“ flexible H07V-K and ferrule acc. to DIN 46 228/1	mm ²	2,5 ... 16
„f“ flexible H07V-K and ferrule with plastic insul. Collar	mm ²	2,5 ... 16
Diameter	mm	7
Tightening torque	Nm	1,5 ... 3
Clamping screw		M5
Blade size		PZ2
Stripping length	mm	9 ... 12
UL/CSA rated data		
Voltage/current/conductor size		UL
Voltage/current/conductor size		CSA

Inputs		
A	B	C
1	1	
Clampable conductors:		
„e“ solid H07V-U	mm ²	10 ... 35
„m“ stranded H07V-R	mm ²	10 ... 35
„f“ flexible H07V-K	mm ²	10 ... 35
„f“ flexible H07V-K and ferrule acc. to DIN 46 228/1	mm ²	10 ... 35
„f“ flexible H07V-K and ferrule with plastic insul. Collar	mm ²	10 ... 35
Diameter	mm	7
Tightening torque	Nm	3,5 ... 5
Clamping screw		M8
Blade size		M4
Stripping length	mm	14 ... 15
Outputs		
A	B	C
6		
Clampable conductors:		
„e“ solid H07V-U	mm ²	2,5 ... 16
„m“ stranded H07V-R	mm ²	2,5 ... 16
„f“ flexible H07V-K	mm ²	2,5 ... 16
„f“ flexible H07V-K and ferrule acc. to DIN 46 228/1	mm ²	2,5 ... 16
„f“ flexible H07V-K and ferrule with plastic insul. Collar	mm ²	2,5 ... 16
Diameter	mm	6,5
Tightening torque	Nm	1,5 ... 3
Clamping screw		M5
Blade size		PZ2
Stripping length	mm	10 ... 12
UL/CSA rated data		
Voltage/current/conductor size		UL
Voltage/current/conductor size		CSA

Ordering Data

Version	dark beige Wemid
----------------	------------------

Type	Qty.	Order No.
WPDB 16/6 3/4	1	1939440000

Type	Qty.	Order No.
WPDB 35-16/16 1-1/6	1	1939450000

Accessories

Screwdrivers	
Crosshead screwdriver, Pozidriv type	
Crosshead screwdriver, Pozidriv type	
7-piece hexagon wrench set	
Labelling systems	
Marking labels for laser printer	

Type	Qty.	Order No.
SDK PZ1	1	9008530000
SDK PZ2	1	9008540000
SK-S 2.0-8.0	1	9008860000
LM MT300 15 x 9 GE	1	1882890000

Type	Qty.	Order No.
SDK PZ2	1	9008540000
SK-S 2.0-8.0	1	9008860000
LM MT300 15 x 9 GE	1	1882890000

WPDB 70/16 1/10

70/16 mm²



175 A
45 x 55 (71) x 42
228 g
690
175
70 / 16
2,5 KV / 3
V-0
22
3
A B C
1
16 ... 70
16 ... 70
16 ... 70
16 ... 70
16 ... 70
12
5
M10
M5
15 ... 16
A B C
10
2,5 ... 16
2,5 ... 16
2,5 ... 16
2,5 ... 16
2,5 ... 16
6
3
M6
M3
10 ... 12

Type	Qty.	Order No.
WPDB 70/16 1/10	1	1939460000

Type	Qty.	Order No.
SK-S 2.0-8.0	1	9008860000
LM MT300 15 x 9 GE	1	1882890000

WPDB 16/6 3/4

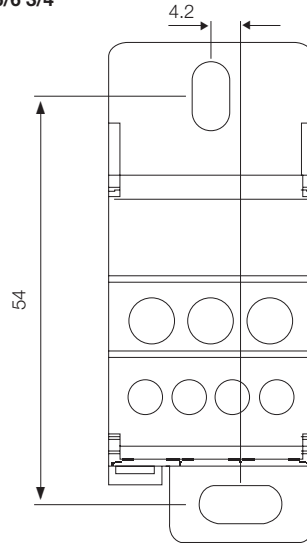

WPDB 35-16/16 1-1/6

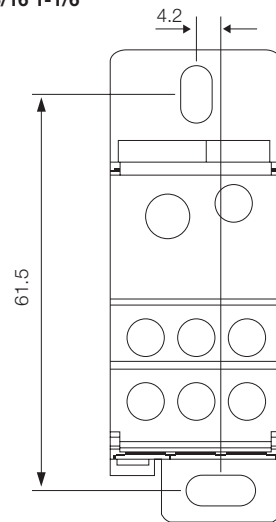

WPDB 70/16 1/10

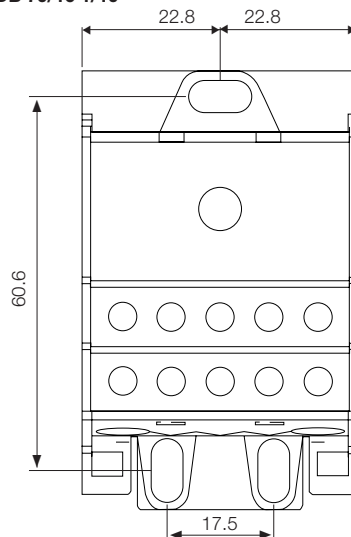

Power distribution blocks WPDB

- Space-saving design
- Modular or 3-phase block versions
- Easy to use
- IP20 class of protection
- For TS 35 rail or direct mounting
- High short-circuit protection
- Parallel cross-connection with 5 x 15 mm busbar

WPDB 120/35-16-10 1/2-5-4 120/35 mm²WPDB 185/35-16-10 1/2-5-4 185/35 mm²

Technical data

Max. current		250 A		400 A
Dimensions				
Width / Length (incl. mounting) / Height (mm) with TS 35x7.5		44,5 x 72 (95,5) x 49		44,5 x 72 (95,5) x 49
Weight		434 g		414 g
IEC rated 60 947-7-1				
Rated voltage	V	690		690
Rated current	A	250		400
Rated cross-section in-/output	mm ²	120 / 35-16-10		185 / 35-16-10
Rated impulse voltage / Pollution severity		2,5 KV / 3		2,5 KV / 3
UL94 Flammability Class		V-0		V-0
Further technical data				
Short-circuit strength (peak value)	kA	51		51
Short-circuit strength > 1 s	kA	24,5		24,5
Inputs		A	B	C
No. of connections		1		1
Clampable conductors:				
„e“ solid H07V-U	mm ²	35 ... 120		95 ... 185
„m“ stranded H07V-R	mm ²	35 ... 120		95 ... 185
„f“ flexible H07V-K	mm ²	35 ... 120		95 ... 185
„f“ flexible H07V-K and ferrule acc. to DIN 46 228/1	mm ²	35 ... 120		95 ... 185
„f“ flexible H07V-K and ferrule with plastic insul. Collar	mm ²	35 ... 120		95 ... 185
Diameter	mm	15		19
Tightening torque	Nm	19		25
Clamping screw		M14		M16
Blade size		M6		M8
Stripping length	mm	27 ... 29		27 ... 29
Outputs		A	B	C
No. of connections		2	5	4
Clampable conductors:				
„e“ solid H07V-U	mm ²	2,5 ... 35	2,5 ... 16	2,5 ... 10
„m“ stranded H07V-R	mm ²	2,5 ... 35	2,5 ... 16	2,5 ... 10
„f“ flexible H07V-K	mm ²	2,5 ... 35	2,5 ... 16	2,5 ... 10
„f“ flexible H07V-K and ferrule acc. to DIN 46 228/1	mm ²	2,5 ... 35	2,5 ... 16	2,5 ... 10
„f“ flexible H07V-K and ferrule with plastic insul. Collar	mm ²	2,5 ... 25	2,5 ... 16	2,5 ... 10
Diameter	mm	12	8	7
Tightening torque	Nm	3,5	2	2
Clamping screw		M8	M6	M6
Blade size		SD 1,0 x 5,5 x 150	SD 0,8 x 4,5 x 125	SD 0,8 x 4,5 x 125
Stripping length	mm	10 ... 12	10 ... 12	10 ... 12
UL/CSA rated data				
Voltage/current/conductor size	UL			
Voltage/current/conductor size	CSA			

Ordering Data

Version	Type	Qty.	Order No.
dark beige Wemid	WPDB 120/35-16-10 1/2-5-4	1	1939470000
	WPDB 185/35-16-10 1/2-5-4	1	1939480000

Accessories

Screwdrivers	Type	Qty.	Order No.
Crosshead screwdriver, Pozidriv type	SD 1,0 x 5,5 x 150	1	9008350000
Crosshead screwdriver, Pozidriv type	SD 0,8 x 4,5 x 125	1	9009020000
7-piece hexagon wrench set	SK-S 2,0-8,0	1	9008860000
Labelling systems			
Marking labels for laser printer	LM MT300 15 x 9 GE	1	1882890000

WPDB 3 x 70/16 1/6

70/16 mm²



175 A
80 x 54,5 (71,5) x 42,5
386 g
690
175
70 / 16
2,5 KV / 3
V-0

A	B	C
3 x 1		
16 ... 70		
16 ... 70		
16 ... 70		
16 ... 70		
16 ... 70		
12		
5		
M10		
M5		
15 ... 16		
A	B	C
3 x 6		
2,5 ... 16		
2,5 ... 16		
2,5 ... 16		
2,5 ... 16		
2,5 ... 16		
6		
3		
M6		
M3		
10 ... 12		

Type	Qty.	Order No.
WPDB 3 x 70/16 1/6	1	1939490000

Type	Qty.	Order No.
SK-S 2.0-8.0	1	9008860000
LM MT300 15 x 9 GE	1	1882890000

WPDB 120/35-16-10 1/2-5-4

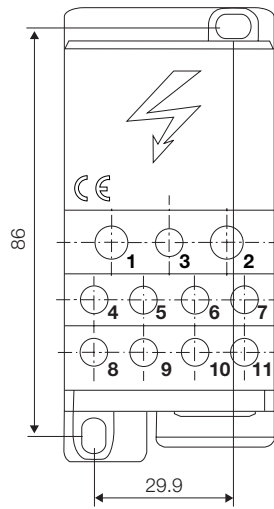

WPDB 185/35-16-10 1/2-5-4

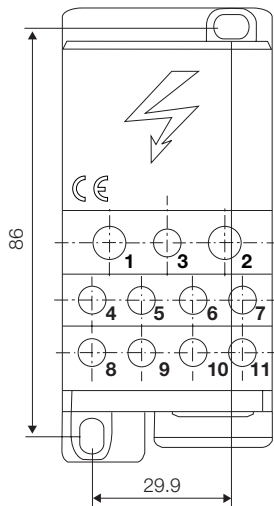

WPDB 3 x 70/16 1/6

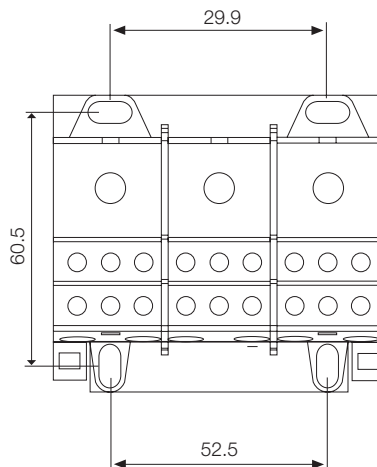

Power distribution blocks WPDB

- Space-saving design
- Modular or 3-phase block versions
- Easy to use
- IP20 class of protection
- For TS 35 rail or direct mounting
- High short-circuit protection
- Parallel cross-connection with 5 x 15 mm busbar

WPDB 70/16 1/6

70/16 mm²

With distribution for busbars
(parallel connection) Cu 16 x 5 mm max.



WPDB 35/16/6/N 1/2/5/11

35/16/6/N mm²

Three-phase power-supply block
with neutral-conductor busbar



Technical data

Max. current	
Dimensions	
Width / Length (incl. mounting) / Height (mm) with TS 35x7.5	
Weight	
IEC rated 60 947-7-1	
Rated voltage	V
Rated current	A
Rated cross-section in-/output	mm ²
Rated impulse voltage / Pollution severity	
UL94 Flammability Class	
Further technical data	
Short-circuit strength (peak value)	kA
Short-circuit strength > 1 s	kA
Inputs	
No. of connections	
Clampable conductors:	
„e“ solid H07V-U	mm ²
„m“ stranded H07V-R	mm ²
„f“ flexible H07V-K	mm ²
„f“ flexible H07V-K and ferrule acc. to DIN 46 228/1	mm ²
„f“ flexible H07V-K and ferrule with plastic insul. Collar	mm ²
Diameter	mm
Tightening torque	Nm
Clamping screw	
Blade size	
Stripping length	mm
Outputs	
No. of connections	
Clampable conductors:	
„e“ solid H07V-U	mm ²
„m“ stranded H07V-R	mm ²
„f“ flexible H07V-K	mm ²
„f“ flexible H07V-K and ferrule acc. to DIN 46 228/1	mm ²
„f“ flexible H07V-K and ferrule with plastic insul. Collar	mm ²
Diameter	mm
Tightening torque	Nm
Clamping screw	
Blade size	
Stripping length	mm
UL/CSA rated data	
Voltage/current/conductor size	UL
Voltage/current/conductor size	CSA

Max. current	160 A
Dimensions	
Width / Length (incl. mounting) / Height (mm) with TS 35x7.5	35 x 72 (92) x 49
Weight	238 g
IEC rated 60 947-7-1	
Rated voltage	690
Rated current	160
Rated cross-section in-/output	70 / 16
Rated impulse voltage / Pollution severity	2,5 KV / 3
UL94 Flammability Class	V-0
Further technical data	
Short-circuit strength (peak value)	30
Short-circuit strength > 1 s	11,8
Inputs	
No. of connections	A B C
Clampable conductors:	
„e“ solid H07V-U	10 ... 70
„m“ stranded H07V-R	10 ... 70
„f“ flexible H07V-K	10 ... 70
„f“ flexible H07V-K and ferrule acc. to DIN 46 228/1	10 ... 70
„f“ flexible H07V-K and ferrule with plastic insul. Collar	10 ... 70
Diameter	13
Tightening torque	4
Clamping screw	M10
Blade size	M5
Stripping length	19 ... 23
Outputs	
No. of connections	A busbar C
Clampable conductors:	
„e“ solid H07V-U	2,5 ... 16
„m“ stranded H07V-R	2,5 ... 16
„f“ flexible H07V-K	2,5 ... 16
„f“ flexible H07V-K and ferrule acc. to DIN 46 228/1	2,5 ... 16
„f“ flexible H07V-K and ferrule with plastic insul. Collar	2,5 ... 16
Diameter	6
Tightening torque	2
Clamping screw	M5
Blade size	PZ2
Stripping length	10 ... 12
UL/CSA rated data	
Voltage/current/conductor size	
Voltage/current/conductor size	

Max. current	125 A
Dimensions	
Width / Length (incl. mounting) / Height (mm) with TS 35x7.5	98 x 56,5 (74,5) x 45
Weight	314 g
IEC rated 60 947-7-1	
Rated voltage	690
Rated current	125
Rated cross-section in-/output	35 / 16
Rated impulse voltage / Pollution severity	2,5 KV / 3
UL94 Flammability Class	V-0
Further technical data	
Short-circuit strength (peak value)	30
Short-circuit strength > 1 s	11,8
Inputs	
No. of connections	A B C
Clampable conductors:	
„e“ solid H07V-U	6 ... 35
„m“ stranded H07V-R	6 ... 35
„f“ flexible H07V-K	6 ... 35
„f“ flexible H07V-K and ferrule acc. to DIN 46 228/1	6 ... 35
„f“ flexible H07V-K and ferrule with plastic insul. Collar	6 ... 25
Diameter	9
Tightening torque	1,5
Clamping screw	M5
Blade size	PZ2
Stripping length	12 ... 18
Outputs	
No. of connections	A B C
Clampable conductors:	
„e“ solid H07V-U	6 ... 35
„m“ stranded H07V-R	6 ... 35
„f“ flexible H07V-K	6 ... 35
„f“ flexible H07V-K and ferrule acc. to DIN 46 228/1	6 ... 35
„f“ flexible H07V-K and ferrule with plastic insul. Collar	6 ... 25
Diameter	9
Tightening torque	1,5
Clamping screw	M5
Blade size	PZ2
Stripping length	12 ... 18
UL/CSA rated data	
Voltage/current/conductor size	
Voltage/current/conductor size	

Ordering Data

Version	
	dark beige Wemid

Type	Qty.	Order No.
WPDB 70/16 1/6	1	1939500000

Type	Qty.	Order No.
WPDB 35/16/6/N 1/2/5/11	1	1939510000

Accessories

Screwdrivers	
	Crosshead screwdriver, Pozidriv type
	Crosshead screwdriver, Pozidriv type
	7-piece hexagon wrench set
Labelling systems	
	Marking labels for laser printer

Type	Qty.	Order No.
SDK PZ2	1	9008540000
SK-S 2.0-8.0	1	9008860000
LM MT300 15 x 9 GE	1	1882890000

Type	Qty.	Order No.
SDK PZ1	1	9008530000
SDK PZ2	1	9008540000
LM MT300 15 x 9 GE	1	1882890000

WPDB 70/16 1/6

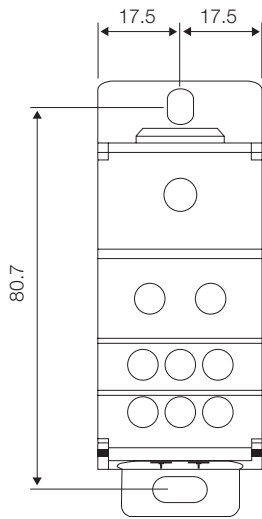

WPDB 35/16/6/N 1/2/5/11

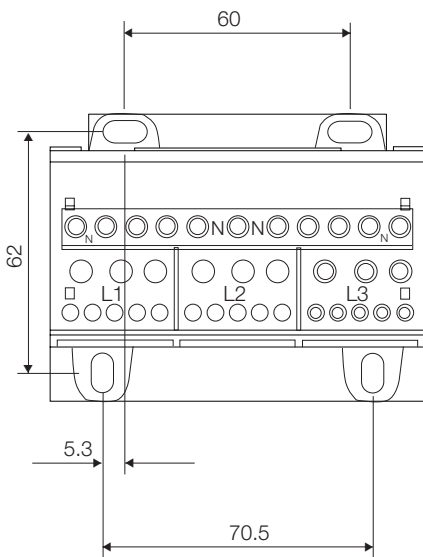

Assembly instructions

WPDB 120/35-16-10 1/2-5-4 and
WPDB 185/35-16-10 1/2-5-4

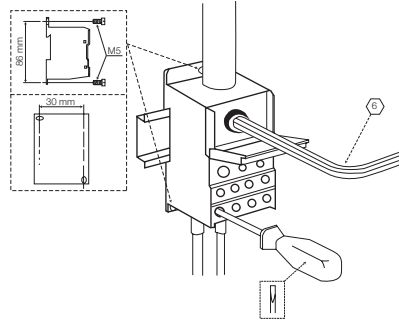

WPDB 70/16 1/6

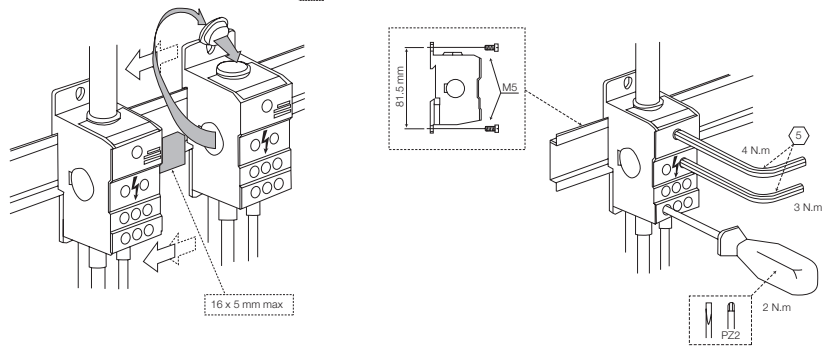

WPDB 35-16/16 1-1/6

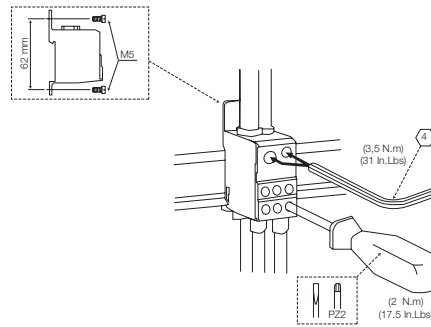

WPDB 35/16/6/N 1/2/5/11

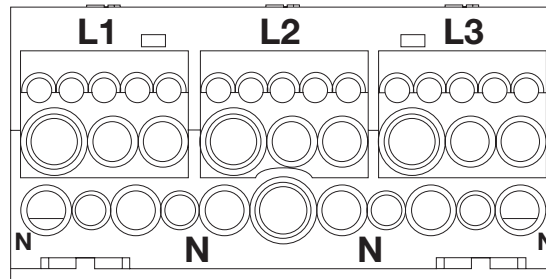

WPDB 3x70/16 1/6

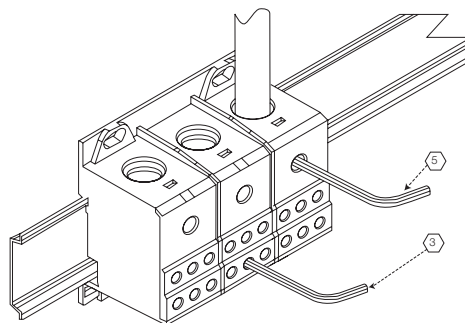

Mini terminals TS 15

In hazardous area applications, the installation instructions and the rated data specifications for accessories given in the technical appendix must be followed.

Width/Length/height with TS15x7.5	mm
max. current / max. cond. cross-section	A/mm ²
Max. clamping range	mm ²

Technical data

Rated data	
Rated voltage	V
Rated current	A
Rated cross-section	mm ²
Rated impulse voltage / Pollution severity	kV/-
Gauge to IEC 60947-1 / UL94 Flammability class	
Approvals	
Clamped conductors (H05V/H07V)	
solid / stranded	mm ²
flexible / Stranded wire with end ferrules	mm ²
Tightening torque range (clamping screw)	
Stripping length / Blade size	mm/-
2 conductors with same cross-section (H05V/H07V)	
solid / stranded	mm ²
flexible / Stranded wire with end ferrules	mm ²
Note	

Ordering data

Version	
	beige (PA)
	Blue (PA)
	green/yellow (PA)
Note	

Accessories

Screwable cross-connection	
	2-pole
	3-pole
	4-pole
	10-pole
End plate / partition	
	Dark beige Wemid
	Blue Wemid
	Dark beige Wemid
	Blue Wemid
Insulation plate	
	Insulation plate
End bracket	
	Dark beige Wemid
Testing / Checking	
	Test plug
	Socket

Marking systems	
	(see assortment in catalogue 7)
	Marking tags
For detailed information on other accessories and applications, refer to the „Accessories“ section	

AKZ 1.5

1.5 mm²

Feed-through terminal

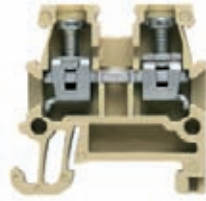

5.1 x 24.8 x 25	
24 / 2.5	
0.21...2.5	

IEC 60947-7-1 Ex e ll  II 2 G D

IEC	UL	CSA	EN 60079-7
250	150	300	176
17.5	15	10	10
1.5	AWG 22...14	AWG 24...16	1.5
4 / 3			
A1 / V2			

   SIRA 02ATEX3001 U

Rated connection	
0.5...2.5 / 1.5...1.5	
0.5...1.5 / 0.5...1.5	
0.4...0.6 Nm (M 2.5)	
7 / 3.0 x 0.5 mm	
0.5...1	
0.5...1 / 0.5...0.75	

Type	Qty	Order No.
AKZ 1.5	100	0340460000
AKZ 1.5 BL	100	0340480000
Note		
AKZ 1.5 order Nos 0340460000 and 0340480000 made from PA with V2 flammability rating to UL 94		

Type	current	Qty	Order No.
Q 2 AKZ1.5	24 A	50	0368200000
Q 3 AKZ1.5		50	0368300000
Q 4 AKZ1.5		50	0368400000
Q 10 AKZ1.5		20	0368500000
		Width	
AP AKZ1.5	1.5 mm	50	0340560000
AP AKZ1.5 BL	1.5 mm	50	0340580000
EW 15	10 mm	50	0382860000
PS 2.3 RT	5.4 mm	20	0180400000
STB 8.5/D4/2.3/M2.5 AKZ		50	0215700000

Marking systems	
	DEK 5/5

AKZ 2.5

2.5 mm²

Feed-through terminal

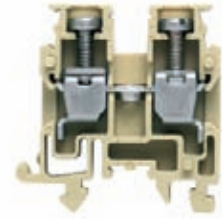

5.1 x 25.5 x 26.5	
32 / 4	
0.13...4	

IEC 60947-7-1 Ex e ll  II 2 G D

IEC	UL	CSA	EN 60079-7
250	300	300	176
24	10	10	15
2.5	AWG 22...12	AWG 26...10	2.5
4 / 3			
A3 / V2			

   SIRA 02ATEX3001 U

Rated connection	
0.5...4 / 1.5...2.5	
0.5...2.5 / 0.5...2.5	
0.4...0.6 Nm (M 2.5)	
7 / 3.0 x 0.5 mm	
0.5...1.5	
0.5...1.5 / 0.5...1.5	

Type	Qty	Order No.
AKZ 2.5	100	0697160000
AKZ 2.5 BL	100	0697180000
Note		
AKZ 2.5 order Nos 0697160000 and 0697180000 made from PA with V2 flammability rating to UL 94		

Type	current	Qty	Order No.
Q 2 AKZ1.5	24 A	50	0368200000
Q 3 AKZ1.5		50	0368300000
Q 4 AKZ1.5		50	0368400000
Q 10 AKZ1.5		20	0368500000
		Width	
AP AKZ2.5	2.5 mm	50	0697360000
AP AKZ2.5 BL	2.5 mm	50	0697380000
TW AKZ2.5	0.5 mm	20	0318560000
TW AKZ2.5 BL	0.5 mm	20	0318580000
EW 15	10 mm	50	0382860000
PS 2.3 RT	5.4 mm	20	0180400000
STB 8.5/D4/2.3/M2.5 AKZ		50	0215700000

Marking systems	
	DEK 5/5

AKZ 4

4 mm²



6.1 x 27 x 30.5
41 / 6
0.13...6

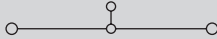

IEC 60947-7-1 Ex e II Ex II 2 G D

IEC	UL	CSA	EN 60079-7
400	300	300	275
32	27	10	21
4	AWG 22...12	AWG 24...12	4
6 / 3			
A3 / V2			

SIRA 02ATEX3001 U

Rated connection

0.5...6 / 1.5...4
0.5...4 / 0.5...2.5
0.6...0.8 Nm (M 3)
8 / 0.6 x 3.5 mm

0.5...1.5

0.5...1.5 / 0.5...1.5

Type	Qty	Order No.
AKZ 4 WEMID	100	9537110000
AKZ 4 WEMID BL	100	1038680000

AKZ 4 order no. 9537110000 and 1038680000 made of PA with flammability class acc. to UL 94/V-2

Type	current	Qty	Order No.
Q 2 AKZ4	32 A	50	0336400000
Q 3 AKZ4	32 A	50	0336500000
Q 4 AKZ4	32 A	50	0336600000
Q 10 AKZ4	32 A	20	0368600000
Width			
AP AKZ4	1.5 mm	20	0294460000
AP AKZ4 BL	1.5 mm	20	0294480000
TW AKZ4	0.5 mm	50	0348260000
TW AKZ4 BL	0.5 mm	50	0348280000
TSCH 4 AKZ4	6 mm	100	0363360000
EW 15	10 mm	50	0382860000
PS 2.3 RT	5.4 mm	20	0180400000
STB 8.5/D4/2.3/M2.5 AKZ		50	0215700000

DEK 5/6

AKE 2.5

2.5 mm²



5.1 x 28 x 28
/ 4
0.13...4



IEC 60947-7-2 Ex e II Ex II 2 G D

IEC	UL	CSA	EN 60079-7
2.5	AWG 22...12	AWG 26...12	2.5
/ 3			
A3 / V2			

SIRA 02ATEX3001 U

Rated connection

0.5...4 / 1.5...2.5
0.5...2.5 / 0.5...2.5
0.4...0.6 Nm (M 2.5)
7 / 3.0 x 0.5 mm

Type	Qty	Order No.
AKE 2.5	100	1303360000

Type	Qty	Order No.

DEK 5/5

AKE 4

4 mm²



7 x 32 x 34.5
/ 4
0.13...4

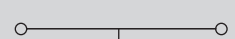

IEC 60947-7-2 Ex e II Ex II 2 G D

IEC	UL	CSA	EN 60079-7
4	AWG 22...12	AWG 26...12	4
/ 3			
A3 / V2			

SIRA 02ATEX3001 U

Rated connection

0.5...4 / 1.5...4
0.5...4 / 0.5...2.5
0.5...1.0 Nm (M 3)
9 / 0.6 x 3.5 mm

Type	Qty	Order No.
AKE 4	100	0380260000

Type	Qty	Order No.

DEK 5/6,5

Mini terminals TS 15

In hazardous area applications, the installation instructions and the rated data specifications for accessories given in the technical appendix must be followed.

Width/Length/height with TS15x7.5	mm ²
max. current / max. cond. cross-section	A/mm ²
Max. clamping range	mm ²

Technical data

Rated data	
Rated voltage	V
Rated current	A
Rated cross-section	mm ²
Rated impulse voltage / Pollution severity	kV/-
Gauge to IEC 60947-1 / UL94 Flammability class	
Approvals	

Clamped conductors (H05V/H07V)

solid / stranded	mm ²
flexible / Stranded wire with end ferrules	mm ²
Tightening torque range (clamping screw)	
Stripping length / Blade size	mm/-
2 conductors with same cross-section (H05V/H07V)	
solid / stranded	mm ²
flexible / Stranded wire with end ferrules	mm ²

Note

Ordering data

Version	
	Dark beige Wemid (PA)
	Blue Wemid (PA)

Note

Accessories

Pluggable cross-connection	
	2-pole
	3-pole
	4-pole
	10-pole

End plate / partition

Dark beige Wemid

End bracket

Dark beige Wemid

Marking systems (see assortment in catalogue 7)
Marking tags

For detailed information on other accessories and applications, refer to the „Accessories“ section

WDU 1.5/R 3.5

1.5 mm²

Feed-through terminal (V0)

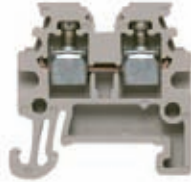

3.5 x 24.5 x 25

17.5 / 1.5

0.13...1.5

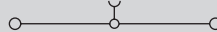

IEC 60947-7-1

Ex e ll II 2 G D

IEC	UL	CSA	EN 60079-7
400	300	300	275
17.5	10	10	14
1.5	AWG 26...14	AWG 26...16	1.5
4 / 3			
A1 / V-0			

IEC 60947-7-1 Ex e ll II 2 G D KEMA 99ATEX6545 U

Rated connection

0.5...1.5 / 1.5...1.5
0.5...1.5 / 0.5...1.5
0.3 Nm (M 2)
7 / 0.4 x 2.5 mm

0.5...0.75
0.5...0.75 / 0.5...0.5

PZ 6/5 recommended as crimping tool for 1.5 mm² with wire-end ferrule

Type	Qty	Order No.
WDU 1.5/R3.5	100	1753280000
WDU 1.5/R3.5 BL	100	1754170000

Type	current	Qty	Order No.
ZQV 1.5N/R3.5/2 GE	17.5 A	50	1754210000
ZQV 1.5N/R3.5/3 GE	17.5 A	50	1754220000
ZQV 1.5N/R3.5/4 GE	17.5 A	20	1754230000
ZQV 1.5N/R3.5/10 GE	17.5 A	20	1754290000

Width	
WAP WDU 1.5/R3.5	1.5 mm 20 1754190000
EW 15	10 mm 50 0382860000

DEK 5/3,5

WDK 1.5/R3.5

1.5 mm²

Double feed-through terminal (V0)

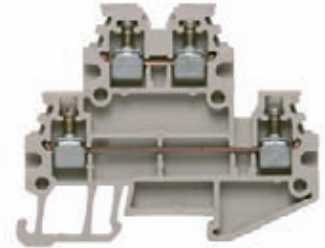

3.5 x 46.5 x 38.5

16 / 1.5

0.13...1.5

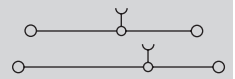

IEC 60947-7-1

Ex e ll II 2 G D

IEC	UL	CSA	EN 60079-7
400	300	300	275
16	10	10	15
1.5	AWG 26...14	AWG 26...16	1.5
4 / 3			
A1 / V-0			

IEC 60947-7-1 Ex e ll II 2 G D KEMA 99ATEX6545 U

Rated connection

0.5...1.5 / 1.5...1.5
0.5...1.5 / 0.5...1.5
0.3 Nm (M 2)
7 / 0.4 x 2.5 mm

0.5...0.75
0.5...0.75 / 0.5...0.5

PZ 6/5 recommended as crimping tool for 1.5 mm² with wire-end ferrule

Type	Qty	Order No.
WDK 1.5/R3.5	100	1753290000
WDK 1.5/R3.5 BL	100	1754180000

Type	current	Qty	Order No.
ZQV 1.5N/R3.5/2 GE	17.5 A	50	1754210000
ZQV 1.5N/R3.5/3 GE	17.5 A	50	1754220000
ZQV 1.5N/R3.5/4 GE	17.5 A	20	1754230000
ZQV 1.5N/R3.5/10 GE	17.5 A	20	1754290000

Width	
WAP WDK 1.5/R3.5	1.5 mm 20 1754200000
EW 15	10 mm 50 0382860000

DEK 5/3,5

WPE 1.5/R3.5

1.5 mm²

PE terminal (V0)



In hazardous area applications, the installation instructions and the rated data specifications for accessories given in the technical appendix must be followed.

Width/Length/height with TS15x7.5	mm ²
max. current / max. cond. cross-section	A/mm ²
Max. clamping range	mm ²

3.5 x 24.5 x 25
/ 1.5
0.13...1.5

Technical data

Rated data	
Rated cross-section	mm ²
Rated voltage to adjacent terminal	V
Rated impulse withstand voltage to adjacent terminal	kV
Short-time withstand current	
Pollution severity	
Gauge to IEC 60947-1 / UL94 Flammability class	
Approvals	
Clamped conductors (H05V/H07V)	
solid / stranded	mm ²
flexible / Stranded wire with end ferrules	mm ²
Tightening torque range (clamping screw)	
Tightening torque range (fixing screw)	
Stripping length / Blade size	mm/-
Note	

IEC 60947-7-2

IEC	UL	CSA
1.5	AWG 26...	AWG 18
400		
6		
	180 A (1,5 mm ²)	
	3	
	A1 / V-0	

®

Rated connection	
0.5...1.5 / 1.5...1.5	
0.5...1.5 / 0.5...1.5/ 0.5...1.5	
0.3 Nm (M 2)	
7 / 0.4 x 2.5 mm	

PZ 6/5 recommended as crimping tool for 1.5 mm² with wire-end ferrule

Ordering data

Version
green/yellow Wemid (PA)
Note

Type	Qty	Order No.
WPE 1.5/R3.5	100	1798460000

Accessories

End plate / partition	
	Dark beige Wemid
End bracket	
	Dark beige Wemid

Type	Width	Qty	Order No.
WAP WDU1.5/R3.5	1.5 mm	20	1754190000
EW 15	10 mm	50	0382860000

Marking systems (see assortment in catalogue 7)
Marking tags

DEK 5/3,5

For detailed information on other accessories and applications, refer to the „Accessories“ section

Stud terminals

Power transmission

Weidmüller's extensive range of stud terminals offers secure connections for all applications which entail a transmission of energy. The connection range extends from 10 mm² to 300 mm² and is available for TS 35 or TS 32 DIN Rail Mounting.

The conductors are applied to the threaded studs by means of crimped cable lugs, and then securely connected by tightening the hex nut. Stud terminals can be used with threaded studs M5 to M16, depending on the conductor cross-section.

Maximum safety is guaranteed by low through resistance and self-extinguishing material in flammability class V-0 (UL94).

All stud terminals are tested according to international railway standards (EN 50343, EN 50155, NF F61-017, NF16-101; RIA 20) and comply with these requirements.

Handling

To connect the conductors, cable lugs are crimped to the ends of the conductors. The cable lugs are placed on the stud between the washer on the terminal carrier and toothed washer. The backs of the cable lugs lie against each other. The hex nuts are tightened to press the lugs of the cable lugs against each other for secure contact.

In addition, a third conductor can be positioned from the opposite connection direction.

Series WF / WFF

- for voltage ranges up to 1000 V
- also suitable for up to 2300 V and 520 A when using specialepoxy resin partition plates

Single stud terminals WF

- 4 conductors can be securely connected without any problems
- 3 conductors even without restricting the rating data

Twin-stud terminals WFF

- integrated hinged head

Series ST 4000

- for voltage ranges up to 4000 V and currents up to 415 A
- for extreme demands, particularly in railway applications

Accessories

We also offer extensive accessories for our stud terminals, with detailed descriptions on the following pages.

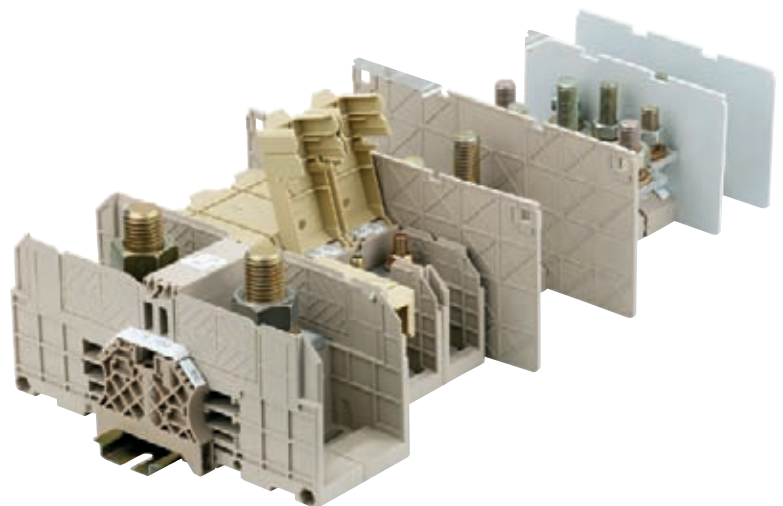

Product overview

Thread size	M5	M6	M8	M10	M12	M16
Single-stud terminals – WF	•	•	•	•	•	
Two-stud terminals – WF 2 BZ		•	•	•		
Two-stud terminals – WFF		•	•	•	•	•
Two-stud terminals – ST 4000 (up to 4000 V)			•	•	•	

Stud connection

- Stud size M5 to M16
- Conductor with cable lug to DIN 46234 up to 240 mm² to DIN 46235 up to 300 mm²
- 3 cable lugs possible per stud, even 4 cable lugs with the WF-Series



Cross connections

- Faster electrical distribution for clear time savings
- Can be used for all stud terminals
- Available in 2, 3 and 4-poles version
- Electrical distribution possible between different sizes (from WF6 to WF8 and to WF10)

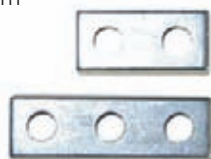

Easy to use

- Cable lugs placed on washer on stud
- Washer and toothed washer placed on top
- Steel nut tightened to create contact between cable lugs and – if applicable – busbar

Wemid clamp support

- Non-tracking, CTI 600
- Thermally stable up to 120 °C
- Self-extinguishing V0 flammability class to UL94
- No hazardous substances
- Low smoke and fume.
- Complies with the requirements of DIN 5510 part 2, railway standard NFF 16-101 and BS 6853

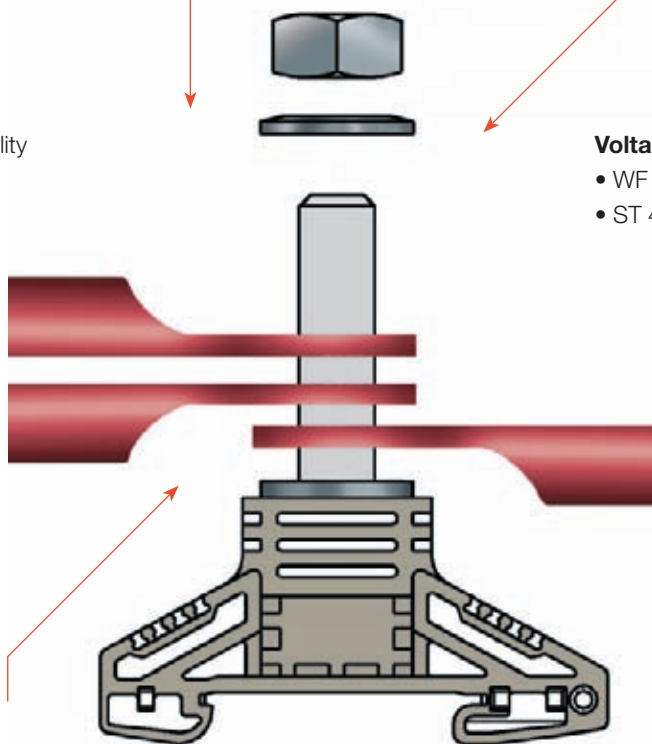

Voltage range

- WF / WFF up to 2.300 V
- ST 4000 up to 4.000 V

Reliable contact

- Maintenance free, no need to retighten the nuts
- Toothed washer for vibration-proof, high strength contact
- Cable lugs contact directly or via a highly conductive busbar



“Toothed” washer with protective coating.

Safe to use

- Shock protection
- in WF with partition plates and transparent cover strips
 - in WFF with locking cover for each connection
 - in ST 4000 with screw-on polycarbonate cover

Standards

- Fulfil requirements for standard terminals and specific railway standards
- EN 60 947-7-1
 - EN 50124-1
 - DIN EN 61373
 - RIA 20
 - EN 50343
 - NF F 61-017

Stud terminals - Accessories

Series WF and WFF

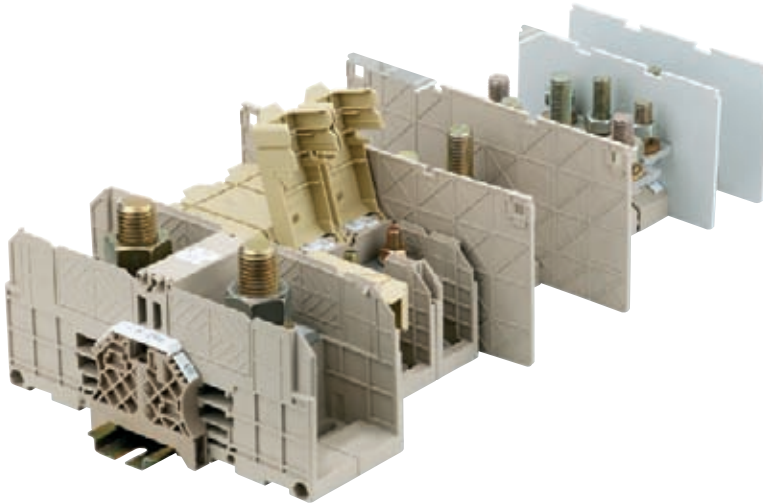

Electrical distribution



Electrical distribution can be realised between neighbouring stud terminals easily with 2 and 3 poles crossconnections. Cross-connections are also available for different thread sizes from M6 to M8 or M10. In the WFF twostud terminals, firstly the partition plates have to be removed between the clamped supports. The thin web of material means they can be broken out easily to fit.

Shock protection



The two-stud terminals in the WF-Series offer with an integrated hinged cover a high degree of finger safety. When closed, the cover locks onto the terminal and protects the contact from accidental contact.

Shock protection / partition plates

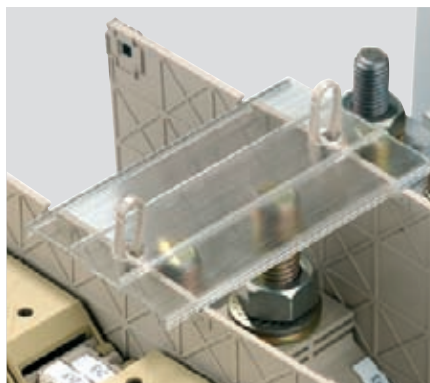

Shock protection in the WF-Series is provided by partition plates WTW and transparent cover strips ADP. The cover strips are locked into the guides of the partition plates and held with clips to prevent them slipping to the side. Partition plates ensure compliance with the rated voltage:

- Voltage range up to 1000 V with partition plate WTW WF
- Voltage range up to 2300 V for WF with epoxy partition plate WTW WF 2300

Connection

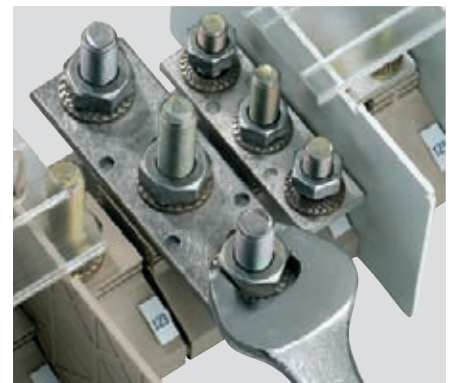

Couldn't be easier: the cable lugs are placed on the stud with the washer and toothed washer on top. A normal openended spanner can be used to tighten the hex screw and complete installation.

Series ST 4000

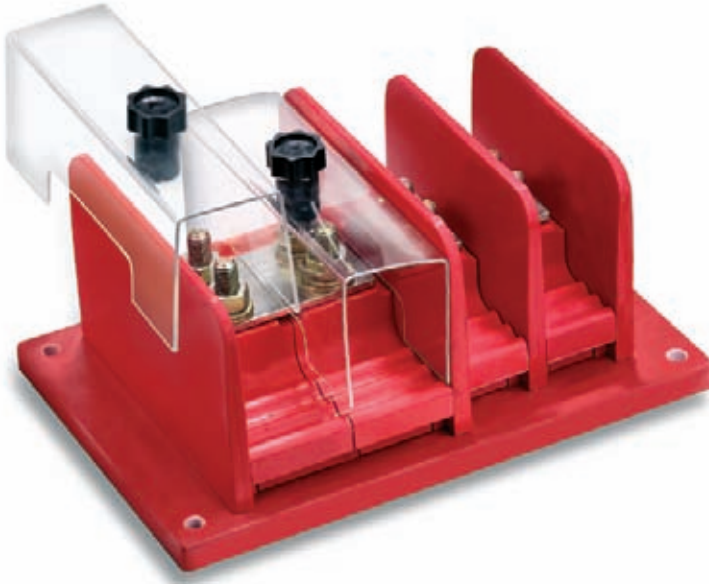

Shock protection



Stud terminals in the ST 4000 series offer an ideal cover for every version. The polycarbonate cover is placed between the partition plates and fastened to the stud with the plastic-coated fixing nut.

Fixing nuts are available to fit every stud size.

Potential distribution



When two neighbouring ST 4000 terminals have the same current, cross-connectors are fitted instead of the busbar.

The pairs of holes in the cross-connection are rated exactly to the spacing of ST 4000.

Here the partition plate has to be replaced by the connecting piece ST 4000/S C130 or ST 4000/L C160.

Cross-connections are available as 2, 3 or 4-poles.

Connection



Couldn't be easier: the cable lugs are placed on the stud with the washer and toothed washer on top. Tighten the steel hexagonal nut to ensure good contact between cable lug and busbar.

The same principle applies when two cable lugs contact on one stud or slotted hole cable lugs are used.

Slotted hole cable lugs can also be placed over both studs.

Single-stud terminals

WF series

In hazardous area applications, the installation instructions and the rated data specifications for accessories given in the technical appendix must be followed.

Width/Length/height with TS35x7.5	mm
max. current / Flexible, max.	A
Max. clamping range	mm ²

Technical data

Rated data with Wemid partition wall

Rated voltage	V
Rated current	A
Rated cross-section	mm ²
Rated impulse voltage / Pollution severity	kV/-
Gauge to IEC 60947-1 / UL94 Flammability class	
Approvals	

Clamped cable lugs

Cable lug to DIN 46234	
2 cable lugs to DIN 46234	
Cable lug to DIN 46234	
2 cable lugs to DIN 46234	
Tightening torque range	

Note

Ordering data

Version	Dark beige Wemid
Note	

Accessories

Cross-connection	2-pole	
	3-pole	
Partition wall	Dark beige Wemid	
	Beige epoxy resin	
End bracket	Dark beige Wemid	
Hood, transparent	Hood, transparent	
Holder for shrouding cover, transparent	Holder for shrouding cover, transparent	

Marking systems	(see assortment in catalogue 7)
	Marking tags

For detailed information on other accessories and applications, refer to the „Accessories“ section

WF 5

16 mm²

Screw thread M5



13 x 67 x 54
76 / 16
0.1...16

IEC	UL	CSA
1000	1000	1000
76	85	85
16	AWG 10...4	AWG 10...4
	8 / 3	
	/ V-0	
0.1...16 mm ²		
0.1...16 mm ²		
6...10 mm ²		
6...10 mm ²		
2.0...4.0 Nm		

Type	Qty	Order No.
WF 5	25	1790130000

Type	current	Qty	Order No.
WQL 2 WF5	76 A	5	1812710000
WQL 3 WF5	76 A	5	1812740000
	Width		
WTW WF6-WF12	2.5 mm	20	1781240000
WTW WF6 2300	2 mm	20	1781230000
	Width		
WEW 35/2	8 mm	100	1061200000
	Width		
ADP WF6/WF8		1	1780930000
	Width		
HA ADP WF6/WF10		10	1781050000

WS 12/5	
With WTW...2300 made from epoxy resin, rated current is 2300 V according to prelim. EN 50124-1	

WF 6

35 mm²

Screw thread M6



17.8 x 67 x 56
125 / 35
2.5...35

IEC	UL	CSA
1000	1000	1000
125	115	150
35	AWG 14...2	AWG 14...2
	8 / 3	
	/ V-0	
2.5...35 mm ²		
2.5...35 mm ²		
6...35 mm ²		
6...25 mm ²		
3.0...6.0 Nm		

Type	Qty	Order No.
WF 6	25	1780850000

Type	current	Qty	Order No.
WQL 2 WF6	125 A	5	1780970000
WQL 3 WF6	125 A	5	1780980000
	Width		
WTW WF6	2 mm	20	1781220000
WTW WF6 2300	2 mm	20	1781230000
	Width		
WEW 35/2	8 mm	100	1061200000
	Width		
ADP WF6/WF8		1	1780930000
	Width		
HA ADP WF6/WF10		10	1781050000

WS 10/6	
With WTW...2300 made from epoxy resin, rated current is 2300 V according to prelim. EN 50124-1	

WF 8

50 mm²

Screw thread M8



22.8 x 67 x 65
150 / 50
2.5...50

IEC	UL	CSA
1000	1000	1000
150	150	200
50	AWG 14...1/0	AWG 14...1/0
8 / 3		
/ V-0		



2.5...50 mm²
2.5...50 mm²
6...35 mm²
6...35 mm²
6.0...12 Nm

The WQL 2, for WF 6 on WF 8, is available under order no. 1808980000.

Type	Qty	Order No.
WF 8	25	1780860000

Type	current	Qty	Order No.
WQL 2 WF8	150 A	5	1780990000
WQL 3 WF8	150 A	5	1781000000
Width			
WTW WF8	2 mm	20	1780900000
WTW WF8 2300	2 mm	20	1780910000
WEW 35/2	8 mm	100	1061200000
ADP WF6/WF8		1	1780930000
HA ADP WF6/WF10		10	1781050000

WS 10/6

With WTW...2300 made from epoxy resin, rated current is 2300 V according to prelim. EN 50124-1

WF 10

120 mm²

Screw thread M10



33.8 x 67 x 74
269 / 120
6...120

IEC	UL	CSA
1000	1000	1000
269	255	320
120	AWG 10...kcmil250	AWG 10...kcmil250
8 / 3		
/ V-0		



6...120 mm²
6...120 mm²
10...95 mm²
10...95 mm²
10...20 Nm

The WQL 2, for WF 6 on WF 10, is available under order no. 180662000.

Type	Qty	Order No.
WF 10	20	1780870000

Type	current	Qty	Order No.
WQL 2 WF10	269 A	5	1781010000
WQL 3 WF10	269 A	5	1781020000
Width			
WTW WF10/WF12	2 mm	20	1780890000
WTW WF10/WF12 2300	2 mm	20	1780920000
WEW 35/2	8 mm	100	1061200000
ADP WF10/WF12		1	1780940000
HA ADP WF6/WF10		10	1781050000

WS 10/6

With WTW...2300 made from epoxy resin, rated current is 2300 V according to prelim. EN 50124-1

WF 12

120 mm²

Screw thread M12



33.8 x 67 x 72
269 / 120
6...120

IEC	UL	CSA
1000	1000	1000
269	255	320
120	AWG 10...kcmil250	AWG 10...kcmil250
8 / 3		
/ V-0		



6...120 mm²
6...120 mm²
10...95 mm²
10...95 mm²
14...31 Nm

Type	Qty	Order No.
WF 12	20	1780880000

Type	current	Qty	Order No.
WQL 2 WF12	269 A	5	1781030000
WQL 3 WF12	269 A	5	1781040000
Width			
WTW WF10/WF12	2 mm	20	1780890000
WTW WF10/WF12 2300	2 mm	20	1780920000
WEW 35/2	8 mm	100	1061200000
ADP WF10/WF12		1	1780940000
HA ADP WF6/WF10		10	1781050000

WS 10/6

With WTW...2300 made from epoxy resin, rated current is 2300 V according to prelim. EN 50124-1

Twin stud terminals

WF 2BZ

In hazardous area applications, the installation instructions and the rated data specifications for accessories given in the technical appendix must be followed.

Width/Length/height with TS35x7.5	mm
max. current / Flexible, max.	A/mm ²
Max. clamping range	mm ²

Technical data

Rated data with Wemid partition wall

Rated voltage	V
Rated current	A
Rated cross-section	mm ²
Rated impulse voltage / Pollution severity	kV/-
Gauge to IEC 60947-1 / UL94 Flammability class	
Approvals	

Clamped cable lugs

Cable lug to DIN 46234
2 cable lugs to DIN 46234
Cable lug to DIN 46234
2 cable lugs to DIN 46234
Tightening torque range

Note

Ordering data

Version	Dark beige Wemid
Note	

Accessories

Cross-connection	2-pole
	3-pole
Partition wall	Dark beige Wemid
	Beige epoxy resin
End bracket	Dark beige Wemid
Hood, transparent	Hood, transparent
Holder for shrouding cover, transparent	Holder for shrouding cover, transparent

Marking systems (see assortment in catalogue 7)
Marking tags

For detailed information on other accessories and applications, refer to the „Accessories“ section

WF 6/2BZ

35 mm²

Screw thread M6



17.8 x 67 x 56

125 / 35

2.5...35



	IEC	UL	CSA
	1000	1000	1000
	125	115	150
	35	AWG 14...2	AWG 14...2
		8 / 3	
		/ V-0	
Approvals			
	2.5...35 mm ²		
	2.5...35 mm ²		
	6...25 mm ²		
	6...25 mm ²		
	3.0...6.0 Nm		

Type	Qty	Order No.
WF 6/2BZ	25	1789770000

Type	current	Qty	Order No.
WQL 2 WF6	125 A	5	1780970000
WQL 3 WF6	125 A	5	1780980000
	Width		
WTW WF10/WF12	2 mm	20	1780890000
WTW WF6 2300	2 mm	20	1781230000
	Width		
WEW 35/2	8 mm	100	1061200000
	Width		
ADP WF10/WF12		1	1780940000
	Width		
HA ADP WF6/WF10		10	1781050000

WS 12/5

With WTW...2300 made from epoxy resin, rated current is 2300 V, according to prelim. EN 50124-1

WF 8/2BZ

50 mm²

Screw thread M8



22.8 x 67 x 65

150 / 50

2.5...50

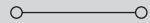

	IEC	UL	CSA
	1000	1000	1000
	150	150	200
	50	AWG 14...1/0	AWG 14...1/0
		8 / 3	
		/ V-0	
Approvals			
	2.5...50 mm ²		
	2.5...50 mm ²		
	6...35 mm ²		
	6...35 mm ²		
	6.0...12 Nm		

Type	Qty	Order No.
WF 8/2BZ	25	1789780000

Type	current	Qty	Order No.
WQL 2 WF8	150 A	5	1780990000
WQL 3 WF8	150 A	5	1781000000
	Width		
WTW WF10/WF12	2 mm	20	1780890000
WTW WF8 2300	2 mm	20	1780910000
	Width		
WEW 35/2	8 mm	100	1061200000
	Width		
ADP WF10/WF12		1	1780940000
	Width		
HA ADP WF6/WF10		10	1781050000

WS 12/5

With WTW...2300 made from epoxy resin, rated current is 2300 V, according to prelim. EN 50124-1

WF 10/2BZ

120 mm²

Screw thread M10

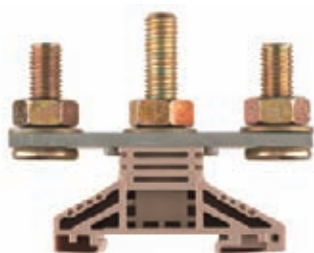

33.8 x 67 x 74

269 / 120

6...120

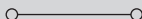

IEC	UL	CSA
1000	1000	1000
269	230	320
120	AWG 10..kmi250	AWG 10..kmi250
	8 / 3	
	/ V-0	



6...120 mm²

6...120 mm²

10...95 mm²

10...95 mm²

10...20 Nm

Type	Qty	Order No.
WF 10/2BZ	20	1789790000

Type	current	Qty	Order No.
WQL 2 WF10	269 A	5	1781010000
WQL 3 WF10	269 A	5	1781020000
Width			
WTW WF10/WF12	2 mm	20	1780890000
WTW WF10/WF12 2300	2 mm	20	1780920000
WEW 35/2	8 mm	100	1061200000
ADP WF10/WF12		1	1780940000
HA ADP WF6/WF10		10	1781050000

WS 12/5

With WTW...2300 made from epoxy resin, rated current is 1500 V up to 70 mm², according to prelim. EN 50124-1

Twin stud terminals

WFF series

In hazardous area applications, the installation instructions and the rated data specifications for accessories given in the technical appendix must be followed.

Width/Length/height with TS35x7.5	mm
max. current / Flexible, max.	A/mm ²
Max. clamping range	mm ²

Technical data

Rated data with Wemid partition wall

Rated voltage	V
Rated current	A
Rated cross-section	mm ²
Rated impulse voltage / Pollution severity	kV/-
Gauge to IEC 60947-1 / UL94 Flammability class	
Approvals	

Clamped cable lugs

Cable lug to DIN 46234 / 2 cable lugs to DIN 46234
Cable lug to DIN 46234 / 2 cable lugs to DIN 46234
Tightening torque range

Note

Ordering data

Version	
	Dark beige Wemid
	Dark beige Wemid
	Blue Wemid

Note

Accessories

Cross-connection	
	2-pole
	3-pole

Partition wall	
	Dark beige Wemid

End bracket	
	Dark beige Wemid

Hood	
	Hood, dark beige Wemid

Warning triangle for power supply terminals

Marking systems	(see assortment in catalogue 7)
	Marking tags

For detailed information on other accessories and applications, refer to the „Accessories“ section

Technical drawing

WFF 35

35 mm²

Screw thread M6



27 x 107 x 54.5

150 / 50

2.5...50

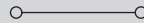

Ex e ll II 2 G D

IEC	UL	CSA	EN 60079-7
1000	1000	600	1100
125	115	130	109
35	AWG 14...2	AWG 14...2	35
8 / 3			
/ V-0			

KEMA 98ATEX1684 U

2.5...50 mm² / 2.5...35 mm²6...25 mm² / 6...25 mm²

3.0...6.0 Nm



Type	Qty	Order No.
WFF 35	10	1028300000
WFF 35/AH	5	1029300000
WFF 35 BL	10	1028380000

Type	current	Qty	Order No.
WQL 2 WFF35	150 A	5	1064900000
WQL 3 WFF35	150 A	5	1065400000

Width			
WTW WFF35	2 mm	10	1067100000

WEW 35/1	12 mm	50	1059000000
----------	-------	----	------------

WAH 35		20	1064460000
--------	--	----	------------

WD 1 25 K KARTE A 6 ST		5	1563900000
------------------------	--	---	------------

WS 12/6,5			
-----------	--	--	--

WAH 35 in blue, order no. 1064480000

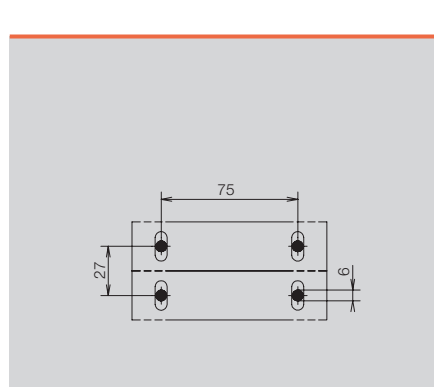

WFF 70

70 mm²

Screw thread M8



32 x 132 x 64

232 / 95

2.5...95

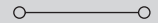

Ex e ll II 2 G D

IEC	UL	CSA	EN 60079-7
1000	1000	600	1100
192	175	170	167
70	AWG 14...2/0	AWG 14...2/0	70
8 / 3			
/ V-0			

KEMA 98ATEX1684 U

2.5...95 mm² / 2.5...70 mm²16...70 mm² / 16...70 mm²

6.0...12 Nm



Type	Qty	Order No.
WFF 70	10	1028400000
WFF 70/AH	5	1029400000
WFF 70 BL	10	1028480000

Type	current	Qty	Order No.
WQL 2 WFF70	232 A	5	1065000000
WQL 3 WFF70	232 A	5	1065500000

Width			
WTW WFF70	2 mm	10	1067200000

WEW 35/1	12 mm	50	1059000000
----------	-------	----	------------

WAH 70 BE		20	1064560000
-----------	--	----	------------

WD 1 25 K KARTE A 6 ST		5	1563900000
------------------------	--	---	------------

WS 12/6,5			
-----------	--	--	--

WAH 70 in blue, order no. 1064580000

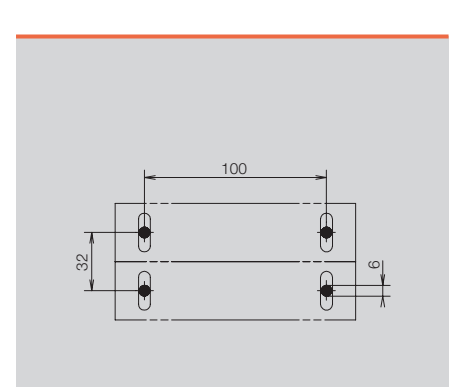

WFF 120

120 mm²

Screw thread M10



42 x 132 x 73
309 / 150
6...150

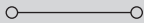

Ex e ll II 2 G D

IEC	UL	CSA	EN 60079-7
1000	1000	600	1100
269	310	310	234
120	AWG10.kam1250	AWG10.kam1250	120
8 / 3			
/ V-0			

KEMA 98ATEX1684 U

6...150 mm² / 6...120 mm²
16...150 mm² / 16...120 mm²
10...20 Nm

WFF 185

185 mm²

Screw thread M12



55 x 163 x 79
415 / 240
10...240



Ex e ll II 2 G D

IEC	UL	CSA	EN 60079-7
1000	1000	600	1100
353	380	360	307
185	AWG8.kam1500	AWG8.kam1500	185
8 / 3			
/ V-0			

KEMA 98ATEX1684 U

10...240 mm² / 10...185 mm²
25...240 mm² / 25...185 mm²
14...31 Nm

WFF 300

300 mm²

Screw thread M16



55 x 163 x 86
520 / 240
25...240

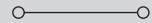

Ex e ll II 2 G D

IEC	UL	CSA	EN 60079-7
1000	1000	600	1100
520	500	510	452
300	AWG6.kam1600	AWG6.kam1600	300
8 / 3			
/ V-0			

KEMA 98ATEX1684 U

25...240 mm² / 25...240 mm²
50...300 mm² / 50...240 mm²
25...60 Nm

Type	Qty	Order No.
WFF 120	5	1028500000
WFF 120/AH	4	1029500000
WFF 120 BL	5	1028580000

Type	Qty	Order No.
WFF 185	4	1028600000
WFF 185/AH	2	1029600000
WFF 185 BL	4	1028680000

Type	Qty	Order No.
WFF 300	4	1028700000
WFF 300/AH	2	1029700000
WFF 300 BL	4	1028780000

Type	current	Qty	Order No.
WQL 2 WFF120	269 A	5	1065100000
WQL 3 WFF120	269 A	5	1065600000
Width			
WTW WFF120	2 mm	10	1067300000
WEW 35/1	12 mm	50	1059000000
WAH 120		20	1064660000
WD 1 25 K KARTE A 6 ST		5	1563900000

Type	current	Qty	Order No.
WQL 2 WFF185	353 A	5	1065200000
WQL 3 WFF185	353 A	5	1065700000
Width			
WTW WFF185/300	2 mm	10	1067400000
WEW 35/1	12 mm	50	1059000000
WAH 185/300 BE		10	1064760000
WD 1 25 K KARTE A 6 ST		5	1563900000

Type	current	Qty	Order No.
WQL 2 WFF300	520 A	5	1065300000
WQL 3 WFF300	520 A	5	1065800000
Width			
WTW WFF185/300	2 mm	10	1067400000
WEW 35/1	12 mm	50	1059000000
WAH 185/300 BE		10	1064760000
WD 1 25 K KARTE A 6 ST		5	1563900000

WS 12/6,5
WAH 120 in blue, order no. 1064650000

WS 12/6,5
WAH 185/300 in blue, order no. 1064780000

WS 12/6,5
WAH 185/300 in blue, order no. 1064780000

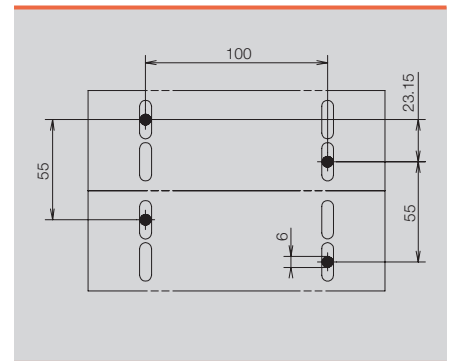
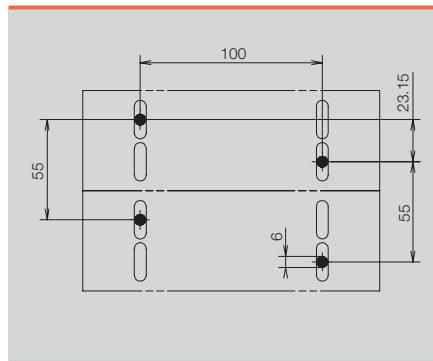
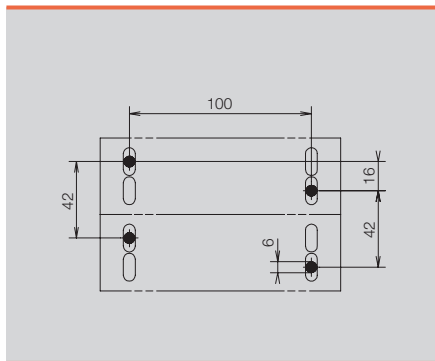

Twin stud terminals

ST 4000 (up to 4 kV)

In hazardous area applications, the installation instructions and the rated data specifications for accessories given in the technical appendix must be followed.

Width/Length/height with TS35x7.5	mm
max. current / Flexible, max.	A/mm ²
Max. clamping range	mm ²

Technical data

Rated data with Wemid partition wall

Rated voltage	V
Rated current	A
Rated cross-section	mm ²
Rated impulse voltage / Pollution severity	kV/-
Gauge to IEC 60947-1 / UL94 Flammability class	
Approvals	

Clamped cable lugs

Cable lug to DIN 46234
2 cable lugs to DIN 46234
Cable lug to DIN 46234
2 cable lugs to DIN 46234
Tightening torque range

Note

Ordering data

Version	red
	With internal thread
Note	

Accessories

Cross-connection	
	2-pole
	3-pole
	4-pole
Busbar	
	M8 / 4 mm thick
	M10 / 4 mm thick
	M10 / 6 mm thick
	M12 / 4 mm thick
	M12 / 6 mm thick
Connecting piece	
	130 mm length
	160 mm length
Partition wall	
	150 mm length
	180 mm length
End partition	
	150 mm length
	180 mm length
Touch-safe protection	
	150 mm length
	180 mm length

(see assortment in catalogue 7)

For detailed information on other accessories and applications, refer to the „Accessories“ section

ST 4000/S M8

120 mm²

Screw thread M8



40 x 150 x 84

269 / 120

1.5...120



IEC	UL	CSA
4000		
269		
120		
	30 / 3	
	/ V-0	
1.5 - 120 mm ²		
16...70 mm ²		
6.0...12 Nm		
Rated voltage when using cable lugs to DIN 46234		

Type	Qty	Order No.
ST 4000/S M8	25	1809110000
ST 4000/S M8 F	25	1809120000
Weidmüller can prepare drawings for a ST 4000 application to customer specification.		

Type	current	Qty	Order No.
ST 4000/S J2 M8	269 A	100	1809310000
ST 4000/S J3 M8	269 A	50	1809320000
ST 4000/S J4 M8	269 A	25	1809330000
Width			
ST 4000/S CB M8/4		100	1809250000
Width			
ST 4000/S C130		50	1809230000
Width			
ST 4000/S P150	10 mm	50	1809190000
Width			
ST 4000/S E150	10 mm	50	1809210000
Width			
ST 4000/S S150		20	1809470000

ST 4000/S M10

120 mm²

Screw thread M10



40 x 150 x 84

269 / 120

4...120



IEC	UL	CSA
4000		
269		
120		
	30 / 3	
	/ V-0	
4 - 120 mm ²		
10...20 Nm		
Rated voltage when using cable lugs to DIN 46234		

Type	Qty	Order No.
ST 4000/S M10	25	1809130000
ST 4000/S M10 F	25	1809140000
Weidmüller can prepare drawings for a ST 4000 application to customer specification.		

Type	current	Qty	Order No.
ST 4000/S J2 M10		100	1809340000
ST 4000/S J3 M10		50	1809350000
ST 4000/S J4 M10		25	1809360000
Width			
ST 4000/S CB M10/4		100	1809260000
ST 4000/S CB M10/6		100	1809270000
Width			
ST 4000/S C130		50	1809230000
Width			
ST 4000/S P150	10 mm	50	1809190000
Width			
ST 4000/S E150	10 mm	50	1809210000
Width			
ST 4000/S S150		20	1809470000

ST 4000/L M10

150 mm²

Screw thread M10



55 x 180 x 90

309 / 150

10...150



IEC	UL	CSA
4000		
309		
150		
	30 / 3	
	/ V-0	
10 - 150 mm ²		
25 - 150 mm ²		
10...20 Nm		
Rated voltage when using cable lugs to DIN 46234		

Type	Qty	Order No.
ST 4000/L M10	15	1809150000
ST 4000/L M10 F	15	1809160000
Weidmüller can prepare drawings for a ST 4000 application to customer specification.		

Type	current	Qty	Order No.
ST 4000/L J2 M10	309 A	50	1809370000
ST 4000/L J3 M10	309 A	50	1809380000
ST 4000/L J4 M10	309 A	25	1809390000
	Width		
ST 4000/L CB M10/4		100	1809280000
ST 4000/L C160		50	1809240000
ST 4000/L P180	10 mm	50	1809200000
ST 4000/L E180	10 mm	50	1809220000
ST 4000/L S180		1	1809480000

ST 4000/L M12

240 mm²

Screw thread M12



55 x 180 x 90

415 / 240

10...240



IEC	UL	CSA
4000		
415		
240		
	30 / 3	
	/ V-0	
10...240 mm ²		
25...240 mm ²		
14...31 Nm		
Rated voltage when using cable lugs to DIN 46234		

Type	Qty	Order No.
ST 4000/L M12	15	1809170000
ST 4000/L M12 F	15	1809180000
Weidmüller can prepare drawings for a ST 4000 application to customer specification.		

Type	current	Qty	Order No.
ST 4000/L J2 M12		50	1809400000
ST 4000/L J3 M12		50	1809410000
ST 4000/L J4 M12		25	1809420000
	Width		
ST 4000/L CB M12/4		100	1809290000
ST 4000/L CB M12/6		100	1809300000
ST 4000/L C160		50	1809240000
ST 4000/L P180	10 mm	50	1809200000
ST 4000/L E180	10 mm	50	1809220000
ST 4000/L S180		1	1809480000

Extra functions

Weidmüller offers the user of W-Series terminals a comprehensive range of accessories, providing optimum solutions to every conceivable task – even outside the range of standard functions.

All Weidmüller accessories are built to the same quality standards as the terminals themselves.

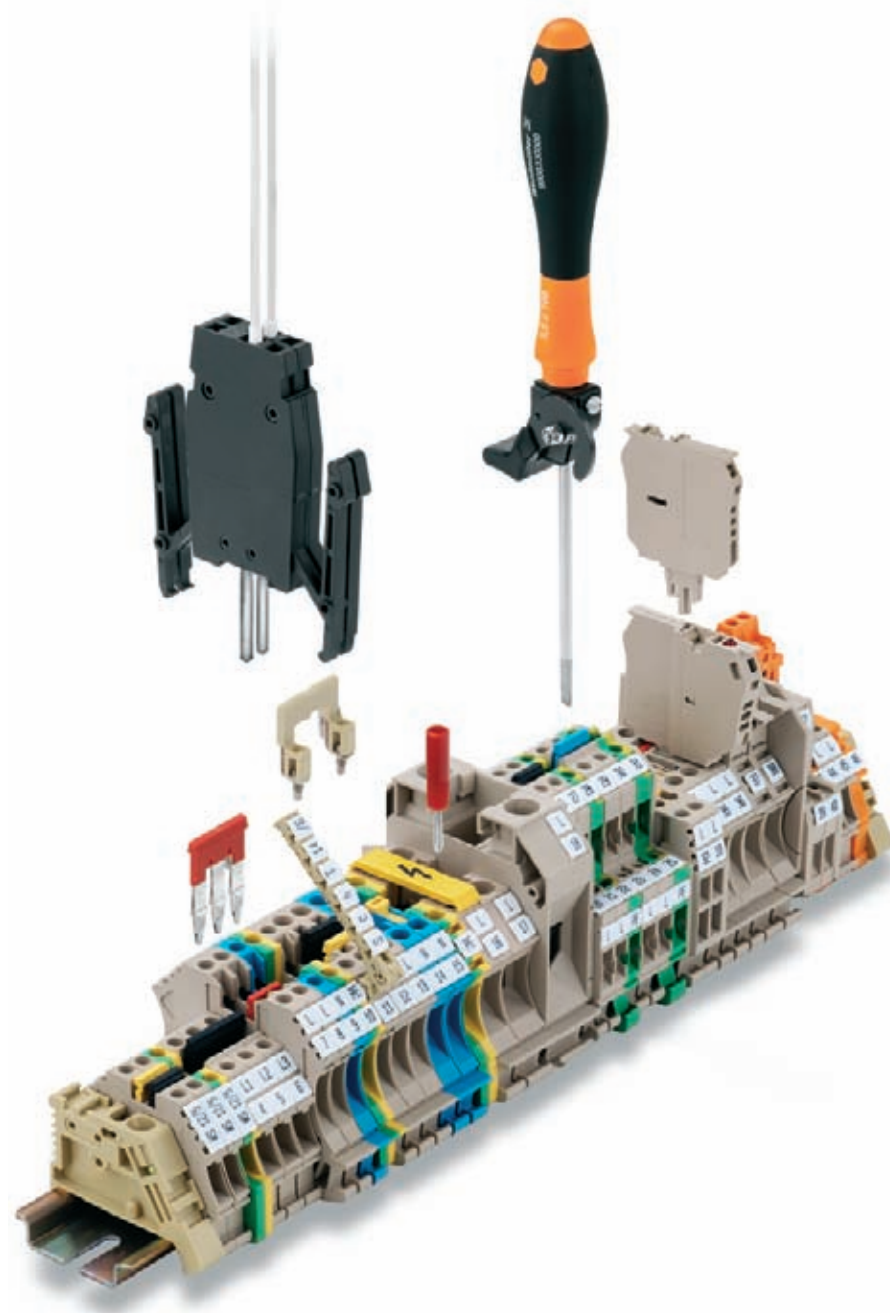

Visual separation – Side covers

Page E.104



To guarantee “finger-safe” use of terminals, the open sides are covered with end plates and partition plates to prevent any contact with conducting parts. End plates and partition plates also come in different colours so that they can be used for visual separation of different circuits.

Labelling

Page E.126



Weidmüller’s labelling systems in **chapter G** are used to label screw terminals. Individual clamping points, terminal groups and conductors can be marked. The cover (WAD) can also be used for labelling mains supply points (see **page E.116**).

Fastening

Page G.29

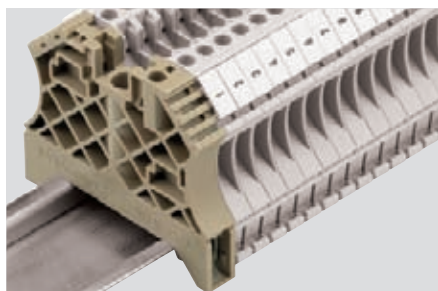

An end bracket is fitted on the terminal rail to the right and left of the terminals to ensure that they sit firmly in position. The marking surface of the end bracket can also be used for group marking. Details of the wide range of Weidmüller end brackets and mounting rails are given in **Chapter F**.

Power supply

Page E.110

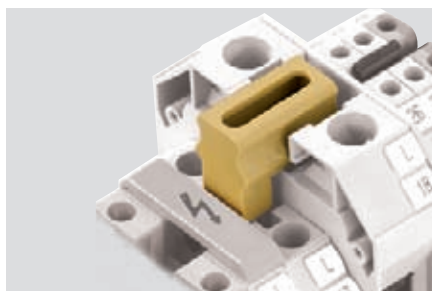

For the W-Series, power is supplied via standard terminals in conjunction with a special cross-connection, which directly connects terminals for larger and smaller cross-sections (the picture shows WDU 35 on WDU 4).

It is possible to form a link to screw-in cross-connections of smaller cross-sections (WQV 2.5/4/6). This extends current distribution to any number of other terminals of the smaller cross-section.

Current distribution

Page E.114



A screw-in and a plug-in cross-connection system is available for Weidmüller screw terminals. The plug-in **cross-connection (ZQV)** for screw terminals is unique. It enables considerable reductions in assembly times. The plug-in cross-connections can be used for nearly all W-Series terminals in the cross-section ranges 2.5 and 4 mm².

Connecting

Chapter G



Conductors are connected into Weidmüller terminals using standard screwdrivers, as shown in **chapter F**, **page G.74**.

Testing

Page E.123

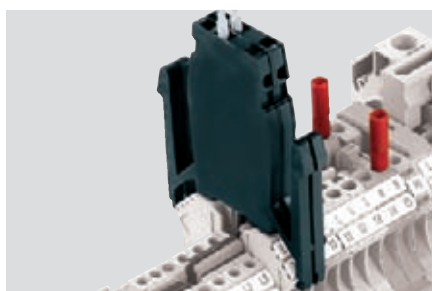

The slot-in test adapter (WTA) is used as both a single unit and a test adapter strip for measurement in control cabinets. The test adapter is ideal for convenient, rational testing of assembled terminals. However, tests with socket and test plug are also always possible (page E.113).

Specific functions / colour variations

Page E.127



Further helpful accessories are available for terminals using screw clamp technology, such as:

- Pluggable fuse holder (SIHA 1 and SIHA 2)
- Screen plug (LS), short-cir. plug (WDS)
- Extension connectors (WZAD)
- PEN bridges
- Accessories for disconnect test-terminals
- Terminals in various colours
- Pre-fitted **terminal blocks**

Accessories - Optical separation / lateral cover

End plates

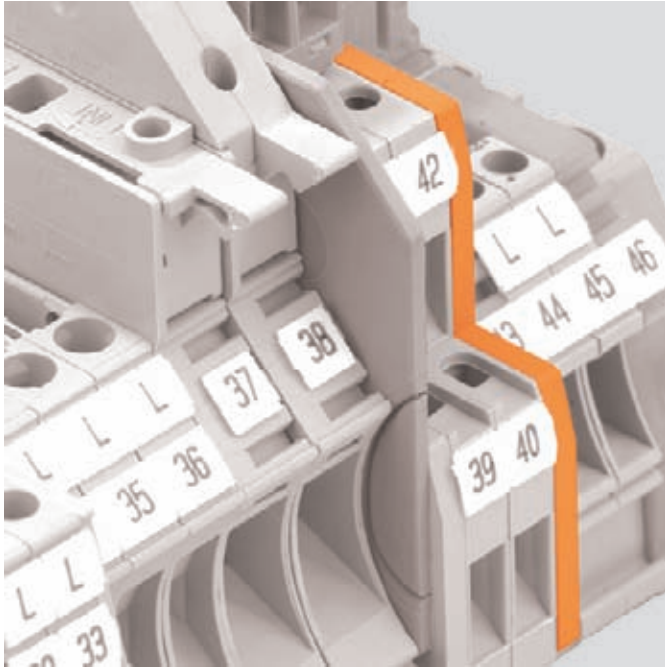

Touch protection

With only a few exceptions, the last terminal in a terminal strip must be closed off with a WAP/AP-type end plate. End plates must also be used within a terminal strip when it makes use of terminals of different sizes. This ensures the touch-safe requirement is met for live voltage components. The terminals are touch-safe (DIN VDE 0106-100).

Optical separation

Coloured end plates are very frequently used for distinguishing the circuits visually.

Ensuring the operating voltage

End plates can also be used to maintain the required clearance and creepage distances, in order to guarantee the rated voltage for the application. They can be used when cross-connections are used side-by-side.

Contour matching The overall dimensions of the end plates match the external dimensions of the associated terminal.

Mounting

The end plate's snap-in pegs allow it to be simply fitted on to the corresponding terminal. The corresponding indentations in the terminal are used to ensure that position follows the identical contours. All colour variations are classified according to UL 94 V-0.

Ordering data

Type	Colour	Qty	Order No.	For terminal:
WAP 2.5-10	dark beige	50	1050000000	WDU 1.5/ZZ
WAP 2.5-10 BL	blue/light blue	50	1050080000	WDU 1.5/ZZ BL
WAP 2.5-10 BR	brown	50	1050070000	WDU 10
WAP 2.5-10 GE	yellow	50	1050020000	WDU 10 BL
WAP 2.5-10 GE	yellow	50	2068740000	WDU 10 SL
WAP 2.5-10 GN	green	50	1072200000	WDU 10 SL/EN
WAP 2.5-10 GR	grey	50	1050050000	WDU 10 SL/EN SW
WAP 2.5-10 GR 7042	grey	50	1879290000	WDU 2.5
WAP 2.5-10 OR	Orange	50	1050060000	WDU 2.5 BL
WAP 2.5-10 RT	red	50	1050040000	WDU 2.5 F 2X2.8
WAP 2.5-10 SW	black	50	1050010000	WDU 2.5 FF 2*2.8
WAP 2.5-10 VI	violet	50	1072210000	WDU 2.5/1.5/ZR
WAP 2.5-10 WS	white	50	1050090000	WDU 2.5/1.5/ZR BL
				WDU 2.5/TC TYP B
				WDU 2.5/TC TYP E
				WDU 2.5/TC TYP J
				WDU 2.5/TC TYP K
				WDU 2.5/TC TYP N
				WDU 2.5/TC TYP SR
				WDU 2.5/TC TYP T
				WDU 4
				WDU 4 BL
				WDU 4 SL
				WDU 4 SL/EN
				WDU 4 SL/EN SW
				WDU 6
				WDU 6 BL
				WDU 6 SL
				WDU 6 SL/EN
				WDU 6 SL/EN SW
				WDUL 4 100R/0.75W POTI
				WDUL 4 10K/0.75W POTI
				WDUL 4 10R/0.75W POTI
				WDUL 4 1K/0.75W POTI
				WDUL 4 500K/0.1W POTI
				WDUL 4 500R/0.75W POTI
				WDUL 4 50K/0.75W POTI
				WDUL 4 5K/0.75W
				WDUL 4 OHNE POTI
				WNT 10 10X3
				WNT 10 10X3 BE
				WNT 2.5 10X3
				WNT 2.5 10X3 BE
				WNT 4 10X3
				WNT 4 10X3 BE
				WNT 6 10X3
				WNT 6 10X3 BE
				WPE 1.5/ZZ
				WPE 10
				WPE 2.5

Ordering data

Type	Colour	Qty	Order No.	For terminal:
WAP 16+35 WTW 2.5-10	dark beige	20	105010000	WDK 2.5 / 800V
WAP 16+35 WTW 2.5-10 BL	blue/light blue	20	1050180000	WDK 2.5 FF
WAP 16+35 WTW 2.5-10 GR	grey	20	1879140000	WDU 1.5/ZZ
WAP 16+35 WTW 2.5-10 OR	Orange	20	1050160000	WDU 1.5/ZZ BL
				WDU 10
				WDU 10 BL
				WDU 10 SL
				WDU 10 SL/EN
				WDU 10 SL/EN SW
				WDU 10/ZR
				WDU 10/ZR BL
				WDU 16/ZA
				WDU 16/ZA BL
				WDU 2.5
				WDU 2.5 BL
				WDU 2.5 F 2X2,8
				WDU 2.5 FF 2*2.8
				WDU 2.5/1.5/ZR
				WDU 2.5/1.5/ZR BL
				WDU 2.5/TC TYP B
				WDU 2.5/TC TYP E
				WDU 2.5/TC TYP J
				WDU 2.5/TC TYP K
				WDU 2.5/TC TYP N
				WDU 2.5/TC TYP SR
				WDU 2.5/TC TYP T
				WDU 2.5N/600 UL
				WDU 35/IK/ZA
				WDU 4
				WDU 4 BL
				WDU 4 SL
				WDU 4 SL/EN
				WDU 4 SL/EN SW
				WDU 6
				WDU 6 BL
				WDU 6 SL
				WDU 6 SL/EN
				WDU 6 SL/EN SW
				WDUL 4 100R/0,75W POTI
				WDUL 4 10K/0,75W POTI
				WDUL 4 10R/0,75W POTI
				WDUL 4 1K/0,75W POTI
				WDUL 4 500K/0,1W POTI
				WDUL 4 500R/0,75W POTI
				WDUL 4 50K/0,75W POTI
				WDUL 4 5K/0,75W
				WDUL 4 OHNE POTI
				WPE 1.5/ZZ
				WPE 10
				WSI 6
Width				
WAP WDK2.5	dark beige	20	1059100000	WDK 2.5
WAP WDK2.5 RS-SET	dark beige	10	1819170000	WDK 2.5 DU-PE
WAP WDK2.5 BL	blue/light blue	20	1059180000	WDK 2.5 F
WAP WDK2.5 GN	green	20	1059140000	WDK 2.5 F BL
				WDK 2.5 FF
				WDK 2.5 FV
				WDK 2.5 LD GR 1R 24VDC
				WDK 2.5 LD GR 1R 24VDC
				WDK 2.5 LD ROT 1R 24VDC
				WDK 2.5 LD ROT 1R 24VDC
				WDK 2.5 PE
				WDK 2.5 / 800V
				WDK 2.5 ZQV
				WDK 2.5 ZQV BL
				WDK 2.5/D
				WDK 2.5V
				WDK 2.5V BL
				WDK 2.5 1D A.1
				WDK 2.5 1D A.2
				WDK 2.5 2D
				WDK 2.5 2D
				WDK 2.5 2D
				WDK 2.5 BL
				WDK 2.5 D

Ordering data

Type	Colour	Qty	Order No.	For terminal:
WAP WTR2.5/ZZ	dark beige	20	1074600000	WTR 2.5/ZZ
WAP WTR2.5/ZZ BL	blue/light blue	20	1074680000	WTR 2.5/ZZ BL
Width				
WAP WDU/WTR4/ZR	dark beige	50	1905070000	WDU 4/ZR
WAP WDU/WTR4/ZZ	dark beige	50	1905150000	WDU 4/ZZ
				WPE 4/ZR
				WPE 4/ZZ
				WTR 4/ZR
				WTR 4/ZR STB
				WTR 4/ZZ
				WTR 4/ZZ STB
Width				
WAP WDL2.5/S	dark beige	20	1067700000	WDL 2.5/S/L
WAP WDL2.5/S RS-SET	dark beige	5	1819210000	WDL 2.5/S/L/L
				WDL 2.5/S/L/L/PE
				WDL 2.5/S/N/L/PE
				WDL 2.5/S/NT/L/PE
Width				
WAP WDL2.5	beige	20	1067800000	WDL 2.5/L
				WDL 2.5/L/L
				WDL 2.5/L/L/PE
				WDL 2.5/N/L/PE
				WDL 2.5/NT/L/PE
Width				
WAP WDU1.5/BLZ	dark beige	50	1577330000	WDU 1.5/BLZ 5.08
WAP WDU1.5/BLZ/ZA	dark beige	50	1577320000	WDU 1.5/ZQV/BLZ 5.08
				WDU 2.5/BLZ/7.62
Width				
WAP WDK2.5/BLZ/M.ZA	blue	20	1070100000	WDK 2.5 BLZ/5.08/ZA
WAP WDK2.5/BLZ/O.ZA	dark beige	20	1070000000	WDK 2.5 BLZ/7.62/ZA
Width				
AP DLI2.5	beige	20	1313260000	DLA 2.5 DB
AP DLI2.5 DB	dark beige	20	1783550000	DLA 2.5/D DB
				DLA 2.5/LD-GN/D DB
				DLA 2.5/LD-RT DB
				DLI 2,5 DB
				DLI 2.5/LD-GN/NPN +- DB
				DLI 2.5/LD-GN/PNP +- DB
				DLI 2.5/LD-RT/NPN +- DB
				DLI 2.5/LD-RT/PNP +- DB
Width				
AP DLD2.5 DB	dark beige	20	1784210000	DLD 2.5 DB
AP DLD2.5/PE DB	dark beige	20	1783800000	DLD 2.5/PE DB
Width				
WAP WTL6/1	dark beige	20	1068300000	WTD 6/1 EN
				WTL 6/1 EN
				WTL 6/1 EN STB
				WTL 6/1/STB/TNSC/EN
				WTQ 6/1 EN
				WTQ 6/1 EN STB
Width				
ZAP/TW 1	dark beige	50	1608740000	WTL 4
ZAP/TW 1 BL	blue/light blue	50	1608750000	WTL 4/STB
ZAP/TW 1 GN	green	50	1683680000	
ZAP/TW 1 GR	grey	50	1683710000	
ZAP/TW 1 OR	Orange	50	1608760000	
ZAP/TW 1 RT	red	50	1683660000	
Width				
WAP WDU1.5/R3.5	beige	20	1754190000	WDK 1.5/R3.5
				WDK 1.5/R3.5 BL
				WDU 1.5/R3.5
				WDU 1.5/R3.5 BL
				WPE 1.5/R3.5
Width				
WAP WDK1.5/R3.5	dark beige	20	1754200000	WDK 1.5/R3.5
				WDK 1.5/R3.5 BL
Width				
AP AKZ1.5	beige	50	0340560000	AKZ 1.5
AP AKZ1.5 BL	blue	50	0340580000	AKZ 1.5 BL
Width				
AP AKZ2.5	beige	50	0697360000	AKZ 2.5
AP AKZ2.5 BL	blue	50	0697380000	AKZ 2.5 BL
AP AKZ2.5K	beige	50	0697260000	

Accessories - Optical separation / lateral cover

Ordering data

Type	Colour	Qty	Order No.	For terminal:
Width				
ADL	beige	2	0210800000	AKZ 4
AP AKZ4 DB	beige	20	9537910000	AKZ 4 BL
AP 100 GR	grey	20	1773410000	
AP AKZ4	beige	20	0294460000	
AP AKZ4 BL	blue	20	0294480000	
AP AKZ4 KRG	dark beige/yellow	20	0294420000	
AP AKZ4 KRS	anthracite	20	0294430000	
Width				
WAP WDU2.5N/4N	dark beige	50	1060000000	WDU 2.5N
WAP WDU2.5N/4N RS-SET	dark beige	5	1819180000	WDU 2.5N BL
WAP WDU2.5N/4N BL	blue/light blue	50	1060080000	WDU 2.5N ZQV
WAP WDU2.5N/4N GE	yellow	50	1060090000	WDU 2.5N ZQV BL
WAP WDU2.5N/4N OR	Orange	50	1060060000	WDU 4N
				WDU 4N BL
				WPE 2.5N
				WPE 4N
Width				
WAP WDK2.5/4 N	dark beige	20	1084000000	WDK 2.5N
WAP WDK2.5/4 N BL	Orange	20	1084080000	WDK 4N V
WAP WDK2.5/4 N GR 7042	grey	20	1859010000	WDK 2.5N DU-PE
				WDK 2.5N PE
				WDK 2.5N V
				WDK 2.5N/BL
				WDK 4N
				WDK 4N BL
				WDK 4N DU-PE
				WDK 4N PE
Width				
WAP WTL6/3	beige	20	1879910000	WTL 6/3
Width				
WAP WTL 6 SL	beige	20	9538110000	WTD 6 SL
				WTD 6 SL/EN
				WTL 6 SL
				WTL 6 SL/EN
				WTL 6 SL/EN SW
Width				
WAP WTL4/2	beige	50	1881640000	WTL 4/2/STB
Width				
WAP WTL6/4FF	beige	20	1887240000	WTL 6/4FF
Width				
WAP WSI4/2	beige	50	1880450000	WSI 4
				WSI 4/LD 60-150V AC/DC
				WSI 4/2
				WSI 4/2/LD 10-36V AC/DC
				WSI 4/2/LD 140-250V AC/DC
				WSI 4/2/LD 30-70V AC/DC
				WSI 4/2/LD 60-150V AC/DC
				WSI 4/LD 10-36V AC/DC
				WSI 4/LD 140-250V AC/DC
				WSI 4/LD 30-70V AC/DC
Width				
AP VLI1.5 DB	dark beige	20	1784150000	VLI 1.5
AP VLI1.5/PE DB	dark beige	20	1784160000	VLI 1.5 DB
				VLI 1.5/PE
				VLI 1.5/PE DB
Width				
AP MAK2.5 DB	dark beige	20	7917000000	MAK 2.5
				MAK 2.5 DB
Width				
WAP WFF120	dark beige	20	1073000000	WFF 120
WAP WFF35	dark beige	20	1069700000	WFF 70/AH
WAP WFF70	dark beige	20	1069800000	WFF 120 BL
				WFF 120/3/B
				WFF 120/AH
				WFF 35
				WFF 35 BL
				WFF 35/AH
				WFF 70
				WFF 70 BL

Partition walls

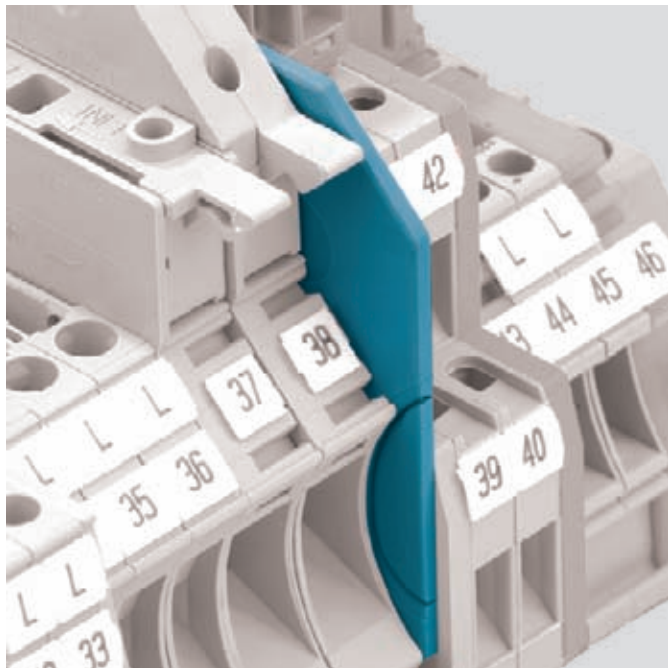

Ensuring the operating voltage

The main function of the partitions is to maintain the clearance and creepage distances, as required by the operating voltage. This includes applications with higher security levels (ATEX) or neighbouring groups of cross-connections. For this reason, the partitions are significantly larger than the corresponding terminals.

Optical separation

The partitions can be used to achieve a very clear separation of circuits on one terminal strip.

Dimensions

WAP 16+35 WTW 2.5-10

Length: 60 mm
Height with TS 35 x 7.5: 63 mm

WTW EN

Length: 86 mm
Height with TS 35 x 7.5: 63 mm

Ordering data

Type	Colour	Qty	Order No.	For terminal:
WAP 16+35 WTW 2.5-10	dark beige	20	1050100000	WDK 2.5 / 800V
WAP 16+35 WTW 2.5-10 BL	blue/light blue	20	1050180000	WDK 2.5 FF
WAP 16+35 WTW 2.5-10 GR	grey	20	1879140000	WDU 1.5/ZZ
WAP 16+35 WTW 2.5-10 OR	Orange	20	1050160000	WDU 1.5/ZZ BL
				WDU 10
				WDU 10 BL
				WDU 10 SL
				WDU 10 SL/EN
				WDU 10 SL/EN SW
				WDU 10/ZR
				WDU 10/ZR BL
				WDU 16/ZA
				WDU 16/ZA BL
				WDU 2.5
				WDU 2.5 BL
				WDU 2.5 F 2X2.8
				WDU 2.5 F 2*2.8
				WDU 2.5/1.5/ZR
				WDU 2.5/1.5/ZR BL
				WDU 2.5/TC TYP B
				WDU 2.5/TC TYP E
				WDU 2.5/TC TYP J
				WDU 2.5/TC TYP K
				WDU 2.5/TC TYP N
				WDU 2.5/TC TYP SR
				WDU 2.5/TC TYP T
				WDU 2.5N/600 UL
				WDU 35/IK/ZA
				WDU 4
				WDU 4 BL
				WDU 4 SL
				WDU 4 SL/EN
				WDU 4 SL/EN SW
				WDU 6
				WDU 6 BL
				WDU 6 SL
				WDU 6 SL/EN
				WDU 6 SL/EN SW
				WDUL 4 100R/0.75W POTI
				WDUL 4 10K/0.75W POTI
				WDUL 4 10R/0.75W POTI
				WDUL 4 1K/0.75W POTI
				WDUL 4 500K/0.1W POTI
				WDUL 4 500R/0.75W POTI
				WDUL 4 50K/0.75W POTI
				WDUL 4 5K/0.75W
				WDUL 4 OHNE POTI
				WPE 1.5/ZZ
				WPE 10
				WSI 6
Width				
WTW EN	dark beige	20	1058800000	SAKS 2/35 DB
				WDK 2.5N DU-PE
				WDK 2.5N PE
				WDK 2.5N V
				WDK 2.5N/BL
				WDK 2.5V
				WDK 2.5V BL
				WDK 4N PE
				WDU 16N
				WDU 16N BL
				WDU 35N
				SAKS 4/35 DB
				WDU 35N BL
				WTD 6 SL
				WTD 6 SL/EN
				WTL 6 SL
				WTL 6 SL/EN
				WTL 6 SL/EN SW
				SAKS 5/35 DB
				WDK 2.5
				WDK 2.5 BL
				WDK 2.5 DU-PE
				WDK 2.5 ZQV
				WDK 2.5 ZQV BL
				WDK 2.5N

Accessories – Cover strips and retaining plates

Several German safety regulations, e.g. VBG 4 and VDE 0106 part 100, call for the active parts of electrical equipment to be protected against direct contact.

For this purpose, Weidmüller can supply cover strips and associated retaining plates which can be used for the common sizes of terminal. Retaining plates are fitted at the ends of a terminal strip but can also be inserted between terminals. They are suitable for mounting on TS 32, TS 35 or TS 15 terminal rails.

Spacing of retaining plates:

The distance between the retaining plates for the ADP 1, 2 and 3 cover strips should not exceed about 300 mm.

The cover strip is clipped into lugs at the sides, but can also be fixed to spigots on the retaining plates which can be provided with a lead seal. The cover strips are transparent so that terminals with accessories and markings can be identified at any time. Additional markings, e.g. groups, can be attached to the cover strips.

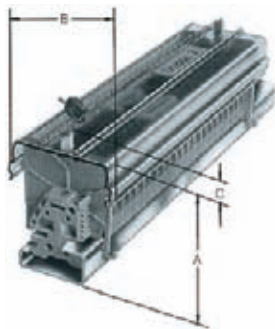

ADP

Cover strips



Material: unplasticised PVC
Supplied in 1 m lengths
Temperature limit: max. 70 °C

transparent

Type	Order No.
ADP 1 	0485200000
ADP 2 	0485300000
ADP 3 	0485400000
grey	
ADP 4 (1000 mm) 	1430760000
ADP 4 (300 mm) 	1378160000
TSK 31.5 	0347960000

HP

Retaining plates



Material: PA 66
Thickness: 2 mm

For mounting on TS 35 / TS 32, with spigot for lead seal

Type	Order No.
HP 1 	0485560000
HP 2 	0485660000
HP 3 	0485760000
HP 4 	0485860000

For mounting on TS 15

Type	Order No.
HP 7 	0258260000
HP 8 	0258360000

Covers

Overall dimensions	A	A	A	A	B	C
for mounting on terminal rails	TS 32	TS 35 x 7.5	TS 35 x 15	TS 15		
ADP 1, HP 1	61	56	63		49	6
ADP 2, HP 2	77	72	79		62.5	6
ADP 3, HP 3	94	89	86		92	6
ADP 3, HP 4	73.5	68.5	75.5		92	6
ADP 1, HP 8				45	49	6
TSK 31.5, HP 7				35	31	6
Marking materials						
Card with warning "lightning flash", self adhesive						Qty. 5
20 pcs. per card						Order No. 0566700000

Potential supply with cross-section reduction

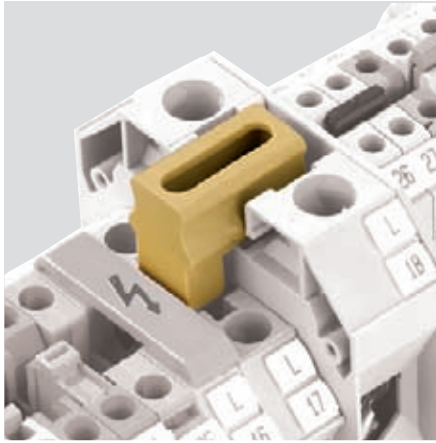

Mounting

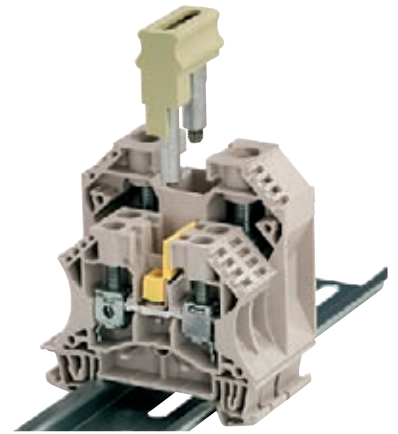

Feed-through terminals such as WDU 35 or WDU 16 are responsible for power supply in the W-Series. The current is routed by the cross-connections shown to terminals of a smaller cross-section (cross-section reduction).

After cross-section reduction, the supply can then be distributed on to any number of terminals of this same cross-section, using standard cross-connectors.

Function

- Larger conductor cross-section can be used for power supply
- Central current supply and distribution to any number of circuits

First, prepare the **standard cross-connection** that is to distribute the current to other terminals of smaller conductor cross-section. To do so, break off the plastic screwdriver guide at the first pole of the cross-connection by bending it back and forth at the intended break-off point, and remove the fixing screw. Then place the cross-connection in the middle of the terminal.

Now insert the **cross-connection for cross-section reduction** so that there is an overlap of the live parts of the first terminal of the smaller cross-section. Fasten with the screws in the cross-section reduction.

Important! The “QL” cross-section reductions are not finger-safe. This can be easily remedied by using the WAD covers for the corresponding terminals.

Potential supply with cross-section reduction

Power supply via

Output terminal

WDU 35

WDU 2.5



WDU 35

WDU 4 / WDU 6



WDU 35

WDU 10



Technical data	
Continuous current 2-pole	A
Thread size	
Tightening torque	Nm
Ordering data	
	2-pole

to WDU 35	to WDU 2.5	
41	M 4	M 2.5
	1.2 ... 1.8	0.4 ... 0.7
Type	Qty.	Order No.
WQV 35-2.5	10	1064100000

to WDU 35	to WDU 4 / 6	
41	M 4	M 3
	1.2 ... 1.8	0.5 ... 0.8
Type	Qty.	Order No.
WQV 35-4/6	10	1064200000

to WDU 35	to WDU 10	
57	M 4	M 3
	1.2 ... 1.8	0.5 ... 0.8
Type	Qty.	Order No.
WQV 35-10	10	1068000000

Power supply via

Output terminal

WDU 16

WDU 2.5



WDU 16

WDU 4 / WDU 6



Technical data	
Continuous current 2-pole	A
Thread size	
Tightening torque	Nm
Ordering data	
	2-pole

to WDU 16	to WDU 2.5	
41	M 4	M 2.5
	1.2 ... 1.8	0.4 ... 0.7
Type	Qty.	Order No.
WQV 16-2.5	10	1063900000

to WDU 16	to WDU 4 / 6	
41	M 4	M 3
	1.2 ... 1.8	0.5 ... 0.8
Type	Qty.	Order No.
WQV 16-4/6	10	1064000000

Power supply via

Output terminal

WDU 10

WDU 2.5



WDU 10

WDU 4



Technical data	
Continuous current 2-pole	A
Thread size	
Tightening torque	Nm
Ordering data	
	2-pole

to WDU 10	to WDU 2.5	
24	M 3	M 2.5
	0.5 ... 0.8	0.4 ... 0.7
Type	Qty.	Order No.
QL 10-2.5	10	1859620000

to WDU 10	to WDU 4	
32	M 3	M 3
	0.5 ... 0.8	0.5 ... 0.8
Type	Qty.	Order No.
QL 10-4	10	1859610000

not finger-safe

not finger-safe

Accessories – Potential supply

Potential supply with cross-section reduction

Power supply via
Output terminal

WDU 16N
WDU 2.5



WDU 16N
WDU 4 / WDU 6



WDU 6
WDU 2.5



Technical data	
Continuous current 2-pole	A
Thread size	
Tightening torque	Nm
Ordering data	
	2-pole

to WDU 16		to WDU 2.5	
24			
M 3		M 2.5	
0.5 ... 0.8		0.4 ... 0.7	
Type	Qty.	Order No.	
WQV 16N-2.5	10	1073100000	

to WDU 16N		to WDU 4 / 6	
41			
M 3		M 3	
0.5 ... 0.8		0.5 ... 0.8	
Type	Qty.	Order No.	
WQV 16N-4/6	10	1072500000	

to WDU 6		to WDU 2.5	
24			
M 3		M 2.5	
0.5 ... 0.8		0.4 ... 0.7	
Type	Qty.	Order No.	
QL 6-2,5	10	1859600000	
not finger-safe			

ZQV plug-in cross-connection

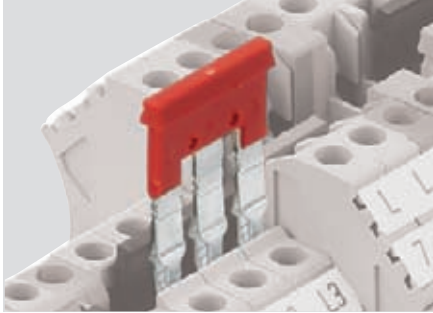

Weidmüller are the leading manufacturer of plug-in cross connection systems for screw clamp terminals. The plug-in cross-connections stand out with their easy handling and quick assembly, resulting in considerable time savings compared to screwed assembly solutions. This also ensures that all poles remain securely in contact.

Assembly / Technical information

- The ZQV is pressed into the cross-connection channel by hand.
- **Important!** Ensure that the ZQV is pressed right in. The cross-connection must not protrude out of the cross-connection channel.
- To replace or remove, simply lever out with a screwdriver.
- Finger-safe to VDE 0160 part 100 (VGB4)
- Reduced rated voltage 400 V
- Different colours can be used to mark different potential
- **Important!** The contact elements must not be deformed

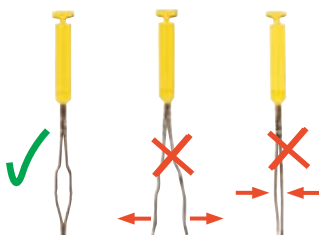

In one cross-connection channel



In two cross-connection channels

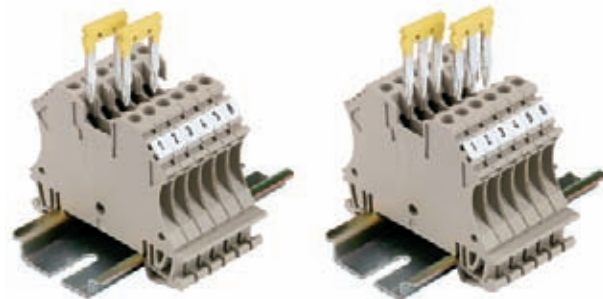

Possible cross-connections of terminals of the same type with corresponding cross-connectors

Terminal type	Cross-connector	single	adjacent	bridging	parallel bridging	parallel lengthening
Standard						
WDU 1.5/ R3.5	ZQV 1.5/ R3.5	•	•	•		
WDK 1.5/ R3.5	ZQV 1.5/ R3.5	•	•	•		
WDU 2.5/1.5/ZR	ZQV 2.5N	•	•	•	•	•
WDU 2.5	ZQV 2.5N	•	•	•	•	•
WDK 2.5 ZQV	ZQV 2.5N	•	•	•		
WTR 2.5/ZZ	ZQV 2.5	•	•	•		
WDU 4	ZQV 4N	•	•	•	•	•
WTR 4...	ZQV 4N	•	•	•		
WDU/PE/4ZZ/ZR	ZQV 4N	•	•	•	•	•
WTR 4/ZZ/ZR	ZQV 4N	•	•	•		
Compact						
WDU 2.5N ZQV	ZQV 2.5N	•	•	•	•	•
WDK 2.5N...	ZQV 2.5N	•	•	•		
WDK 2.5N PE	ZQV 2.5N	•	•	•		
WDU 4N	ZQV 4N	•	•	•	•	•
WDK 4N...	ZQV 4N	•	•	•		
WDK 4N PE	ZQV 4N	•	•	•		

ZQV 2.5N

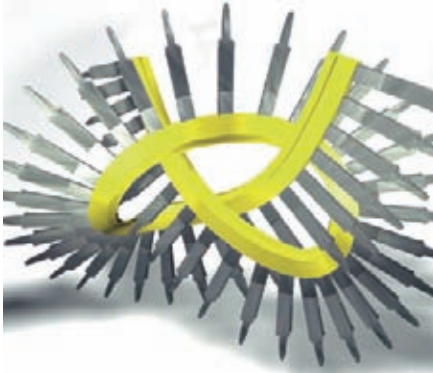

Continuous cross-connection

ZQV 2.5N/20 (20-pole) and ZQV 4N/20 (20-pole) are ideal for shortening (e.g. with tool KT ZQV – 9002170000) to produce customised configurations with the required number of poles. More than 20 poles in a row are not recommended because of the resulting tolerances in the terminals.

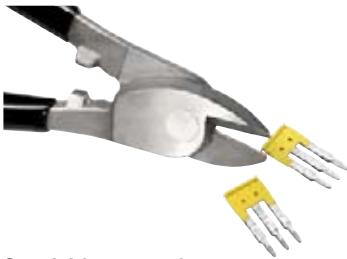

Special features of

WDU 2.5, WDU 4 and WDU 2.5/1.5/ZR

- Parallel distribution of 3 potentials
Important! Rated voltage reduced to 125 V!
- Parallel distribution of 2 potentials
Important! Only when using the outer cross-connection holes at 400 V
- The middle cross-connection hole can be used for either ZQV or WQV

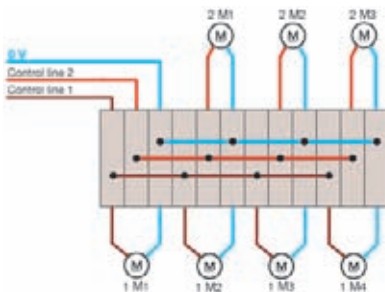

Important! For shortened ZQV located adjacent to each other (with bare cut edges), end plates or partition plates are necessary for rated voltage of 250 V.

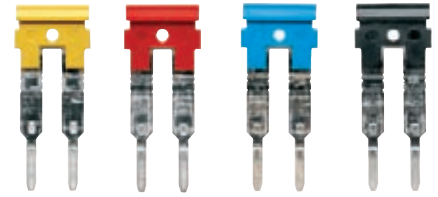

No. of poles	Type	I [A]	Qty.	Order No. yellow	Order No. red	Order No. blue	Order No. black
2	ZQV 2.5N/2	24	60	1693800000	1717900000	1717990000	1718080000
3	ZQV 2.5N/3	24	60	1693810000	1717910000	1718000000	1718090000
4	ZQV 2.5N/4	24	60	1693820000	1717920000	1718010000	1718100000
5	ZQV 2.5N/5	24	20	1693830000	1717930000	1718020000	1718110000
6	ZQV 2.5N/6	24	20	1693840000	1717940000	1718030000	1718120000
7	ZQV 2.5N/7	24	20	1693850000	1717950000	1718040000	1718130000
8	ZQV 2.5N/8	24	20	1693860000	1717960000	1718050000	1718140000
9	ZQV 2.5N/9	24	20	1693870000	1717970000	1718060000	1718150000
10	ZQV 2.5N/10	24	20	1693880000	1717980000	1718070000	1718160000
20	ZQV 2.5N/20	24	20	1909000000	1909110000	1909140000	1909130000

For standard terminal	For compact terminal
WDU 2.5/1.5 ZR	WDU 2.5N
WDU 2.5	WDK 2.5N
WDK 2.5/ ZQV	WDK 2.5N V
WDU 1.5 BLZ 5.08/ ZQV	WDK 2.5N DU-PE

ZQV 4N

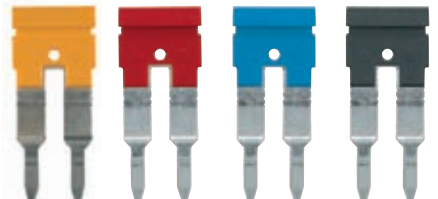

No. of poles	Type	I [A]	Qty.	Order No. yellow	Order No. red	Order No. blue	Order No. black
2	ZQV 4N/2	32	60	1758250000	1793950000	1793960000	1793970000
3	ZQV 4N/3	32	60	1762630000	1793980000	1793990000	1794000000
4	ZQV 4N/4	32	60	1762620000	1794010000	1794020000	1794030000
5							
6							
7							
8							
9							
10	ZQV 4N/10	32	20	1758260000	1794040000	1794050000	1794060000
20	ZQV 4N/20	32	20	1909020000	1909150000	1909100000	1909120000

For standard terminal	For compact terminal
WDU 4	WDU 4N
WTR 4	WDK 4N
WTR 4 SI	WDK 4N V
WTR 4 SL	WDK 4N DU-PE
WTR 4/ZZ+ZR	WDK 2.5N V
WDU/PE4/ZZ+ZR	WDK 2.5N DU-PE

WQV screw-in cross-connection

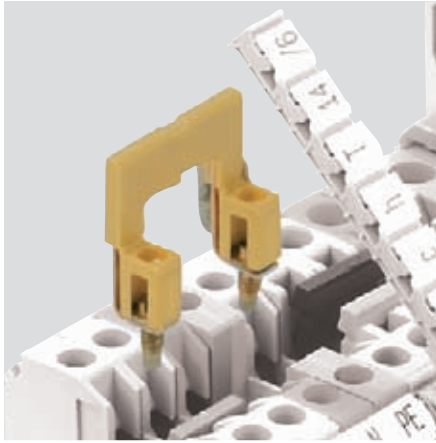

When used together with W-Series terminals, WQV insulated cross-connection units guarantee absolute safety for finger and back-hand in accordance with the accident prevention regulation “Electrical systems and equipment” (VGB4). It is very easy to produce individual configurations thanks to the many different options offered by the WQV cross-connection system, by breaking out individual segments, creating any required number of poles or routing two potentials in parallel, etc.

Technical instructions

- The full rated current of the terminals can be routed across any number of poles
- No end plates or partition plates needed for adjacent WQV up to 400 V.

Assembly

- Place the WQV in the cross-connection channel in the middle of the terminal and screw tight.
- Individual WQV segments can be broken out by bending over or using the WAW1 tool (9004500000). It is then possible to bridge individual or several terminals.
- Captive fixing screws.
- Snap onto the clamped support – simple overhead assembly.

Any number of poles (extending)

Pre-fitted cross-connections can be set one after the other to produce any required number of poles.

To do so, arrange the last and first contact points of two identical WQVs so that they overlap.

- First, remove the fixing screw and screwdriver guide (insulated part) at one of the outer contact points of one of the WQVs.



- Then insert the WQV without fixing screw and insulated part. At the same time, insert an unmodified WQV in parallel so as to produce an overlap at the connection. The connection is screwed tight using the fixing screw of the unmodified WQV.



Routing 2 potentials in parallel

- In spite of only having 1 channel, the WQV cross-connection system can still be used for offset cross-connections. See the photo “parallel bridging” (page E.107).

WQV in combination with a socket contact and test plug

- Remove the fixing screw and insulation part of the WQV. Screw the socket in at this point. This now makes it possible to integrate a safe test point.

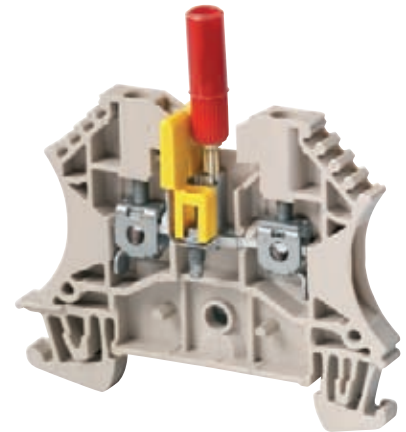

Potential distribution – possible combinations

In one cross-connection channel

single

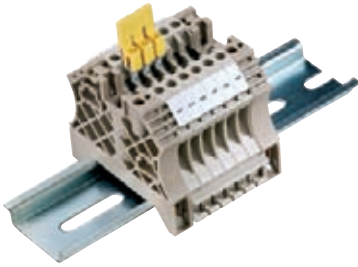

adjacent

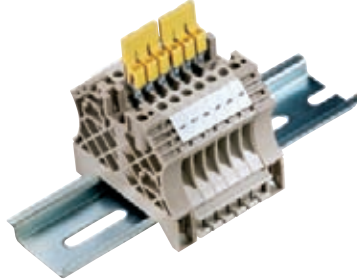

bridging

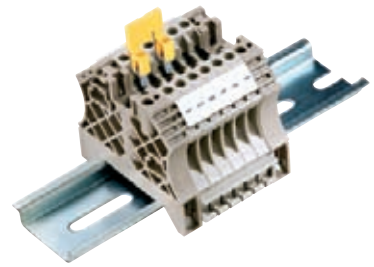

parallel/bridging

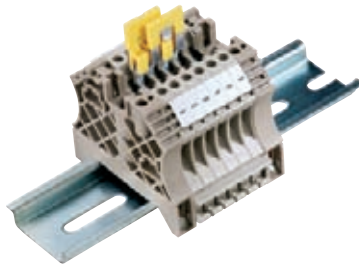

lengthening

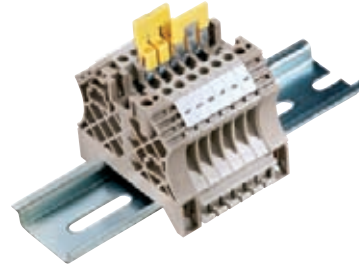

Possible cross-connections of terminals of the same type with appropriate cross-connectors

Terminal type	Cross-connector	single	adjacent	bridging	parallel/bridging	parallel/lengthening
Standard						
WDU 1.5/ZZ	WQV 2.5	•	•	•	•	•
WDU 1.5/BLZ	WQV 2.5	•	•	•	•	•
WDU 2.5/1.5/ZR	WQV 2.5	•	•	•	•	•
WDU 2.5 - WDU 35	WQV 2.5 - WQV 35	•	•	•	•	•
WDK 2.5...	WQV 2.5	•	•	•	•	•
WDK 2.5 PE	WQV 2.5	•	•	•	•	•
WDU 2.5/BLZ	WQV 2.5	•	•	•	•	•
WDK 2.5/BLZ	WQV 2.5	•	•	•	•	•
WDU 2.5 F...	WQV 2.5	•	•	•	•	•
WDK 2.5 F...	WQV 2.5	•	•	•	•	•
WDU 4... - WDU 35...	WQV 4 - WQV 35	•	•	•	•	•
WDU 70/95	WQV 70/95	•	•			
WDU 120/150	WQV 120/150	•	•			
WDU 240	WQB 240	•	•			
Compact						
WDU 2.5N	WQV 2.5	•	•	•	•	•
WDU 2.5N 600V	WQV 2.5	•	•	•	•	•
WDU 16N	WQV 16N	•	•	•	•	•
WDU 35N	WQV 35N	•	•			
WDU 50N	WQV 50N	•	•			
WDU 70N	WQV 70N	•	•			
WDU 95N/120N	WQV 95N/120N	•	•			

Accessories - Electrical distribution

WQV 2.5



Technical data	
current	A
Type of fixing	Screwed
Pitch	mm
Ordering data	
2-pole	
3-pole	
4-pole	
5-pole	
6-pole	
7-pole	
8-pole	
9-pole	
10-pole	
15-pole	
20-pole	
32-pole	

/ 32		
Screwed		
5.10		
Type	Qty	Order No.
WQV 2.5/2	50	1053660000
WQV 2.5/3	50	1053760000
WQV 2.5/4	50	1053860000
WQV 2.5/5	10	1053960000
WQV 2.5/6	10	1054060000
WQV 2.5/7	10	1054160000
WQV 2.5/8	10	1054260000
WQV 2.5/9	10	1054360000
WQV 2.5/10	20	1054460000
WQV 2.5/15	10	1059660000
WQV 2.5/20	10	1577570000
WQV 2.5/32	10	1577600000

For terminal:
 WDU 1.5 ZZ WDK 2.5
 WDU 1.5 BLZ WDK 2.5 V
 WDU 2.5/1.5 ZR WDK 2.5 DU-PE
 WDU 2.5 WDK 2.5 F
 WDU 2.5 F

WQV 4



/ 41		
Screwed		
6.10		
Type	Qty	Order No.
WQV 4/2	50	1051960000
WQV 4/3	50	1054560000
WQV 4/4	50	1054660000
WQV 4/5	10	1057860000
WQV 4/6	10	1057160000
WQV 4/7	10	1057260000
WQV 4/8	10	1057960000
WQV 4/9	10	1058060000
WQV 4/10	20	1052060000
WQV 4/15	10	1057460000

For terminal:
 WDU 4
 WDU 4 SL

WQV 6



/ 57		
Screwed		
8.00		
Type	Qty	Order No.
WQV 6/2	50	1052360000
WQV 6/3	50	1054760000
WQV 6/4	50	1054860000
WQV 6/5	50	1062660000
WQV 6/6	50	1062670000
WQV 6/7	50	1062680000
WQV 6/10	20	1052260000

For terminal:
 WDU 6
 WDU 6 SL

WQV 35N



Technical data	
current	A
Type of fixing	Screwed
Pitch	mm
Ordering data	
2-pole	
3-pole	
4-pole	
5-pole	
6-pole	
7-pole	
8-pole	
9-pole	
10-pole	
15-pole	
20-pole	
32-pole	

/ 101		
Screwed		
16.00		
Type	Qty	Order No.
WQV 35N/2	20	1079200000
WQV 35N/3	20	1079300000
WQV 35N/4	20	1079400000

For terminal:
 WDU 35N

WQV 50N



/ 150		
Screwed		
18.50		
Type	Qty	Order No.
WQV 50N/2	5	1834060000
WQV 50N/3	5	1834070000
WQV 50N/4	5	1834080000

For terminal:
 WDU 50N

WQV 70N



/ 192		
Screwed		
20.50		
Type	Qty	Order No.
WQV 70N/2	5	9512240000
WQV 70N/3	5	9512250000
WQV 70N/4	5	9531290000

For terminal:
 WDU 70N

WQV 10



/ 57		
Screwed		
10.00		
Type	Qty	Order No.
WQV 10/2	50	1052560000
WQV 10/3	50	1054960000
WQV 10/4	50	1055060000
WQV 10/10	20	1052460000

For terminal:
 WDU 10
 WDU 10 SL
 WDU 10 ZR

WQV 16



/ 76		
Screwed		
12.00		
Type	Qty	Order No.
WQV 16/2	50	1053260000
WQV 16/3	50	1055160000
WQV 16/4	50	1055260000
WQV 16-4/6	10	1064000000
WQV 16/10	10	1053360000

For terminal:
 WDU 16

WQV 16N



/ 76		
Screwed		
12.00		
Type	Qty	Order No.
WQV 16N/2	50	1636560000
WQV 16N/3	50	1636570000
WQV 16N/4	50	1636580000

For terminal:
 WDU 16N

WQV 35



/ 112		
Screwed		
16.00		
Type	Qty	Order No.
WQV 35/2	50	1053060000
WQV 35/3	50	1055360000
WQV 35/4	50	1055460000
WQV 35-4/6	10	1064200000
WQV 35/10	10	1053160000

For terminal:
 WDU 35

WQV 70/95



232 / 192		
Screwed		
27.00		
Type	Qty	Order No.
WQV 70/95/2	5	1063500000
WQV 70/95/3	5	1063600000

For terminal:
 WDU 70/95

WQV 95N/120N



269 / 269		
Screwed		
27.00		
Type	Qty	Order No.
WQV 95N/120N-	5	1826890000
WQV 95N/120N-	5	1826900000
WQV 95N/120N-	5	1826910000

For terminal:
 WDU 95N/120N

WQV 120



269 / 269		
Screwed		
32.00		
Type	Qty	Order No.
WQV 120/2	5	1063300000
WQV 120/3	5	1063400000

For terminal:
 WDU 120/150

Accessories - Electrical distribution

Screwable QV

Q AKZ 4 SS



Technical data	
current	A
Type of fixing	Screwed
Pitch	mm
Ordering data	
2-pole	
3-pole	
4-pole	
5-pole	
10-pole	
20-pole	

20 / 20		
Screwed		
5.10		
Type	Qty	Order No.
Q 2 AKZ4SS	50	0369000000
Q 3 AKZ4SS	50	0369100000
Q 4 AKZ4SS	50	0369200000
Q 10 AKZ4SS	20	0369300000
For terminal:		
WDK 2.5 / 800 V		

Q / DLI



20 / 20		
Screwed		
5.00		
Type	Qty	Order No.
Q 2 DLI	50	1312500000
Q 3 DLI	50	1312600000
Q 4 DLI	50	1312700000
Q 5 DLI	50	1312800000
Q 10 DLI	20	1313100000
Q 20 DLI	20	1399800000
For terminal:		
DLI 2.5 DLA 2.5 DLD 2.5		

Q AKZ 1.5



/ 24		
Screwed		
5.10		
Type	Qty	Order No.
Q 2 AKZ1.5	50	0368200000
Q 3 AKZ1.5	50	0368300000
Q 4 AKZ1.5	50	0368400000
Q 10 AKZ1.5	20	0368500000
For terminal:		
AKZ 1.5 AKZ 2.5		

Screwable QV

Q AKZ 4



Technical data	
current	A
Type of fixing	Screwed
Pitch	mm
Ordering data	
2-pole	
3-pole	
4-pole	
5-pole	
10-pole	
20-pole	

32 / 32		
Screwed		
6.10		
Type	Qty	Order No.
Q 2 AKZ4	50	0336400000
Q 3 AKZ4	50	0336500000
Q 4 AKZ4	50	0336600000
Q 10 AKZ4	20	0368600000
For terminal:		
AKZ 4		

Q / WDL



/ 24		
Screwed		
6.10		
Type	Qty	Order No.
Q 2 WDL2.5S	50	1071500000
Q 3 WDL2.5S	50	1071600000
Q 4 WDL2.5S	50	1071700000
Q 10 WDL2.5S	20	1071800000
Q 20 WDL2.5S	20	1074200000
For terminal:		

WDL 2.5/S...(with 10 x 3 busbar)
WDL 2.5 (With isolator, external side)

Accessories for stud terminals

Potential distribution

The power distribution between neighbouring stud terminals can be achieved simply with the use of 2- and 3-pole cross-connections (see the section under stud terminals).

However, a cross-section reduction is required in special cases. These so-called cross-connection lugs are available for thread sizes from M6 to M10 and can be combined as required. This is helpful for power supplies and power distribution, for example.

WQL

Special cross-connection lugs

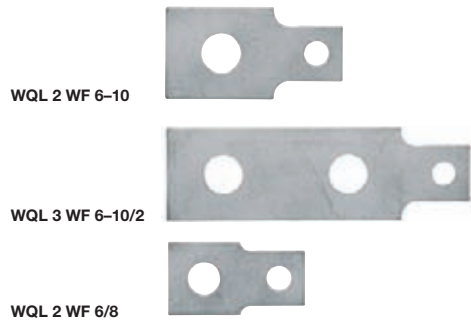

Type	Current [A]	Qty.	Order No.	Primary stud connection [M...]	Neighbouring stud connection [M...]
WQL 2 WF 6-10 t = 4 mm	125	5	1806620000	WF 6 = 1 pole M 6	1 x WF 10 = 1 pole M 10
WQL 3 WF 6-10/2 t = 4 mm	125	5	1806640000	WF 6 = 1 pole M 6	2 x WF 10 = 2 poles M 10
WQL 2 WF 6/8 t = 4 mm	125	5	1808980000	WF 6 = 1 pole M 6	1 x WF 8 = 1 pole M 8
WQL 4 WF 8-6/3 t = 4 mm	125	5	1904960000	WF 8 = 1 pole M 8	3 x WF 6 = 3 poles M 6

Cross-connections with test-disconnect terminal / fuse terminal WSI 6

Installation

Screw the cross-connection lugs QL X SAK6N directly to the current bar (Order No. 1052100000 KISC M3X5). To do this, push out the pre-punched side window of the terminal carrier with the help of tool WAW 2 (order No. 9004510000) and clip the terminal in place. Now open the fuse holder and insert the fixing screw. Slip the cross-connection lug in through the punched opening in the side of the terminal carrier and secure it with the fixing screw.

Important! The side window of the last terminal may not be broken out as otherwise the rated voltage cannot be guaranteed.

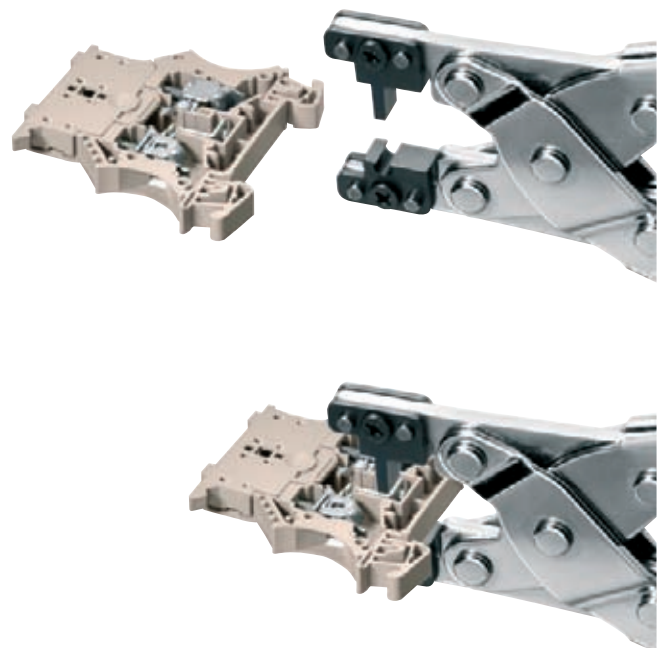

External cross-connection bridges

Function

External cross-connection bridges allow for current to be bridged in terminals without a cross-connection channel in the middle or when two potentials are to be routed in parallel.

Assembly

These bridges are positioned over the conductor in the clamping point and connected. Individual contacts can be separated off by hand when you wish to skip a clamping point.

Important! Use of these parts reduces the nominal cross-section of the connected conductor to the next smallest size for the terminal in question.

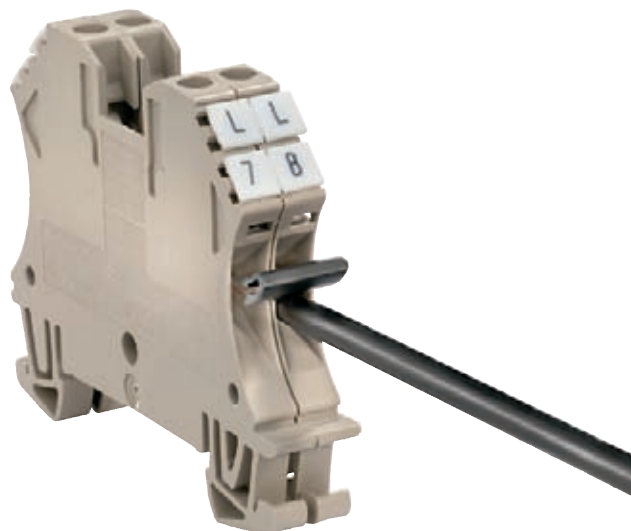

QL ... for WSI 6

Pitch 6.3 mm



WQB A / ...

Pitch 5.1 mm



WQB B / ...

Pitch 5.1 mm



Technical data

	QL ... for WSI 6	WQB A / ...	WQB B / ...
Continuous current 2-pole/multi-pole	A		
Fork length	mm		
	24 / 24	24 / 24	24 / 24
	12	12	16

Ordering data

	Type	Qty.	Order No.	Type	Qty.	Order No.	Type	Qty.	Order No.
2-pole	QL 2	100	0194300000	WQB A / 2	50	1578950000	WQB B / 2	50	1579010000
3-pole	QL 3	100	0194400000	WQB A / 3	50	1578960000	WQB B / 3	50	1579020000
4-pole	QL 4	50	0194500000	WQB A / 4	50	1578970000	WQB B / 4	50	1579030000
10-pole	QL 10	20	0338300000	WQB A / 10	50	1578990000	WQB B / 10	50	1579050000
24-pole	QL 10	20	0338300000	WQB A / 24	50	1579000000	WQB B / 24	50	1579060000
Fixing screw	BS-M 3 x 5	100	1052100000						
Releasing tool	WAW 2	1	9004510000						
	Releasing tool			Releasing tool			Releasing tool		
	WSI 6...			WDK 2.5			WDU 1.5 / ZZ (lower connection level)		
							WDU 2.5		
							WDU 2.5 / 1.5 / ZR (lower connection level)		
							WTR 2.5		

Testing in terminals

PS

Test plug



Test plugs (PS) are used for measurements or final testing of ready wired terminal strips. Test plugs are available for socket contacts with an internal diameter of 2.3 mm or 4 mm.

The difference to the test adapter is that the test plug does not slot into the terminal. This means that reliable plugging into feed-through terminals up to 35 mm² is only possible with a socket.

Special feature for large cross-sections

WDU 70N, WDU 95N/120N, WDU 70/95, WDU 120/150

In these terminals, test plug PS 4 can be plugged into the head of the clamping screw for measurements.

Ordering data

Test plug	Qty.	Order No.
2.3 mm diameter / rated current 17.5 A		
PS 2.3	20	0180400000
4.0 mm diameter / rated current 24 A		
PS 4	20	0299600000

StB

Socket



The StB socket is used for fitting the PS test plug. The sockets are screwed into the busbar in the cross-connection channel in the middle of the terminal. The WTR test-disconnect terminals are available with pre-assembled sockets (refer to the W-Series test-disconnect terminals). The sockets are equipped with a slot for the screwdriver. A special screwdriver blade guarantees that the sockets are securely tightened (see catalogue 6, chapter F).

Combining with WQV

The socket can be used in combination with the WQV screw-in crossconnection. For this purpose, the insulating part of the screw and the fixing screw have to be removed at the corresponding pole in the WQV. The socket can then be screwed in.

Ordering data

Socket	For test plug	Qty.	Order No.	For standard terminal	For compact terminal
Thread M 2.5 / Length 11.5 mm					
StB 8.5	PS 2.3	50	0215700000	WDU 1.5/ZZ WDU 2.5/1.5/ZR WDU 2.5 WDK 2.5...	WDU 2.5N (WQV) WDU 2.5N 600V UL
Thread M 3 / Length 12 mm					
StB 8.5	PS 2.3	50	0280600000	WDU 4 WDU 6 WDU 10 WDU 10/ZR	
Thread M 3 / Length 19 mm					
StB 14	PS 4	50	0169900000	WDU 10 WDU 10ZR	WDU 16N
Thread M 4 / Length 23 mm					
StB 16	PS 4	50	0140200000	WDU 16	WDU 35N
Thread M 3 / Length 23 mm (finger-safe)					
StB 21.6	PS 4	50	1071000000	WDU 4 WDU 10	WDU 6

Accessories - Testing / checking

Test adapter

WTA 1



Dimensions	
Width / Length / Height	mm
Stripping length	mm
Rated data	
Rated voltage	V
Rated current	A
Rated cross-section	mm ²
Clamped conductors (H05V/H07V)	
solid / stranded	mm ²
flexible / Flexible with ferrule	mm ²
Ordering data	
1-pole	
With snap-in pegs	
10-pole	

5 / 66.1 / 98.2			
6			
IEC	UL	CSA	
250	300	300	
6	6	6	
1.5			
0.5...1.5			
1...1.5 / 0.5...1.5			
Type	Qty	Order No.	
WTA 1 WDU1.5	25	1632290000	
WTA 1/ZA WDU1.5	25	1632300000	
For terminal:			
WDU 2.5N			
WDU 4N			

WTA 2



5 / 66.1 / 107.6			
6			
IEC	UL	CSA	
250	300		
6			
1.5			
0.5...1.5			
1...1.5 / 0.5...1.5			
Type	Qty	Order No.	
WTA 2 WDU2.5-10	25	1632320000	
WTA 2/ZA WDU2.5-10	25	1632330000	
WTA 2/10 WDU2.5/10	5	1632340000	
For terminal:			
WDU 1.5 ZZ	WDU 4		
WDU 2.5/1.5 ZR	WDU 6		
WDU 2.5	WDU 10		
WDU 2.5 F	WDU 16		

WTA 3



6 / 66.1 / 107.6			
6			
IEC	UL	CSA	
250	300		
6			
1.5			
0.5...1.5			
1...1.5 / 0.5...1.5			
Type	Qty	Order No.	
WTA 3 WDU4	25	1632350000	
WTA 3/ZA WDU4	25	1632360000	
WTA 3/10 WDU4/10	5	1632370000	
For terminal:			
WDU 4			
WDU 6			
WDU 10			

Test adapter

WTA 6



Dimensions	
Width / Length / Height	mm
Stripping length	mm
Rated data	
Rated voltage	V
Rated current	A
Rated cross-section	mm ²
Clamped conductors (H05V/H07V)	
solid / stranded	mm ²
flexible / Flexible with ferrule	mm ²
Ordering data	
1-pole	
With snap-in pegs	
10-pole	

5 / 66.1 / 107.6			
6			
IEC	UL	CSA	
250	300	300	
6	6	6	
1.5			
0.5...1.5			
1...1.5 / 0.5...1.5			
Type	Qty	Order No.	
WTA 6 WTR2.5	25	1632380000	
WTA 6/ZA WTR2.5	25	1632390000	
For terminal:			
WTR 2.5			

WTA 7



6 / 68 / 120			
6			
IEC	UL	CSA	
250	300		
6			
1.5			
0.5...1.5			
1...1.5 / 0.5...1.5			
Type	Qty	Order No.	
WTA 7 WSI6	25	1650210000	
For terminal:			
WSI 6			

WTA 4N



5 / 62 / 111.6

IEC	UL	CSA
250	300	
6		
1.5		

0.5...1.5

1...1.5 / 0.5...1.5

Type	Qty	Order No.
WTA 4N WDK 2.5	25	1878660000
WTA 4N/ZA WDK 2.5	25	1879350000

For terminal:

WDK 2.5
WDK 2.5 V
WDK 2.5 F
WDK 2.5 FV

WTA 5



5 / 17 / 68.2

IEC	UL	CSA
250	300	
6		
0.75		

0.5...1

1...1 / 0.5...1

Type	Qty	Order No.
WTA 5/1	25	1051260000
WTA 5/10	5	1062060000

For terminal:

WDU 2.5 WDU 10
WDU 4 WDU 10 ZR
WDU 6

Test adapter

Dimensions

Width / Length / Height mm
Stripping length mm

Rated data

Rated voltage V
Rated current A
Rated cross-section mm²

Clamped conductors (H05V/H07V)

solid / stranded mm²
flexible / Flexible with ferrule mm²

Ordering data

red
red
green
green
beige
beige

WTA 8



6 / 39 / 78

IEC	UL	CSA
205		
6		
1.5		

0.5...2.5

Type	Qty	Order No.
WTA 8 TN-KO/ZA	25	1915520000
WTA 8 TN-KO	25	1915470000
WTA 8 KO-TN/ZA	25	1915510000
WTA 8 KO-TN	25	1915480000
WTA 8 TN/ZA	25	1915500000
WTA 8 TN	25	1915450000

For terminal:

WTL 4/2 StB

TN-KO = Isolate - Contact
KO-TN = Contact - Isolate
TN = Isolate

Accessories - Marking

Labelling / cover

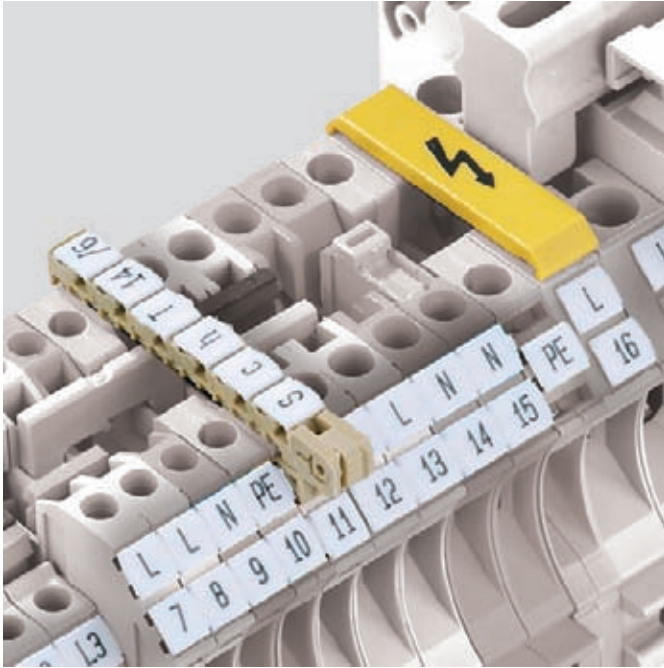

The WAD cover is snapped on to the centre of the terminal on the cross-connection channel, from the top down. The covers are delivered in yellow with a black lightning flash symbol and also in white without markings.

The WAD covers are available for all feed-through terminals in the W-Series.

Labelling of mains terminals

VDE regulations require that mains terminals be labelled with „Warning Voltage“ and a lightning flash symbol.

Convenient labelling options

A white cover with no print is well suited for manual terminal labelling or for group labelling.

Touch protection with uninsulated cross-connections

Important! When cross-connecting the WDU 70N, WDU 95N/120N, WDU 70/95 and WDU 120/150, touch protection is guaranteed by the cover, in compliance with VDE directives.

WAD

Type	Colour	Qty	Order No.	For terminal:
Width				
WAD 4 GE BED	yellow	50	1072000000	WDK 2.5
WAD 4 WS	white	50	1072100000	WDK 2.5 / 800V
				WDK 2.5 BL
				WDK 2.5 DU-PE
				WDK 2.5 F
				WDK 2.5 F BL
				WDK 2.5 FF
				WDK 2.5 FV
				WDK 2.5 ZQV
				WDK 2.5 ZQV BL
				WDK 2.5/D
				WDK 2.5V
				WDK 2.5V BL
				WDU 1.5/ZZ
				WDU 1.5/ZZ BL
				WDU 2.5 F 2X2.8
				WDU 2.5 FF 2*2.8
				WDU 2.5N
				WDU 2.5N BL
				WDU 2.5N ZQV
				WDU 2.5N ZQV BL
				WDU 2.5N/600 UL
				WDU 4N
				WDU 4N BL
Width				
WAD 5 NEUTRAL	white	50	1056060000	WDU 2.5
WAD 5 M. BL.	yellow	50	1053460000	WDU 2.5 BL
				WDU 2.5/1.5/ZR
				WDU 2.5/1.5/ZR BL
				WDU 4
				WDU 4 BL
				WDU 6
				WDU 6 BL
Width				
WAD 8 NEUTRAL	white	50	1056160000	WDU 10
WAD 8 M. BL.	yellow	50	1053560000	WDU 10 BL
Width				
WAD 12 NEUTRAL	white	50	1056260000	WDU 16/ZA
WAD 12 M. BL.	yellow	50	1055960000	WDU 16/ZA BL
				WDU 16N BL
				WDU 35/IK/ZA
				WDU 35/ZA
				WDU 35/ZA BL
Width				
WAD 12N GE BED	yellow	50	1073200000	WDU 16N
WAD 12N WS	white	50	1073290000	
Width				
WAD 16N GE BED	yellow	50	1083600000	WDU 16N
WAD 16N WS	white	50	1083500000	WDU 35N
				WDU 35N BL
Width				
WAD 20 GE WSD	yellow	10	9512260000	WDU 50N
WAD 20 WS	white	10	9512270000	WDU 50N BL
				WDU 70N/35
				WDU 70N/35 BL
				WDU 95N
				WDU 95N BL
Width				
WAD 27 NEUTRAL	white	10	1062960000	WDU 120
WAD 27 M. BL.	yellow	10	1062860000	WDU 120 BL
				WDU 70/95
				WDU 70/95 BL

SIHA fuse holder

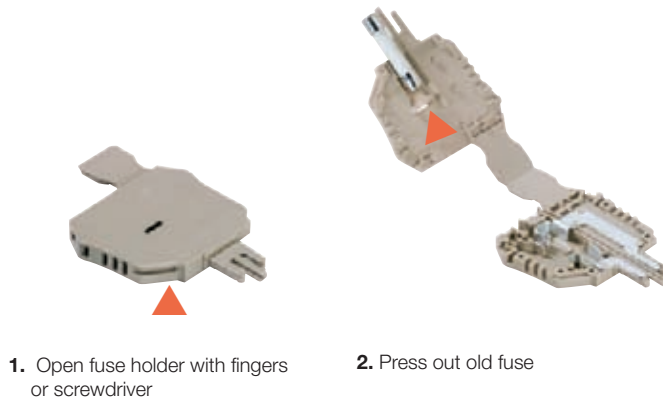
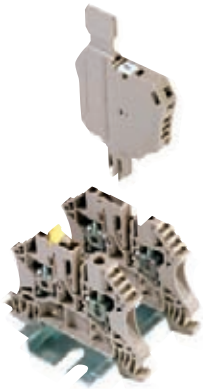

1. Open fuse holder with fingers or screwdriver

2. Press out old fuse

For 5x20 G-fuse cartridges

The SIHA fuse holder turns a test-disconnect terminal into a fuse terminal in seconds:

Simply remove the isolating lever and insert the fuse plug

- Simple handling – no tools required
- Housing made of Wemid (V0)
- Rated current 6.3 A
- 1.6 W power loss to DIN VDE 0611-6 at 23 °C ambient temperature (also for 1.5 times rated current – composite arrangement)
- Even fits on 5 mm wide terminals when fitted in offset arrangement
- Marking position for Dekafix 5 and space for self-adhesive label size 8/20

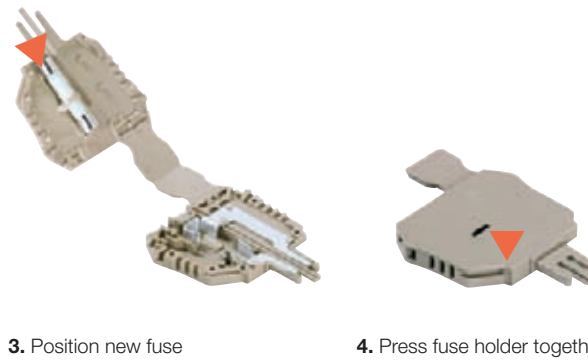

3. Position new fuse

4. Press fuse holder together again

SIHA 1

SIHA 3

SIHA STRAP



	Qty.	Order No.
without LED		
SIHA1/G20		
400 V	1	9537550000
with LED (red)		
SIHA1/G20		
10 - 36 V	1	9537560000
35 - 70 V	1	9537570000
60 - 150 V	1	9537580000
140 - 250 V	1	9537590000

For test-disconnect terminal versions
WTR 2.5/ZZ

	Qty.	Order No.
without LED		
SIHA3/G20		
400 V	1	7921560000
with LED (red)		
SIHA3/G20		
10 - 36 V	1	7921570000
35 - 70 V	1	7921580000
60 - 150 V	1	7921590000
140 - 250 V	1	7921600000

For test-disconnect terminal versions
WTR 4
WTR 4/ZZ
WTR 4/ZR
WTR 2.5

	Qty.	Order No.
with strap		
SIHA STRAP		
	20	9537680000

Connector for "retro-fit" assembly

- Receptacle in the terminal is the marking position
- Integrated marking position on the strap
- Slots into fuse holder either left or right

Cartridge fuses

Technical data

For terminal type

WSI 4
WSI 6



G-type cartridge fuses 5 x 20 without indicators to IEC 60127-2 (VDE 0820 pt.2 BI¹⁾

Size (mm)	Nom. current (A)	Type
5 x 20	0.1	(F) G 20/0.10A/F
	0.2	(F) G 20/0.20A/F
breaking capacity 1500 A (at 250 V, 50 Hz, cos φ 0.7)	0.25	(F) G 20/0.25A/F
	0.5	(F) G 20/0.50A/F
	0.63	(F) G 20/0.63A/F
	1.0	(F) G 20/1.00A/F
	1.6	(F) G 20/1.60A/F
	2.0	(F) G 20/2.00A/F
	2.5	(F) G 20/2.50A/F
	3.15	(F) G 20/3.15A/F
	4.0	(F) G 20/4.00A/F
	5.0	(F) G 20/5.00A/F
	6.3	(F) G 20/6.30A/F

(M) = medium-blow (F) = fast-blow

Ordering data

Qty.	Order No.
10	0430300000
10	0430400000
10	0430500000
10	0430600000
10	0439000000
10	0430700000
10	0430800000
10	0430900000
10	0431000000
10	0431100000
10	0431200000
10	0431300000
10	0431400000

WSI 6



G-type cartridge fuses 5 x 25 with indicators to DIN 41576¹⁾

5 x 25 w. indicator ²⁾	0.25	(M) G 25/0.25A/M
breaking capacity 80 A (at 250 V, 50 Hz, cos φ = 1)	0.5	(M) G 25/0.50A/M
	0.8	(M) G 25/0.80A/M
	1	(M) G 25/1.00A/M
	10	(M) ³⁾ G 25/10.0A/M
	2	(F) G 25/2.00A/F
	4	(F) G 25/4.00A/F
	6.3	(F) G 25/6.30A/F

(M) = medium-blow (F) = fast-blow

WSI 4/2
WSI 6/2



Cartridge fuses 1¼" x ¼" without indicators to BS 88

33 kA breaking capacity, 33 kA fast-blow	0.5	GZ 0.5A/F	10	0533800000
E 0.5 A	1	GZ 1.0A/F	10	0525500000
E 1 A	2	GZ 2.0A	10	0294500000
E 2 A	3	GZ 3.0A	10	0295700000
E 3 A	5	GZ 5.0A	10	0294600000
E 5 A	7	GZ 7.0A	10	0295800000
E 7 A	10	GZ 10.0A	10	0293900000
E 10 A	12.5	GZ 12.5A/FF	10	0245400000

(F) = fast-blow (M) = medium-blow

SAKS 2



D-type cartridge fuses E 16 with indicators to DIN 49360 (Diazed)

E 10 A	10	E 16/10A RT	25	0208500000
E 16 A	16	E 16/16A GR	25	0208600000
E 20 A	20	E 16/20A BL	25	0208700000
E 25 A	25	E 16/25A GE	25	0208800000

(F) = fast-blow (M) = medium-blow

SAKS 4⁴⁾



D-type cartridge fuses E 14 size D 01 and E 18 size D 02 with indicators to DIN 49522 (Neozed)⁵⁾

E 14/2	2	E 14/2A RS	10	0137400000
E 14/4	4	E 14/4A BR	10	0137500000
E 14/6	6	E 14/6A GN	10	0328300000
E 14/10	10	E 14/10A RT	10	0328400000
E 14/16	16	E 14/16A GR	10	0328500000
E 18/20	20	E 18/20A BL	10	0361300000
E 18/25	25	E 18/25A GE	10	0361400000
E 18/35	35	E 18/35A SW	10	0361500000
E 18/50	50	E 18/50A WS	10	0361600000
E 18/63	63	E 18/63A KU	10	0361700000

(F) = fast-blow (M) = medium-blow

SAKS 5



¹⁾ SIBA also supplies G-type cartridge fuses 5 x 25 with indicators suitable for 450 V~ shipbuilding applications.

²⁾ Cartridge fuses 5 x 30 (500 V~) for SAKS 3 are available from the WICKMANN company.

³⁾ LINDNER also supplies the Neozed cartridge fuses in another version suitable for 440 V~ shipbuilding applications.

⁴⁾ Cartridge fuses in the sizes 1"x¼" (25.4x6.35 mm) and 13/32"x1½" (10.3x38.1 mm) are not included in the range.

⁵⁾ For SAKS 1 and SAKS 7 only.

Gauge pieces

Technical data

For terminal type
SAKS 4/35

SAKS 5/35

SAKS 2/35

Gauge piece type	Amps	Colour	Type
P 14/2	2	pink	P 14/2D01 RS
P 14/4	4	brown	P 14/4D01 BR
P 14/6	6	green	P 14/6D01 GN
P 14/1	10	red	P 14/10D01 RT
P 18/20	20	blue	P 18/20D02 BL
P 18/25	25	yellow	P 18/25D02 GE
P 18/35	35	black	P 18/35D02 SW
P 18/50	50	white	P 18/50D02 WS
P 16/10	10	red	P 16/10 RT
P 16/16	16	grey	P 16/16 GR
P 16/20	20	blue	P 16/20 BL

Ordering data

Qty.	Order No.
50	0138000000
50	0138100000
50	0328600000
50	0328700000
50	0361800000
50	0361900000
50	0362000000
50	0362100000
100	0208900000
100	0209000000
100	0209100000

Component isolating plugs

The Weidmüller philosophy is to realise a multitude of applications with just a few parts. The component and isolating plugs (BEST and TNST) represent a logical extension of this cost-effective and efficient approach. The component plug can accommodate electronic components and connect them to the terminal. And once an isolating plug is removed, the clamping point is obviously disconnected. The opening is easy to recognise.

An unintentional reconnection of the circuit is prevented by simply removing the isolating plug. The BEST and the TNST have the same pin arrangement. Both plugs are also identical with the SIHA 3 fuse holder, meaning that they can be used in all the “disconnecting products” of the W-, Z-, I- and P-Series.

Component plug (up to 250 V)

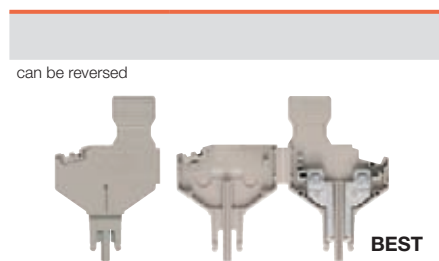

Ordering data

Type	Fitted with...	Qty.	Order No.
BEST	without	25	1833100000
BEST/DRBR	wire jumper	25	1878570000
BEST/D	diode 1N4007	25	1878560000

For terminal type

- WTR 2.5
- WTR 4
- WTR 4/ZZ
- WTR 4/ZR

Isolating plug

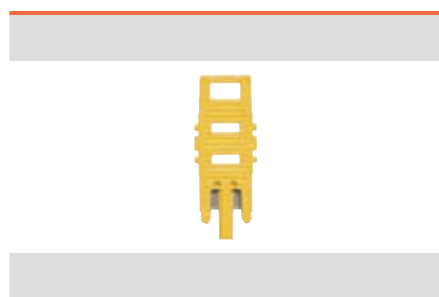

Ordering data

Type	Colour	Qty.	Order No.
TNST	Wemid, yellow	25	1833090000

For terminal type

- WTR 2.5
- WTR 4
- WTR 4/ZZ
- WTR 4/ZR

Accessories – Specific functions and variations

Screen plug (LS)

A screen plug (LS) is available for many terminals in the W-Series. The bar can be used to continue the shielding over the terminals as an interface. There is no direct connection to earth potential.

Assembly

The screen plug is placed flat in the bottom of the terminal in the recess provided. At the ends, the shield can be plugged in with a 2.8 mm Faston connector or also soldered on.

Reduced rated voltage

The smaller clearance and creepage sections result in a reduced voltage rating in the terminal when using the screen plug.

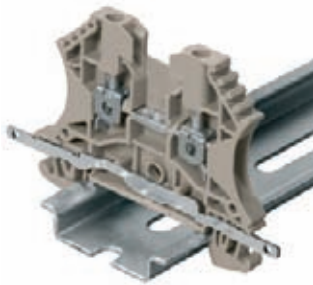

LS 2.8

Type	Qty.	Order No.
LS 2.8 WDU2.5-10	50	1056400000

Reduced voltage

For standard terminal	Reduced voltage
WDU 1.5/ZZ	400 V
WDU 2.5/1.5/ZR	400 V
WDU 2.5	400 V
WDU 4	400 V
WDU 6	400 V
WDU 10	400 V
WDK 2.5 ZQV	250 V
WDK 2.5 (WQV)	250 V
WTR 2.5...	250 V

For compact terminal	Reduced voltage
WDK 2.5N	250 V
WDK 4N	250 V

Short-circuit plug (WDS)

Short-circuit plugs (cross-connection plugs) are used together with sockets (diameter 2.3 mm) for easily disconnected cross-connection of terminals.

In the real world, this connector is used very often with test-disconnect terminals. Thanks to its insulated grip, the WDS is touch-safe.

Assembly

The plug is simply plugged onto the socket and locks automatically.

For terminal width 5.1 mm



WDS

Type	Qty.	Order No.
WDS 2	20	1069900000

Reduced voltage

For terminal
WDU 1.5/ZZ
WDU 2.5/1.5/ZR
WDU 2.5
WDK 2.5... (WQV)
WTR 2.5...
WDU 2.5 F...

Extension connector (WZAD)



An extension connector (WZAD) is offered for feed-through terminals from 70 mm².

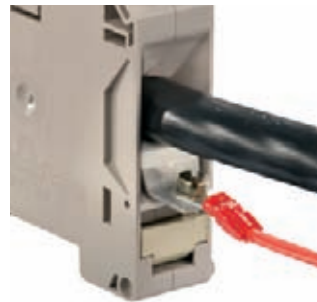

Assembly

This connector consists of a metal part which is pushed into the terminal and lodges behind the clamping yoke. The WZAD extension connector is connected to the "main" conductor in the terminal. Another conductor of up to 4 mm² and 32A can be screwed to the outer end of the extension connector using a ring cable lug.

Exception WZAD WDU 240

The extension connector for WDU 240 is separately plugged into the terminal above the wire entry and locks automatically. The conductor is connected with a fully insulated screw connection.

WZAD

Type	Clamped conductor	Rated current	Qty.	Order No.	For terminal
WZAD 70/95	up to 4 mm ²	32 A	10	1066000000	WDU 70/95
WZAD 120/150	up to 4 mm ²	32 A	10	1066100000	WDU 120/150
WZAD 240	up to 10 mm ²	57 A	5	1802810000	WDU 240
WZAD 50N	up to 10 mm ²	40 A	5	1872720000	WDU 50N
WZAD 70N	up to 4 mm ²	32 A	10	9512280000	WDU 50N/70N
WZAD 95N/120N	up to 10 mm ²	41 A	5	1959580000	WDU 95N/120N

WZAD

Type	Clamped conductor	Rated current	Qty.	Order No.	For terminal
WZAF 35	4 mm ²	32 A	10	1070500000	WFF 35
WZAF 70	4 mm ²	32 A	10	1066200000	WFF 70
WZAF 120	4 mm ²	32 A	10	1066300000	WFF 120
WZAF 185	4 mm ²	32 A	10	1066400000	WFF 185
WZAF 300	4 mm ²	32 A	10	1066500000	WFF 300

PEN bridges

Energy distribution for machines or in buildings usually consists of 5-conductor systems (TN-S). By contrast, energy supply mains are frequently rated as 4-conductor connection. A PEN bridge joins separate PE and N conductors into one PEN conductor, creating the transition from a TN-S to a TN-C system.

Standard installation

Depending on the terminal type, inside or outside PEN bridges are available for both PE and N conductor terminals from 10 mm²

Important! For outside bridges, please note that in this context only the next smaller rated cross-section (than standard) can be connected.

Building installation with N-conductor isolation

Special external cross-connections (WQB-PEN) are available for neutral-conductor test-disconnect terminals (WNT). These establish contact between the NT and PE terminals. This results in an earthed neutral conductor with protection function in three-phase systems.

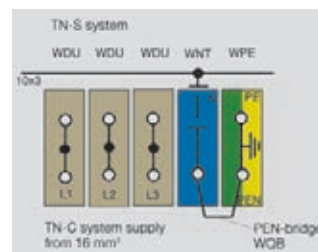

External PEN bridge



Inside PEN bridge



WQB-PEN ...

Type	Qty.	Order No.	For terminal
with standard terminals			
WQB-PEN 10	10	1060300000	WPE 10 WDU 10 BL
WQB-PEN 16	10	1060200000	WPE 16 WDU 16 BL
WQB-PEN 3	10	1060100000	WPE 35N WDU 35N BL
with neutral-conductor test-disconnect terminals			
WQB-PEN 16N	10	1079600000	WNT 16N WPE 16N
WQB-PEN 35N	10	1079500000	WNT 35N WPE 35B
WQB-PEN 70N	10	1079700000	WNT 70N WPE 70N

WQV ... -PEN

Type	Qty.	Order No.	For terminal
WQV 16N-PEN	10	1071360000	WPE 16N WDU 16N BL
WQV 70N-PEN	5	9201620000	WPE 70N WDU 70N BL
WQV 70/95-PEN	5	1072300000	WPE 70/95 WDU 70/95 BL
WQV 120-PEN	5	1072400000	WPE 120/150 WDU 120/150 BL
WQV 50N-PEN		9201610000	WPE 50N WDU 50N
WQV 95N/120N-PEN		9201620000	WPE 95N/120N WDU 95N/120N

TN-S system:

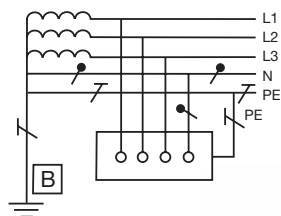

TN-C system:

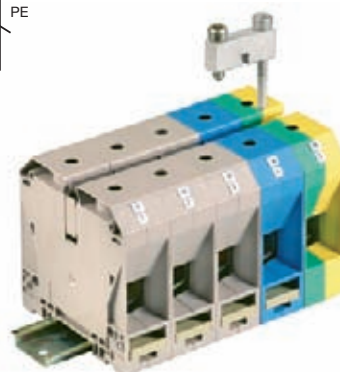
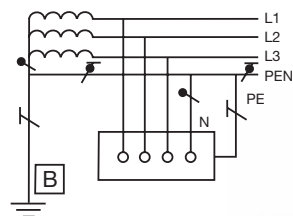

Accessories – Colour alternatives



The colours listed are available as standard. Other terminal types can be supplied in customised colours on request for quantities exceeding the minimum quantity.

Standard design

	Colour	Qty	Order No.
WDU 2.5			
WDU 2.5 OR	orange		1020060000
WDU 2.5 BR	brown		1037710000
WDU 2.5 GE	yellow		1020020000
WDU 2.5 GN	green		1020090000
WDU 2.5 GR	grey		1037720000
WDU 2.5 RT	red		1020040000
WDU 2.5 SW	black		1020010000
WDU 2.5 VI	violet		1037700000
WDU 2.5 WS	white		1036800000
WDK 2.5			
WDK 2.5 OR	orange		1021560000
WDK 2.5 WS	white		1790900000
WDK 2.5 V			
WDK 2.5 V OR	orange		1022360000
WDK 2.5 V GE	yellow		1022350000
WDU 4			
WDU 4 OR	orange		1036760000
WDU 4 BR	brown		1037810000
WDU 4 GE	yellow		1020120000
WDU 4 GN	green		1020160000
WDU 4 GR	grey		1037800000
WDU 4 RT	red		1020140000
WDU 4 SW	black		1020110000
WDU 4 VI	violet		1037820000
WDU 4 WS	white		1036700000
WDU 6			
WDU 6 OR	orange		1020260000
WDU 6 GE	yellow		1040220000
WDU 6 GR	grey		1039600000
WDU 6 RT	red		1020240000
WDU 6 SW	black		1020210000
WDU 10			
WDU 10 OR	orange		1020360000
WDU 10 GR	grey		1020320000
WDU 10 RT	red		1020340000
WSI 6			
WSI 6 OR	orange		1011060000
WSI 6 SW	black		1011010000
WSI 6 BL	blue		1011080000
WTD 6/1			
WTD 6/1 GE	yellow		1631760000
WTD 6/1 GR	grey		1017120000
WTD 6/1 RT	red		1631750000
WTD 6/1 SW	black		1631770000
WTL 6/3			
WTL 6/3 BR	brown		1018640000
WTL 6/3 GR	green		1018850000

Compact design

	Colour	Qty	Order No.
WDU 2.5			
WDU 2.5N OR	orange		1023760000
WDU 2.5N GE	yellow		1023790000
WDK 4N			
WDK 4N OR	orange		1041960000

Pre-fitted terminal blocks



Readily assembled and marked terminal blocks are available as a standard feature for smaller cross-section ranges.

Installation times can be reduced by simply slotting on complete blocks. The rating data depend on the corresponding terminal type.

Important!

- Tolerances for mounting must be heeded in project planning. A mounting tolerance of +0.1 mm must be expected for each terminal.
- In terminal blocks marked 1–9, the 10th terminal is free for decade marking
- Terminal blocks WDU 70/95 and WDU 120/150 for direct mounting only.
For direct mounting without the terminal rail please take notice of the drilling plan. Fixing with screw M6x16. (Order No. 1063700000/ VPE 20)

Drilling plan

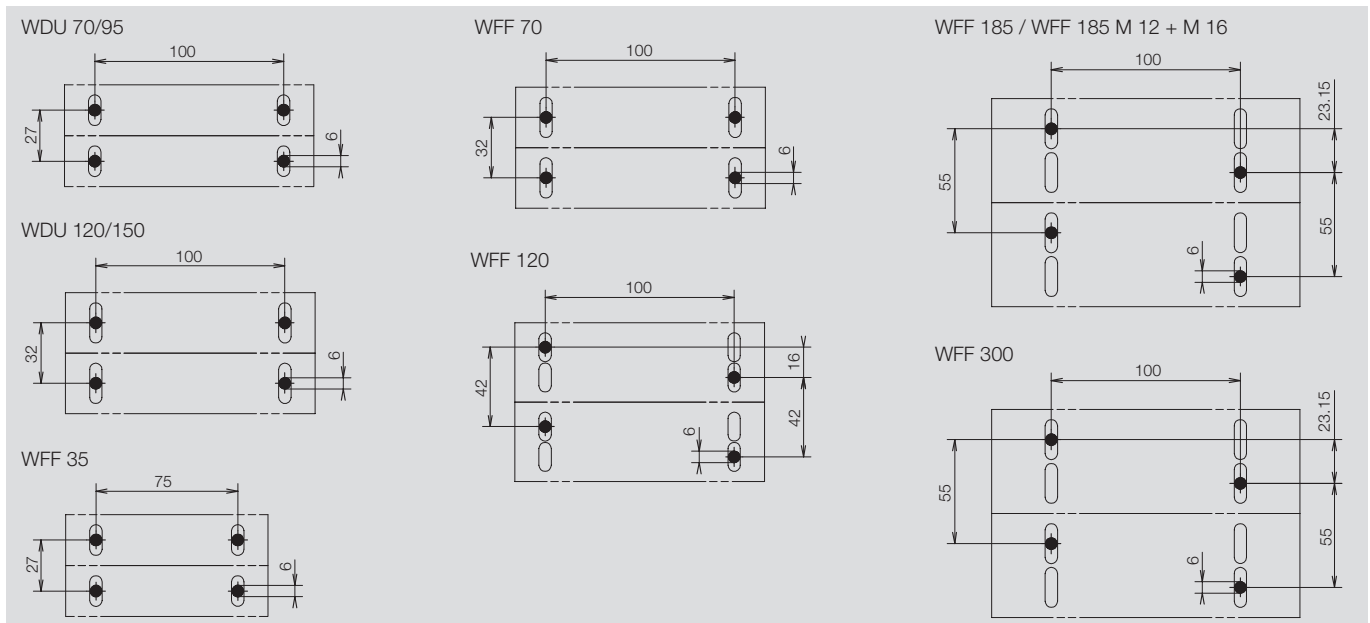

WDU 2.5	Qty	Oder No.	Description
WDU 2.5/10 BEZ	10	1020700000	10 x WDU 2.5, identified by printed marking strip DEK 5 (nos. 1 – 9)
WDU 2.5/10 BEZ/NE	10	1020800000	10 x WDU 2.5, with blank marking strip DEK 5
WDK 2.5			
WDK 2.5/10	10	1025700000	10 x WDK 2.5 (WQV), with blank marking strip DEK 5
WDK 2.5 ZQV/10/BEZ	10	1025610000	10 x WDK 2.5 (ZQV), identified by printed marking strip DEK (nos. 1-9)
WDU 4			
WDU 4/10/BEZ	10	1020900000	10 x WDU 4, identified by printed marking strip DEK 6 (nos. 1-9)
WDU 4/10	10	1021000000	10 x WDU 4 identified by blank marking strip DEK 6
WMA 4/4	20	1034000000	3 x WDU 4 (marked L1, L2, L3), WPE 4 (marked PE)
WMA 4/5	20	1033800000	3 x WDU 4 (marked L1,L2,L3), DEU 4 in blue (identified by N), WPE 4 (marked PE)
WDU 70/95			
WDU 70/95/3	4	1026700000	3 x WDU 70/95
WDU 70/95/5/N	2	1032300000	mains terminal block, 3x WDU 70/95 dark beige, 1x WDU 70/95 blue, 1 x WDU 70/95 green
WDU 120/150			
WDU 120/150/5	2	1026600000	5 x WDU 120/150
WDU 120/150/5/N	2	1032400000	mains terminal block, 3 x WDU 120/150 dark beige, 1 x WDU 120/150 blue, 1 x WDU 120/150 green
WDL 2.5			
WDL 2.5/3/S/NT/L/PE	25	1034200000	3 x WDL 2.5/S/NT/L/PE
WDL 2.5/2/NT/L/PE-L/L	20	1034100000	WDL 2.5/S/NT/L/PE and WDL 2.5/S/L/L
AKZ 1.5			
AKZ 1.5/10	10	0358060000	10 x AKZ 1.5
AKZ 1.5/10/BEZ	10	0358160000	10 x AKZ 1.5, identified by printed marking strips DEK 5 (nos. 1-9)
AKZ 4			
AKZ 4/10	10	0359560000	10 x AKZ 4
AKZ 4/10/BEZ	10	0359660000	10 x AKZ 4, identified by printed marking strips DEK 5 (nos. 1-9)
Compact design WDU 2.5N	Qty	Oder No.	Description
WDU 2.5N/10 BEZ/NE	10	1024800000	10 x WDU 2.5N, identified by printed marking strips DEK 5 (nos. 1-9)

SAK-Series / Clamping yoke screw connection technology

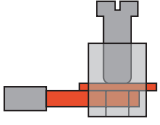

• Put to the test billions of times

Countless approvals, specifications and the world's most extensive range of terminals mean that SAK terminals can be used for a wide range of different applications.

• The right materials for every application

Ambient temperatures are not an issue for the SAK-Series thanks to different materials such as polyamide, thermoplastics and heat-resistant ceramics.

• Best conductivity and high contact force

Thanks to its design, the legendary high-strength steel screw clamp absorbs every geometric change to the connected conductor.

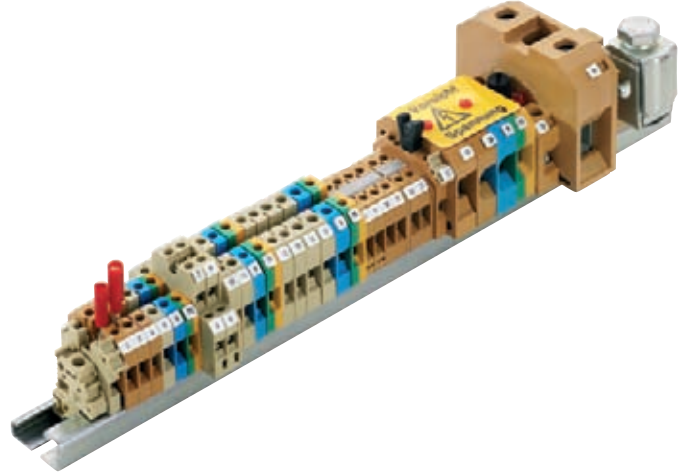

All materials checked for conformity with the latest environmental directives and RoHS requirements.

Versions

- Cross-sections from 0.5 to 35 mm²
- TS 32/TS 35 "2 in 1" combination foot



- Cross-sections from 0.5 to 95 mm²
- Special foot for TS 35
- Special foot for TS 32

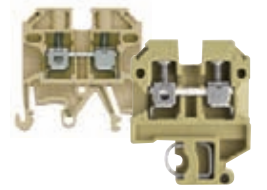

Product assortment

Terminal type	Rated cross-section						Flat-blade connection	Faston-connection	Spring-loaded	Solder connection
	2.5 mm ²	4 mm ²	6 mm ²	10 mm ²	16 mm ²	35 mm ²				
Feed-through terminals										
PA 6.6 / TS 32	•	•	•	•	•	•		•	•	•
KRG / TS 32	•	•	•	•	•	•	•	•	•	•
PA 6.6 / TS 35	•	•	•	•	•	•		•	•	•
KRG / TS 35	•	•	•	•	•	•	•			
PA 6.6 / combination foot	•	•	•	•	•	•				•
PA 6.6 / TS 15	•	•						•		
Double level terminals		•								
PE terminals										
PA 6.6 / TS 32	•	•		•	•	•				
PA 6.6 / TS 35	•	•	•	•	•	•				
PA 6.6 / TS 15	•	•								
Fuse terminals										
PA 6.6 / TS 32				•						
PA 6.6 / TS 35				•						
KrG / TS 32				•	•					
KrG / TS 35				•	•					
PA 6.6 / TS 15		•								
PA 6.6 / combination foot		•								
Double level fuse terminals										
PA 6.6 / TS 32		•								
PA 6.6 / TS 35		•								
PA 6.6 / combination foot		•								
Disconnect test terminal blocks										
TS 35		•		•						
PA 6.6 / TS 15		•								
Two-tier disconnect test terminals		•					•			
Ceramic terminals		•		•						

1 The connection

Separation of electrical and mechanical functions:

- Clamping yoke and clamping screw made from hardened steel for high contact forces.
- A copper current bar for a low through resistance. The tin-plated surface guarantees minimum contact resistance.
- Gas-tight clamping point.
- Clamping point suitable for a wide range of cross-sections.

2 Cross-connection channel

- Any number of poles can be created by stacking the pre-fitted cross-connections.

3 Easy to use

- Built-in reserve when undoing the clamping screw – particularly important for mechanical screwing tools.
- Recessed clamping screw position provides guide for screwdriver.
- All parts fitted captive within the terminal.
- Numerous labelling options.

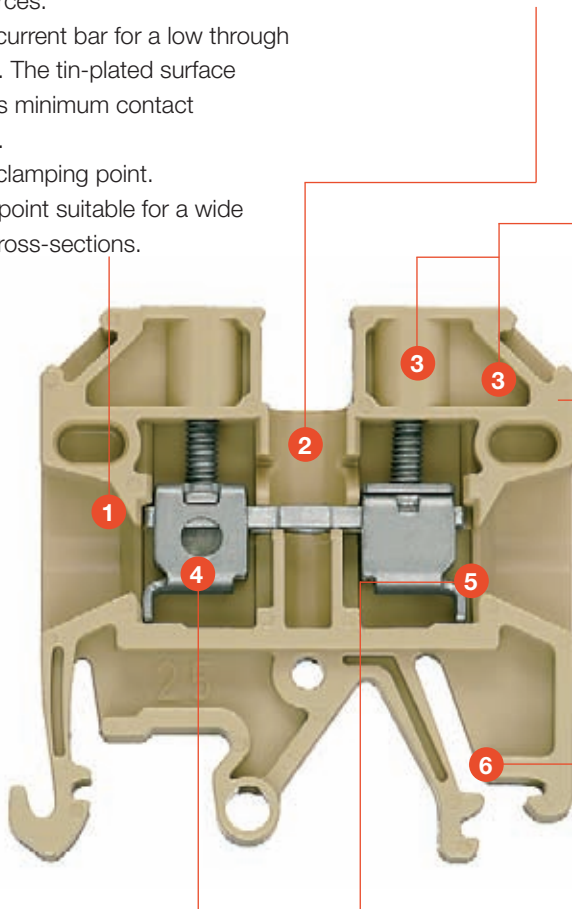

Insulating materials and max. temperatures

- PA – 100 °C
- KrG – 130 °C
- EP – 160 °C
- Ceramic – 250 °C

6 3 different snap-on feet

4 Reliable contact

- The steel clamping yoke compensates for temperature-induced changes to the conductor (no gradual loosening) required.
- Low-maintenance, vibration-resistant connection – no need to retighten the clamping screw.
- The highest contact force of any connection system – and in a compact space.

5 Safe to use

- Terminals supplied with open clamping point
- Yoke tab prevents incorrect insertion of conductors.

Standards and directives

The reliable contact and dependability of the Weidmüller systems are verified by:

- Type tests to IEC 6047-7-1/2
- National and international approvals
- A large portfolio of UL and CSA approvals
- ATEX approval
- IECEx approved



