

Slim**PAR**[™] 56

User Manual

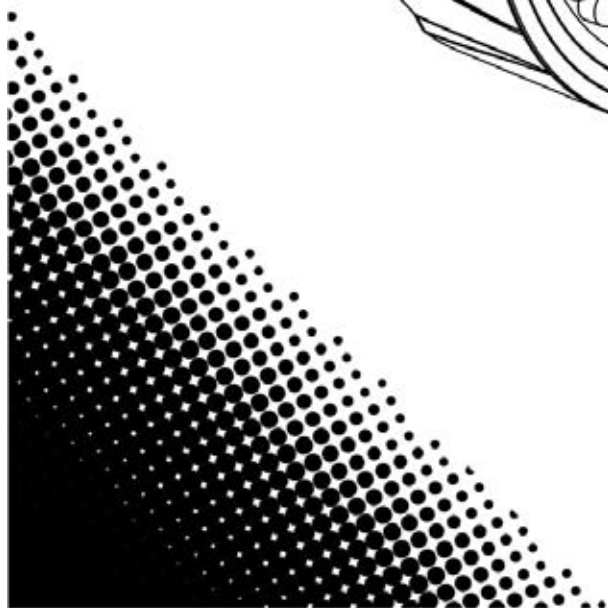
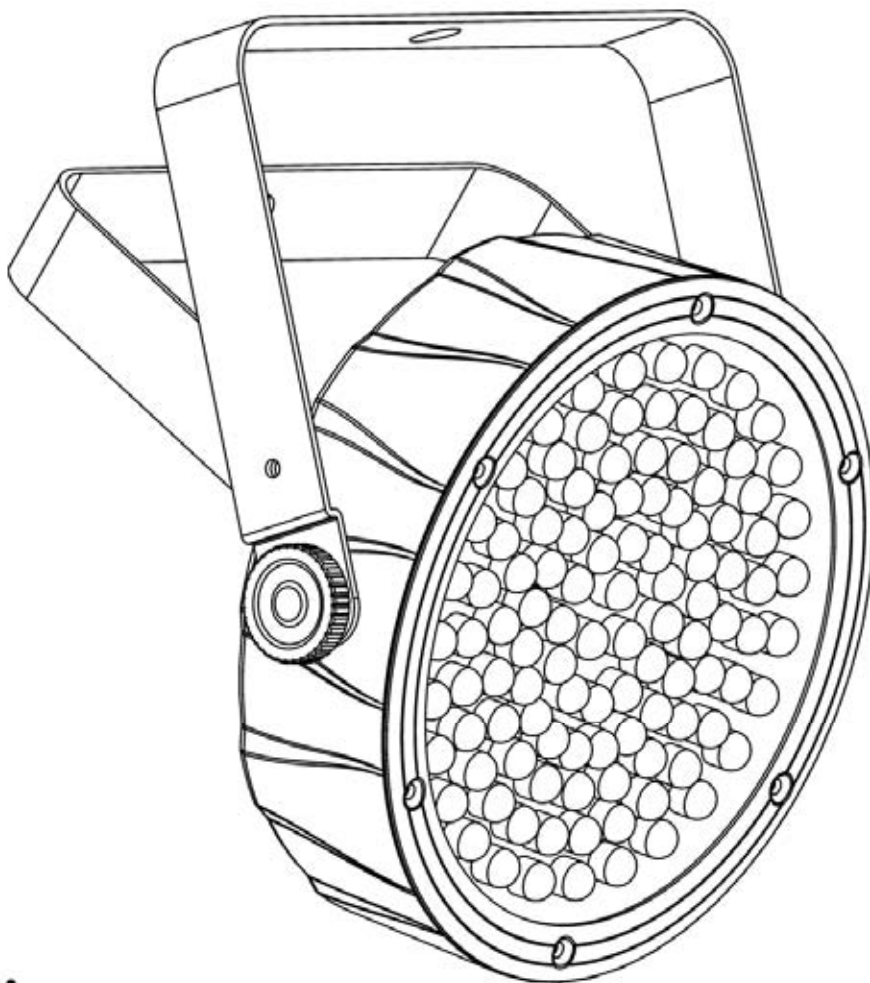

CHAUVET[®]
Value • Innovation • Performance

It's Green Thinking

TABLE OF CONTENTS

1. Before you Begin	3
What is Included.....	3
Unpacking Instructions.....	3
Text Conventions	3
Icons.....	3
Safety Notes.....	4
2. Introduction	5
Product Overview.....	5
3. Setup.....	6
AC Power.....	6
<i>Power Linking</i>	6
Mounting	7
<i>Orientation</i>	7
<i>Rigging</i>	7
4. Operation	8
Control Panel Operation.....	8
Menu Map	8
Configuration (DMX)	9
<i>Starting Address</i>	9
Configuration (Standalone)	9
<i>Sound Active Mode</i>	9
<i>Automatic Mode</i>	9
<i>Static Mode</i>	10
<i>Custom Static Colors</i>	10
<i>Master/Slave Mode</i>	10
DMX Channel Assignments and Values	11
<i>7-CH Mode</i>	11
<i>3-CH Mode</i>	11
5. Technical Information.....	12
General Maintenance.....	12
General Troubleshooting	13
Returns Procedure	14
Claims	14
Contact Information.....	14
DMX Primer.....	15
<i>Starting Address</i>	15
<i>Fixture Linking (Daisy Chain)</i>	15
<i>DMX Cabling</i>	16
6. Technical Specifications	17

Document Information

The information and specifications contained in this document are subject to change without notice. CHAUVET® assumes no responsibility or liability for any errors or omissions that may appear in this manual.

© Copyright 2011 CHAUVET®. All rights reserved

Printed in P.R.C.

Electronically published by CHAUVET® in the United States of America

Author	Editor	Manager	PD Manager
A. Chiappone	B. Pillow	A. Reiss	F. Sellers

1. BEFORE YOU BEGIN

What is Included

- 1 x SlimPART™ 56
- 1 x Power Cord
- 1 x Warranty Card
- 1 x User Manual

Unpacking Instructions

Immediately upon receiving this product, carefully unpack it and check the container in which you received it. Make sure that you have received all the parts indicated above and that they are all in good condition. If the material inside the container (this product and any other accessory included with it) appears damaged from shipping, or if the container shows signs of mishandling, notify the shipper immediately. In addition, retain the container and all the packing material for inspection.

See the *Claims* section in the “*Technical Information*” chapter.



Text Conventions

CHAUVET® manuals use the following conventions to differentiate certain types of information from the regular text.











Convention	Meaning
[10]	A DIP switch to be configured
<Menu>	A key to be pressed on the fixture's control panel
1~512	A range of values
50/60	A set of values of which only one can be chosen
Settings	A menu option not to be modified (for example, showing the operating mode/current status)
Menu > Settings	A sequence of menu options to be followed
ON	A value to be entered or selected

Icons

This manual uses the following icons to indicate information that requires special attention on the part of the user.

Icon	Meaning
	This paragraph contains critical installation, configuration, or operation information. Failure to comply with this information may render the fixture partially or completely inoperative, cause damage to the fixture, or cause harm to the user.
	This paragraph contains important installation or configuration information. Failure to comply with this information may prevent the fixture from functioning correctly.
	This paragraph reminds you of useful, although not critical, information.

Product at a Glance

Use on Dimmer		Auto Programs	
Outdoor Use		Auto-ranging Power Supply	
Sound Activated		Replaceable Fuse	
DMX		User Serviceable	
Master/Slave		Duty Cycle	

Safety Notes



Please read the following notes carefully because they include important safety information about the installation, usage, and maintenance of this product.

- Keep this User Manual for future consultation. If you sell this product to another user, be sure that they also receive this document.
- Always make sure that the voltage of the outlet to which you are connecting this product is within the range stated on the decal or rear panel of the fixture.
- This product is for indoor use only! To prevent risk of fire or shock, do not expose this fixture to rain or moisture.
- Make sure there are no flammable materials close to the unit while operating.
- Always install this product in a location with adequate ventilation, at least 20 in (50 cm) from adjacent surfaces.
- Be sure that no ventilation slots on the unit's housing are blocked.
- Always disconnect this product from the power source before cleaning it or replacing fuse.
- Make sure to replace the fuse with another of the same type and rating.
- If mounting this product overhead, always secure it to a fastening device using a safety cable.
- The maximum ambient temperature (T_a) is 104° F (40° C). Do not operate this product at higher temperatures.
- In the event of a serious operating problem, stop using the unit immediately.
- Never try to repair this product. Repairs carried out by unskilled people can lead to damage or malfunction. Please contact the nearest authorized technical assistance center.
- Never connect this product to a dimmer pack.
- Make sure the power cord is not crimped or damaged.
- Never disconnect the power cord by pulling or tugging on the cord.
- Never carry a fixture from the power cord or any moving part. Always use the hanging/mounting bracket or the handles.
- Always avoid direct eye exposure to the light source when this fixture is on.

2. INTRODUCTION

Product Overview

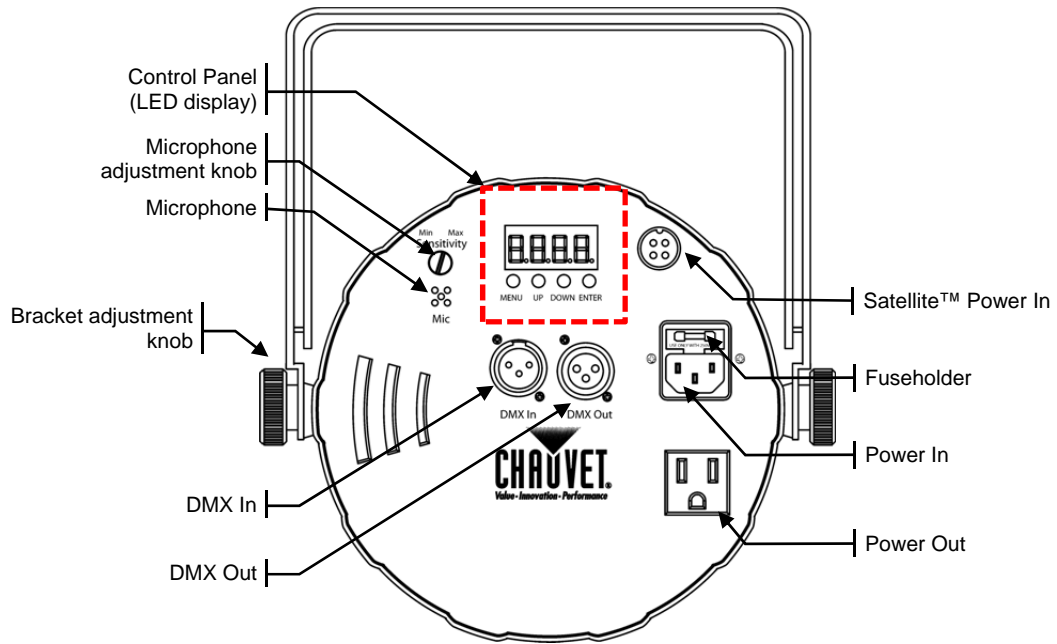

3. SETUP

AC Power

This product has an auto-ranging power supply and it can work with an input voltage range of 100~240 VAC, 50/60 Hz.

To determine the power requirements for a particular fixture, see the label affixed to the back plate of the fixture or refer to the fixture's specifications chart. A fixture's listed current rating indicates its average current draw under normal conditions.



Always connect this product to a protected circuit (circuit breaker or fuse), making sure that it has an appropriate electrical ground to avoid the risk of electrocution or fire.



Never connect this product to a rheostat (variable resistor) or dimmer circuit, even if the rheostat or dimmer channel serves only as a 0 to 100% switch.

Power Linking

This fixture provides power linking via the Edison outlet located in the back of the unit. Please see the diagram below for further explanation.

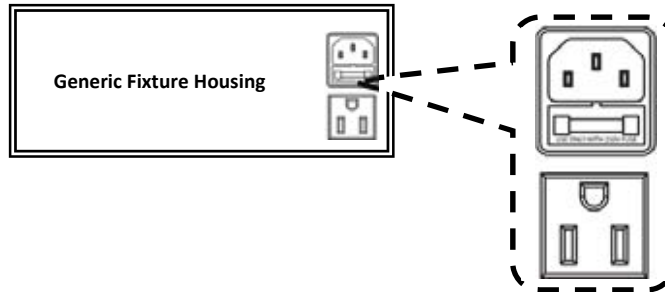

Power Linking Diagram

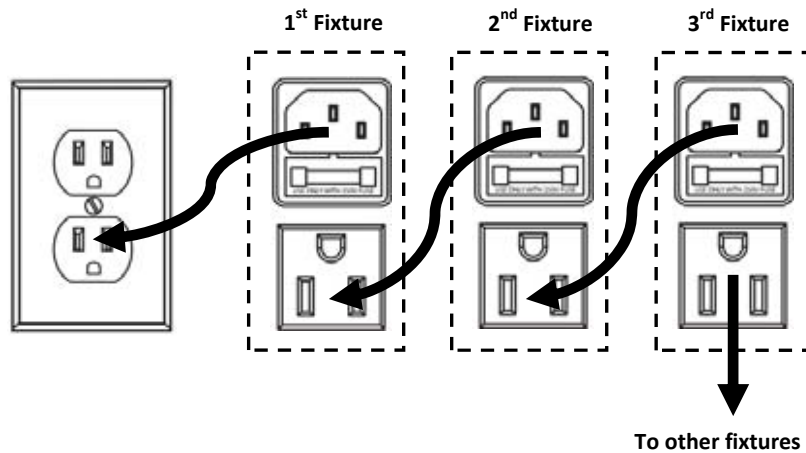

You can power link up to 81 SlimPAR™ 56 units on 120 VAC or up to 143 SlimPAR™ 56 units on 230 VAC.



The power linking diagram shown above corresponds to the North American version of this product ONLY! If using this product in other markets, you must consult with the local CHAUVET® distributor as power linking connectors and requirements may differ in your country or region.

Mounting

Orientation

The SlimPAR™ 56 may be mounted in any position, provided there is adequate room for ventilation.

Rigging

Be sure that the structure onto which you are mounting this product can support its weight. Please see the "Technical Specifications" section of this manual for weight information.

Mount the fixture securely. You can do this with a screw, a nut, and a bolt. You could also use a mounting clamp if rigging this product onto a truss. The bracket has a hole that is 13 mm in diameter, which is appropriate for this purpose.

When mounting this product overhead, always use a safety cable.

Always consider ease of access to the unit for maintenance and programming purposes before deciding on a location for this product

When power linking multiple fixtures, always consider the length of the power linking cable and mount the fixtures close enough from each other to accommodate for this.

The bracket knobs allow for directional adjustment when aiming the fixture to the desired angle. Do not use tools to loose or tighten the bracket knobs. Doing otherwise could damage the knobs.

Mounting Diagram

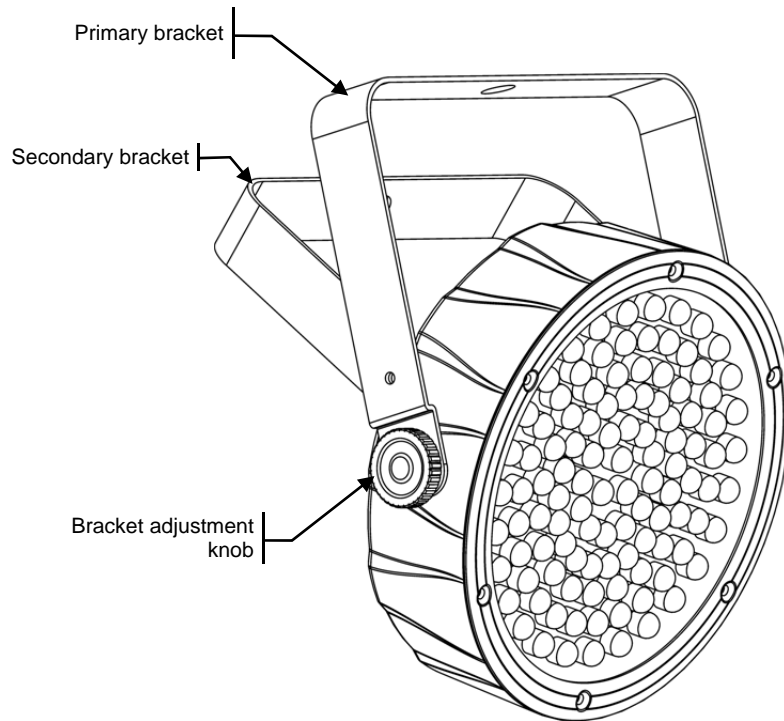

4. OPERATION

Control Panel Operation

To access the control panel functions, use the four buttons located underneath the display.

Button	Function
<MENU>	Press it to find an operation mode or to back out of the current menu option
<UP>	Use it to scroll up the list of options or to find a higher value
<DOWN>	Use it to scroll down the list of options or to find a lower value
<ENTER>	Use it to activate a menu option or a selected value

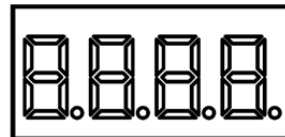

Menu Map

Mode	Programming Steps		Description
<i>P--</i>	<i>P1</i>		7 color program (switching)
	<i>P2</i>		7 color program (fading)
	<i>P3</i>		3 color program (switching)
	<i>P4</i>		3 color program (fading)
	<i>P5</i>		7 color program (sound-active)
	<i>P6</i>		3 color program (sound-active)
<i>3-CH</i>	<i>d001~512</i>		3-channel DMX mode (RGB)
<i>7-CH</i>	<i>d001~512</i>		7-channel DMX mode
<i>C--</i>	<i>C1</i>	Red	Static
	<i>C2</i>	Green	
	<i>C3</i>	Blue	
	<i>C4</i>	Cyan	
	<i>C5</i>	Magenta	
	<i>C6</i>	Yellow	
	<i>C7</i>	White	
<i>S--</i>	<i>S001~S100</i>		Program speed for P1~P4
<i>U--</i>	<i>r--</i>	Red (r000~100)	Custom Static Colors: Combine red, green, and blue
	<i>g--</i>	Green (g000~100)	
	<i>b--</i>	Blue (b000~100)	

Configuration (DMX)

Setting this product to operate in DMX mode will allow you to control it with a DMX controller.

- 1) Connect this product to a suitable power outlet
- 2) Turn this product on
- 3) Connect a DMX cable from the DMX output of the DMX controller to the DMX input socket of this product.

Starting Address

When selecting a starting DMX address, you must always consider the number of DMX channels assigned to the selected DMX mode. If you choose a starting address that is too high, you could limit the access to some of the channels of the DMX mode in use.

The SlimPAR™ 56 uses up to seven DMX channels in the **7-CH** personality, which defines the highest configurable address to 507.

If you are not familiar with the DMX protocol, you may refer to the “DMX Primer” section in the *“Technical Information”* chapter.

To select the starting address, do the following:

- 1) Press **<MENU>** repeatedly until **3-CH** or **7-CH** shows on the display.
- 2) Press **<ENTER>**.
- 3) Use **<UP>** or **<DOWN>** to select the starting address: **d001~d507**.
- 4) Press **<ENTER>**.

Configuration (Standalone)

Sound Active Mode

To enable the Sound Active mode, do the following:

- 1) Connect this product to a suitable power outlet
- 2) Turn this product on
- 3) Press **<MENU>** repeatedly until **P--** shows on the display.
- 4) Press **<ENTER>**.
- 5) Use **<UP>** or **<DOWN>** to select **P5** or **P6** shows on the display.
- 6) Press **<ENTER>**.
- 7) Turn the music on and adjust the microphone sensitivity knob until the fixture starts reacting to the beat of the music.



The fixture will only respond to the low frequencies of the music (bass and drums).

Automatic Mode

To enable the Automatic Mode, follow the instructions below:

- 1) Connect this product to a suitable power outlet
- 2) Turn this product on
- 3) Press **<MENU>** repeatedly until **P--** shows on the display.
- 4) Press **<ENTER>**.
- 5) Use **<UP>** or **<DOWN>** to select **P1~P4** shows on the display.
- 6) Press **<ENTER>**.
- 7) Press **<MENU>** repeatedly until **S--** shows on the display.
- 8) Use **<UP>** or **<DOWN>** to adjust the speed of the program: **S001~100**.
- 9) Press **<ENTER>**.



Never connect a fixture that is operating in Static, Automatic, Custom Static, or Sound Active mode to a DMX string that is being controlled by a DMX controller because the signals from the fixture may interfere with the signals from the controller.

Static Mode

To enable the Static mode, do the following:

- 1) Connect this product to a suitable power outlet
- 2) Turn this product on
- 3) Press <MENU> repeatedly until **C--** shows on the display.
- 4) Press <ENTER>.
- 5) Use <UP> or <DOWN> to select the preset color: **C1~C7**.
- 6) Press <ENTER>.

Custom Static Colors

To enable the Custom Static Colors mode, do the following:

- 1) Connect this product to a suitable power outlet
- 2) Turn this product on
- 3) Press <MENU> repeatedly until **U--** shows on the display.
- 4) Press <ENTER>.
- 5) Use <UP> or <DOWN> to select the desired color: red (**r--**), green (**g--**), or blue (**b--**).
- 6) Press <ENTER>.
- 7) Use <UP> or <DOWN> to select the desired color value: **000~100**. Selecting 000 will turn the color off.
- 8) Press <ENTER> to continue to the next color.
- 9) Repeat steps 5 ~ 7 until you create your desired color.
- 10) Press <ENTER> to save the color.



Never connect a fixture that is operating in Static, Automatic, Custom Static, or Sound Active mode to a DMX string that is being controlled by a DMX controller because the signals from the fixture may interfere with the signals from the controller.

Master/Slave Mode

This mode allows a single SlimPAR™ 56 unit (the “master”) to control the actions of one or more SlimPAR™ 56 units (the “slaves”) without the need of a DMX controller. The master unit will be set to operate in either Automatic or Sound Active mode, while the slave units will be set to operate in Slave Mode. Once set and connected, the slave units will operate in unison with the master unit.

Configure the units as indicated below.

Slave units:

- 1) Press <MENU> repeatedly until **3-CH** or **7-CH** shows on the display.
- 2) Press <ENTER> to accept.
- 3) Use <UP> or <DOWN> to select the starting address to: **d001**.
- 4) Press <ENTER>.
- 5) Connect the DMX input of the first slave unit to the DMX output of the master unit.
- 6) Connect the DMX input of the subsequent slave units to the DMX output of the previous slave unit.
- 7) Finish setting and connecting all the slave units.

Master unit:

- 1) Set the master unit to operate in either Automatic or Sound mode, as previously indicated.
- 2) Make the master unit the first unit in the DMX daisy chain.



- **Wait until all the slave units are configured and connected before connecting the master unit to the DMX daisy chain.**
- **Never connect a DMX controller to a DMX string configured for Master/Slave operation because it may interfere with the signals from the master unit.**



Do not connect more than 31 slave units to the master unit.

DMX Channel Assignments and Values

7-CH Mode

Channel	Function	Value	Setting
1	Red	000 ⇄ 255	0~100%
2	Green	000 ⇄ 255	0~100%
3	Blue	000 ⇄ 255	0~100%
4	Color Macros (overrides CH.1~3)	000 ⇄ 015 016 ⇄ 255	No function Color Macros
5	Speed (when CH.6 is between 032~223)	000 ⇄ 255	0~100%
	Strobe	000 ⇄ 015 016 ⇄ 255	No function Slow ~ fast
6	Mode	000 ⇄ 031 032 ⇄ 063 064 ⇄ 095 096 ⇄ 127 128 ⇄ 159 160 ⇄ 191 192 ⇄ 223 224 ⇄ 255	RGB mode Pulse effect 0%~100% Pulse effect 100%~0% Pulse effect 100%~0%~100% Auto fade transition Auto snap transition (3 colors) Auto snap transition (7 colors) Sound triggering mode
7	Dimmer	000 ⇄ 255	0~100%

3-CH Mode

Channel	Function	Value	Setting
1	Red	000 ⇄ 255	0~100%
2	Green	000 ⇄ 255	0~100%
3	Blue	000 ⇄ 255	0~100%

5. TECHNICAL INFORMATION

General Maintenance

Dust build up reduces light output performance and can cause overheating. This can lead to reduction of the light source's life and mechanical wear. To maintain optimum performance and minimize wear, you should clean your lighting fixtures at least twice a month. However, be aware that usage and environmental conditions could be contributing factors to increase the cleaning frequency.

To clean a lighting fixture, follow the instructions below:

- Unplug the fixture from power.
- Wait until the fixture is cold.
- Use a vacuum (or dry compressed air) and a soft brush to remove dust collected on the external vents and reachable internal components.
- Clean all external optics and glass surfaces with a mild solution of glass cleaner or isopropyl alcohol, and a soft, lint free cotton cloth or a lens cleaning tissue.
- Apply the solution directly to the cloth or tissue and drag any dirt or grime to the outside of the lens.
- Gently polish the external glass surfaces until they are free of haze and lint.
- When cleaning units with a movable mirror, you should keep the contact with the mirror surface to a minimum to avoid scratching or damaging it.



Always dry the external optics and glass surfaces carefully after cleaning them.



If the fixture has one or more cooling fans, refrain from spinning them using compressed air.

General Troubleshooting

Symptom	Possible Cause	Possible Action
Circuit breaker or fuse keeps blowing	<ul style="list-style-type: none"> Excessive load on the circuit 	<ul style="list-style-type: none"> Make sure that the total load does not exceed 80% of the breaker or fuse nominal current
	<ul style="list-style-type: none"> Short circuit along the power lines 	<ul style="list-style-type: none"> Check the power lines and power cords
Product does not power up	<ul style="list-style-type: none"> No energy on power outlet 	<ul style="list-style-type: none"> Check power outlet Change to another outlet
	<ul style="list-style-type: none"> Loose or damaged power cord 	<ul style="list-style-type: none"> Check the power cord
	<ul style="list-style-type: none"> Blown fuse 	<ul style="list-style-type: none"> Replace blown fuse with a good one of the same type and rating
Fixture does not respond to DMX	<ul style="list-style-type: none"> Internal problem 	<ul style="list-style-type: none"> Send product for repair
	<ul style="list-style-type: none"> Wrong starting address on the fixture 	<ul style="list-style-type: none"> Set the correct starting address on the fixture Use the right fader(s) on the controller
	<ul style="list-style-type: none"> Wrong DMX personality on the fixture 	<ul style="list-style-type: none"> Set the correct DMX personality on fixture Assign the faders accordingly
	<ul style="list-style-type: none"> Wrong polarity setting on the DMX controller 	<ul style="list-style-type: none"> Change the signal polarity on the controller
	<ul style="list-style-type: none"> Loose or damaged DMX cable 	<ul style="list-style-type: none"> Check the DMX cable before the faulty unit
Intermittent DMX Problems	<ul style="list-style-type: none"> Internal problem 	<ul style="list-style-type: none"> Send product for repair
	<ul style="list-style-type: none"> Signal cables are not DMX compatible 	<ul style="list-style-type: none"> Replace non DMX cables with true DMX cables
	<ul style="list-style-type: none"> Interference with AC or radio signals 	<ul style="list-style-type: none"> Keep DMX cables away from AC wires or radio equipment
	<ul style="list-style-type: none"> DMX cable too long 	<ul style="list-style-type: none"> Install an optically coupled DMX amplifier right before the fixture with intermittent problems
	<ul style="list-style-type: none"> Too many fixtures connected 	<ul style="list-style-type: none"> Install an optically coupled DMX amplifier after unit #32
	<ul style="list-style-type: none"> Terminator not connected 	<ul style="list-style-type: none"> Install a terminator, as indicated in "DMX Primer".



If you still experience problems after trying the above solutions, contact CHAUVET® Technical Support.

Returns Procedure

The user must send the merchandise prepaid, in the original box, and with its original packing and accessories. CHAUVET® will not issue call tags.

Call CHAUVET® and request a Return Merchandise Authorization Number (RMA #) before shipping the fixture. Be prepared to provide the model number, serial number, and a brief description of the cause for the return.

The user must clearly label the package with a Return Merchandise Authorization Number (RMA #). CHAUVET® will refuse any product returned without an RMA #.



DO NOT write the RMA # directly on the box. Instead, write it on a properly affixed label.

Once you have received the RMA #, please include the following information on a piece of paper inside the box:

- Your name
- Your address
- Your phone number
- The RMA #
- A brief description of the problem

Be sure to pack the fixture properly. Any shipping damage resulting from inadequate packaging will be the customer's responsibility. As a suggestion, proper UPS packing or double-boxing is always a safe method to use.



CHAUVET® reserves the right to use its own discretion to repair or replace returned product(s).

Claims

The carrier is responsible for any damage incurred during shipping to this product or any part that shipped with it. Therefore, if the received merchandise appears to have damages caused during shipping, the customer must submit the damage report and any related claims with the carrier, not CHAUVET®. The customer must submit the report upon reception of the damaged merchandise. Failure to do so in a timely manner may invalidate the customer's claim with the carrier.

For other issues such as missing components or parts, damage not related to shipping, or concealed damage, the customer must make claims to CHAUVET® within seven (7) days of receiving the merchandise.

Contact Information

World Headquarters

General Information

Address:

CHAUVET®
5200 NW 108th Avenue
Sunrise, FL 33351
(954) 929-1115
(954) 929-5560
(800) 762-1084

Voice:

Fax:

Toll free:

Technical Support

Voice:

Fax:

(954) 929-1115 (Press 4)
(954) 756-8015

World Wide Web www.chauvetlighting.com

United Kingdom & Ireland

General Information

Address:

CHAUVET® Europe Ltd.
Unit 1C
Brookhill Road Industrial Estate
Pinxton, Nottingham, UK
NG16 6NT
+44 (0)1773 511115
+44 (0)1773 511110
uktech@chauvetlighting.com

Voice:

Fax:

Email:

World Wide Web www.chauvetlighting.co.uk

DMX Primer

The USITT DMX512-A data transmission protocol (DMX, from now on) is based on the EIA-485 standard and it has 512 channels. Any DMX compatible fixture will require one or more consecutive DMX channels to operate. Because of the many different types of DMX compatible fixtures, they may vary in the total number of channels they require.

In addition, there can only be one DMX controller operating on the same DMX connection at any given time. Otherwise, the signals from one controller could interfere with the signals from the other controller, thus causing erratic fixture operation.

Starting Address

Once the user has determined how many channels each fixture requires, he or she must assign the corresponding channels on the DMX controller for it to send the control signals to the intended fixture. In the DMX system, each fixture is identified by its starting address. The starting address is the number of the DMX channel assigned to the first control channel on the fixture.

For instance, a user has two DMX compatible fixtures. One of them has four channels and the other has six channels. The user may configure the starting address of the 4-channel fixture to "001". This will assign the channels 001 through 004 on the DMX controller to this fixture. To identify the six-channel fixture, the user should assign to it a starting address of "005" or higher. For a starting address of "005", the DMX controller would use channels 005 to 010 to control the second fixture.

Choosing a starting address should be planned carefully. The first requirement is to avoid channel overlapping. Doing otherwise may result in erratic operation of the affected fixtures. The second requirement is to avoid leaving unassigned channels because this creates unused faders on the DMX controller, which may be critical for small DMX controllers with only a few available faders.

It is possible to control multiple fixtures of the same type by assigning each one of them the same starting address. In this case, all the fixtures would respond in unison (synchronized) to the signals from the DMX controller.

Fixture Linking (Daisy Chain)

DMX compatible fixtures receive the control signals from the DMX controller through the DMX cables. Each fixture has a DMX In and a DMX Out connector. A DMX cable runs from the DMX output of the DMX controller to the DMX input of the first fixture. Another DMX cable runs from the DMX output of the first fixture to the DMX input of the second fixture, and so on. The DMX signals from the controller reach all the fixtures linked with the DMX cable. This type of sequential connection is known as "daisy chain".

The order in which the fixtures connect to the DMX controller is irrelevant because all fixtures receive the same DMX signals and they only respond to them based on their individual starting addresses. However, you should consider a connection sequence that provides the shortest and most direct cable runs between fixtures.

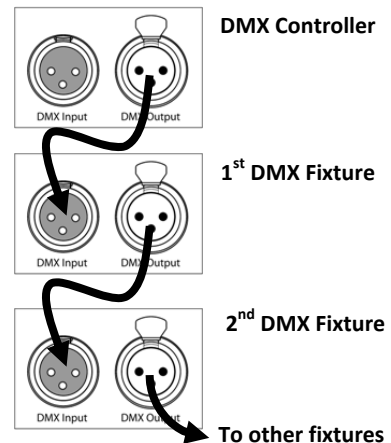

To ensure the integrity of the DMX signal, you should follow the recommendations of the EIA-485 standard regarding the number of fixtures that can be connected to the DMX daisy chain and the total length of the DMX cable as follows:

- The maximum recommended cable length is 500 m (1,640 feet).
- The maximum recommended number of fixtures on the same daisy chain is 32.



Connecting more than 32 fixtures on one daisy chain without the use of a DMX optically-isolated splitter may result in deterioration of the digital DMX signal.

DMX Cabling

The DMX protocol requires using special data cables to accommodate for the high speed digital signals it uses. Despite their apparent similarities, data cables are electrically different from standard microphone cable because they can carry high frequency digital signals and are less prone to electromagnetic interference. You can purchase CHAUVET® certified DMX cables directly from a dealer/distributor or make your own DMX cable.

If you choose to make your own DMX cable, you must use a data-grade cable such as the Belden 9841, which has the following electrical characteristics:

Type:	shielded, 2-conductor twisted pair
Maximum capacitance between conductors:	30 pF/ft
Maximum capacitance between conductor and shield:	55 pF/ft
Maximum resistance:	20 ohms/1000 ft
Nominal impedance:	100–140 ohms

DMX Connectors

Each DMX cable must have a male XLR connector on one end and a female XLR connector on the other end. The DMX protocol indicates that the XLR connectors must have five pins. However, most lighting fixtures use the 3-pin XLR connector. The pin out of the 3-pin XLR connectors in a DMX cable is as follows:

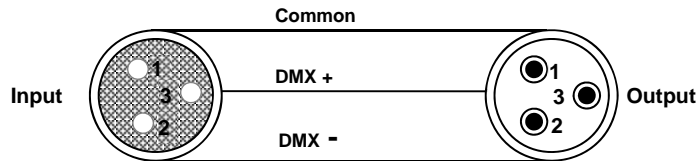

As it is common with digital signal links, the DMX daisy chain uses a terminator to reduce signal transmission problems. This terminator consists of a 120 Ω, ¼ W resistor connected to pins 2 and 3 of a male 3-pin XLR plug as shown below. This plug connects to the DMX Out socket of the last DMX fixture in the daisy chain.

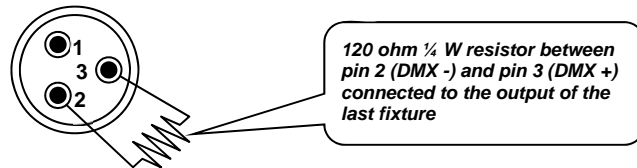

Do not allow the common wire of the DMX cable to come in contact with the fixture's chassis ground. This could cause a ground loop, which could make your fixture perform erratically. Test all DMX cables with an ohmmeter to verify the correct polarity of the wires and to make sure that they are not shorted to the shield or to each other.

3- to 5-Pin Conversion Table

The table below illustrates the pin out for the 3- and 5-pin XLR connectors, which you could use to make a 3- to 5-pin adapter.

Wire Usage	3-Pin XLR Connector	5-Pin XLR Connector
Shield (Common)	Pin 1	Pin 1
Data –	Pin 2	Pin 2
Data +	Pin 3	Pin 3
Not assigned	---	Pin 4
	---	Pin 5

6. TECHNICAL SPECIFICATIONS

Dimensions and Weight

Length	Width	Height	Weight
9.5 in (241 mm)	8.8 in (224 mm)	2.2 in (56 mm)	2.7 lbs (1.2 kg)

Note: Dimensions in inches rounded to the nearest decimal digit.

Power

Power Supply Type	Range	Voltage Selection
Switching (internal)	100–240 V, 50/60 Hz	Auto-ranging
Parameter	120 V, 60 Hz	230 V, 50 Hz
Consumption	20 W (0.17 A)	22 W (0.10 A)
Power I/O	Input	Output
Connectors	IEC	Edison
Cord plug	Edison	N/A

Fuse

Light Source

Type	Power	Lifespan
LED	1/4 W	100,000 hours
Color	Quantity	Current
Red	36	20 mA
Green	36	20 mA
Blue	36	20 mA

Photo Optic

Parameter	Value
Illuminance @ 1 m	2,300 lux
Illuminance @ 2 m	838 lux
Beam angle	14°
Field angle	23°

Thermal

Maximum External Temp.	Cooling System
104° F (40° C)	Convection

DMX

I/O Connectors	Connector Type	Channel Range
3-pin XLR	Sockets	3, 7

Ordering

SlimPAR™ 56 SLIMPAR56
