



Precision detection fiber sensor heads

Highest precision in design and manufacturing of the fibers and focal lenses ensure highest beam and spot accuracy allowing the detection of smallest objects and height differences of less than 100 µm.

- Coaxial fibers with focal lenses for spot diameters of 100 µm
- Through-beam models with highly focused beam and precise optical axis alignment
- Limited reflective models for height difference detection of less than 100 µm

Ordering information

Sensor type	Preferred usage	Size	Key feature	Sensing distance (in mm) ^{*1}	Order code	
	Precise thin object detection / accurate positioning	dia 3 mm	- High precision optical axis adjustment - Very focused beam	1900	E32-T22S	
				890	E32-A03 2M	
		dia 2 mm		340	E32-A04 2M	
	Very small object detection	M6	- 90° cable exit - Hexagonal back	300	E32-CC200 2M ^{*2}	
		M3		Spot dia 0.5 mm	20	E32-EC31 2M
				Spot dia 0.2 mm	17	E32-EC41 1M + E39-F3B
				Spot dia 0.1 mm	7	E32-EC41 1M + E39-F3A-5
		dia 3 mm		-	150	E32-D32L
		dia 2 mm		-	75	E32-D32 2M ^{*2}
		M6		-	170	E32-C11N 2M
		M3		-	25	E32-C31N 2M
		dia 2 mm		Small spot	8-25 m adjustable	E32-EC31 2M + E39-EF51
				Spot dia 0.7 to 3 mm	10 to 30 mm	E32-D32 2M + E39-F16
	Spot dia 0.3 to 1.6 mm		E32-C42 1M + E39-F16			
	Spot dia 0.5 to 1 mm	6-15 mm adjustable	E32-D32 2M + E39-F3A			
	Spot dia 0.1 to 0.6 mm	6-15 mm adjustable	E32-C42 1M + E39-F3A			
	Precision height difference detection / flat surface detection	23x20x9 mm	-	35	E32-A09 2M	
		16x18x4 mm	-	7.2	E32-L25L ^{*2}	
		20x20x5 mm	-	3.3	E32-L25	
		18x20x4 mm	Precise spot e.g. for detection of a flat / reflective surface	4	E32-L24L ^{*2}	
		34x25x8 mm	High precision (detection accuracy 100 µm)	2.4	E32-EL24-1 2M	
	Object detection in front of background	20.5x14x3.8 mm	Wide beam e.g. for object detection on a flat surface	15	E32-L16-N 2M	

^{*1} Sensing distance measured with E3X-DA-SE-S family. Longer sensing distance up to 80% can be achieved with E3X-DA-S.

^{*2} A high flex cable version is available. Add 'R' to the order code, e.g. E32-CC200R

Specifications

Item	Through-beam			Diffuse reflective (coaxial)			Limited reflective				
	E32-T2S	E32-A03	E32-A04	E32-C11N E32-C31N	E32-CC200	E32-C42 E32-D32/-D32L E32-EC31/-EC41	E32-EL24-1	E32-L24L E32-L25L	E32-L25	E32-L16	E32-A09
Permissible bending radius	R10	R1	R10	R4	R25		R10		R25		
Cut to length	Yes										
Material Head	Brass-nickel plated		Stainless steel	Brass-nickel plated		Brass nickel plated	Brass-nickel plated and aluminium	Polycarbonate	ABS		Aluminium
Fiber	PMMA										
Sheath	PVC coating	Polyethylene coating		PVC coating	PVC, polyethylene and polyolefin coating		Polyethylene coating				
Degree of protection	IEC 60529 IP67		IEC 60529 IP50		IEC 60529 IP67			IEC 60529 IP50		IEC 60529 IP40	

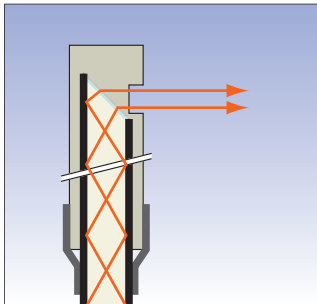

Focused and high precision beam alignment during manufacturing. Models available with typical deviation of 0.1° for very precise detections

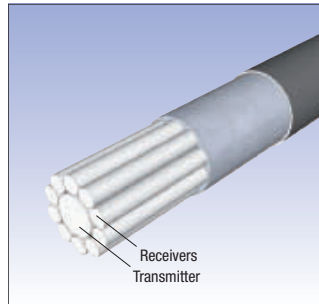

Coaxial fibers provide an enhanced positioning and detection accuracy and allow the easy adjustment of the focal point using adjustable focal lenses

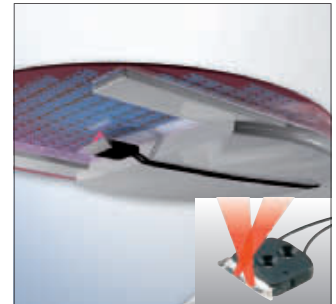
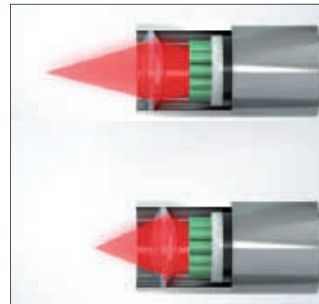

Limited reflective fibers utilize the total reflection on shiny surfaces to detect height differences or objects at a pre-defined distance.









Special application fiber sensor heads

For a wide range of special applications, the task optimised fiber heads provide best fitting sensing performance and adaption to environmental requirements.

- Detection of special objects (liquids, labels on foils, etc.)
- Fiber heads ideal for colour mark detection
- Fiber heads optimised for special tasks (wafer mapping, flat glass, etc.)

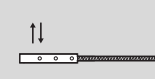
Ordering information

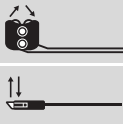
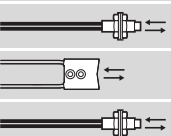
Sensor type		Size	Sensing distance (in mm) ^{*1}	Comment	Order code
	Fork shape	36x24x8 mm	10	–	E32-G14
	Wafer mapping	dia 3	1900	–	E32-T22S
		dia 3	1300	–	E32-T24S
		dia 3	890	–	E32-A03 2M
		dia 2	340	–	E32-A04 2M
	Liquid level sensor	dia 6	liquid contact	Liquid level contact	E32-D82F1 4M
		15x23.5x5 mm	tube contact	Liquid level detection through transparent tube or container	E32-D36T 2M
	Glass detection	21x16.5x4 mm	8 mm	Metal housing	E32-A10 2M
		20.5x14x3.8 mm	15 mm	Plastic housing	E32-L16-N 2M
	Glass detection in hot environment	25x18x5 mm	5 mm	Heat resistant up to 300°C	E32-L64 2M
		36x18x5.5 mm	18 mm		E32-L66 2M
	Glass detection in wet processes	38.5x39x17.5 mm	8 to 20 (recommended: 11 mm)	- Heat resistant up to 85°C - Recommended usage with 'tough mode' of E3X-DA-S	E32-L11FS 2M
	Label detection	20x20x5 mm	7.2	–	E32-L25L
		18x20x4 mm	4	–	E32-L24L
		34x25x8 mm	2.4	Very precise spot (detection accuracy 100 µm)	E32-EL24-1 2M
	Colour/print mark detection ^{*2}	M6	300	Recommended for standard colour and colour mark detection	E32-CC200 2M
		29x25.5x11.2	55	Recommended for challenging colour and colour mark detection	E32-L15 2M
		23x20x9 mm	35		E32-A09 2M
		M3	20	Recommended for very precise colour mark detection	E32-EC31 2M

^{*1} Sensing distance measured with E3X-DA-SE-S family. Longer sensing distance up to 80% can be achieved with E3X-DA-S.

^{*2} With amplifier E3X-DAC-S

Specifications

Item	E32-D82F1 E32-L11FS	E32-G14	E32-A09	E32-A10	E32-L15	E32-L16-N	E32-CC200	E32-EC31	E32-L66	E32-L64
Permissible bending radius	R40	R25								
Cut to length	Yes								No	
Material Head	PFA	ABS	Aluminium	ABS	PAR	PVC	Brass-nickel plated	Stainless steel		
	Fiber	PMMA							Glass	
	Sheath	Polyethylene coating					PVC, polyethylene and polyolefin coating		Stainless steel spiral coating	
Degree of protection	IEC 60529 IP67		IEC 60529 IP40	IEC 60529 IP30	IEC 60529 IP50	IEC 60529 IP40	IEC 60529 IP67		IEC 60529 IP40	IEC 60529 IP50

Item	E32-EL24-1	E32-T24S	E32-L24L E32-L25L	E32-A04	E32-D36T	E32-A03	E32-T22S
Permissible bending radius	R10				R4	R1	
Cut to length	Yes						
Material Head	Brass-nickel plated and aluminium	Stainless steel	Brass-nickel plated	Stainless steel	ABS	Brass-nickel plated	
	Fiber	PMMA					
	Sheath	Polyethylene coating	PVC coating	Polyethylene coating		PVC coating	Polyethylene coating
Degree of protection	IEC 60529 IP67		IEC 60529 IP50		IEC 60529 IP67	IEC 60529 IP50	IEC 60529 IP67



In combination with the colour/mark detection amplifier E3X-DAC-S, the recommended fibers for colour/mark detection allow the detection of standard and challenging marks even for complex designs or with small contrast.

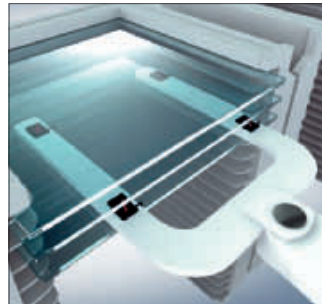

The limited reflective fiber heads for glass detection provide a stable detection of flat glass in standard, hot or wet environment. The shapes and materials are optimized to provide the best value - performance ratio depending on the requirements.



For the detection of very small height differences like labels on foils in applications where space is crucial, the small sized limited reflective sensors provide accurate detection up to 100µm resolution.

Product dimensions

E32-A03

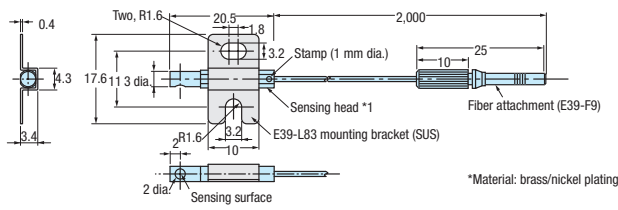

E32-A03-1

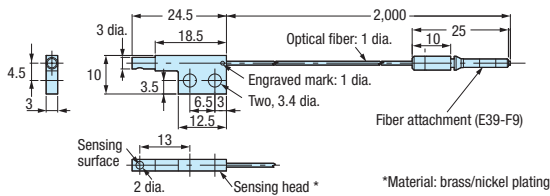

E32-A04

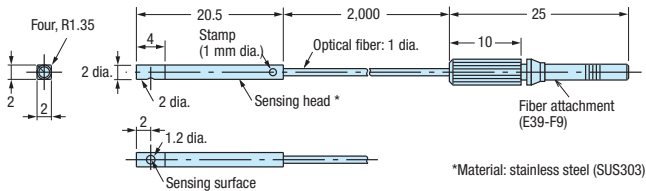

E32-A04-1

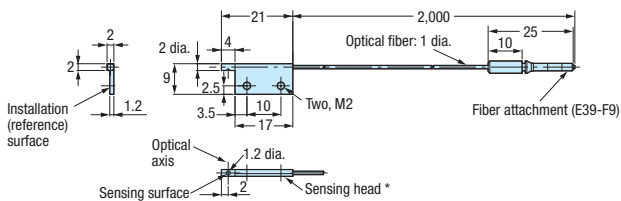

E32-A09, E32-A09H

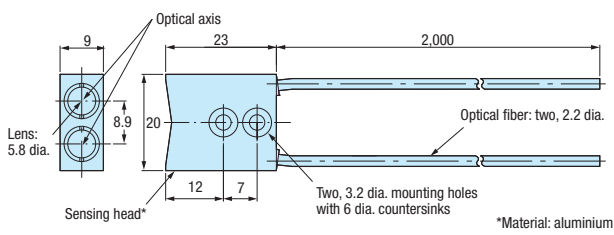

E32-A09H2

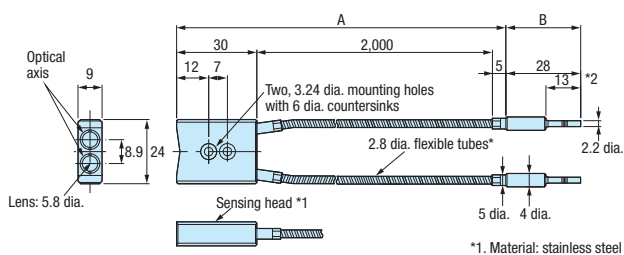

E32-A10

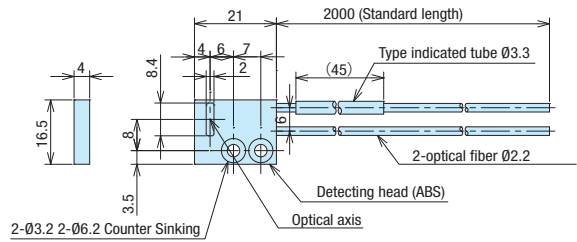

E32-C11N

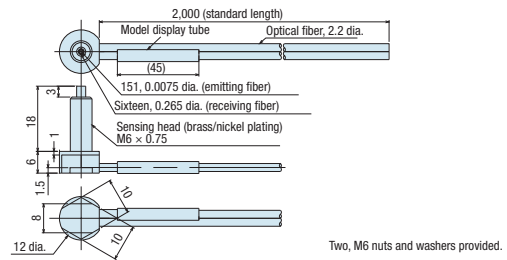

E32-C31N

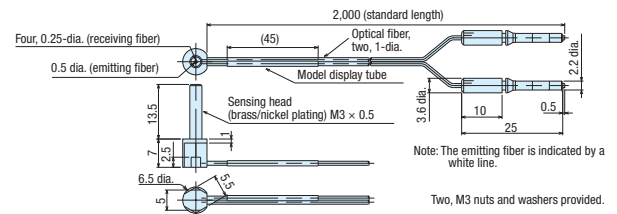

E32-C42

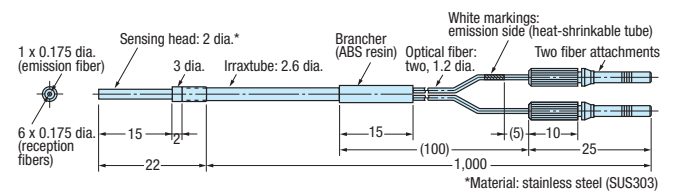

E32-CC200

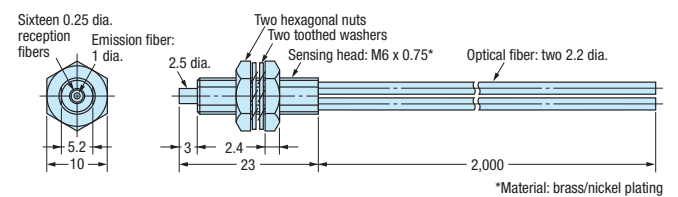

E32-D11, E32-D11U

