

**Austin MegaLynx™: Non-Isolated DC-DC Power Modules:
4.5 – 5.5Vdc input; 0.8 to 3.63Vdc output; 30A Output Current
6.0 – 14Vdc input; 0.8dc to 5.5Vdc output; 25A Output Current**

RoHS Compliant

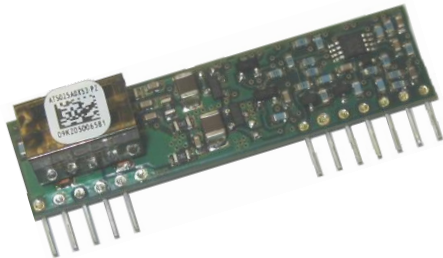

Applications

- Distributed power architectures
- Intermediate bus voltage applications
- Telecommunications equipment
- Servers and storage applications
- Networking equipment

Description

The Austin MegaLynx series SIP power modules are non-isolated DC-DC converters in an industry standard package that can deliver up to 30A of output current with a full load efficiency of 92% at 3.3Vdc output voltage ($V_{IN} = 12Vdc$). The ATH series of modules operate off an input voltage from 4.5 to 5.5Vdc and provide an output voltage that is programmable from 0.8 to 3.63Vdc, while the ATS series of modules have an input voltage range from 6 to 14V and provide a programmable output voltage ranging from 0.8 to 5.5Vdc. Both series have a sequencing feature that enables designers to implement various types of output voltage sequencing when powering multiple modules on the board. Additional features include remote On/Off, adjustable output voltage, remote sense, over current, over temperature protection and active current sharing between modules.

Features

- Compliant to RoHS EU Directive 2002/95/EC (-Z versions)
- Compliant to ROHS EU Directive 2002/95/EC with lead solder exemption (non-Z versions)
- Delivers up to 30A of output current
- High efficiency – 93% 3.3V full load ($V_{IN}=12Vdc$)
- Available in two input voltage ranges
 - ATH: 4.5 to 5.5Vdc
 - ATS: 6.0 to 14Vdc
- Output voltage programmable from
 - ATH: 0.8 to 3.63Vdc
 - ATS: 0.8 to 5.5Vdc
- Small size and low profile:
 - 50.8 mm x 12.7 mm x 14.0 mm
 - 2.00 in. x 0.50 in. x 0.55 in.
- Monotonic start-up into pre-biased output
- Output voltage sequencing (EZ-SEQUENCE™)
- Remote On/Off
- Remote Sense
- Over current and Over temperature protection
- Parallel operation with active current sharing
- Wide operating temperature range (-40°C to 85°C)
- UL* 60950 Recognized, CSA† C22.2 No. 60950-00 Certified, and VDE‡ 0805 (EN60950-1 3rd edition) Licensed
- ISO** 9001 and ISO 14001 certified manufacturing facilities

* UL is a registered trademark of Underwriters Laboratories, Inc.

† CSA is a registered trademark of Canadian Standards Association.

‡ VDE is a trademark of Verband Deutscher Elektrotechniker e.V.

** ISO is a registered trademark of the International Organization of Standards

Absolute Maximum Ratings

Stresses in excess of the absolute maximum ratings can cause permanent damage to the device. These are absolute stress ratings only, functional operation of the device is not implied at these or any other conditions in excess of those given in the operations sections of the data sheet. Exposure to absolute maximum ratings for extended periods can adversely affect the device reliability.

Parameter	Device	Symbol	Min	Max	Unit
Input Voltage Continuous	All	V_{IN}	-0.3	15	Vdc
Sequencing pin voltage	All	V_{SEQ}	-0.3	15	Vdc
Operating Ambient Temperature (see Thermal Considerations section)	All	T_A	-40	85	°C
Storage Temperature	All	T_{stg}	-55	125	°C

Electrical Specifications

Unless otherwise indicated, specifications apply over all operating input voltage, resistive load, and temperature conditions.

Parameter	Device	Symbol	Min	Typ	Max	Unit
Operating Input Voltage	ATH	V_{IN}	4.5	5.0	5.5	Vdc
	ATS	V_{IN}	6.0	12	14	Vdc
Maximum Input Current ($V_{IN}=V_{IN,min}$, $V_O=V_{O,set}$, $I_O=I_{O,max}$)	ATH	$I_{IN,max}$			27	Adc
	ATS	$I_{IN,max}$			26	Adc
Inrush Transient	All	I^2t			1	A^2s
Input Reflected Ripple Current, peak-to-peak (5Hz to 20MHz, 1 μ H source impedance; $V_{IN}=6.0V$ to 14.0V, $I_O=I_{O,max}$; See Figure 1)	All			100		mAp-p
Input Ripple Rejection (120Hz)	All			50		dB

Electrical Specifications (continued)

Parameter	Device	Symbol	Min	Typ	Max	Unit
Output Voltage Set-point ($V_{IN}=V_{IN,min}$, $I_O=I_{O,max}$, $T_{ref}=25^{\circ}C$)	All	$V_{O,set}$	-1.5	—	+1.5	% $V_{O,set}$
Output Voltage (Over all operating input voltage, resistive load, and temperature conditions until end of life)	All	$V_{O,set}$	-3.0		+3.0	% $V_{O,set}$
Adjustment Range Selected by an external resistor	ATH ATS	V_O V_O	0.8 0.8		3.63 5.5	Vdc Vdc
Output Regulation Line ($V_{IN}=V_{IN,min}$ to $V_{IN,max}$) Load ($I_O=I_{O,min}$ to $I_{O,max}$) Temperature ($T_{ref}=T_{A,min}$ to $T_{A,max}$)	All All All			0.5	0.1 0.4 1	% $V_{O,set}$ % $V_{O,set}$ % $V_{O,set}$
Output Ripple and Noise on nominal output ($V_{IN}=V_{IN,nom}$ and $I_O=I_{O,min}$ to $I_{O,max}$ $C_{OUT} = 0.01\mu F // 0.1\mu F // 10\mu F$ ceramic capacitors) Peak-to-Peak (5Hz to 20MHz bandwidth) Peak-to-Peak (5Hz to 20MHz bandwidth) Peak-to-Peak (5Hz to 20MHz bandwidth)	$V_O \leq 2.5V$ $2.5V < V_O \leq 3.63V$ $V_O > 3.63V$				50 75 100	mV _{pk-pk} mV _{pk-pk} mV _{pk-pk}
External Capacitance ESR ≥ 1 m Ω ESR ≥ 10 m Ω	All All	$C_{O,max}$ $C_{O,max}$	0 0		2,000 10,000	μF μF
Output Current ($V_{IN} = 5Vdc/12Vdc$) Output Current ($V_{IN} = 5Vdc$)	ATH025/ATS025 ATH030	I_o I_o	0 0		25 30	Adc Adc
Output Current Limit Inception (Hiccup Mode)	All	$I_{O,lim}$		120		% $I_{O,max}$
Output Short-Circuit Current ($V_O \leq 250mV$) (Hiccup Mode)	All	$I_{O,s/c}$		20		% $I_{O,max}$
Efficiency $V_{IN}=12Vdc$, $T_A=25^{\circ}C$ $I_O=25A$, $V_O= V_{O,set}$	$V_{O,set} = 0.8dc$ $V_{O,set} = 1.2Vdc$ $V_{O,set} = 1.5Vdc$ $V_{O,set} = 1.8Vdc$ $V_{O,set} = 2.5Vdc$ $V_{O,set} = 3.3Vdc$ $V_{O,set} = 5.0Vdc$	η η η η η η η		82.0 84.0 88.0 89.5 91.0 92.5 94.0		% % % % % % %
Efficiency $V_{IN}=5Vdc$, $T_A=25^{\circ}C$ $I_O=30A$, $V_O= V_{O,set}$	$V_{O,set} = 0.8dc$ $V_{O,set} = 1.2Vdc$ $V_{O,set} = 1.5Vdc$ $V_{O,set} = 1.8Vdc$ $V_{O,set} = 2.5Vdc$ $V_{O,set} = 3.3Vdc$	η η η η η η		84.0 88.5 90.0 91.0 93.0 95.0		% % % % % %
Switching Frequency, Fixed	All	f_{sw}	—	300	—	kHz

Electrical Specifications (continued)

Parameter	Device	Symbol	Min	Typ	Max	Unit
Dynamic Load Response						
($di_O/dt=5A/\mu s$; $V_{IN}=V_{IN, nom}$; $V_O=3.3V$; $T_A=25^\circ C$;) Load Change from $I_O=0\%$ to 50% of $I_{O, max}$; No external output capacitors						
Peak Deviation	ATS	V_{pk}	—	350	—	mV
Settling Time ($V_O<10\%$ peak deviation)	ATS	t_s	—	20	—	μs
($di_O/dt=5A/\mu s$; $V_{IN}=V_{IN, nom}$; $V_O=3.3V$; $T_A=25^\circ C$;) Load Change from $I_O=50\%$ to 0% of $I_{O, max}$; No external output capacitors						
Peak Deviation	ATS	V_{pk}	—	350	—	mV
Settling Time ($V_O<10\%$ peak deviation)	ATS	t_s	—	20	—	μs
($di_O/dt=5A/\mu s$; $V_{IN}=V_{IN, nom}$; $V_O=3.3V$; $T_A=25^\circ C$;) Load Change from $I_O=0\%$ to 50% of $I_{O, max}$; No external output capacitors						
Peak Deviation	ATH	V_{pk}	—	320	—	mV
Settling Time ($V_O<10\%$ peak deviation)	ATH	t_s	—	20	—	μs
($di_O/dt=5A/\mu s$; $V_{IN}=V_{IN, nom}$; $V_O=3.3V$; $T_A=25^\circ C$;) Load Change from $I_O=50\%$ to 0% of $I_{O, max}$; No external output capacitors						
Peak Deviation	ATH	V_{pk}	—	250	—	mV
Settling Time ($V_O<10\%$ peak deviation)	ATH	t_s	—	20	—	μs

General Specifications

Parameter	Min	Typ	Max	Unit
Calculated MTBF ($V_{IN}=V_{IN, nom}$; $I_O=0.8I_{O, max}$; $T_A=40^\circ C$) Telecordia SR 332 Issue 1: Method 1, case 3		3,016,040		Hours
Weight	—	7.4	—	g

Feature Specifications

Unless otherwise indicated, specifications apply over all operating input voltage, resistive load, and temperature conditions. See Feature Descriptions for additional information.

Parameter	Device	Symbol	Min	Typ	Max	Unit
On/Off Signal Interface ($V_{IN}=V_{IN, min}$ to $V_{IN, max}$; open collector or equivalent, Signal referenced to GND)						
Logic High (Module OFF)						
Input High Current	All	I_{IH}	0.5	—	3.3	mA
Input High Voltage	All	V_{IH}	3.0	—	$V_{IN, max}$	V
Logic Low (Module ON)						
Input Low Current	All	I_{IL}	—	—	200	μ A
Input Low Voltage	All	V_{IL}	-0.3	—	1.2	V
Turn-On Delay and Rise Times ($V_{IN}=V_{IN, nom}$, $I_O=I_{O, max}$, V_O to within $\pm 1\%$ of steady state)						
Case 1: On/Off input is enabled and then input power is applied (delay from instant at which $V_{IN} = V_{IN, min}$ until $V_O = 10\%$ of $V_{O, set}$)	All	T_{delay}	—	3		msec
Case 2: Input power is applied for at least one second and then the On/Off input is enabled (delay from instant at which On/Off is enabled until $V_O =$ 10% of $V_{O, set}$)	All	T_{delay}	—	3		msec
Output voltage Rise time (time for V_O to rise from 10% of $V_{O, set}$ to 90% of $V_{O, set}$)	All	T_{rise}	—	4		msec
Output voltage overshoot $I_O = I_{O, max}$; $V_{IN, min} - V_{IN, max}$, $T_A = 25^\circ\text{C}$					3.0	% $V_{O, set}$
Remote Sense Range	All		—	—	0.5	V
Over Temperature Protection (See Thermal Consideration section)	All	T_{ref}	—	125	—	$^\circ\text{C}$
Sequencing Slew rate capability ($V_{IN, min}$ to $V_{IN, max}$; $I_{O, min}$ to $I_{O, max}$ $V_{SEQ} < V_O$)	All	dV_{SEQ}/dt		—	2	V/msec
Sequencing Delay time (Delay from $V_{IN, min}$ to application of voltage on SEQ pin)	All	$T_{SEQ-delay}$	10			msec
Tracking Accuracy						
Power-up (2V/ms)	All	$ V_{SEQ} - V_{O, set} $		100	200	mV
Power-down (1V/ms)		$ V_{SEQ} - V_{O, set} $		200	400	mV
($V_{IN, min}$ to $V_{IN, max}$; $I_{O, min} - I_{O, max}$ $V_{SEQ} < V_{O, set}$)						
Input Undervoltage Lockout						
Turn-on Threshold	ATH			4.3		Vdc
Turn-off Threshold	ATH			3.9		Vdc
Turn-on Threshold	ATS			5.5		Vdc
Turn-off Threshold	ATS			5.0		Vdc
Forced Load Share Accuracy	-P		—	10		% I_O
Number of units in Parallel	-P				5	

Characteristic Curves

The following figures provide typical characteristics for the ATS025A0X (0.8V, 25A) at 25°C.

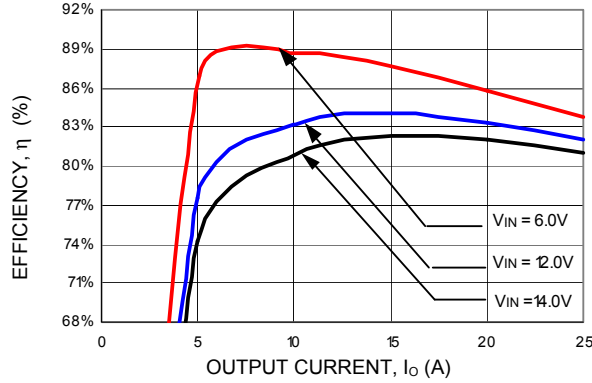

Figure 1. Converter Efficiency versus Output Current.

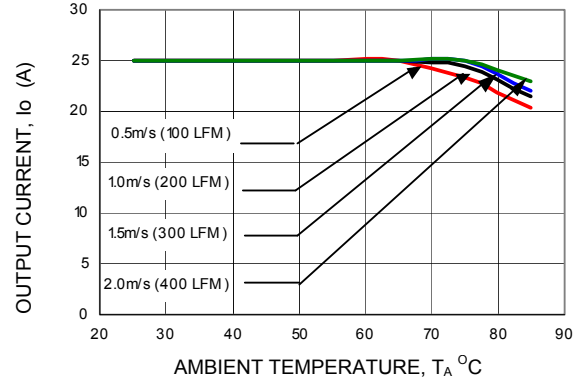

Figure 4. Derating Output Current versus Local Ambient Temperature and Airflow.

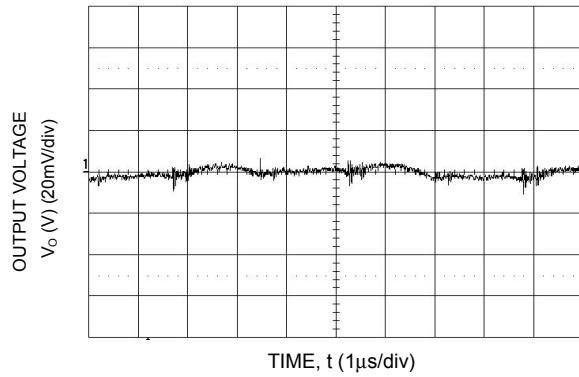

Figure 2. Typical output ripple and noise ($V_{IN} = V_{IN,NOM}$, $I_o = I_{o,max}$).

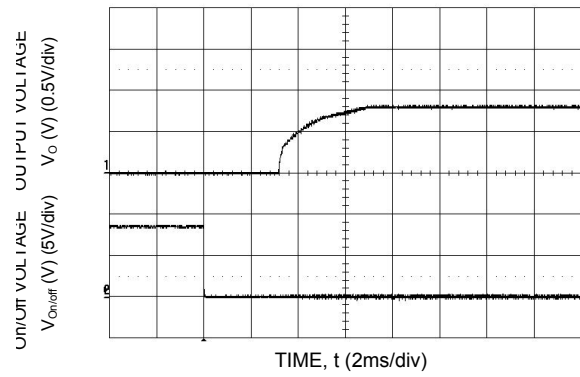

Figure 5. Typical Start-up Using Remote On/Off ($V_{IN} = V_{IN,NOM}$, $I_o = I_{o,max}$).

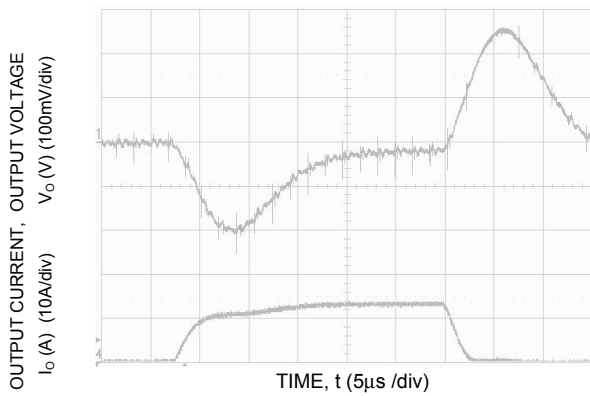

Figure 3. Transient Response to Dynamic Load Change from 0% to 50% to 0% of full load.

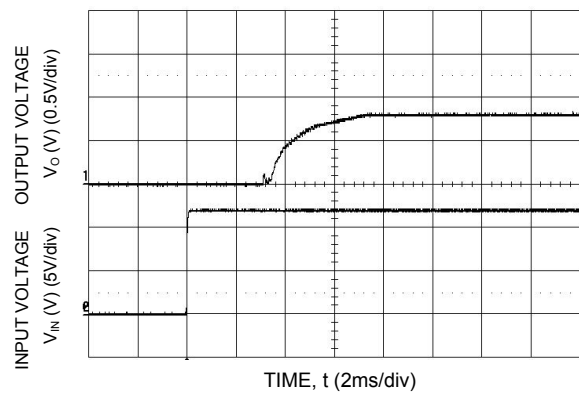

Figure 6. Typical Start-up Using Input Voltage ($V_{IN} = V_{IN,NOM}$, $I_o = I_{o,max}$).

Characteristic Curves

The following figures provide typical characteristics for the ATS025A0X (1.8V, 25A) at 25°C.

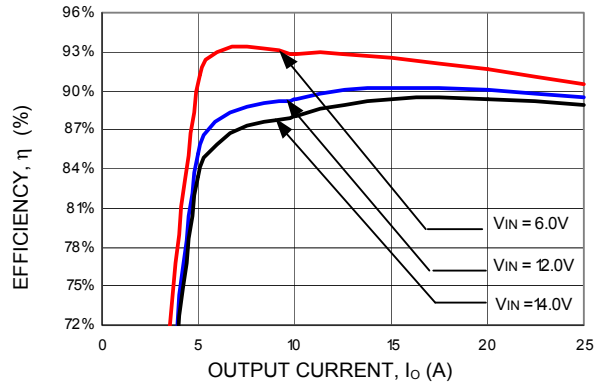

Figure 7. Converter Efficiency versus Output Current.

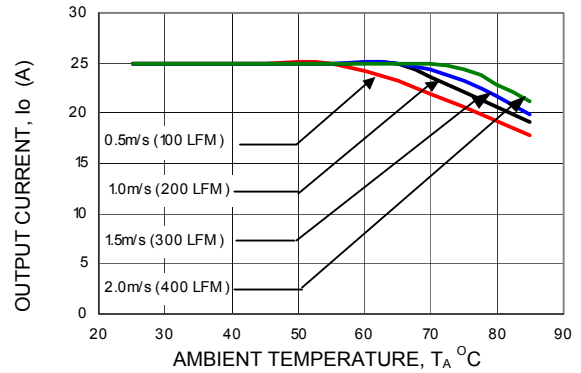

Figure 10. Derating Output Current versus Local Ambient Temperature and Airflow ($V_{IN} = V_{IN,NOM}$).

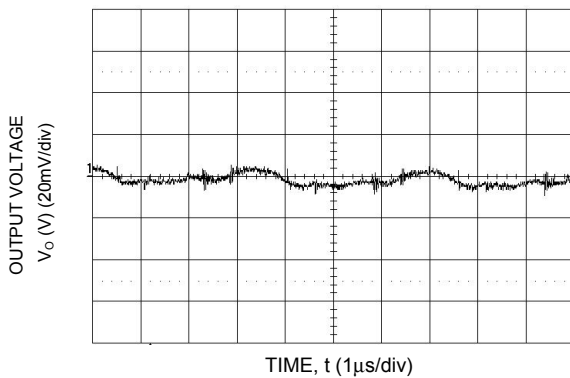

Figure 8. Typical output ripple and noise ($V_{IN} = V_{IN,NOM}$, $I_o = I_{o,max}$).

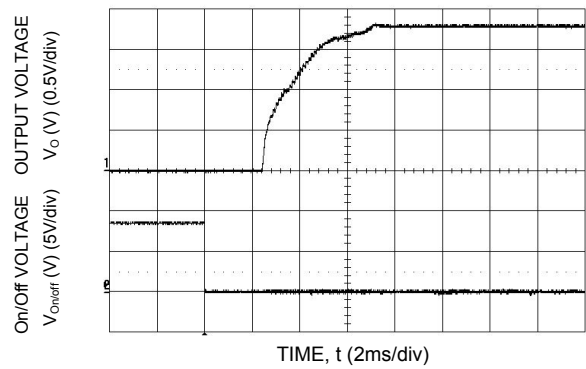

Figure 11. Typical Start-up Using Remote On/Off ($V_{IN} = V_{IN,NOM}$, $I_o = I_{o,max}$).

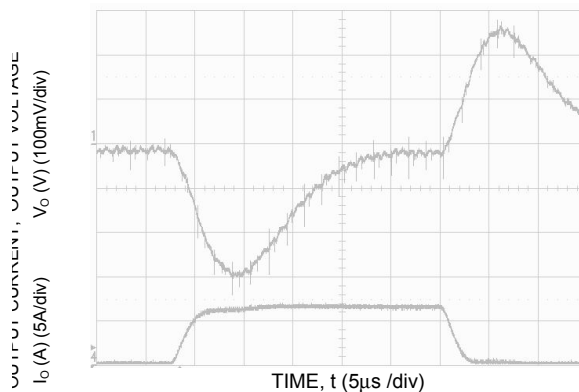

Figure 9. Transient Response to Dynamic Load Change from 0% to 50% to 0% of full load.

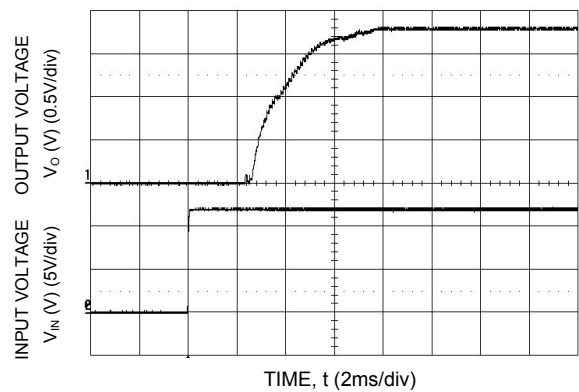

Figure 12. Typical Start-up Using Input Voltage ($V_{IN} = V_{IN,NOM}$, $I_o = I_{o,max}$).

Characteristic Curves

The following figures provide typical characteristics for the ATS025A0X (3.3V, 25A) at 25°C.

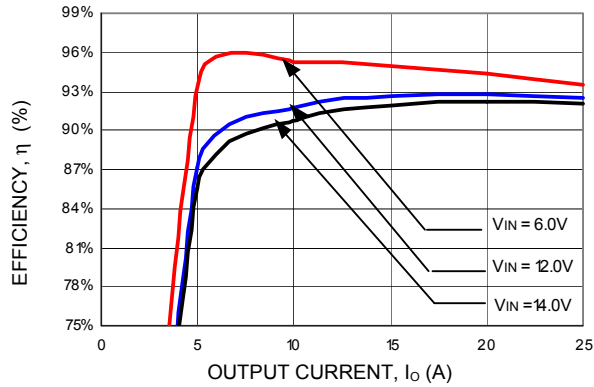

Figure 13. Converter Efficiency versus Output Current.

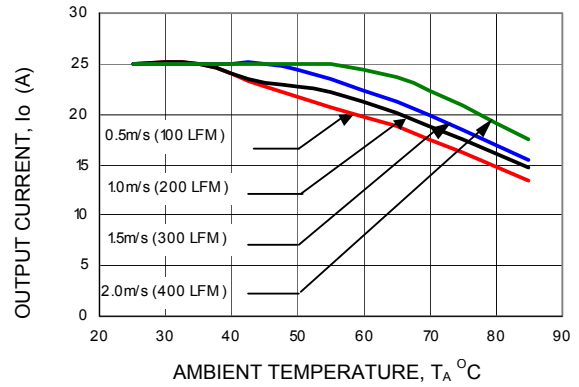

Figure 16. Derating Output Current versus Local Ambient Temperature and Airflow.

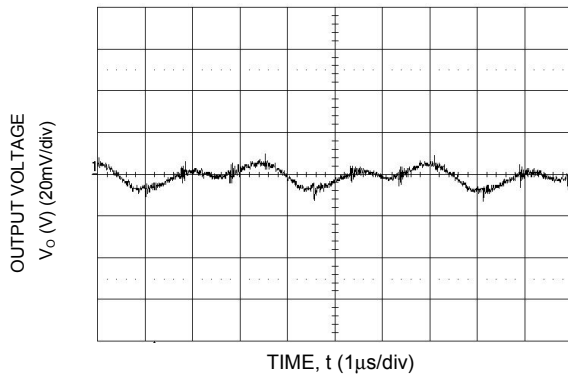

Figure 14. Typical output ripple and noise ($V_{IN} = V_{IN,NOM}$, $I_o = I_{o,max}$).

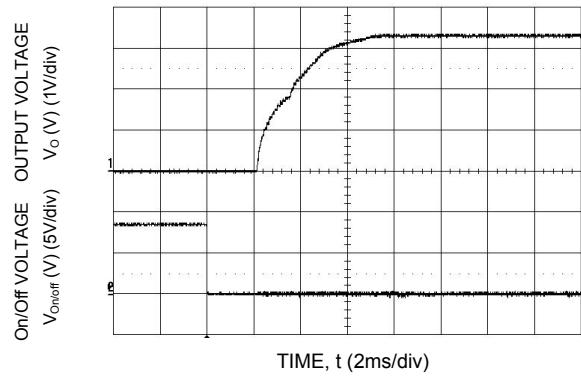

Figure 17. Typical Start-up Using Remote On/Off ($V_{IN} = V_{IN,NOM}$, $I_o = I_{o,max}$).

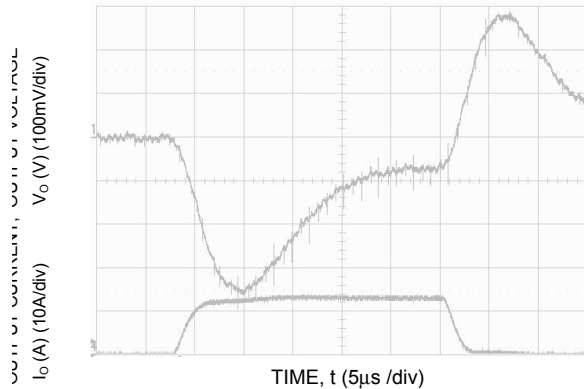

Figure 15. Transient Response to Dynamic Load Change from 0% to 50% to 0% of full load.

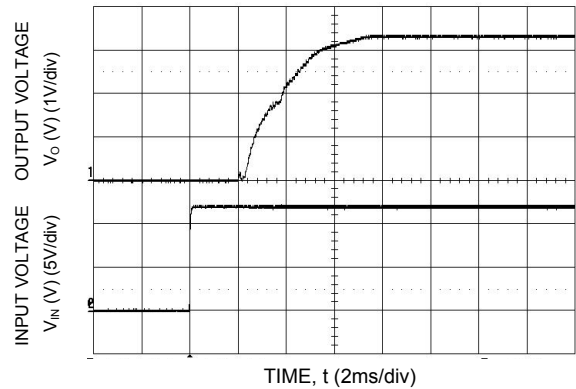

Figure 18. Typical Start-up Using Input Voltage ($V_{IN} = V_{IN,NOM}$, $I_o = I_{o,max}$).

Characteristic Curves

The following figures provide typical characteristics for the ATH030A0X (0.8V, 30A) at 25°C.

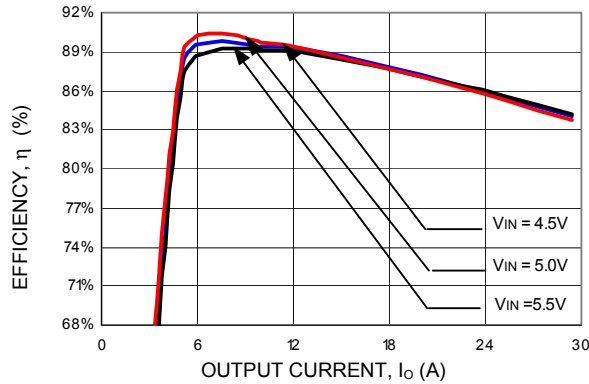

Figure 19. Converter Efficiency versus Output Current.

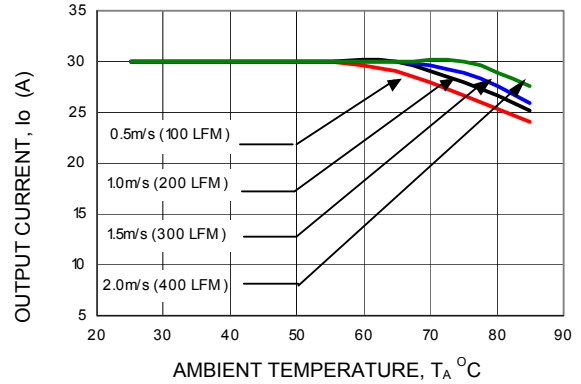

Figure 22. Derating Output Current versus Local Ambient Temperature and Airflow.

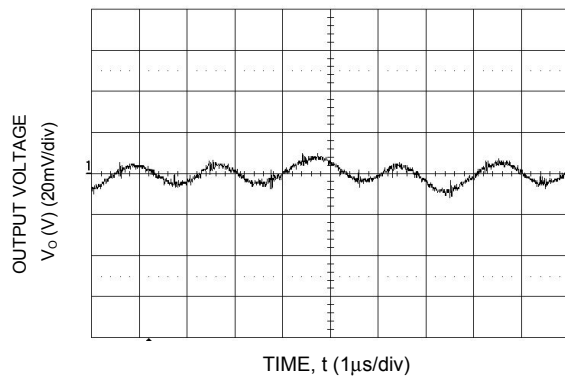

Figure 20. Typical output ripple and noise ($V_{IN} = V_{IN,NOM}$, $I_o = I_{o,max}$).

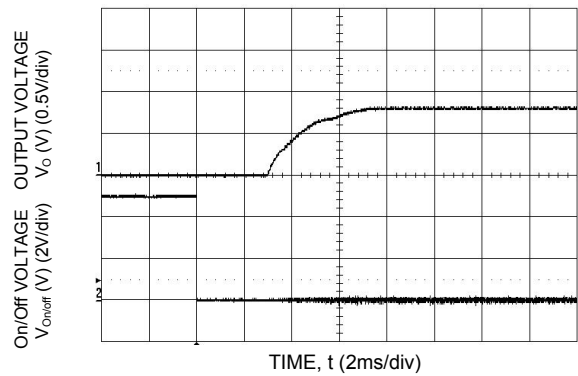

Figure 23. Typical Start-up Using Remote On/Off ($V_{IN} = V_{IN,NOM}$, $I_o = I_{o,max}$).

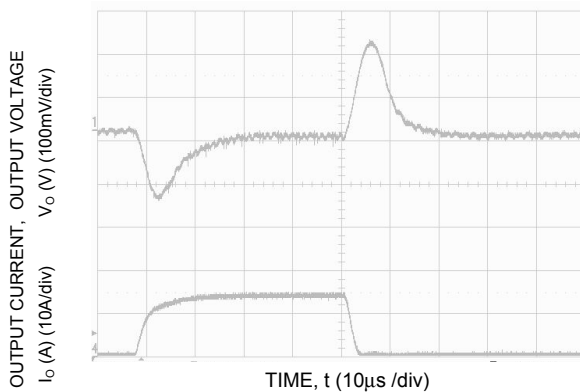

Figure 21. Transient Response to Dynamic Load Change from 0% to 50% to 0% of full load.

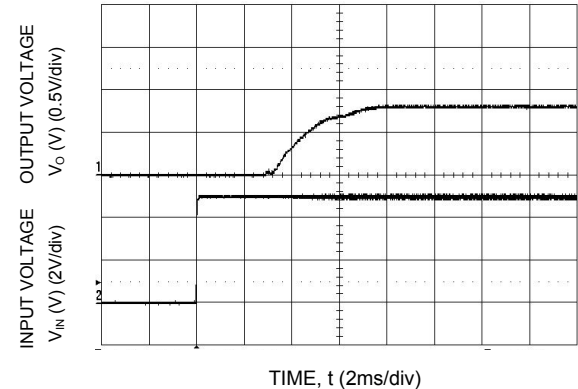

Figure 24. Typical Start-up Using Input Voltage ($V_{IN} = V_{IN,NOM}$, $I_o = I_{o,max}$).

Characteristic Curves

The following figures provide typical characteristics for the ATH030A0X (1.8V, 30A) at 25°C.

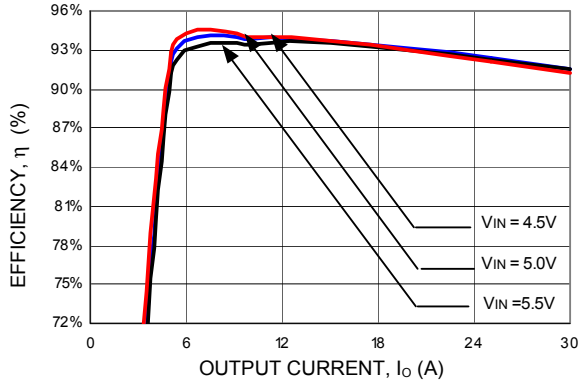

Figure 25. Converter Efficiency versus Output Current.

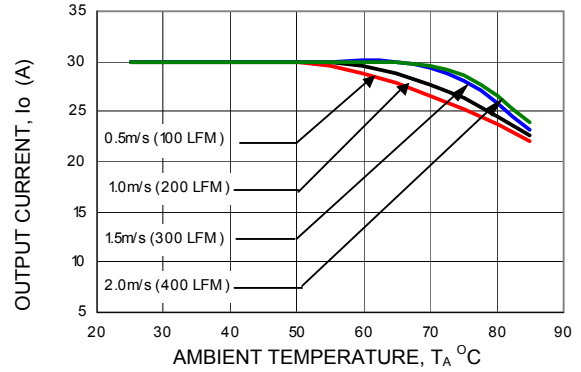

Figure 28. Derating Output Current versus Local Ambient Temperature and Airflow.

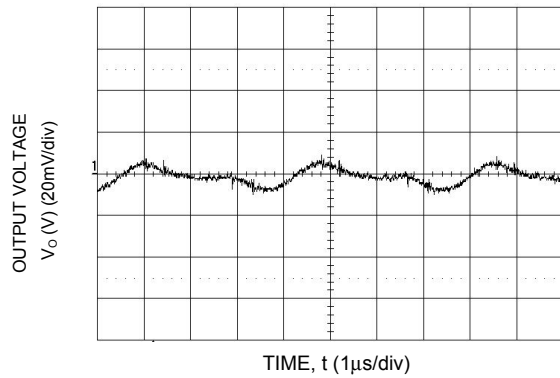

Figure 26. Typical output ripple and noise ($V_{IN} = V_{IN,NOM}$, $I_o = I_{o,max}$).

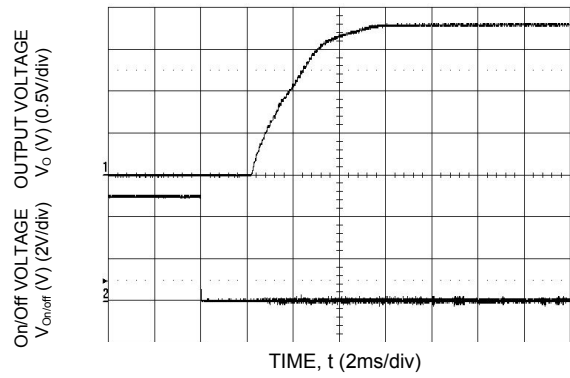

Figure 29. Typical Start-up Using Remote On/Off ($V_{IN} = V_{IN,NOM}$, $I_o = I_{o,max}$).

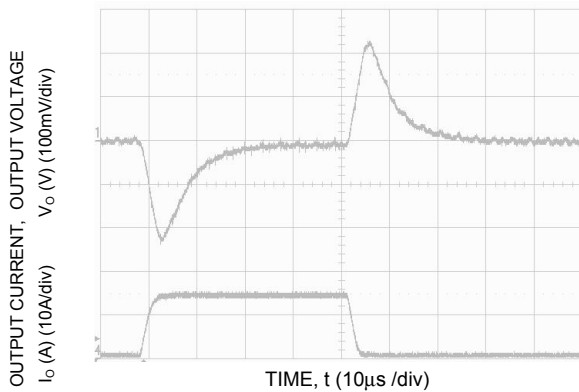

Figure 27. Transient Response to Dynamic Load Change from 0% to 50% to 0% of full load.

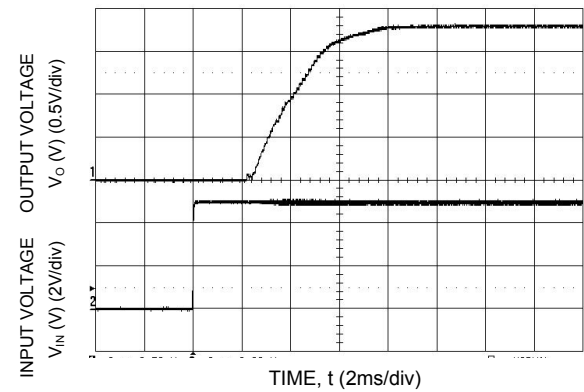

Figure 30. Typical Start-up Using Input Voltage ($V_{IN} = V_{IN,NOM}$, $I_o = I_{o,max}$).

Characteristic Curves

The following figures provide typical characteristics for the ATH030A0X (3.3V, 30A) at 25°C.

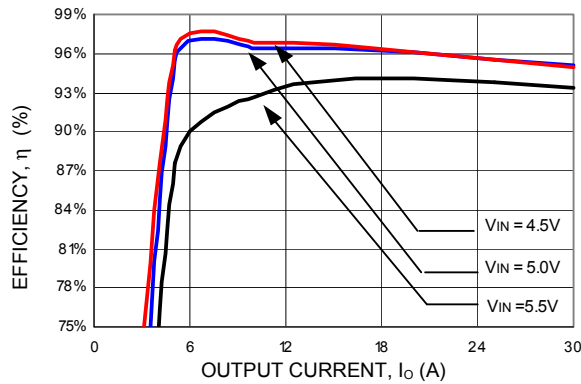

Figure 31. Converter Efficiency versus Output Current.

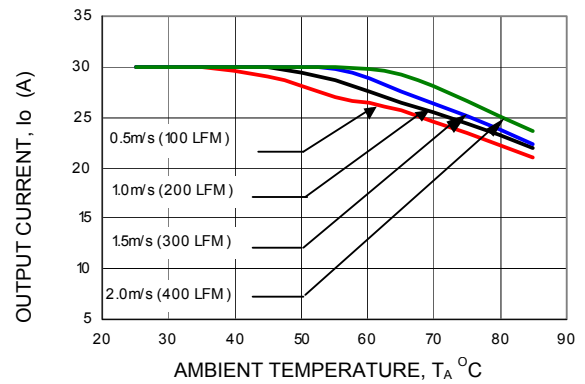

Figure 34. Derating Output Current versus Local Ambient Temperature and Airflow.

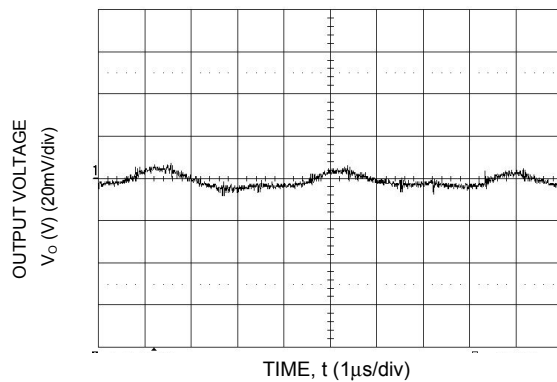

Figure 32. Typical output ripple and noise ($V_{IN} = V_{IN,NOM}$, $I_o = I_{o,max}$).

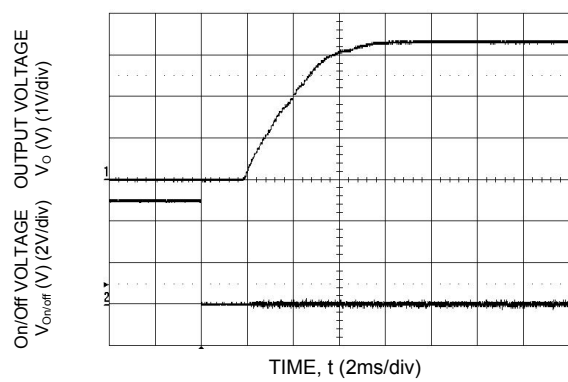

Figure 35. Typical Start-up Using Remote On/Off ($V_{IN} = V_{IN,NOM}$, $I_o = I_{o,max}$).

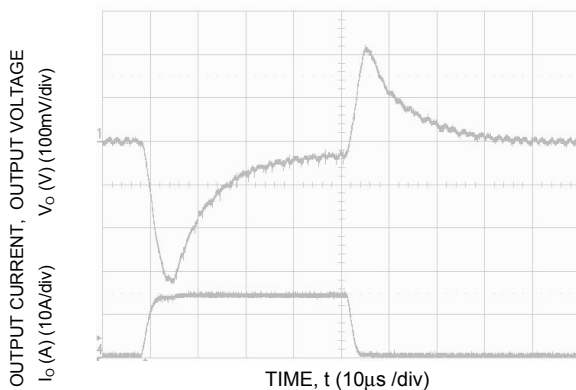

Figure 33. Transient Response to Dynamic Load Change from 0% to 50% to 0% of full load.

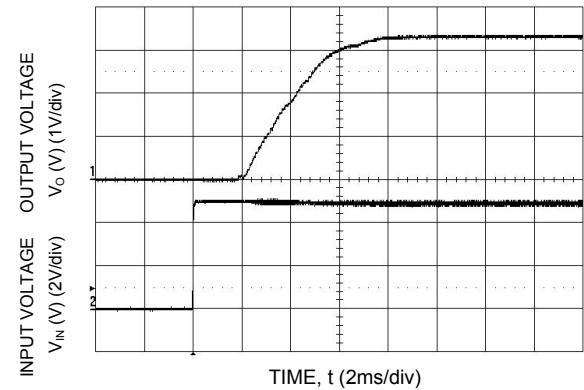
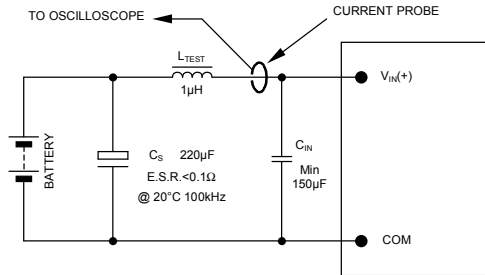

Figure 36. Typical Start-up Using Input Voltage ($V_{IN} = V_{IN,NOM}$, $I_o = I_{o,max}$).

Test Configurations



NOTE: Measure input reflected ripple current with a simulated source inductance (L_{TEST}) of $1\mu\text{H}$. Capacitor C_S offsets possible battery impedance. Measure current as shown above.

Figure 37. Input Reflected Ripple Current Test Setup.

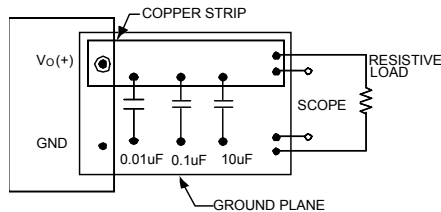

NOTE: All voltage measurements to be taken at the module terminals, as shown above. If sockets are used then Kelvin connections are required at the module terminals to avoid measurement errors due to socket contact resistance.

Figure 38. Output Ripple and Noise Test Setup.

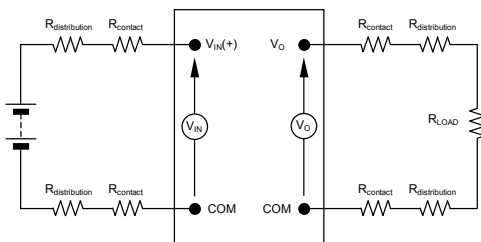

NOTE: All voltage measurements to be taken at the module terminals, as shown above. If sockets are used then Kelvin connections are required at the module terminals to avoid measurement errors due to socket contact resistance.

Figure 40. Output Voltage and Efficiency Test Setup.

$$\text{Efficiency } \eta = \frac{V_O \cdot I_O}{V_{IN} \cdot I_{IN}} \times 100 \%$$

Design Considerations

The Austin MegaLynx™ module should be connected to a low-impedance source. A highly inductive source can affect the stability of the module. An input capacitance must be placed directly adjacent to the input pin of the module, to minimize input ripple voltage and ensure module stability.

To minimize input voltage ripple, low-ESR ceramic capacitors are recommended at the input of the module. Figure 41 shows the input ripple voltage for various output voltages at 25A of load current with $2 \times 22\mu\text{F}$ or $4 \times 22\mu\text{F}$ ceramic capacitors and an input of 12V. Figure 42 shows data for the 5Vin case, with $2 \times 47\mu\text{F}$ and $4 \times 47\mu\text{F}$ of ceramic capacitors at the input, and for a load current of 30A.

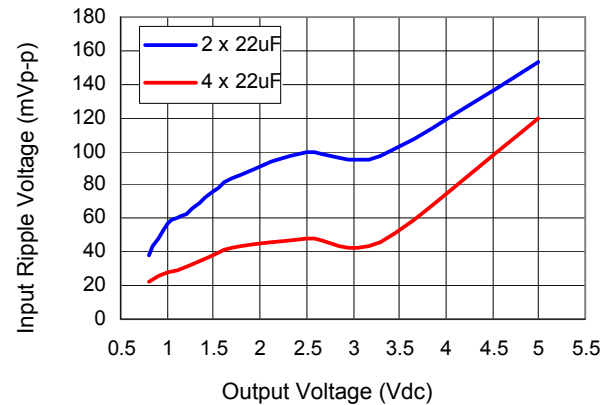

Figure 41. Input ripple voltage for various output voltages with $2 \times 22\mu\text{F}$ or $4 \times 22\mu\text{F}$ ceramic capacitors at the input (25A load). Input voltage is 12V.

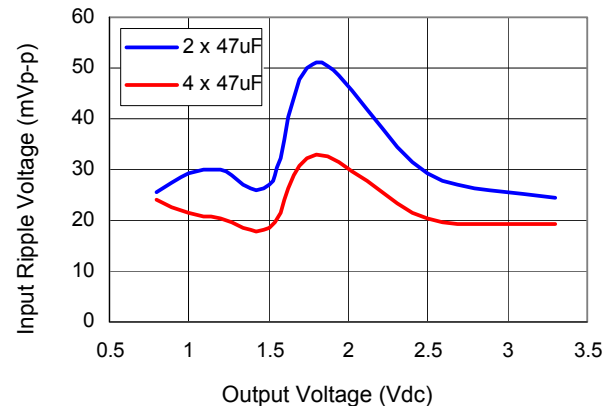

Figure 42. Input ripple voltage in mV, p-p for various output voltages with $2 \times 47\mu\text{F}$ or $4 \times 47\mu\text{F}$ ceramic capacitors at the input (25A load). Input voltage is 5V.

Safety Considerations

For safety agency approval the power module must be installed in compliance with the spacing and separation requirements of the end-use safety agency standards, i.e., UL 60950, CSA C22.2 No. 60950-00, EN60950 (VDE 0850) (IEC60950, 3rd edition) Licensed.

For the converter output to be considered meeting the requirements of safety extra-low voltage (SELV), the input must meet SELV requirements. The power module has extra-low voltage (ELV) outputs when all inputs are ELV.

Feature Descriptions

Remote On/Off

The Austin MegaLynx power modules feature a On/Off pin for remote On/Off operation. If not using the On/Off pin, connect the pin to ground (the module will be ON). The On/Off signal ($V_{on/off}$) is referenced to ground. Circuit configuration for remote On/Off operation of the module using the On/Off pin is shown in Figure 43.

During a Logic High on the On/Off pin (transistor Q1 is OFF), the module remains OFF. The external resistor R1 should be chosen to maintain 3.0V minimum on the On/Off pin to ensure that the module is OFF when transistor Q1 is in the OFF state. Suitable values for R1 are 4.7K for input voltage of 12V and 3K for 5V_{in}. During Logic-Low when Q1 is turned ON, the module is turned ON.

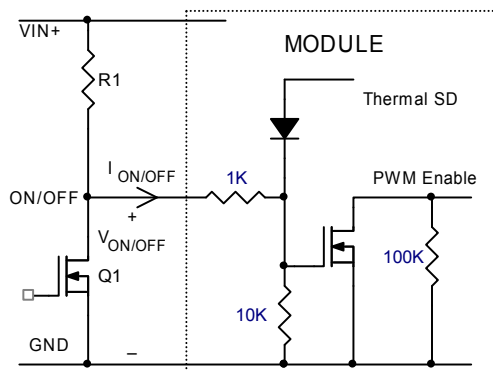

Figure 43. Remote On/Off Implementation using ON/OFF.

The On/Off pin can also be used to synchronize the output voltage start-up and shutdown of multiple modules in parallel. By connecting together the On/Off pins of multiple modules, the output start-up can be synchronized (please refer to characterization curves). When On/Off pins are connected together, all modules will shut down if any one of the modules gets disabled

due to undervoltage lockout or over temperature protection.

Remote Sense

The Austin MegaLynx SIP power modules have a remote sense feature to minimize the effects of distribution losses by regulating the voltage at the remote sense pin (See Figure 44). The voltage between the Sense pin and the Vo pin must not exceed 0.5V.

The amount of power delivered by the module is defined as the output voltage multiplied by the output current ($V_o \times I_o$). When using Remote Sense, the output voltage of the module can increase, which if the same output is maintained, increases the power output from the module. Make sure that the maximum output power of the module remains at or below the maximum rated power. When the Remote Sense feature is not being used, connect the Remote Sense pin to output of the module.

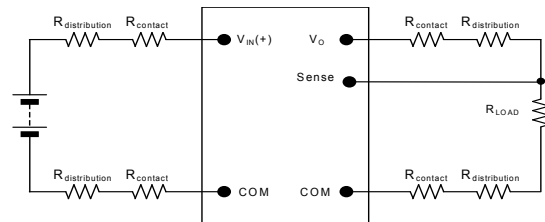

Figure 44. Effective Circuit Configuration for Remote Sense operation.

Over Current Protection

To provide protection in a fault (output overload) condition, the unit is equipped with internal current-limiting circuitry and can endure current limiting continuously. At the point of current-limit inception, the unit enters hiccup mode. The unit operates normally once the output current is brought back into its specified range. The average output current during hiccup is 20% $I_{o, max}$.

Over Temperature Protection

To provide protection in a fault condition, the unit is equipped with a thermal shutdown circuit. The unit will shutdown if the overtemperature threshold of 130°C is exceeded at the thermal reference point T_{ref} . The thermal shutdown is not intended as a guarantee that the unit will survive temperatures beyond its rating. Once the unit goes into thermal shutdown it will then wait to cool before attempting to restart.

Input Under Voltage Lockout

At input voltages below the input undervoltage lockout limit, the module operation is disabled. The module will begin to operate at an input voltage above the undervoltage lockout turn-on threshold.

Output Voltage Programming

The output voltage of the Austin MegaLynx can be programmed to any voltage from 0.8dc to 5.0Vdc by connecting a resistor (shown as R_{trim} in Figure 45) between Trim and GND pins of the module. Without an external resistor between Trim and GND pins, the output of the module will be 0.8Vdc. To calculate the value of the trim resistor, R_{trim} for a desired output voltage, use the following equation:

$$R_{trim} = \left[\frac{1200}{V_o - 0.80} - 100 \right] \Omega$$

R_{trim} is the external resistor in Ω

V_o is the desired output voltage

By using a $\pm 0.5\%$ tolerance trim resistor with a TC of $\pm 100\text{ppm}$, a set point tolerance of $\pm 1.5\%$ can be achieved as specified in the electrical specification. Table 1 provides R_{trim} values required for some common output voltages. The POL Programming Tool, available at www.lineagepower.com under the Design Tools section, helps determine the required external trim resistor needed for a specific output voltage.

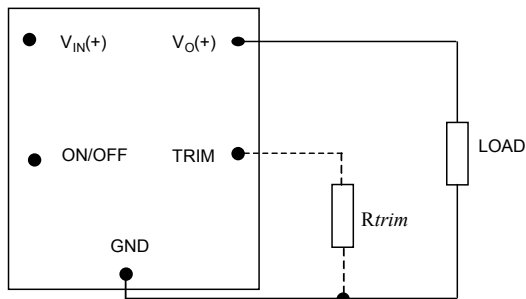

Figure 45. Circuit configuration to program output voltage using an external resistor.

Table 1

$V_{O, set}$ (V)	R_{trim} (Ω)
0.8	Open
1.0	5900
1.2	2900
1.5	1614
1.8	1100
2.5	606
3.3	380
5.0	186

Voltage Margining

Output voltage margining can be implemented in the Austin MegaLynx modules by connecting a resistor, $R_{margin-up}$, from the Trim pin to the ground pin for margining-up the output voltage and by connecting a resistor, $R_{margin-down}$, from the Trim pin to output pin for margining-down. Figure 46 shows the circuit configuration for output voltage margining. The POL Programming Tool, available at www.lineagepower.com under the Design Tools section, also calculates the values of $R_{margin-up}$ and $R_{margin-down}$ for a specific output voltage and % margin. Please consult your local Lineage Power technical representative for additional details.

Voltage Sequencing

The Austin MegaLynx series of modules include a sequencing feature that enables users to implement various types of output voltage sequencing in their applications. This is accomplished via an additional sequencing pin. When not using the sequencing feature, either leave the SEQ pin unconnected or tied to V_{IN} .

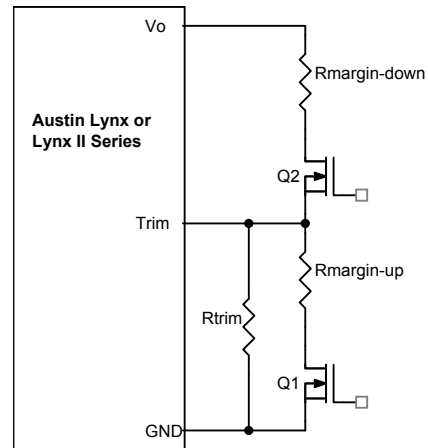

Figure 46. Circuit Configuration for margining Output voltage.

For proper voltage sequencing, first, input voltage is applied to the module. The On/Off pin of the module is left unconnected or tied to GND for negative logic modules so that the module is ON by default. After applying input voltage to the module, a delay of 10msec minimum is required before applying voltage on the SEQ pin. During this delay time, the SEQ pin should be kept at a voltage of 50mV (± 20 mV). After the 10msec delay, the voltage applied to the SEQ pin is allowed to vary and the output voltage of the module will track this voltage on a one-to-one volt basis until the output reaches the set-point voltage. To initiate simultaneous shutdown of the modules, the sequence pin voltage is lowered in a controlled manner. The output voltages of the modules track the sequence pin voltage when it falls below their set-point voltages. A valid input voltage must be maintained until the tracking and output voltages reach zero to ensure a controlled shutdown of the modules. For a more detailed description of sequencing, please refer to **Application Note AN04-008 titled "Guidelines for Sequencing of Multiple Modules"**.

When using the EZ-SEQUENCE™ feature to control start-up of the module, pre-bias immunity feature during start-up is disabled. The pre-bias immunity feature of the module relies on the module being in the diode-mode during start-up. When using the EZ-SEQUENCE™ feature, modules goes through an internal set-up time of 10msec, and will be in synchronous rectification mode when voltage at the SEQ pin is applied. This will result in sinking current in the module if pre-bias voltage is present at the output of the module. When pre-bias immunity during start-up is required, the EZ-SEQUENCE™ feature must be disabled.

Active Load Sharing (-P Option)

For additional power requirements, the Austin MegaLynx series power module is also available with a parallel option. Up to five modules can be configured, in parallel, with active load sharing. Good layout techniques should be observed when using multiple units in parallel. To implement forced load sharing, the following connections should be made:

- The share pins of all units in parallel must be connected together. The path of these connections should be as direct as possible.
- All remote-sense pins should be connected to the power bus at the same point, i.e., connect all the SENSE(+) pins to the (+) side of the bus. Close proximity and directness are necessary for good noise immunity

Some special considerations apply for design of converters in parallel operation:

- When sizing the number of modules required for parallel operation, take note of the fact that current sharing has some tolerance. In addition, under transient conditions such as a dynamic load change and during startup, all converter output currents will

not be equal. To allow for such variation and avoid the likelihood of a converter shutting off due to a current overload, the total capacity of the paralleled system should be no more than 75% of the sum of the individual converters. As an example, for a system of four ATS030A0X3-SR converters the parallel, the total current drawn should be less than 75% of (4 x 30A), i.e. less than 90A.

- All modules should be turned on and off together. This is so that all modules come up at the same time avoiding the problem of one converter sourcing current into the other leading to an overcurrent trip condition. To ensure that all modules come up simultaneously, the on/off pins of all paralleled converters should be tied together and the converters enabled and disabled using the on/off pin.
- The share bus is not designed for redundant operation and the system will be non-functional upon failure of one of the unit when multiple units are in parallel. In particular, if one of the converters shuts down during operation, the other converters may also shut down due to their outputs hitting current limit. In such a situation, unless a coordinated restart is ensured, the system may never properly restart since different converters will try to restart at different times causing an overload condition and subsequent shutdown. This situation can be avoided by having an external output voltage monitor circuit that detects a shutdown condition and forces all converters to shut down and restart together.

Thermal Considerations

Power modules operate in a variety of thermal environments; however, sufficient cooling should always be provided to help ensure reliable operation.

Considerations include ambient temperature, airflow, module power dissipation, and the need for increased reliability. A reduction in the operating temperature of the module will result in an increase in reliability. The thermal data presented here is based on physical measurements taken in a wind tunnel. The test set-up is shown in Figure 47. Note that the airflow is parallel to the long axis of the module as shown in Figure 48. The derating data applies to airflow in either direction of the module's long axis.

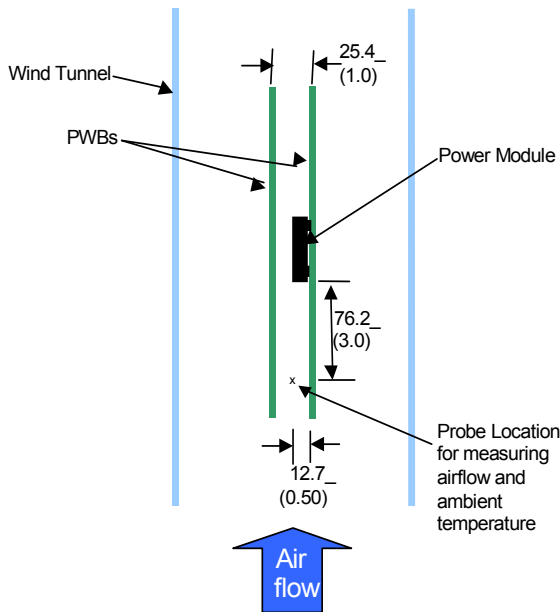

Figure 47. Thermal Test Set-up.

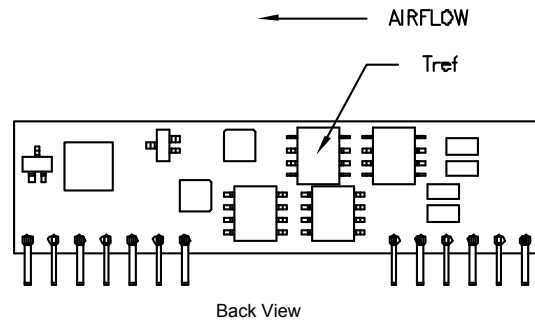

Figure 48. T_{ref} Temperature measurement location.

The thermal reference point, T_{ref} used in the specifications is shown in Figure 48. For reliable operation this temperature should not exceed 125°C.

The output power of the module should not exceed the rated power of the module ($V_{o,set} \times I_{o,max}$).

Please refer to the Application Note "Thermal Characterization Process For Open-Frame Board-Mounted Power Modules" for a detailed discussion of thermal aspects including maximum device temperatures.

Mechanical Outline of Module

Dimensions are in millimeters and (inches).

Tolerances: x.x mm ± 0.5 mm (x.xx in. ± 0.02 in.) [unless otherwise indicated]

x.xx mm ± 0.25 mm (x.xxx in ± 0.010 in)

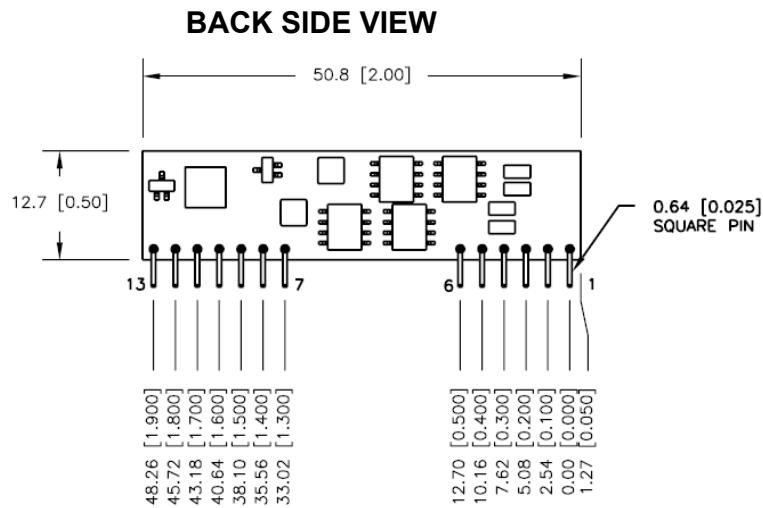

Pin out

Pin	Function
1	Vo
2	Vo
3	Sense+
4	Vo
5	GND
6	GND*
7	Share**
8	GND
9	VIN
10	VIN
11	SEQ
12	Trim
13	On/Off

Pin 6 is added in
 ATH030A0X3 version

** Pin 7 is paralleling
 option

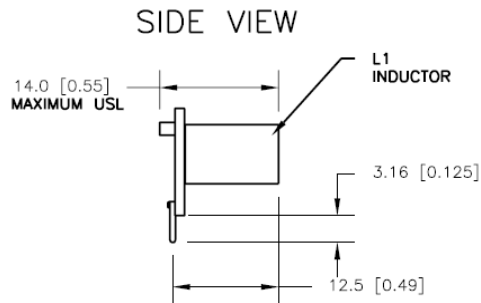

Recommended Pad Layout

Dimensions are in millimeters and (inches).

Tolerances: x.x mm ± 0.5 mm (x.xx in. ± 0.02 in.) [unless otherwise indicated]

x.xx mm ± 0.25 mm (x.xxx in ± 0.010 in)

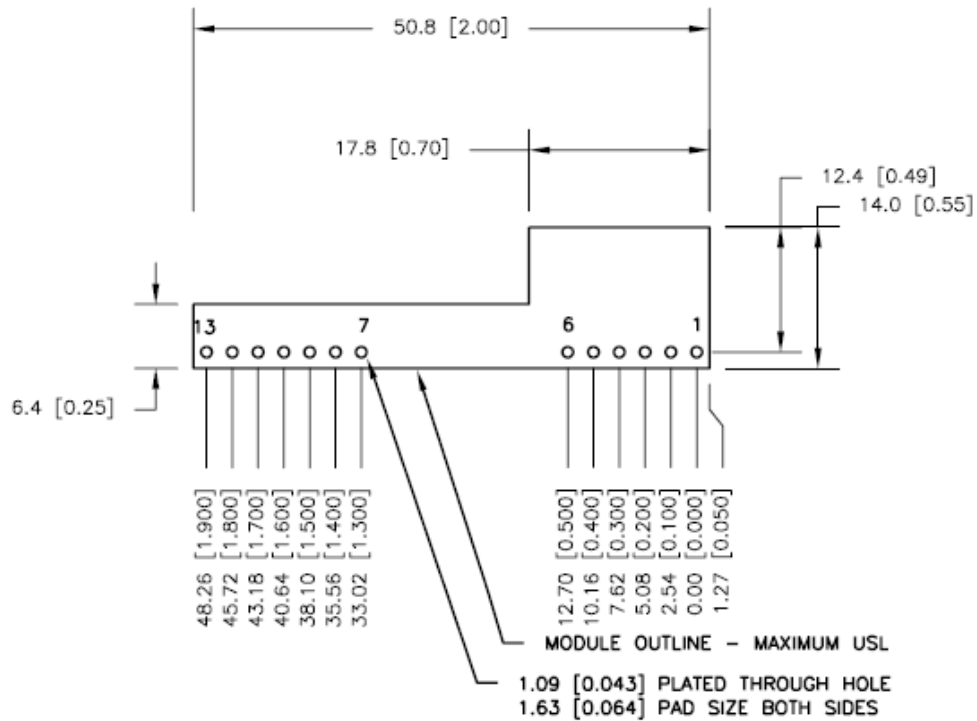

Through-Hole Lead-Free Soldering Information

The RoHS-compliant through-hole products use the SAC (Sn/Ag/Cu) Pb-free solder and RoHS-compliant components. They are designed to be processed through single or dual wave soldering machines. The pins have an RoHS-compliant finish that is compatible with both Pb and Pb-free wave soldering processes. A maximum preheat rate of 3°C/s is suggested. The wave preheat process should be such that the temperature of the power module board is kept below 210°C. For Pb solder, the recommended pot temperature is 260°C, while the Pb-free solder pot is 270°C max. Not all RoHS-compliant through-hole products can be processed with paste-through-hole Pb or Pb-free reflow process. If additional information is needed, please consult with your Lineage Power technical representative for more details.

Ordering Information

Please contact your Lineage Power Sales Representative for pricing, availability and optional features.

Table 2. Device Codes

Input Voltage	Output Voltage	Output Current	On/Off Logic	Connector Type	Product codes	Comcodes
4.5 – 5.5Vdc	0.8 – 3.63Vdc	25A	Negative	SIP	ATH025A0X3	108991980
4.5 – 5.5Vdc	0.8 – 3.63Vdc	25A	Negative	SIP	ATH025A0X3Z	CC109104774
4.5 – 5.5Vdc	0.8 – 3.63Vdc	30A	Negative	SIP	ATH030A0X3	108992005
4.5 – 5.5Vdc	0.8 – 3.63Vdc	30A	Negative	SIP	ATH030A0X3Z	CC109104782
4.5 – 5.5Vdc	0.8 – 3.63Vdc	30A	Negative	SIP	ATH030A0X3-P	108993358
4.5 – 5.5Vdc	0.8 – 3.63Vdc	30A	Negative	SIP	ATH030A0X3-PZ	CC109104790
6.0 – 14Vdc	0.8– 5.5Vdc	25A	Negative	SIP	ATS025A0X3	108991997
6.0 – 14Vdc	0.8– 5.5Vdc	25A	Negative	SIP	ATS025A0X3Z	CC109104808
6.0 – 14Vdc	0.8– 5.5Vdc	25A	Negative	SIP	ATS025A0X53	108997210
6.0 – 14Vdc	0.8– 5.5Vdc	25A	Negative	SIP	ATS025A0X3-P	108993341
6.0 – 14Vdc	0.8– 5.5Vdc	25A	Negative	SIP	ATS025A0X3-PZ	CC109104816
6.0 – 14Vdc	0.8– 5.5Vdc	25A	Negative	SIP	ATS025A0X53-PZ	CC109107752
6.0 – 14Vdc	0.8– 5.5Vdc	25A	Negative	SIP	ATS025A0X3-34Z*	CC109147897

* Special part, consult factory before ordering

Table 3. Device Options

Option	Device Code Suffix
Long pins 5.08mm ± 0.25m (0.2 in. ± 0.010 in.)	-5
Paralleling with active current sharing	-P
RoHS Compliant	-Z



World Wide Headquarters
Lineage Power Corporation
601 Shiloh Road, Plano, TX 75074, USA
+1-888-LINEAGE(546-3243)
(Outside U.S.A.: **+1-972-244-WATT(9288)**)
www.lineagepower.com
e-mail: techsupport1@lineagepower.com

Asia-Pacific Headquarters
Tel: +86.021.54279977*808

Europe, Middle-East and Africa Headquarters
Tel: +49.89.878067-280

India Headquarters
Tel: +91.80.28411633

Lineage Power reserves the right to make changes to the product(s) or information contained herein without notice. No liability is assumed as a result of their use or application. No rights under any patent accompany the sale of any such product(s) or information.

Lineage Power DC-DC products are protected under various patents. Information on these patents is available at www.lineagepower.com/patents.

© 2011 Lineage Power Corporation, (Plano, Texas) All International Rights Reserved.