

Available from Midas Components LTD  
Telephone Number: +44(0) 1493 602602  
Website: [www.midascomponents.co.uk](http://www.midascomponents.co.uk)  
Email: [sales@midascomponents.co.uk](mailto:sales@midascomponents.co.uk)

# **Specification for BTHQ 100032V-FSTF-LEDwhite W.C.**

Version June 2003

**DOCUMENT REVISION HISTORY 1:**

DOCUMENT REVISION FROM TO	DATE	DESCRIPTION	CHANGED BY	CHECKED BY
A	2002.01.28		PHILIP CHENG	Z.B.HE
A B	2002.02.04	Item 1 was updated: 1.)(Page 8, point 5.1, table 5) Forward voltage of white LED05 backlight was changed from 3.4V±0.3V to 3.4V±0.2V.	PHILIP CHENG	Z.B.HE
B C	2003.06.25	(Based on Test Specification VL-TS-BTHQ 100032V-XX REV. E 2003-05-25).  Item 1 to 8 were updated:  1) Requested by customer, Item description was changed to “BTHQ 100032V-FSTF-LEDwhite W.C.”. 2) (P.4,point 1)Connector was added. 3) (P.4,table 1)”(Excluded connector)” and weight were added. 4) (P.5)Figure1: Module specification Revision was updated to Rev.1. 5) (P.8,table 5)Supply voltage VLCD was changed to 6.0±0.3. 6) (P.8,table 5)VLCD at extreme temperature were added in. 7) (P.8,table 5)Current I0 & IDD were updated. 8) (Page 11-12) Appendix was updated.	SUNNY LEE	HE ZUO BING

## CONTENTS

	<u>Page No.</u>
1. GENERAL DESCRIPTION	4
2. MECHANICAL SPECIFICATIONS	4
3. INTERFACE SIGNALS	6
4. ABSOLUTE MAXIMUM RATINGS	7
4.1 ELECTRICAL MAXIMUM RATINGS (Ta=25°C)	7
4.2 ENVIRONMENTAL CONDITION	7
5. ELECTRICAL SPECIFICATIONS	8
5.1 TYPICAL ELECTRICAL CHARACTERISTICS	8
5.2 TIMING SPECIFICATIONS	9
5.3 TIMING DIAGRAM OF VDD AGAINST V0	10
6. APPENDIX – LED SPECIFICATIONS	11

**Specification  
of  
LCD Module Type  
Model No.: BTHQ 100032V-02**

**1. General Description**

- 100 x 32 dots FSTN Positive Black & White Transflective Dot Matrix LCD Module.
- Viewing Angle: 6 O'clock direction.
- Driving scheme: 1/32 duty, 1/6.7 bias.
- 'Epson' SED1520 D0A (Die Form) dot matrix LCD drivers or equivalent.
- White LED05 backlight.
- Connector.

**2. Mechanical Specifications**

The mechanical detail is shown in Fig. 1 and summarized in Table 1 below.

Table 1

Parameter	Specifications	Unit
Outline dimensions	65.0(W) x 28.4(H) x 8.5 MAX.(D) (Excluded connector)	mm
Effective viewing area	46.0(W) x 18.4(H)	mm
Active area	42.99(W) x 15.31(H)	mm
Display format	100 x 32	dots
Dot size	0.415(W) x 0.464(H)	mm
Dot spacing	0.015(W) x 0.015(H)	mm
Dot pitch	0.430(W) x 0.479(H)	mm
Weight:	Approx. 18.0	Grams

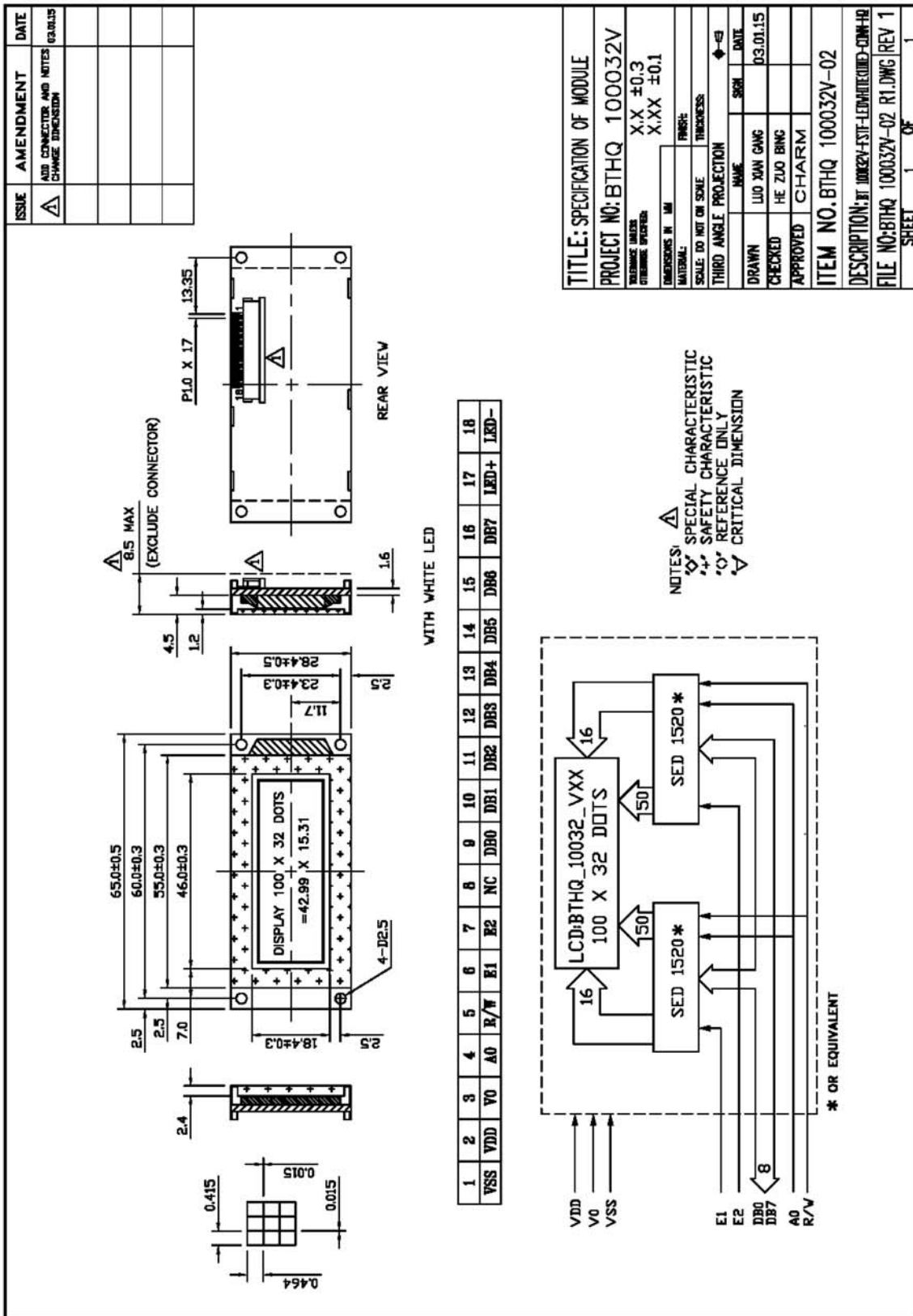

Figure 1: Specification Drawing

**3. Interface signals**Table 2

Pin No.	Symbol	Description
1	VSS	Ground (0V)
2	VDD	Power supply for logic (+5V)
3	V0	Power supply for LCD driver
4	A0	Data/Command Select Input 'High': Display data on DB0-DB7. 'Low': Display control data on DB0-DB7.
5	R/W	Chip interface with 68 family MPU: Read/Write control signal input pin. R/W = "High": Read control signals. R/W = "Low": Write control signals.
6	E1	For first LCD driver SED1520: Chip interfaced with 68 family MPU: Input. Active high. Enable clock signal input for the 68 family MPU.
7	E2	For second LCD driver SED1520: Chip interfaced with 68 family MPU: Input. Active high. Enable clock signal input for the 68 family MPU.
8	NC	No connection.
9	DB0	Data input/output (LSB)
10	DB1	Data input/output
11	DB2	Data input/output
12	DB3	Data input/output
13	DB4	Data input/output
14	DB5	Data input/output
15	DB6	Data input/output
16	DB7	Data input/output (MSB)
17	LED+	Anode of LED backlight.
18	LED-	Cathode of LED backlight.

#### 4. Absolute Maximum Ratings

##### 4.1 Electrical Maximum Ratings (Ta = 25 °C)

Table 3

Parameter	Symbol	Min.	Max.	Unit
Power Supply voltage (Logic)	VDD - VSS	-0.3	+8.0	V
Power Supply voltage (LCD drive)	VLCD =VDD - V0	-0.3	+16.5	V
Input voltage	Vin	-0.3	VDD +0.3	V

Note:

The modules may be destroyed if they are used beyond the absolute maximum ratings.

All voltage values are referenced to VSS = 0V.

##### 4.2 Environmental Condition

Table 4

Item	Operating Temperature (Topr)		Storage Temperature (Tstg)		Remark
	Min.	Max.	Min.	Max.	
Ambient Temperature	0°C	+50°C	-10°C	+60°C	Dry
Humidity	95% max. RH for Ta ≤ 40°C < 95% RH for Ta > 40°C				no condensation
Vibration (IEC 68-2-6) cells must be mounted on a suitable connector	Frequency: 10 ~ 55 Hz Amplitude: 0.75 mm Duration: 20 cycles in each direction.				3 directions
Shock (IEC 68-2-27) Half-sine pulse shape	Pulse duration : 11 ms Peak acceleration: 981 m/s <sup>2</sup> = 100g Number of shocks : 3 shocks in 3 mutually perpendicular axes.				3 directions

## 5. Electrical Specifications

### 5.1 Typical Electrical Characteristics

At  $T_a = 25\text{ }^\circ\text{C}$ ,  $V_{DD} = 5V \pm 5\%$ ,  $V_{SS} = 0V$ .

Table 5

Parameter	Symbol	Conditions	Min.	Typ.	Max.	Unit
Supply voltage (Logic)	$V_{DD} - V_{SS}$		4.75	5.0	5.25	V
Supply voltage (LCD)	$V_{LCD} = V_{DD} - V_0$	$T_a = -20\text{ }^\circ\text{C}$ , Character mode, $V_{DD} = 5V$ , Note 1.	-	6.31	-	V
		$T_a = +25\text{ }^\circ\text{C}$ , Character mode, $V_{DD} = 5V$ , Note 1.	5.7	6.0	6.3	V
		$T_a = +70\text{ }^\circ\text{C}$ , Character mode, $V_{DD} = 5V$ , Note 1.	-	5.69	-	V
Input signal voltage for E,DB0-DB7,R/W,A0	$V_{IH}$	“H” level	2.0	-	$V_{DD}$	V
	$V_{IL}$	“L” level	0	-	0.8	V
Supply current (Logic & LCD)	IDD	Character mode, Note 1	-	1.0	1.5	mA
		Checkerboard mode, Note 1	-	1.0	1.5	mA
Supply current (LCD)	I0	Character mode, Note 1	-	1.0	1.5	mA
		Checkerboard mode, Note 1	-	1.0	1.5	mA
Forward voltage of white LED05 backlight	VLED	Forward current $= 20\text{mA}$  Number of dies $= 1$	3.2	3.4	3.6	V

Note (1) : There is tolerance in optimum LCD driving voltage during production and it will be within the specified range.



## 5.2 Timing Specifications

At  $T_a = 0\text{ }^{\circ}\text{C}$  to  $+50\text{ }^{\circ}\text{C}$ ,  $V_{DD} = 5V \pm 5\%$ ,  $V_{SS} = 0V$ .

Refer to Fig. 2, MPU bus read / write II timing diagram (68 family MPU)

Table 6

Parameter	Signal	Symbol	Condition	Min.	Max.	Unit
System Cycle Time	A0,/CS,R/W	$t_{CYC6}$	-	1000	-	ns
Address Set-up Time	A0,/CS,R/W	$t_{AW6}$	-	20	-	ns
Address Hold Time	A0,/CS,R/W	$t_{AH6}$	-	10	-	ns
Data Set-up Time	DB0-DB7	$t_{DS6}$	-	80	-	ns
Data Hold Time	DB0-DB7	$t_{DH6}$	-	10	-	ns
Output Disable Time	DB0-DB7	$t_{OH6}$	CL=100pF	10	60	ns
Access Time	DB0-DB7	$t_{ACC6}$	CL=100pF	-	90	ns
Enable Pulse Width(Read)	E	$t_{EW}$	-	100	-	ns
Enable Pulse Width(Write)	E	$t_{EW}$	-	80	-	ns
Rise & Fall Time	-	tr, tf	-	-	15	ns

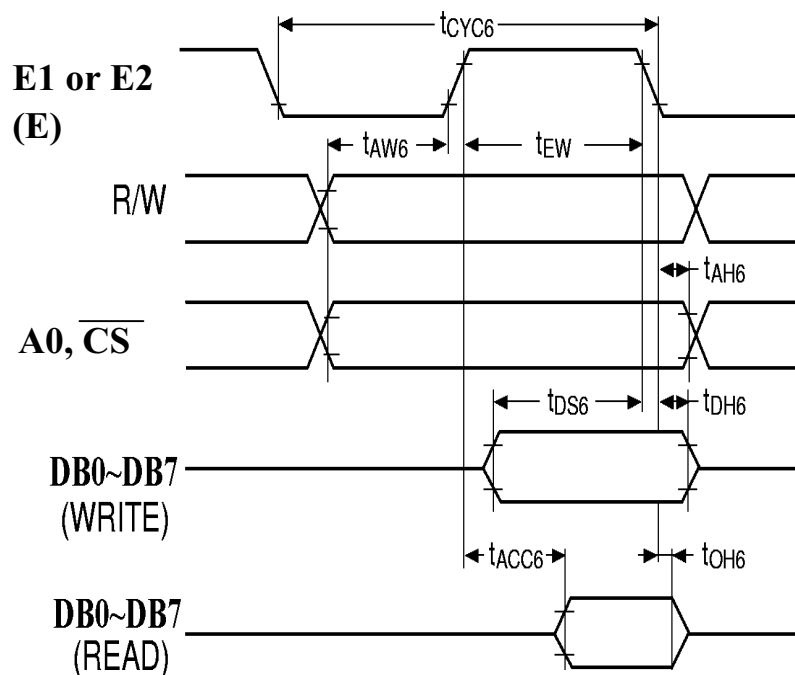

Figure 2: MPU bus read / write II timing diagram (68 family MPU)

### 5.3 Timing Diagram of VDD against V0.

Power on sequence shall meet the requirement of Figure 3, the timing diagram of VDD against V0.

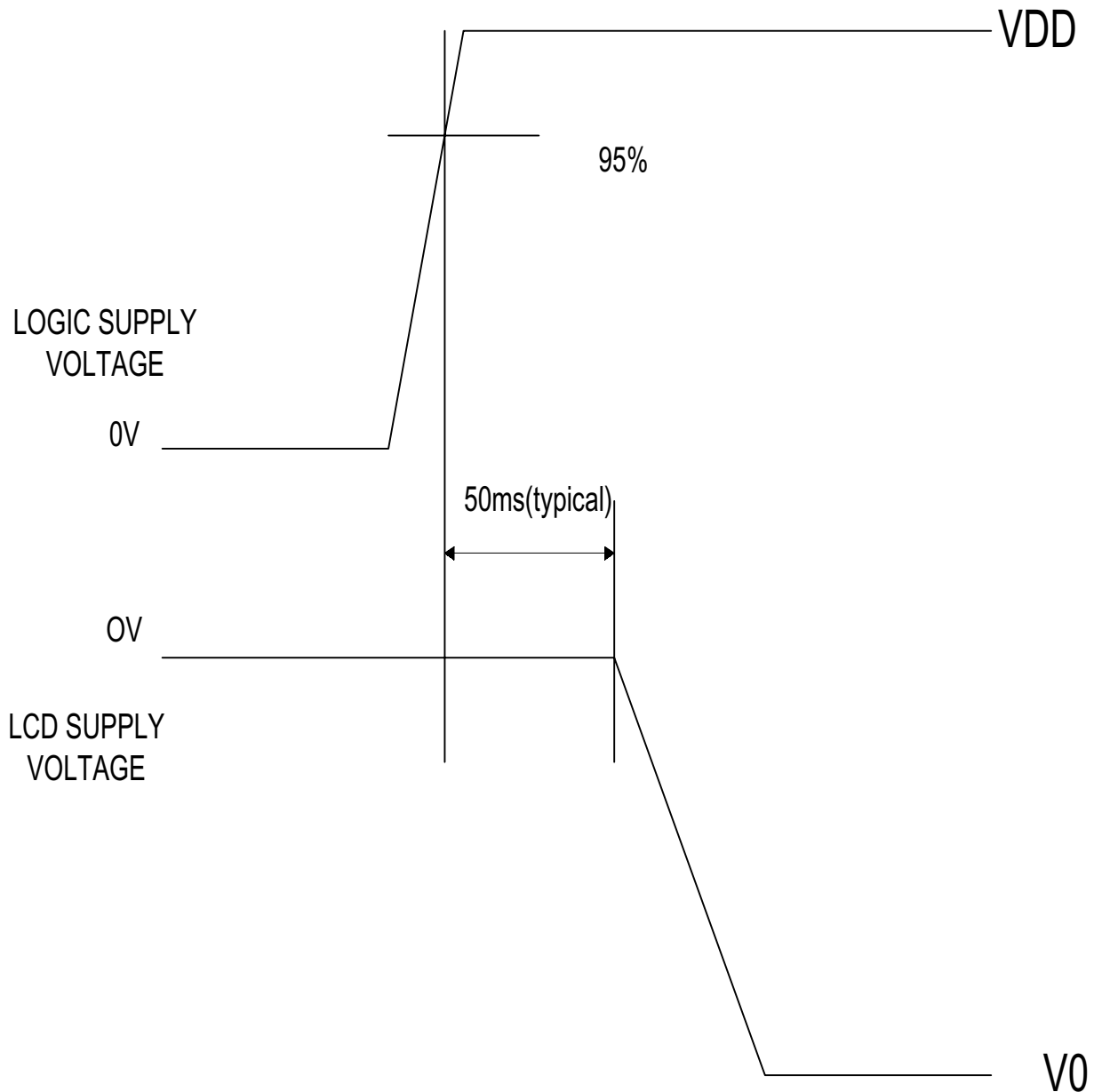

Figure 3: Timing diagram of VDD against V0.

## 6. APPENDIX – LED SPECIFICATIONS

### 1. 极限参数 ABSOLUTE MAXIMUM RATINGS

(除非特别说明,环境温度 Ta=25°C. Unless specified, The Ambient temperature Ta=25°C)

项目 Item	符号 Symbol	条件 Conditions	值 Rating	单位 Unit
* 极限直流正向电流 Absolute maximum forward current	Ifm		25	mA
* 脉冲驱动时极限正向电流 Peak forward current	Ifp	1 msec 脉冲, 1/10 占空比 1 msec Plus 10% Duty Cycle	60	mA
反向电压 Reverse Voltage	Vr		5	V
* 极限功耗 Power dissipation	Pd		75	mW
工作温度 Operating Temperature Range	Topr		-30~+70°C	°C
贮存温度 Storage Temperature Range	Tstg		-40~+80°C	°C

- \* 当工作温度高于 25°C 时, Ifm, Ifp 和 Pd 必须降低; 电流降低率是 -0.36 mA/°C (直流驱动), 或 -0.86 mA/°C (脉冲驱动), 功耗降低率是 -0.75 mW/°C. 产品的工作电流不能大于对应工作温度条件 Ifm 或 Ifp 的 60 %.  
For operation above 25°C, The Ifm Ifp & Pd must be derated, the Current derating is -0.36 mA/°C for DC drive and -0.86 mA/°C for Pulse drive, the Power dissipation is -0.75 mW/°C. The product working current must not more than the 60 % of the Ifm or Ifp according to the working temperature.

### 2. 电. 光特性 ELECTRICAL-OPTICAL CHARACTERISTICS

(除非特别说明,环境温度 Ta=25°C. Unless specified, The Ambient temperature Ta=25°C)

项目 Item	符号 Symbol	最小值 min.	典型值 typ.	最大值 max.	单位 Unit	测定条件 Condition
正向电压 Forward Voltage	Vf	3.1	3.4	3.7	V	If= 20 mA
反向电流 Reverse Current	Ir			15	μA	Vr= 3 V
峰值波长 Peak wave length	λP				nm	If= 20 mA
频谱半宽度 Spectral Line Half width	Δλ				nm	If= 20 mA
* 亮度 Luminance	Lv	54	70		cd/m²	If= 20 mA

- \* 亮度值是 5 个测量点的平均值, 亮度最大值比最小值一般小于 1.5 (最大 1.7).  
使用 BM-7 亮度色度仪测量, 测量光圈 φ 5 mm.

The luminance is the average value of 5 points, and  
The Lvmax./Lvmin. is less than 1.5 Typical (max 1.7).  
The measurement instrument is BM-7 luminance  
Colorimeter. The caperture is φ 5 mm.

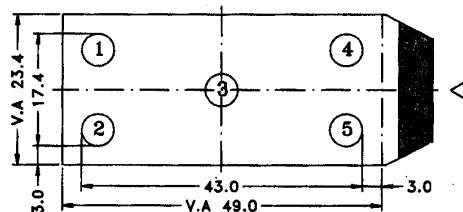

色度坐标见下表:  $\triangle$

Colour Coordinate see the chart:

	Rank B1 Limiting Region				Rank B2 Limiting Region			
X	0.287	0.283	0.330	0.330	0.296	0.287	0.330	0.330
Y	0.295	0.305	0.360	0.339	0.276	0.295	0.339	0.318

注: 色度坐标值公差 $\pm 0.01$

每批出货产品的色度坐标只能在B1区或只能在B2区。

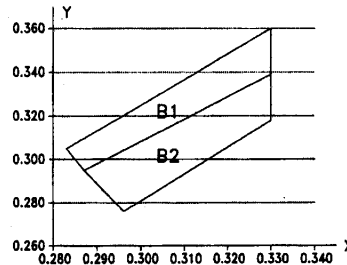

### 3. STATIC ELECTRICITY AND SURGE

- \* Static electricity and surge will damage the LEDs. It is recommended to use a wrist band or anti-electrostatic glove when handling the LEDs.
- \* All devices, equipment and machinery must be properly grounded.
- \* When inspecting own final products on which LEDs were mounted, it is recommended to check also whether the mounted LEDs are damaged by static electricity or not. It is easy to find static-damaged LEDs by light emission test at lower current (below 1mA is recommended). Damaged LEDs will show some unusual characteristics such as leak current remarkably increases, starting forward voltage becomes lower, or the LEDs get unlighted at the low current.

### 4. RECOMMEND CONNECTION OF STATIC-ELECTRICITY RESISTANCE

- \* This circuit diagram is a common ESD protection circuit for all super bright blue, white and green color LED backlight application.

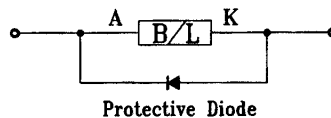

### 5. LED ELECTRICAL CHARACTERISTICS

(1) 正向电流-周围温度  
Forward Current VS. Ambient Temperature

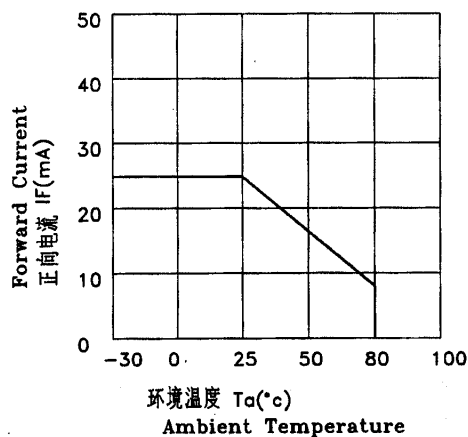

(2) 正向电流-正向电压特性  
Forward Current VS. Forward Voltage

