

# Robust RJ-45 connection systems for harsh environments

IP67 Connectivity  
for Industrial  
Ethernet,  
External  
Datacoms  
and Serial  
Communication

**W** Woodhead

**RJLnxx**  
Harsh-Duty DataCom Solutions



## Physical media

The connectors, receptacles and cabling that provide a pathway between network enabled devices

Specifications	3
Field Attachable and Moulded Connectors	6
Male and Female Moulded Connectors	7
Female Receptacles	8
RJ-Lnxx® Accessories	10

## Ethernet I/O Module

Modules that connect to devices with basic electrical input/output signals, (eg proximity sensors), so that those devices may send and receive data over the network

Ethernet I/O Module	11
---------------------	----

## Ethernet Switches

An OSI layer 2 device, in a star topology network through which all transmissions are sent and intelligently directed to their destination

IP67 Ethernet Switch	12
IP20 Ethernet Switches and Media Converter	13

## Applications

Industrial applications include machine monitoring and control, data acquisition, vision based quality control systems, thermal image monitoring, visual displays, weighing, labelling and bar code scanning within the automotive, machine tool, mechanical handling, food processing, textile, ceramics, marine and petrochemical industries.

In addition to industrial uses, the RJ-Lnxx connector system is ideal for a range of datacoms applications where harsh environmental conditions are a factor. Examples include railways, airport display systems wireless internet, health, stage sound and lighting, military, construction and building management.

All connectors and receptacles can be specified with U/V stable components for external applications

## Features



**Secure, Robust Connection** – Standard RJ-45 connectors are not designed to withstand regular and potentially damaging abuse often experienced in industrial applications. The RJ-Lnxx® threaded, overmoulded design completely protects both male and female RJ-45 components, making it virtually impossible for data to be interrupted by unintentional physical intervention.

**Harsh Environments** – The RJ-Lnxx IP67 rated industrial connector provides protection from ingress of hazards such as water, oil and dust. The PUR or PE jacketed FTP Category 5e cable stands up to aggressive chemical environments often found in severe applications.

**Vibration** – While standard RJ-45 connectors can expect a long life when mounted in a communications panel, due to the inherent 'play' in the design, they cannot withstand significant levels of vibration. On industrial machinery, this may cause the gold plate on the contacts to wear leading to a potential loss of data. The additional threaded coupling on the RJ-Lnxx connector locks the male and female contacts together, thus eliminating the negative effects of contact vibration.

**Electrically Noisy Conditions** – Motors, inverters, transmitters and drives are all potential sources of EMI (electro-magnetic interference). The RJ-Lnxx Category 5e FTP shielded cable enhances data transmission integrity by protecting against the effects of EMI.



Fully enclosed RJ-45 coupling system reduces downtime due to accidental damage or disengagement

Elimination of contact wear due to mechanical vibration

Environmental protection to IP67

Supports 10 Base T, 100 Base TX

Transmission performance to ISO/IEC 11801, EN 50173-1, Category 5e

Available in 568A and 568B wiring configurations

Compatible with standard RJ-45 components

Conforms to IEC 61076-3-111 PAS and proposed IEC 61076-3-106 industrial connector standards

Conforms to IEC 60068-2-6 mechanical shock and vibration standards



**M12 Ethernet** – A range of M12 Ethernet connectivity products will be available from Woodhead. Please contact your local sales office for details.

# The Concept

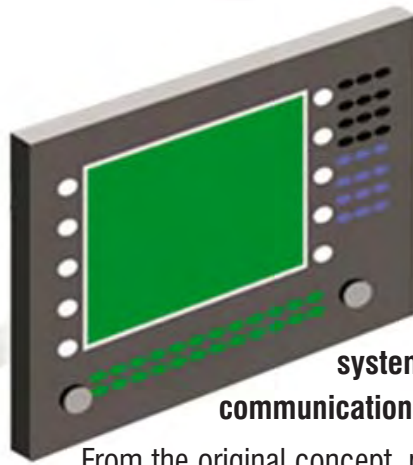

**Designed to extend office communication networks to the factory floor and also to address external harsh Ethernet and datacoms applications, the RJ-Lnxx® robust IP67 rated RJ-45 connectivity system provides a secure and trouble free data communications link for the most arduous of operating environments.**

From the original concept, pioneered by Woodhead in 1999, the RJ-Lnxx system has been continuously developed and now includes the widest range of male/female connector interfaces and accessories plus IP67 rated Ethernet switches and Ethernet I/O modules that save the space and cost of a protective cabinet.

The system comprises:

**Male field attachable connectors** designed to accept standard datacoms shielded (FTP) or unshielded (UTP) cables with either solid or stranded conductor cores.

**Male moulded connectors**, in either single or double-ended (jumper) configuration, with standard or custom cable lengths, manufactured using a wide range of Category 5e cables. Available in combinations of FTP/UTP, solid/stranded conductor cores and PVC/PE/Propex outer jackets to provide the exact cable type for the majority of internal and external applications.

An **in-line interconnect adapter** for joining male connectors.

**Female moulded connectors** for in-line applications and double ended male/female connectors to extend the IP67 data network.

A comprehensive range of **female receptacles** featuring a number of back-end termination options permitting integration into OEM devices and Ethernet/datacoms control panels.

**Male and female closure caps**, with or without retaining lanyard, to provide mating face protection when the connector or receptacle is not in use.

**Wall mounted enclosures** to provide the interface between standard premise wiring and IP67 RJ-Lnxx connectivity.

**IP67 rated Ethernet switches** and **Ethernet I/O modules** that can be mounted directly onto manufacturing equipment, simplifying wiring and network design and eliminating the cost and space associated with protective enclosures.

**When any combination of RJ-Lnxx connectors, receptacles, switches and I/O modules are mated together, the result is an extremely robust interface providing ingress protection to IP67, thus maintaining data integrity at all times.**

In addition to the above IP67 rated products there is a range of IP20 Ethernet switches and copper/fibre media converters for in-cabinet applications where robust connectivity is not required.



The RJ-Lnxx<sup>®</sup> range of connectors achieves an IP67 rating by using a rugged outer shell that fully seals the RJ-45 connector from environmental factors like water, dirt, dust and oil. Field-attachable male connectors provides maximum flexibility by allowing the machine / system builder to affix the necessary cable length themselves when either the cable length is unknown or the connector needs to be attached after cable installation for example through ducting or conduit.

The pre-wired male and female moulded connectors totally eliminate any possibility of termination errors during on-site installation and combine great mechanical strength with IP67 ingress protection to provide maximum data integrity under the most arduous of operating conditions. Male connectors mate directly with the whole range of female receptacles and also provide the data link between the RJ-Lnxx IP67 Ethernet switch, Ethernet I/O module and the datacoms network. The female connectors are used on equipment where there is limited room to fit a female receptacle and are also used to extend network length in male/female connector configurations.

## Cable

To ensure the connectors can be used in a wide range of industrial and harsh external applications, Woodhead has developed a number of Category 5e datacoms cables:

- Polyurethane (PUR) jacketed cables are the natural choice for factory environments, providing maximum resistance to oil, grease and general contaminants encountered on the shop floor.  
RJCAB-V cable has solid conductors, is suitable for fixed applications and allows transmission distances of up to 100metres.  
RJCAB-C cable has a stranded core construction and is suitable where the connector is subject to limited or infrequent movement. Transmission distances are limited to 30metres due to the inferior attenuation properties of stranded conductors. Both cables provide a good degree of EMC protection due to the FTP foil screen construction.
- Two cables are available for external applications and for areas within factory environments where equipment washdown is a regular occurrence such as food processing. Featuring a rugged black Polyethylene (PE) outer jacket that resists cutting or ripping, the cables are waterproof and U/V stable against sunlight.  
RJCAB-X has solid core unshielded (UTP) construction and is particularly suited to fixed external applications. RJCAB-Y provides additional EMC and physical protection due to the addition of a foil (FTP) screen. Both cables are suitable for transmission lengths of up to 100m.
- RJCAB-P has been created for the most severe of uses. Featuring a Kevlar weave protecting the stranded flexible conductors and a thick waterproof PUR outer jacket, the cable is particularly suited for outdoor mobile applications where there is a risk of crushing standard cables and losing data communications as a result. Recommended maximum transmission length is 30metres due to the stranded core construction.
- For repetitive movement applications such as dragchains, RJCAB-D should be used.

In addition to being fitted to the pre-terminated moulded connectors, all the above cables can be supplied in 50m or 305m reels for use either with field attachable connectors or for applications where industrial grade data cable without connectors is required, see page 10.



## Male Field Attachable Connectors



Fitted with standard shielded Cat 5e male plugs  
Available for both solid core and stranded (patch) core cable  
Accepts 24/26 AWG/0.50mm FTP/UTP datacoms cable with outer jacket O/D from 2.5mm – 6.5mm  
Uses standard AMP style shielded RJ-45 crimp tools  
10/100 Base TX, 568A, 568B compatible  
Ingress protection to IP67, Cat 5e rated

Part Number	Description
ENSAM315	Field attachable connector for solid core FTP/UTP cable
ENQAM315	Field attachable connector for stranded (patch) core FTP/UTP cable
RJ56-0200-01	Replacement shielded male plug for ENSAM315
RJ56-0200-02	Replacement shielded male plug for ENQAM315

# Male and Female Moulded Connectors



The RJ-Lnxx® range of moulded connectors are available in a number of head and cable configurations to suit the majority of industrial and commercial applications. Being pre-wired and individually tested, connectivity is guaranteed on installation and also eliminates the cost, complexity and potential wiring errors associated with on-site termination.

Industrial male connectors provide a robust data connection when mated to the range of RJ-Lnxx IP67 rated female receptacles, Ethernet switches, Ethernet I/O modules and closure caps.

Industrial female connectors are used where either there is limited cabinet space for female receptacles or there is a need to extend the data link in hostile environments as part of a male/female double ended connector. Again, IP67 ingress protection is assured when mated with RJ-Lnxx male connectors or closure caps.

The two principle datacoms wire maps are available as standard:

10/100 Base TX 568A – 4 pair, 8 wire – Example part number ENV2115M020

10/100 Base TX 568B – 4 pair, 8 wire – Example part number ENV3115M020







Where necessary, 'pure Ethernet' 2 pair, 4 wire connectors (Pin wiring 1,2,3,6) can be specified as an option eg. ENV1115M020, however 4 pair, 8 wire versions provide maximum data connectivity potential and are therefore strongly recommended.

In conjunction with the cable descriptions opposite, use the cable selector guide below to choose the correct cable by application

Cable ref	Description	Typical part no.	Transmission distance		Flexible Applications	EMC	Oil/Dirt	External Water, U/V
			100M	30M				
RJCAB- <b>V</b>	FTP/Solid Conductor/ PUR Jacket	ENV <b>V</b> 3115M020	•			•	•	
RJCAB- <b>C</b>	FTP/Stranded Conductor/ PUR Jacket	ENC <b>C</b> 3115M020		•	•	•	•	
RJCAB- <b>D</b>	FTP/Stranded Conductor/ PUR Jacket	END <b>D</b> 3115M020		•	•	•	•	
RJCAB- <b>P</b>	FTP/Stranded Conductor/ PUR Jacket/Kevlar	ENP <b>P</b> 3115M020		•	•	•	•	•
RJCAB- <b>X</b>	UTP/Solid Conductor/ PE Jacket	ENX <b>X</b> 3115M020	•					•
RJCAB- <b>Y</b>	FTP/Solid Conductor/ Pe Jacket	ENY <b>Y</b> 3115M020	•			•		•
The following UL/CSA cables are available as an option								
RJCAB- <b>S</b>	FTP/Solid Conductor/ PUR Jacket	ENS <b>S</b> 3115M020	•			•	•	
RJCAB- <b>Q</b>	UTP/Stranded Conductor/ PVC Jacket	ENQ <b>Q</b> 3115M020		•	•			

## Connector Head Configurations

The RJ-Lnxx moulded connector range comprises male moulded connectors, female moulded connectors and standard RJ-45 male connectors which are available in the following configurations, with other variations available on request. The table below details the range of connector configuration available as standard, using **V** cable as an example, this being the preferred cable choice for the majority of applications.

	Length	10/100 BaseTX, 568A	10/100 BaseTX, 568B
<b>Industrial Male – Free End</b> 	1m	ENV2105M010	ENV3105M010
	2m	ENV2105M020	ENV3105M020
	3m	ENV2105M030	ENV3105M030
	4m	ENV2105M040	ENV3105M040
	5m	ENV2105M050	ENV3105M050
<b>Industrial Male – Industrial Male</b> 	1m	ENV2115M010	ENV3115M010
	2m	ENV2115M020	ENV3115M020
	3m	ENV2115M030	ENV3115M030
	4m	ENV2115M040	ENV3115M040
	5m	ENV2115M050	ENV3115M050
<b>Industrial Male – Standard Male</b> 	1m	ENV2135M010	ENV3135M010
	2m	ENV2135M020	ENV3135M020
	3m	ENV2135M030	ENV3135M030
	4m	ENV2135M040	ENV3135M040
	5m	ENV2135M050	ENV3135M050
<b>Industrial Female – Free End</b> 	1m	ENV2205M010	ENV3205M010
	2m	ENV2205M020	ENV3205M020
	3m	ENV2205M030	ENV3205M030
	4m	ENV2205M040	ENV3205M040
	5m	ENV2205M050	ENV3205M050
<b>Industrial Female – Industrial Female</b> 	1m	ENV2225M010	ENV3225M010
	2m	ENV2225M020	ENV3225M020
	3m	ENV2225M030	ENV3225M030
	4m	ENV2225M040	ENV3225M040
	5m	ENV2225M050	ENV3225M050
<b>Industrial Female – Industrial Male</b> 	1m	ENV2215M010	ENV3215M010
	2m	ENV2215M020	ENV3215M020
	3m	ENV2215M030	ENV3215M030
	4m	ENV2215M040	ENV3215M040
	5m	ENV2215M050	ENV3215M050

Lengths above 5 metres are available in multiples of 5m. e.g. ENV2135M100 (10M), ENV2135M250 (25m)



The RJ-Lnxx<sup>®</sup> line offers several different types of receptacles designed for a variety of applications. Suitable for OEMs wanting to incorporate a robust RJ-45 connector into equipment for either Ethernet or serial communication, for bringing robust Ethernet/datacoms cabling to an industrial enclosure, or for a datacoms installer extending office networks down to the factory floor, there is an appropriate RJ-Lnxx receptacle available.

Importantly, all receptacles are compatible with commercial RJ-45 connectors, enabling one solution for both harsh and benign environments. Receptacles come complete with sealing gasket and lock nut. They feature a hexagonal flange and location key for precise orientation onto panel or device. All are Cat 5e compliant except ENPR1FF5 (Cat 5) are fully shielded and are available with optional earth straps for grounding to the panel.

The receptacle line is complemented by IP67 closure caps providing protection when the receptacle is not in use, for example in non-continuous data transfer applications.

## PC Board Receptacles

Available in three back terminations to provide maximum flexibility when mounting onto panels or OEM devices. From the basic PCB version which allows the user to terminate cable as required, to versions pre-wired with 305mm or one metre lengths of shielded Cat 5e solid core PUR jacketed cable, either with free ends or terminated with a shielded male RJ-45 plug permitting direct connection to an Ethernet/datacoms device inside the panel. Choice of 10/100 BaseTX/568A or 10/100 BaseTX/568B wiring on cable versions.

## PCB Termination

Part Number	Description
ENSR1FB5	Receptacle, PC Board Terminated

## PCB + Cable Termination

Part Number	Description
ENSR2FB5C305	Receptacle, 305mm, 10/100 BaseTX, 568A
ENSR3FB5C305	Receptacle, 305mm, 10/100 BaseTX, 568B
ENSR2FB5M010	Receptacle, 1.0m, 10/100 BaseTX, 568A
ENSR3FB5M010	Receptacle, 1.0m, 10/100 BaseTX, 568B

## PCB + Cable + Male RJ-45 Plug Termination

Part Number	Description
ENSP2F5C305	Receptacle, 305mm, Plug, 10/100 BaseTX, 568A
ENSP3F5C305	Receptacle, 305mm, Plug, 10/100 BaseTX, 568B
ENSP2F5M010	Receptacle, 1.0m, Plug, 10/100 BaseTX, 568A
ENSP3F5M010	Receptacle, 1.0m, Plug, 10/100 BaseTX, 568B

## Through Panel Receptacles

These receptacles have shielded female jacks fitted to the PCB. Connection is made to the device inside the panel with a standard male patch cord or jumper. The through panel receptacles are particularly useful when internal cable lengths are either unknown or varied. They are available in two versions. RJ-45 for use with the range of RJ-Lnxx field attachable and moulded male connectors. Also with 6 pole RJ-12 female jacks (both front face and fitted to PCB) for use with standard RJ-12 connectors. The front face of both receptacles can be protected by IP67 closure caps when not in use.

Part Number	Description
ENSP1F5	Through Panel Receptacle, RJ-45 – Cat 5e
ENSP6F5	Through Panel Receptacle, RJ-12 – Telecoms

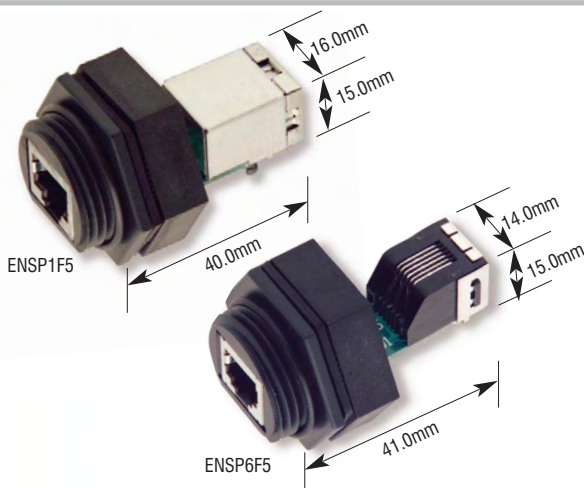
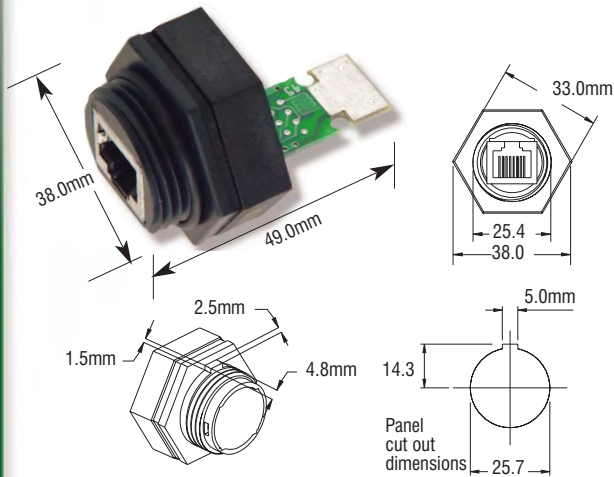

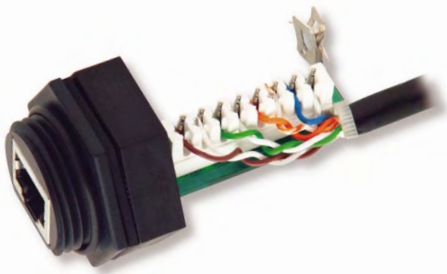

## Punchdown Receptacles

These receptacles have been designed to permit termination directly onto cable without the need for stripping and soldering conductor cores. Insulated cores are simply laid across the terminal blocks and are IDC terminated in seconds using punchdown hand tools freely available from any datacoms distributor. The receptacles can be specified with either 'Krone' or '110' style terminal blocks, come complete with earthing post for FTP cable drain wire, cable tie and 568B/568A wiring card. Receptacles are shielded and Category 5e compliant.

**Legend**

- BL/W Blue/White
- BL Blue
- O/W Orange/White
- O Orange
- G/W Green/White
- G Green
- BR/W Brown/White
- BR Brown

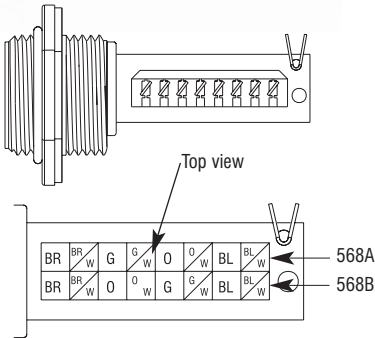

**Part Number**

**Description**

ENDR3FB5-K	Receptacle, Krone Punchdown IDC termination
ENDR3FB5-110	Receptacle, 110 Punchdown IDC termination

## Earth Strap Versions



For allowing the receptacle shielded components to be grounded directly to the mounting panel. Available with 1.13mm<sup>2</sup> high grade tinned copper braided earth lead with 3.5mm ring terminal. Earth strap length 10cm ENSR1FB5, ENSP1F5 and 8cm for all other versions. Specify earth strap version by adding – ESP to the standard part number. Some typical examples:

**Part Number**

**Description**

ENSP1FB5-ESP	Through Panel Receptacle, RJ-45, earth strap
ENSR1FB5-ESP	Receptacle, PC Board Terminated, earth strap
ENSP2F5C305-ESP	Receptacle, 305mm, Plug, earth strap, 10/100, 568A
ENDR3FB5-K-ESP	Receptacle, Krone Punchdown IDC termination, earth strap

## Direct PCB Mount Receptacle

Due to the front lock nut design this receptacle is ideal for OEM applications where the receptacle needs to be terminated directly onto a PCB which is then mounted into the device housing. The short overall depth from front face to PCB pins makes the receptacle particularly suitable where internal housing space is at a premium. Features a shielded female jack and earthing clips to assure continuity of shielding to attached PCB.

**Part Number**

**Description**

ENPR1FF5	Receptacle, Direct PCB Mount, Front Lock Nut, Category 5.
----------	-----------------------------------------------------------

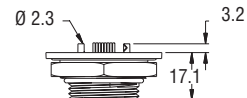
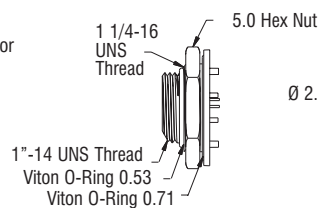
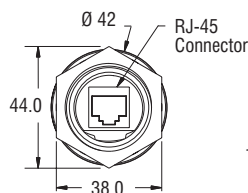
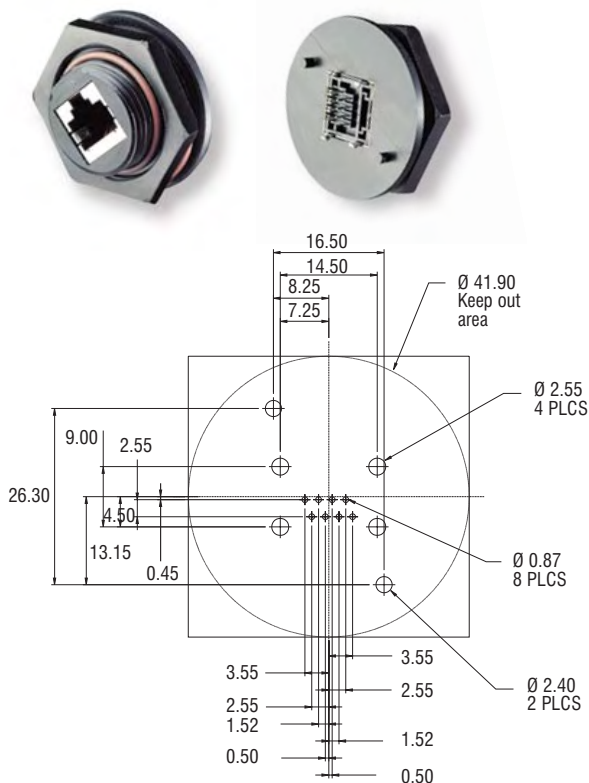





**IP67 Receptacle Closure Caps**

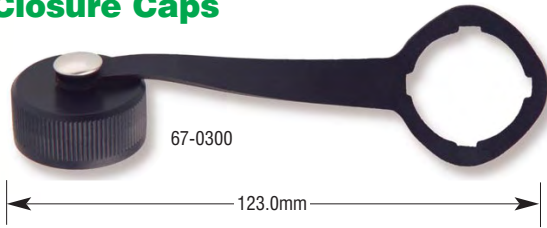

To protect the front face of receptacles or female moulded connectors when not in use, for example in non-continuous data transfer applications or when temporarily disconnected from RJ-Lnxx or standard RJ-45 male connectors such as in portable/mobile applications. The 4 position lanyard keys allow the closure cap to always drop vertically regardless of receptacle jack orientation.

Part Number	Description
65-0300	Closure Cap only (material Nylon 6, glass filled)
67-0300	Captive Closure Cap with integral 'rubberised lanyard and stainless steel retaining clip for attaching to receptacles. Waterproof and U/V stable for external applications.

**IP67 Male Connector Closure**



To protect the front face of field attachable or male moulded connectors when not in use, for example in non-continuous data transfer applications or when temporarily disconnected from RJ-Lnxx receptacles or female moulded connectors such as in portable/mobile applications.

Part Number	Description
65-0301	Closure Cap only (material Delrin)
67-0301	Captive Closure Cap with integral 'rubberised lanyard and stainless steel retaining clip for attaching to connectors. Waterproof and U/V stable for external applications.

**IP67 In-Line Interconnect**



Allows either moulded or field attachable male connectors to be mated together, extending overall system length.

Part Number	Description
RJBG16821	In-line Interconnect

**IP67 Threaded Interconnect**



Allows either moulded or field attachable male connectors to be mated together, extending overall system length. Two M40 nylon lock nuts and threaded barrel allow the interconnect to be positively fixed to a panel or enclosure wall.

Part Number	Description
RJBG17946	Threaded Interconnect

**Backend Receptacle Cover**

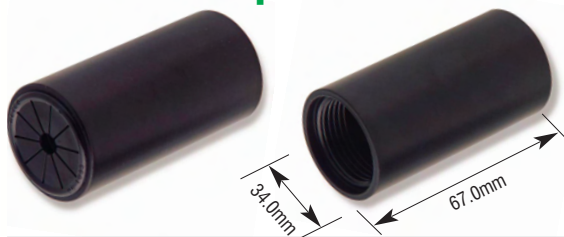

Provides environmental protection from dirt and debris and additional structural support to the back of receptacles. Particularly useful where the inside of enclosures are regularly accessed for maintenance. The slotted design enables a cable and RJ-45 to exit the cover and the threaded front end replaces the receptacle lock nut for panel mounting.

Part Number	Description
RJBG17756	Backend Receptacle Cover

**Cables**

The range of RJ-Lnxx cables are also available in 50m or 305m reel sizes. Specifically designed for industrial or harsh commercial applications they perform a key role in maintaining datacoms integrity under arduous operating conditions.

Cable ref	Description	Application
RJCAB-V-500/RJCAB-V-3050	FTP/Solid Conductor/ PUR Jacket	Oil, Dirt, EMC, 100m
RJCAB-C-500/RJCAB-C-3050	FTP/Stranded Conductor/ PUR Jacket	Oil, Dirt, EMC, 30m, light flexing
RJCAB-D-500/RJCAB-D-3050	FTP/Stranded Conductor/ PUR Jacket	Oil, Dirt, EMC, 30m, repeated flexing
RJCAB-P-500/RJCAB-P-3050	FTP/Stranded Conductor/ PUR Jacket	Oil, Dirt, EMC, 30m, crush resistant (Kevlar weave)
RJCAB-X-500/RJCAB-X-3050	UTP/Solid Conductor/ PE Jacket	External, water resistant, U/V stable, 100m
RJCAB-Y-500/RJCAB-Y-3050	FTP/Solid Conductor/ PE Jacket	External, water resistant, U/V stable, EMC, 100m

**Wall Boxes:** A range of wall boxes to accommodate RJ-Lnxx receptacles allows standard datacoms cabling to be connected to IP67 RJ-Lnxx components. Please contact Woodhead Connectivity for further details or to discuss specific requirements.



## Cable Type

Cable Type FTP, CAT5E

Cable Type UTP, CAT5E

Relevant Standards – IEC 11801, IEC 1156

## Cable Construction

Insulated Core – Conductor 24AWG solid copper 0.53 +- 0.02mm

Insulated Core – Conductor 26AWG stranded copper 0.48+- 0.02mm

Insulation – High density polyethylene 1.05 +- 0.05mm. Nominal wall RT 0.27mm

Insulation – High density polyethylene 0.90 +- 0.05mm. Nominal wall RT 0.21mm

Cable pairs – 2 cores twisted together with staggered lays 2.10 +- 0.10mm

Cable pairs – 2 cores twisted together with staggered lays 1.80 +- 0.10mm

Final Construction – 4 pairs 4.50 +- 0.20mm, polyester binder over pairs

Final Construction – 4 pairs 3.90 +- 0.20mm, polyester binder over pairs

Outer jacket, Polyurethane, Black. Outer diameter +- 0.20mm

Outer jacket, Polyethelene, Black. Outer diameter +- 0.20mm

Screen – Aluminium/Polyester tape with 0.50mm tinned drain wire

Minimum Bend Radius – (12 times outer jacket diameter) mm

Weight Kg/km

Operating Temperature -40°C – +65°C

Operating Temperature -40°C – +80°C

Operating Temperature -70°C – +80°C

## Attenuation in dB/100m Max / NEXT dB Min @ 20C at:

	V	C	P	X	Y
1 MHz	2.1 / 68	3.1 / 68	3.15 / 62	2.1 / 68	2.1 / 68
4 MHz	4.3 / 59	5.7 / 59	6.45 / 53	4.3 / 59	4.3 / 59
10 MHz	6.6 / 53	8.6 / 53	9.9 / 47	6.6 / 53	6.6 / 53
16 MHz	8.2 / 50	10.8 / 50	12.3 / 44	8.2 / 50	8.2 / 50
20 MHz	9.2 / 48	12.5 / 48	13.8 / 42	9.2 / 48	9.2 / 48
31.25 MHz	11.8 / 45	15.5 / 46	17.7 / 40	11.8 / 45	11.8 / 45
62.5 MHz	17.1 / 41	22.0 / 41	25.6 / 35	17.1 / 41	17.1 / 41
100 MHz	22.0 / 38	27.5 / 38	33.0 / 32	22.0 / 38	22.0 / 38
Impedence (Ohms) From 1 – 100 MHz	100Ω ± 15Ω	100Ω ± 15Ω	100Ω ± 15Ω	100Ω ± 15Ω	100Ω ± 15Ω
Capacitance pF/m Nom	56	52	46	52	56
Velocity of Propagation % Nom	66%	66%	67%	66%	66%
d.c Insulation Resistance, Mohms km Min	150	150	150	150	150
Conductor Loop Resistance, Ohms/100m Max	30	30	30	30	30
Dialecreic strength for 1 minute, V a.c.	700	700	700	700	700

## Wiring Configurations

### T568B (258A)

(RJ-Lnxx® ENV 3 xxx)

Pin No.	Pair ID	Colour
1	T2	Whi/Org
2	R2	Org/Whi
3	T3	Whi/Grn
4	R1	Blu/Whi
5	T1	Whi/Blu
6	R3	Grn/Whi
7	T4	Whi/Brn
8	R4	Brn/Whi

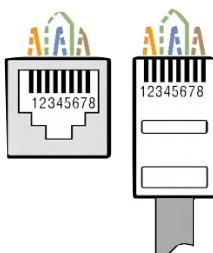

### T568A

(RJ-Lnxx ENV 2 xxx)

Pin No.	Pair ID	Colour
1	T3	Whi/Grn
2	R3	Grn/Whi
3	T2	Whi/Org
4	R1	Blu/Whi
5	T1	Whi/Blu
6	R2	Org/Whi
7	T4	Whi/Brn
8	R4	Brn/Whi

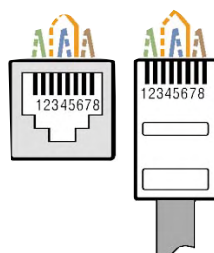

### 10Base-T (802.3)

(RJ-Lnxx ENV 1 xxx)

Pin No.	Pair ID	Colour
1	T1	Whi/Blu
2	R1	Blu/Whi
3	T2	Whi/Org
6	R2	Org/Whi

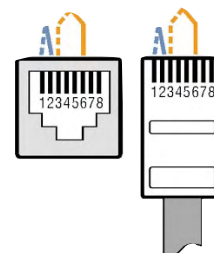

## Connector/Receptacle Material

O-Ring Material	Viton
Insert / Coupling Nut / Receptacle Shell Material	ABS.
Connector / Receptacle mating thread	1"-14 UNS
Receptacle Panel Mount / Locknut Thread	1"-14 UNS
Overmould Material	Polyurethane
Operating Temperature	-20C – +80C
Shock and Vibration	To IEC 60068-2-6
Environmental Rating	To IP67
Tightening Torque, Connector to Receptacle	0.7 Nm
Mounting Torque, Receptacle to Panel	2.0 Nm

## RJ-45 Plugs & Jacks

Contact base material	Copper alloy with 30µ inches gold alloy
Underplating	2,5 microns nickel
Body Material	Polycarbonate
Mating Cycles	250 minimum
Current rating	1.5 Amp
Voltage rating	125VDC

## U/V Stable Components

All connectors and receptacles can be specified with U/V stable components for external applications by adding - V to the base part number. Typical examples:

ENSAM315 - V	Male Field Attachable Connector, U/V Stable
ENV2105M020 - V	Male Moulded Connector, U/V Stable
ENSR1FB5 - V	PCB Termination Receptacle, U/V Stable



# Ethernet I/O Module

Ethernet for control on the manufacturing floor

## Features

- Environmentally sealed (IP67) for use in harsh environments.
- Mount directly onto machine to optimise installation layout and eliminate cost & space of a protective enclosure.
- 8 input and 8 output points per module.
- Supports the EtherNet/IP application layer.
- Static or dynamic IP address configuration.
- 10/100 Mbps auto-sensing capability.
- Diagnostic LEDs provide status information at a glance.
- Built-in Web server for remote monitoring and configuration.

Recent advances in technology now mean that Ethernet transmission performance can now achieve levels that are acceptable in all but the most extreme time-dependent applications. As a result it is now possible to use Ethernet down to I/O level in many situations and the Ethernet I/O module from Woodhead Connectivity facilitates this by maintaining an IP67 environmental protection rating from control cabinet to sensor or actuator providing the user with a number of operating advantages.

- **Consolidate networks:** With Ethernet frequently operating at controller level on the factory floor, extending it to the device level unifies the communications network leading to more efficient support, increased uptime and reduced cost
- **Increase throughput:** Ethernet can run at speeds of 100 Mbps. While many associated factors affect network speed, Ethernet increases the potential to turn faster data transmissions into a productivity gain
- **Contain costs:** The ability to use commonly available tools such as Web browsers, Active X, C++, and others, to design low cost, highly scaleable control and data collection systems makes using industrial Ethernet the economical choice in many circumstances.

The Woodhead solution uses the EtherNet/IP application layer, which is similar to the protocol used in other standard open industrial networks such as DeviceNet and ControlNet. Following traditional industrial fieldbus practices, standard M12 connectors from sensing devices or actuators plug directly into the module.

With an IP67 rating, tolerance to temperature extremes and resistance to vibration, the RJ-Lnxx<sup>®</sup> I/O module is an "enclosureless" device intended for use on the factory floor, close to sensors and actuators. Advanced network features such as 10/100 Mbps auto-sensing, Web server capability, and a flexible IP address setup method, make configuration and operation simple.

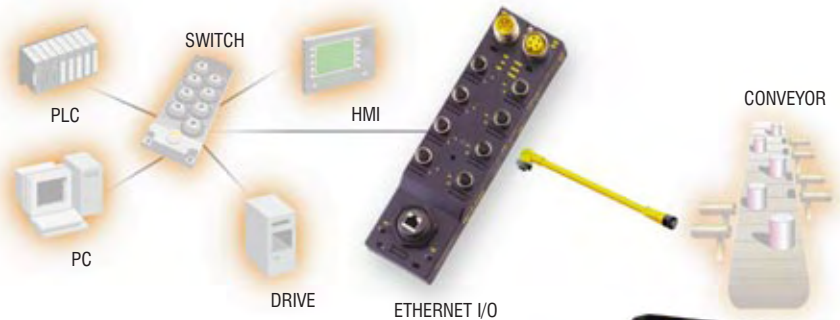

## Specifications

### Power, Input/Output:

<b>Input Power:</b>	11 – 25 VDC
<b>Internal Current Consumption:</b>	160 mA
<b>Input Circuits (8):</b>	Non isolated, Sinking, 4 wire sensors or Dry Contacts
<b>Input Voltage:</b>	11 – 25V
<b>On State Input Current:</b>	100mA max per input, 8 mA nominal@ 24 VDC
<b>Off State Input Current:</b>	300 micro amps
<b>Electrical Protection:</b>	Current limited to 100 mA
<b>Output Circuits (8):</b>	Non isolated, sourcing
<b>On State Output Voltage:</b>	11 VDC min., 24 VDC nominal, 25 VDC max.
<b>Output On State Current:</b>	1 A/Output with Electronic Overcurrent protection
<b>Off State Output Current:</b>	0.5 mA maximum leakage
<b>Output Fault Action:</b>	Configurable for Off or Hold Last State

**Maximum Switching Frequency:** <100Hz

### Network Setting:

<b>Communications Rate:</b>	10/100 Mbs auto-sensing, autodetecting, full duplex.
<b>Protocol Capabilities:</b>	Ethernet/IP 1.0
<b>Addressing Capabilities:</b>	BootP (default), DHCP, static
<b>Diagnostics and Administration:</b>	Web Based interface.
<b>Firmware Updating:</b>	Ethernet via Web Administration Utility

### Mechanical/Environmental:

<b>Operating Temperature:</b>	0° to 70C°
<b>Storage Temperature:</b>	-40° to 85C°
<b>Humidity:</b>	5 – 95% RH non-condensing
<b>Power Connection:</b>	4 Pole Mini Change 104 Series
<b>Network Connection:</b>	RJ-Lnxx IP67 Industrial Male Connector
<b>Input/Output Connectors:</b>	8 x Micro Change M12, 4 wires
<b>Enclosure Rating:</b>	IP67, NEMA 6P
<b>Vibration:</b>	MIL-STD-202F, Method 204D, Condition A
<b>Mechanical Shock:</b>	MIL-STD-202F, Method 21313, Condition B
<b>Thermal Shock:</b>	MIL-STD-1344A

### Part Number

#### TEN-888-R18-05

Part Number	Description
TEN-888-R18-05	IP67 rated Ethernet I/O Module
104000E04M050	DC Power input connector, 5m
104006E04M050	DC Power output connector, 5m
1A4000-34	DC Power input connector, field attachable
1A4006-34	DC Power output connector, field attachable
BG12103	Closure Cap for unused M12 ports

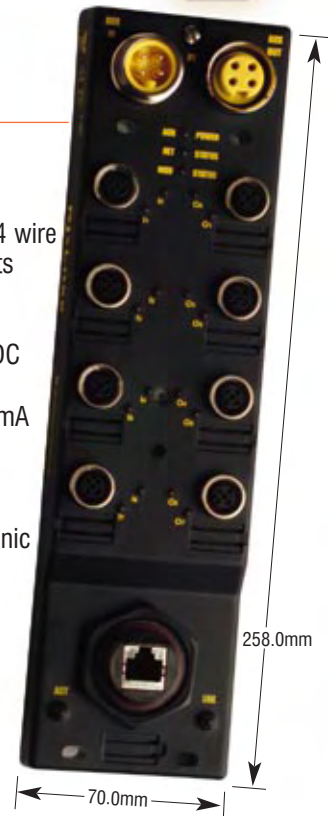

# IP67 Ethernet Switch

## Features

- IP67 protection for use in harsh environments
- Vibration resistance to IEC68-2-6
- Extended temperature ranges -40 C to +80C
- Mount directly onto machine to optimise installation layout and eliminate cost & space of a protective enclosure
- 10/100 Mbps auto-negotiation enables devices that different speeds to reside on same subnet
- Store & forward switch with address auto-learning enhances bandwidth efficiency, aiding determinism for control applications
- Full duplex capability with 1.4Gbps total bandwidth
- Auto-programming for simplified set up.

Although Ethernet switches, rather than repeater hubs, are necessary to ensure time critical, control related data is reliably delivered; most are not designed to withstand the harsh environmental conditions found in industrial applications.

The machine mount switch ENHSAURR8 can be fitted directly onto automation equipment or building infrastructure, its unique IP67 rating and robust, vibration resistant construction eliminating the cost and space of a protective enclosure. The IP67 rating is achieved by using the RJ-Lnxx® range of moulded or field attachable connectors, with unused ports being protected by closure caps 65-0300. Standard RJ-45 patch cords can also be used when the IP67 rating is not required. Power is provided to the switch via a choice of IP68 rated connectors from the 104000 or 104001 series Brad Harrison Mini-Change™ range. See separate catalogue for full details.

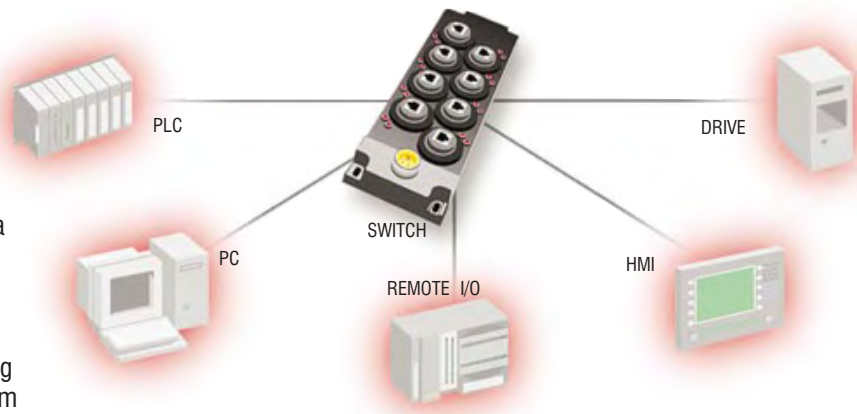

## Specifications

### Electrical:

<b>Required Power:</b>	10 – 30 V DC
<b>Power Consumption:</b>	1.9 Watts Typical
<b>Network Isolation:</b>	1200V RMS for 1 min.

### Environmental/Mechanical:

<b>Operating Temperature:</b>	-40C to +80C
<b>Humidity:</b>	5 to 95% (non-condensing)
<b>Power Connection:</b>	4 pole mini-change connector
<b>Environmental Rating:</b>	IP67 when mated with RJ-Lnxx connectors or closure caps
<b>Electrical Safety:</b>	UL 508
<b>Hazardous Location:</b>	UL 1604, CSA 22.2/213 (Class 1, Div.2)
<b>EMI Emissions:</b>	FCC Part 15, Class B
<b>EMC Immunity:</b>	EN61326A
<b>Vibration Resistance:</b>	To IEC68-2-6
<b>Weight:</b>	750g

### Network:

<b>Ports:</b>	Eight 10/100 Base-T(x), Shielded RJ-45
<b>Ethernet Standards:</b>	IEE1E 802.3, 802.3U, 802.3X
<b>Ethernet Protocols:</b>	All standard IEEE 802.3 protocols
<b>Speed per Port:</b>	10 or 100Mbps (half duplex) 20 or 200Mbps (full duplex)
<b>Buffers:</b>	1024,128 Byte buffers available
<b>Broadcast Storm Protection Broadcasts:</b>	Limited to 25% of available bandwidth
<b>Flow Control:</b>	Supported for both transmit and receive
<b>Back Pressure Function:</b>	Inhibit stations from transmitting
<b>Total Bandwidth:</b>	1.4Gbps

### Part Number

Part Number	Description
<b>ENHSAURR8</b>	<b>Active Switch, Unmanaged, IP67</b>
104001E04M050	Power Connector, Right Angled, 5m
65-0300	Closure Cap for unused RJ45 ports





# IP20 Ethernet Switches and Media Converter

For industrial and harsh commercial environments where the need for IP 67 connectivity is not required, Ethernet switching components can be housed in a protective controls enclosure. However, the vibration and temperature operating ranges offered by standard datacoms switches and media converters are often not sufficient to perform reliably in many applications leading to the risk of data loss, production or system downtime, and the need for often costly repair and maintenance.

The range of Woodhead IP20 DIN rail mount Ethernet switches and copper to fibre media converter have been designed to provide reliable performance while being subjected to extremes of temperature and vibration. Where an IP67 rated connection is required, external Ethernet enabled field devices or other enclosures can be connected to the switch by fitting one of the range of RJ-Lnxx bulkhead receptacles to the enclosure wall. Woodhead's RJ-45 and fibre optic connectors complete the connectivity package.

## IP20 Ethernet Switches

Designed for standard DIN 50022 rail or screw mounting for quick, simple installation in an industrial enclosure, the switches are available in both 5 and 9 port versions. The dedicated uplink port can be specified for use with either copper (RJ-45) or fibre (SC) duplex connectors to suit network design. An extended temperature operating range of -40°C to 85°C allows use in extreme conditions, without the need for costly climate controls. The switches are also Class 1, Div2 rated for use in hazardous environments. Unmanaged Store & forward switch with address auto learning and 10/100 auto-negotiation enhances bandwidth efficiency, aiding determinism for control applications. No programming required allowing the switches to be installed and carrying data in minutes.

## IP20 Media Converter

Where it is uneconomic or impractical to install a complete fibre optic network, the RJ-Lnxx Media Converter enables a fiber backbone to be run into the industrial enclosure by providing an interface to a local copper network. This DIN rail mount unit features one fibre (SC) and two copper (RJ-45) ports and is designed to withstand the extremes of temperature and vibration often found in an industrial environment.

## Specifications

### Electrical:

- Required Power:** 10 – 30 V DC
- Power Consumption:** 1.9 Watts Typical
- Network Isolation:** 1200V RMS for 1 min.

### Environmental/Mechanical:

- Operating Temperature:** -40°C to +85°C
- Humidity:** 5 to 95% (non-condensing)
- Power Connection:** 3 pole screw terminal
- Environmental Rating:** IP20
- Electrical Safety:** UL 508
- Hazardous Location:** UL 1604, CSA 22.2/213 (Class 1, Div.2)
- EMI Emissions:** FCC Part 15, Class B
- EMC Immunity:** EN61326-1
- Vibration Resistance:** IEC68-2-6

### Network:

- Copper Ports:** Shielded RJ-45, 10/100BaseT(X) autonegotiate
- Fibre Port:** Multi-Mode SC, 100BaseFX, 1300 nm centre
- Ethernet Standards:** IEEE 802.3, 802.3U, 802.3X
- Ethernet Protocols:** All standard IEEE 802.3 protocols
- Speed per Port:** 10 or 100Mbps (half duplex)  
20 or 200Mbps (full duplex)
- Buffers:** 1024,128 Byte buffers available
- Broadcast Storm Protection:** Broadcasts limited to 25% of available bandwidth
- Flow Control:** Supported for both transmit and receive
- Back Pressure Function:** Inhibit stations from transmitting
- Total Bandwidth:** 1.4Gbps

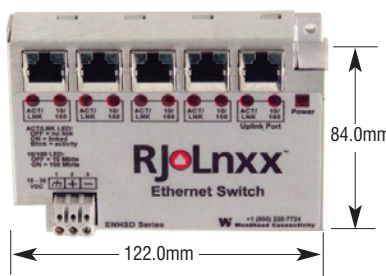

**Part Number Description**  
**ENHSDURR5** Ethernet Switch,  
5 x RJ-45 Ports

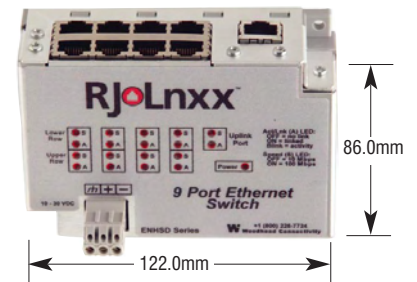

**Part Number Description**  
**ENHSDURR9** Ethernet Switch,  
9 x RJ-45 Ports

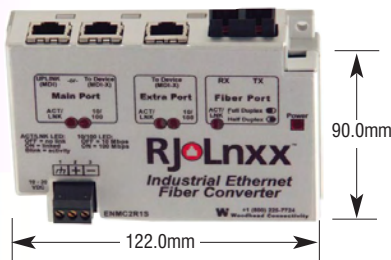

**Part Number Description**  
**ENMC2R15** Media Connector,  
3 x RJ-45 Ports,  
1 x Duplex SC Port

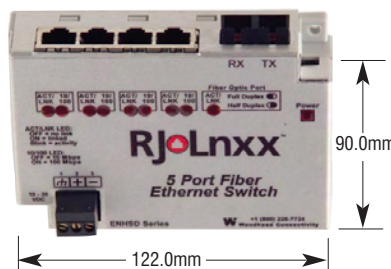

**Part Number Description**  
**ENHSDURS5** Ethernet Switch,  
4 x RJ-45 Ports  
1 x Duplex SC Port

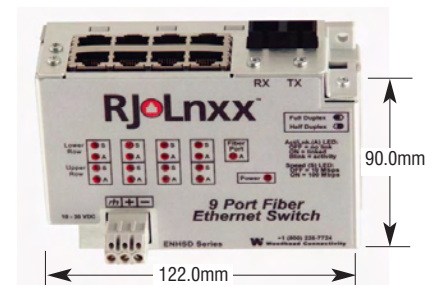

**Part Number Description**  
**ENHSDURS9** Ethernet Switch,  
8 x RJ-45 Ports  
1 x Duplex SC Port



# A full range of solutions for Industrial Automation and Controls

Active I/O Modules

Connection Systems

Active Switches

PC Interface Cards

PLC Interface Cards

Fibre Optic Connectors

Gateways

Software

**RJOLnxx**

**BRADHARRISON**

**mPm**

**applicom**  
Woodhead Connectivity

**SST**

## United Kingdom

Woodhead Connectivity Ltd.  
Factory No. 9  
Rassau Industrial Estate  
Ebbw Vale, Gwent  
Wales, NP23 5SD  
Tel. 01495-356300  
Fax. 01495-356301  
Email: contact@wdhd.co.uk

## France

Woodhead Connectivity S.A.  
57, Rue Jacquard BP523  
77465 Lagny Cedex  
Tel. 01 64 30 91 36  
Fax. 01 64 30 91 05  
Email: elithec@woodheadfr.com

Woodhead Software &  
Electronics S.A.  
43 rue Mazagran  
76320 Caudebec-lès-Elbeuf  
Tel: 02 32 96 04 20  
Fax: 02 32 96 04 21  
Email: info@applicom-int.com

## Germany

Woodhead Connectivity GmbH  
Gewerbestraße 60  
75015 Bretten-Gölschhausen  
Tel. 07252-9496-0  
Fax. 07252-9496-99  
Email: info@woodhead.de

Woodhead Software &  
Electronics GmbH.  
Im Gässle 9  
70771 Leinfelden-Echterdingen  
Tel: 07117-82374-0  
Fax: 07117-82374-11  
Email: infode@applicom-int.com

## Italy

mPm S.r.l.  
Via Zucchi  
39 int. G  
20095 Cusano Milanino (MI)  
Tel. 02-66400321  
Fax. 02-66400334  
Email: info@mpm.woodhead.it

I.M.A. S.r.l.  
Piazza della Vittoria,  
10 int.6  
16121 Genova  
Tel: 010-593077  
Fax: 010-5956925  
E-mail: infoit@applicom-int.com

## USA

Woodhead L.P.  
3411 Woodhead Drive  
Northbrook  
IL 60062  
Tel. 847-272-7990  
Fax. 847-272-8133

Woodhead L.P.  
11501 James Watt Drive  
El Paso  
TX 79936  
Tel. 915-591-5600  
Fax. 915-598-1718

## Canada

Woodhead Software &  
Electronics  
50 Northland Road  
Waterloo,  
Ontario  
N2V 1N3  
Tel. 519-725-5136  
Fax. 519-725-1515

Woodhead Canada Limited  
1090 Brevik Place  
Mississauga  
Ontario L4W 3Y5  
Tel. 905-624-6518  
Fax. 905-624-9151

## Mexico

Daniel Woodhead Company,  
Av. Presidente Masarik 61,  
Piso 2,  
Col. Chapultepec Morales,  
11570 Mexico, D.F.  
Tel. 52-1624-2504  
Fax. 52-1624-4029

## Singapore

Woodhead Asia Pte. Ltd.  
No. 4 Toh Tuck Link  
Level 3, Mezzanine  
Markono Logistics Building  
Singapore 596 226  
Tel. 261-6533  
Fax. 265-6605

## Japan

Woodhead Japan Corporation  
3G Kawashima No. 5 Bldg.  
29-16 Imaike-Minami  
Chikusa-ku  
Nagoya 464-0851 Japan  
Tel. 81-52-745-7621  
Fax. 81-52-745-7622



www.woodhead.com

Nano-Change® Micro-Change®, Mini-Change®, MPIS®, Brad®, Brad Harrison® and mPm® are all registered trademarks of Woodhead Industries, Inc.

Every effort has been made to ensure that the information contained within the catalogue is correct and as accurate as possible, no warranty as to this accuracy of this information is implied in any way. With our policy of continuous development, we reserve the right to change any detail within the catalogue without further notice.

All details contained within the catalogue are the sole copyright of Woodhead Connectivity Ltd, a Woodhead Industries, Inc. subsidiary and may not be copied or reproduced in any way without prior written consent. All other trade names and designs acknowledged.