

Airpax Series 5003 Thermostat

These thin, lightweight, wafer-type thermal switches are ideal for applications when space is at a premium. Overall depth without projecting terminals is only .250 inches.

The basic switch assembly is operated by a bimetal disc with positive, reinforced snap-action, which is known for its repeat reliability. The construction of the switch assembly offers excellent shock and vibration resistance. Thermal response is fast due to low mass.

For high humidity and contaminating atmosphere applications, the device is sealed with a non-volatile resin.

Narrow differential devices are ideal for control, while standard differentials can be used for high or low temperature limit switches. The Series 5003 Thermostat is UL recognized and CSA certified.

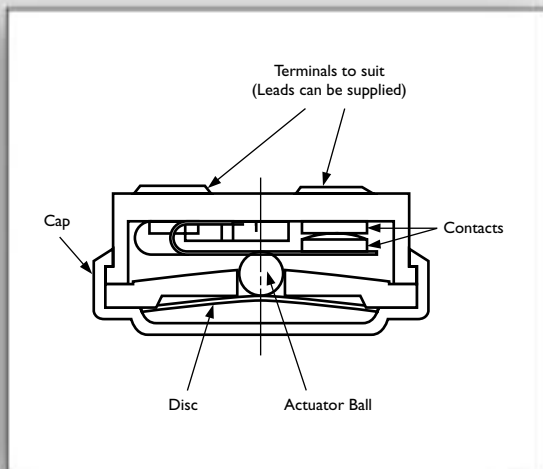
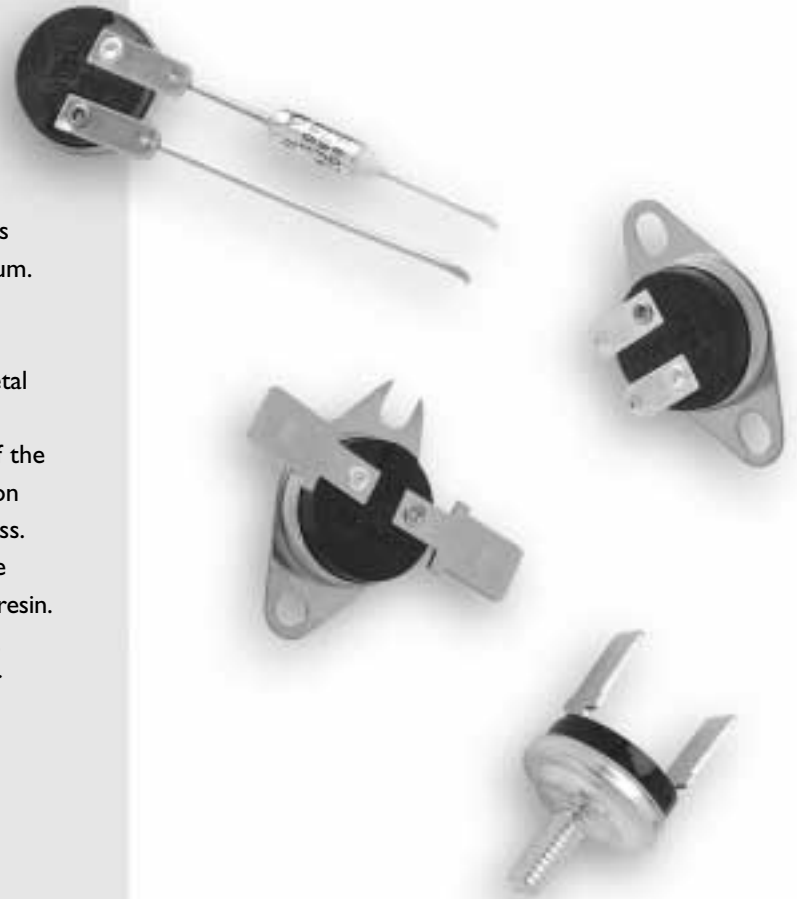

SPECIFICATIONS

- ***Contact Rating for 100,000 Life Cycles:**
5 amp resistive, 120 Vac
3 amp resistive, 240 Vac
- **Contacts:** SPST
- **Temperature Settings:** +35°F to +325°F
- **Dielectric:**
1500 VRMS 60Hz 1 min.
Terminals to case
- **Weight:** 2.3 grams (.08 oz.)
- **Exposure Limit:** -40°F to +350°F

** UL recognized to 130°C operating temperature.
CSA certified to 168°C operating temperature.
Loads under 100mA, 5Vdc, will require gold-plated contacts, with recommended minimum load of 10mA, 5Vdc.*

AIRPAX®

© Copyright 2000 Airpax · All Rights Reserved · 00094 2/00

SELECTION CODE CHART

A Contact Operation

Choose from codes across for specific contact operation (see chart).

CONTACT OPERATION

Code O = Open on Rise; **Code C** = Close on Rise

B Basic Series Number

Code 53 for all variations of this thermostat.

To establish your Airpax Thermostat Part Number precisely, choose the proper code letter from the following tables for terminal selection, terminal orientation and mounting selection. Then complete your selection code chart by using temperature specification tables 1 and 2.

HOW TO USE THIS CHART

Each thermostat P/N (Part Number) consists of functional “building blocks” to enable the user to specify clearly and precisely the desired characteristics in each selection category. Select the proper Code in each category, then transfer it to “Your PN” boxes to the right. Unless a special requirement (Code Z) is indicated, the entries in “Your PN” boxes will accurately specify a standard catalog item.

When Code Z is used, special features (not specified herein) or a unique part number is required, the last four digits from the part number (bottom temperature and tolerance) will be eliminated and a unique four digit number assigned by Airpax will be inserted. The example shown, records a selection of a standard item with a typical code specified in each “building block” category.

Note: See tables 1 and 2 for Operating Temperature Settings and Temperature Tolerances.

EXAMPLE PN:

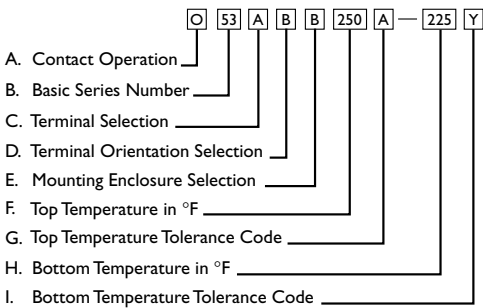

YOUR PN:

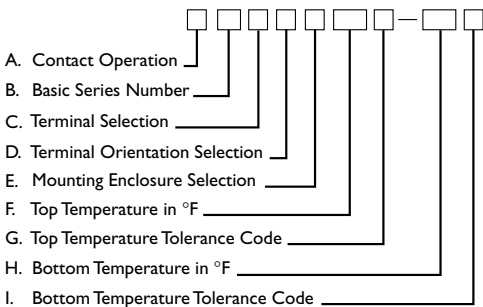

C Terminal Selection

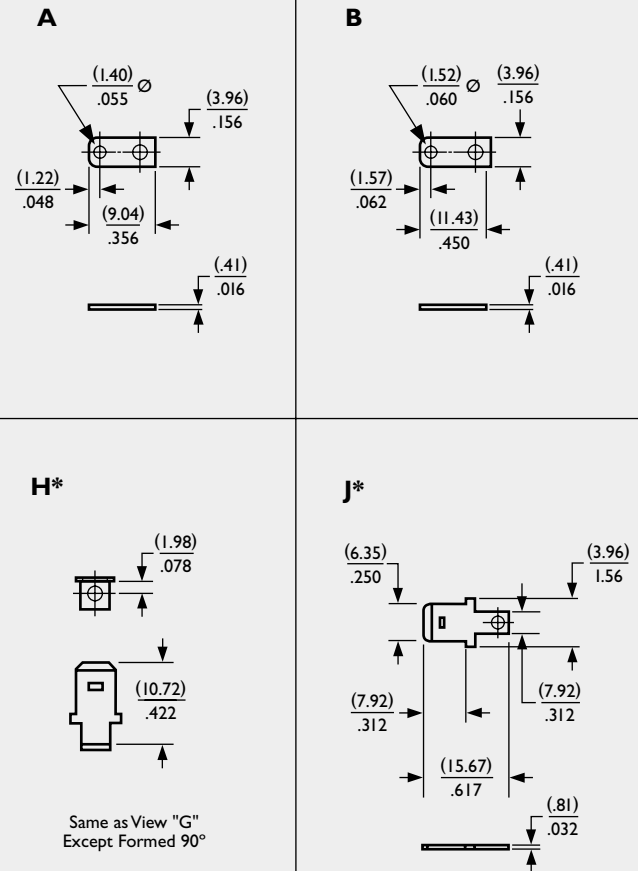

D Terminal Orientation Selection

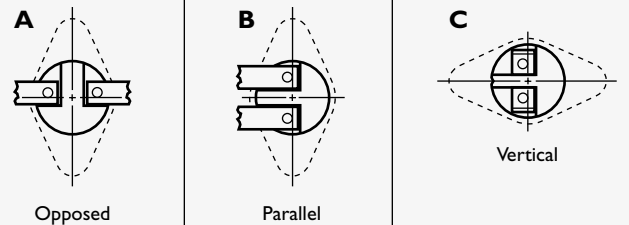

Z Special Requirements; Customer to Specify

NOTES: The standard lead wire (materials) for different temperature ranges are as follows:

A. Up to 220°F (104.4°C) #18 stranded UL 1015 AWN and CSA TEW approved (PVC insulation, color black).

B. 221°F to 350°F (105°C to 176.6°C) #18 stranded Type I TFE (Teflon® insulation per MIL-W-22759, color black).

*Not available with Code “B” terminal orientation

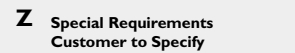
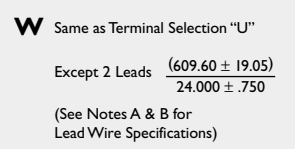
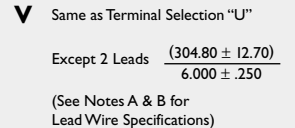
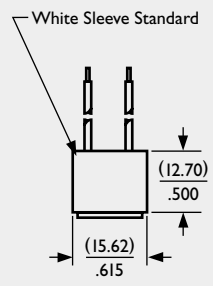
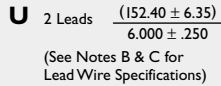
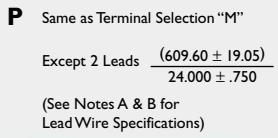
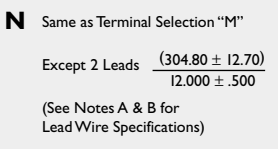
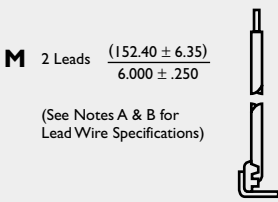
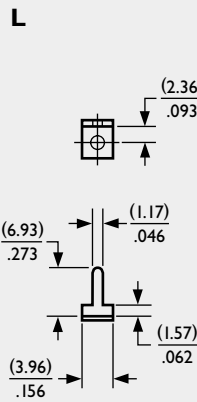
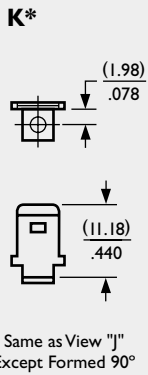
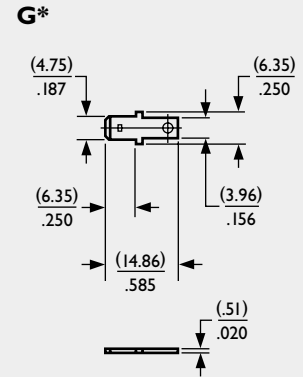
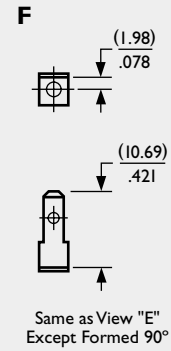
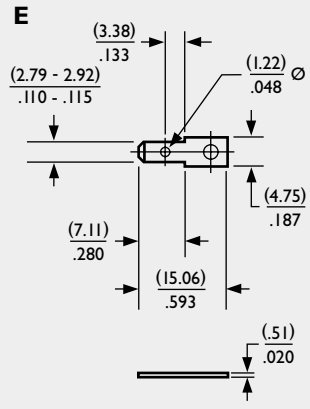
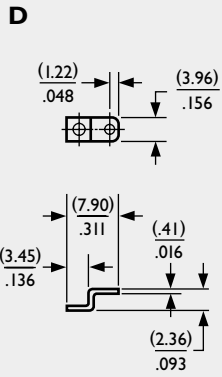
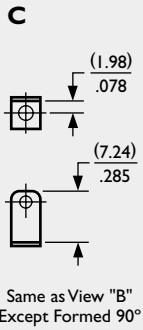

E Mounting and Enclosure Selection

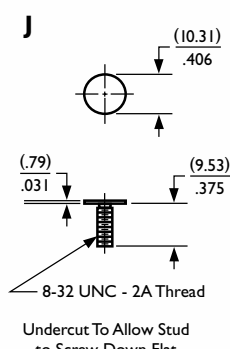
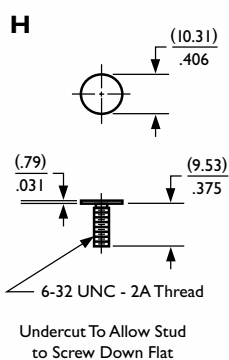
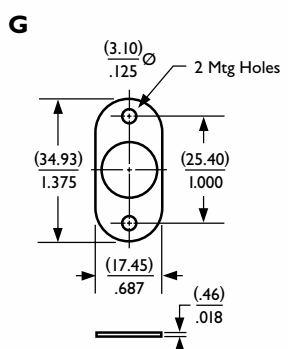
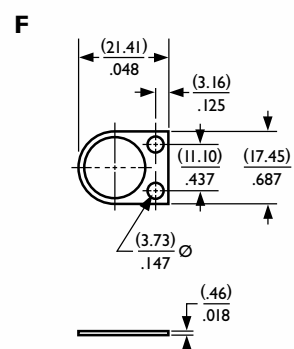
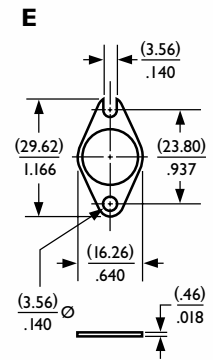
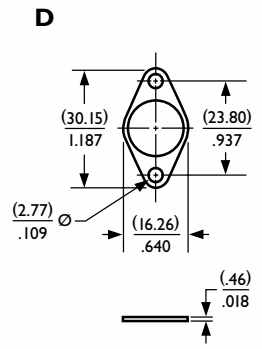
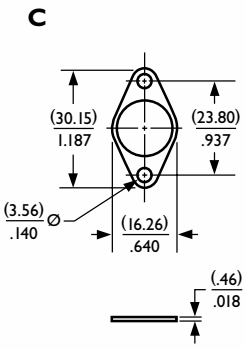
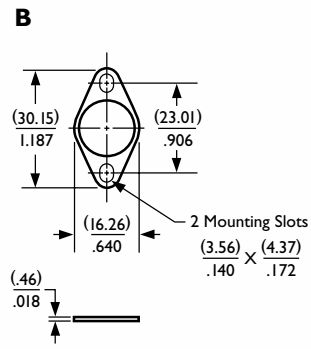
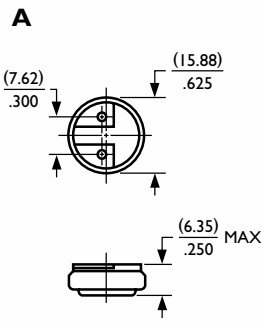

Z Special Requirements
Customer to Specify

TEMPERATURE SPECIFICATIONS

To complete your part number on Airpax Series 5003 Thermostats, the following information and charts will allow completion of “building blocks” F, G, H and I.

Table 1

OPERATING TEMPERATURE SETTINGS

	°F	°C	°F	°C	°F	°C
Temperature Setting	+35° to +200°	+1.6° to +93.3°	+201° to +300°	+93.8° to +148.8°	+301° to +325°	+149.4° to +162.8°
Standard Tolerance	±5°	±2.8°	±8°	±4.4°	±10°	±5.6°
Standard Nominal Differential	15	8.3	25	13.8	30	16.7

Table 2

TEMPERATURE TOLERANCE CODE FOR PART NUMBER SELECTION

CODE	A	B	C	X	Y
±°F	5	8	10	Maximum	Minimum
±°C	2.8	4.4	5.6	Maximum	Minimum

F Top Temperature in °F

Select any temperature in the range of 35°F to 325°F. See Table 1.

G Top Temperature Tolerance Code

Choose from the codes in Table 2, but don't select a tolerance more restrictive than those specified in Table 1.

H Bottom Temperature in °F

The bottom or reset temperature is obtained by subtracting the Standard Nominal Differential of the applicable range (Table 1) from the Top Temperature selected in step F.

I Bottom Temperature Tolerance Code

Choose from the codes in Table 2, applying the same restrictions used in selecting the Top Temperature Tolerance in step G. A minimum temperature is standard (“Y” designation).

For tolerances and differentials other than the standards in the above tables, please consult Airpax.

Temperature set point calibration is checked at the factory with precision test equipment traceable to the U.S. National Institute of Standards and Technology and Proven Methods. Because customer checking methods may differ, a typical variance for correlation is ±2°F (±1.1°C).

It is the customer's responsibility to determine whether the product is proper for customer's use and application.

This information is subject to change without notice.



©Copyright 2000 Airpax · All Rights Reserved · 00094 2/00

Airpax Corporation · Thermal Sensing Products
 550 Highland Street · Frederick, MD 21701 · USA
 TEL: 301.663.5141 · FAX: 301.698.0624 · www.airpax.net