

Handheld Oscilloscopes

THS3000 Series Data Sheet



Features & Benefits

Key Performance Specifications

- 100 MHz or 200 MHz Bandwidth Models
- Maximum Sample Rates up to 5 GS/s and 200 ps Resolution
- 4 Fully Isolated and Floating Channels
- 600 V_{RMS} CAT III, 1000 V_{RMS} CAT II Rated Inputs (BNC to Earth Ground)

Measurement and Analysis

- 21 Automatic Measurements
- Waveform Math and FFT Spectral Analysis
- Volts, Time, Frequency, Watts Cursor Measurements

Application Functions

- Measurement Data Logging with TrendPlot™
- Waveform Pass/Fail Limit Testing
- Automatic 100 Display Screens Recorder

Ease of Use Features

- 6 in. (153 mm) Bright Color Display
- USB Device and Host Support
- 7 Hours of Continuous Battery Operation

Applications

- Embedded Analog and Digital Design
- Power Devices, Power Electronics, and Power Supply Design
- Automotive and Avionics Design and Maintenance
- Industrial Equipment Design and Installation
- Field Test and Service

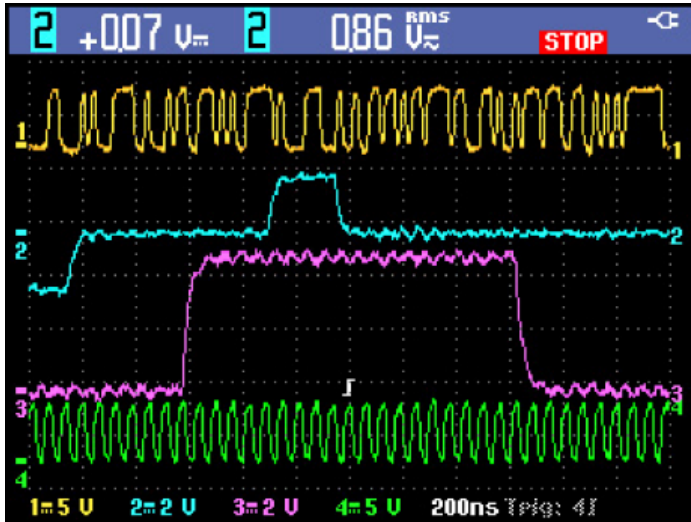

Four isolated input channels easily handle any type of mixed signal inputs.

Portable Performance for Challenging Environments

With 4 isolated channels and up to 7 hours of battery life, the lightweight THS3000 Handheld Oscilloscope Series enables you to safely make floating or differential measurements on your bench or in the field. Now you can tackle tough environments with the performance you expect from Tektronix – safely and affordably.

Accurately Measure Your Signals

With up to 200 MHz bandwidth, 4 channels, and 5 GS/s maximum sample rate, no other oscilloscope offers as much bandwidth and sample rate in a portable handheld form factor. The THS3000 Handheld Oscilloscope Series has 10,000 points record length per channel, enabling you to capture more signal information at higher sample rates to clearly see signal details. For applications where it is important to measure slow-changing signals over long time periods, the THS3000 Series offers Roll mode that extends the record length to 30,000 points of signal information.

Safely Make Floating and Differential Measurements

Making accurate and safe measurements on power electronics, power semiconductors, and other electronics applications can be challenging when the signal reference is floating and not referenced to earth ground. When your signal ranges from low voltage to high voltage (kV) or you must use probing techniques that can potentially create ground loops, the problem is compounded.

To enable floating measurements, the THS3000 Series is architecturally different than most other oscilloscopes. All input channels are fully isolated

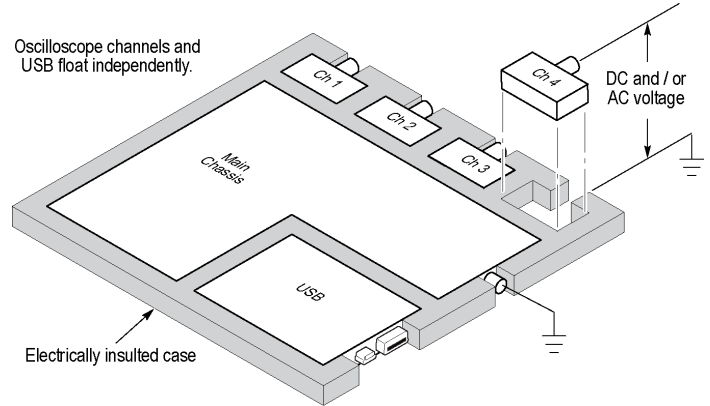

Isolated-channel technology is specified to 1000 V_{RMS} maximum float voltage.

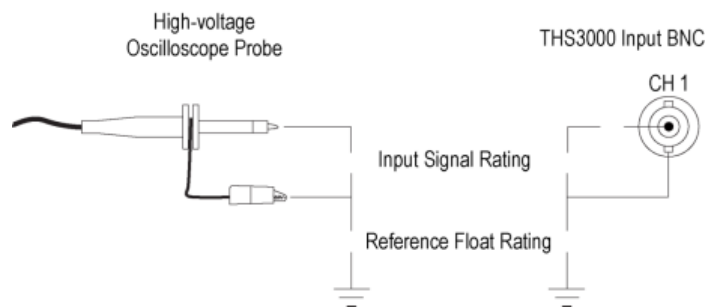

Input signal and float voltage maximum safety ratings.

from the main chassis and from each other. Additionally the power adapter and USB interface are fully isolated to ensure safe measurements and eliminate the risk of unintentional grounding or accidental short circuits. When configured with the proper probes you can be assured you'll be able to make quick, safe, and accurate measurements.

Selecting the Right Probe

Scope/Probe (Attenuation)	Maximum Safety Rating		THS3000 Viewable Signal	
	Reference Float Safety Rating*1	Input Signal Safety Rating	On-screen P-P Voltage	On-screen RMS Voltage
THS3000 (1X input)	600 V _{RMS} CAT III 1000 V _{RMS} CAT II	300 V _{RMS} CAT III	800 V _{P-P}	282 V _{RMS}
THP0301 (10X)	300 V _{RMS} CAT III	300 V _{RMS} CAT III	849 V _{P-P}	300 V _{RMS}
P5150 (50X)	600 V _{RMS} CAT II	1000 V _{RMS} CAT II	2828 V _{P-P}	1000 V _{RMS}
P5122 (100X)	600 V _{RMS} CAT II	1000 V _{RMS} CAT II	2828 V _{P-P}	1000 V _{RMS}

*1 Passive probe reference leads have no attenuation so any working voltage or overvoltage transients pass straight through to the scope reference. Thus, a passive probe reference float rating can never exceed the scope reference float rating.

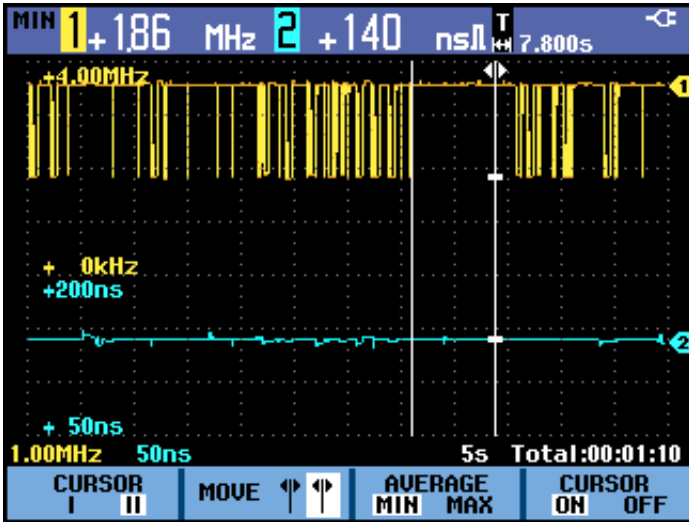

Analyze measurements and recordings visually or using measurement cursors.

Fast Analysis of Your Device

The THS3000 Handheld Oscilloscope Series is packed with analysis tools to help you validate your device's operation and identify issues quickly. With waveform math, you can add, subtract, or multiply any of your signals to investigate instantaneous power or look at gain. Vertical and horizontal cursors allow you to look at a specific point on your waveform for accurate measurements of voltage, current, time, or frequency. With 21 automated measurements, you can make common measurements quickly and accurately. The built-in Fast Fourier Transform (FFT) function allows you to see the frequency spectrum of your signal, revealing signal interference, crosstalk, or switching noise.

Find Intermittent Faults with TrendPlot™

Intermittent faults can be caused by timing errors, temperature changes, environmental influences, or simply broken wiring or connectors. The TrendPlot™ function helps you find those faults by plotting minimum and maximum measurement values over time. You can select up to 4 measurements and plot any combination of voltages, amps, frequency, time, and phase for any or all four inputs, all with time capture information.

Automatic Capture and Data Logging of 100 Display Screens

Capturing random or changing signals can often be difficult. The THS3000 Series greatly simplifies any type of waveform data logging by continuously capturing 100 display screens. Each screen capture can include multiple channels and math waveforms, each with its own time stamp. Data capture can also be tailored to specific events by selection of

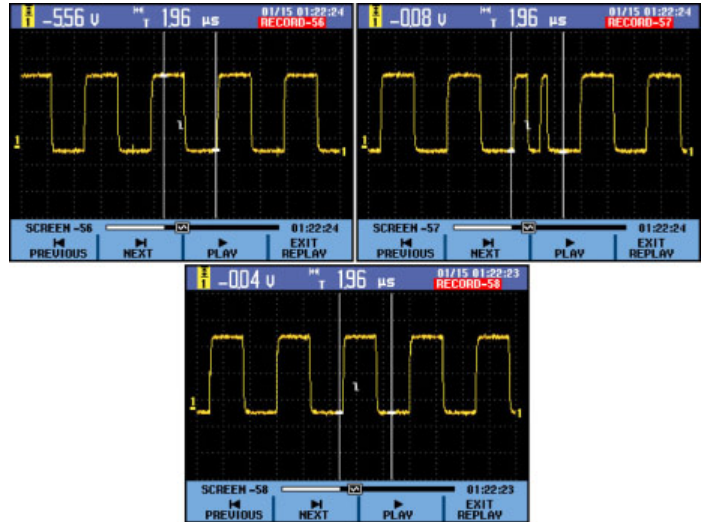

Playback of captured data is quick and easy with the THS3000 Series oscilloscopes.

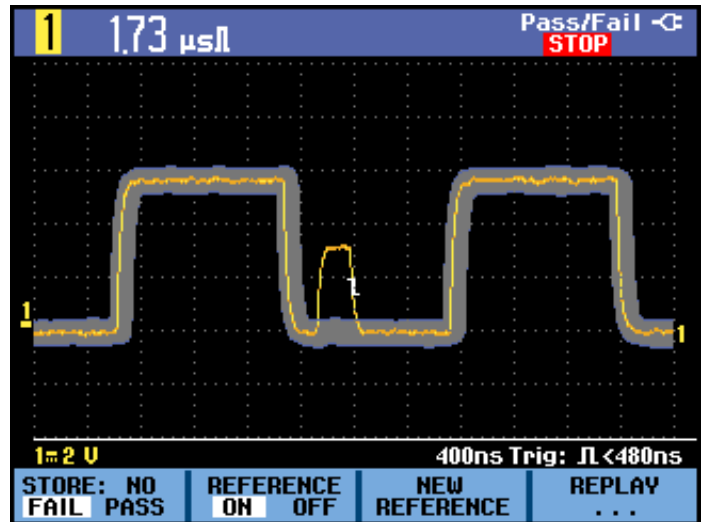

User-defined limit testing can easily identify random waveform anomalies.

qualified trigger conditions. Playback is quick and easy with the automatic replay of all captured screens or only the screens you select.

Waveform Limit Testing

The THS3000 Series can automatically monitor your signals and output Pass or Fail results by judging whether the input waveform is within predefined boundaries. User selections can include testing one or all input channels and automatic recording of Pass or Fail data. Data can easily be reviewed using the Replay mode or stored externally to a USB memory device.

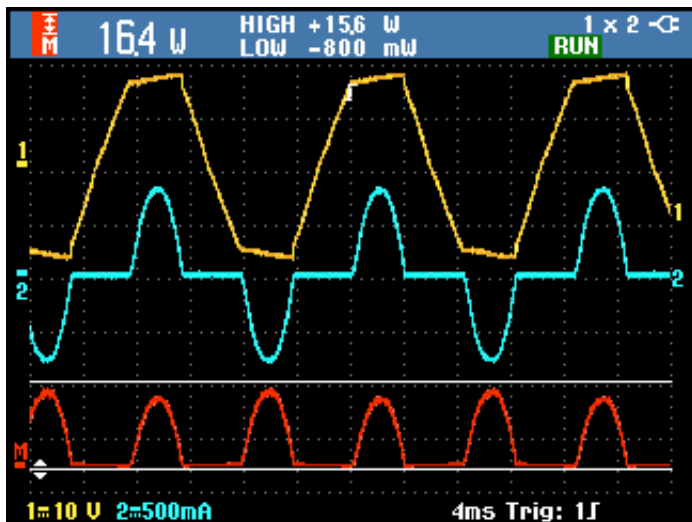

Easily calculate the instantaneous power by multiplying voltage and current waveforms.

Complete Solution for Power Measurements

For performing power measurement on motor drives, power converters/inverters, and power semiconductor devices the THS3000 Series is equipped to handle most common measurements. For basic debugging, the isolated input channels can be used with a variety of voltage and current probes. Each input channel can be configured to match the probe type and attenuation ensuring correct measurements and cursor readings. Four channels allow for easy measurements of three-phase power or simultaneous capture of digital control and power signals.

Measurements on power conversion electronics usually require probes with higher voltage ratings. Tektronix offers a passive probe with insulation systems specifically designed for making floating measurements. The standard THP0301-X can measure up to 849 V_{p-p} (300 V_{RMS}). Optional P5122 probes, when coupled with the THS3000 Series, are suitable for making measurements on 1000 V_{RMS} devices in Category II environments, with a maximum float voltage of up to 600 V_{RMS} relative to earth ground.

Designed to Make Your Work Easier

Intuitive Operation

The THS3000 Handheld Oscilloscope Series has a front-panel layout and an intuitive user interface which makes the instrument easy to use, reducing learning time and increasing efficiency. For initial setup or for situations where you're constantly changing connection points, the THS3000 Series has a single-button Autoset and Autorange feature which can automatically set up the trigger system and adjust vertical and/or horizontal oscilloscope settings.

Easy to Use

The bright color display makes it easy for you to see the signals you're measuring. Each waveform is color coded and designed to correspond to the colors on the input probe connectors, the front-panel channel selector

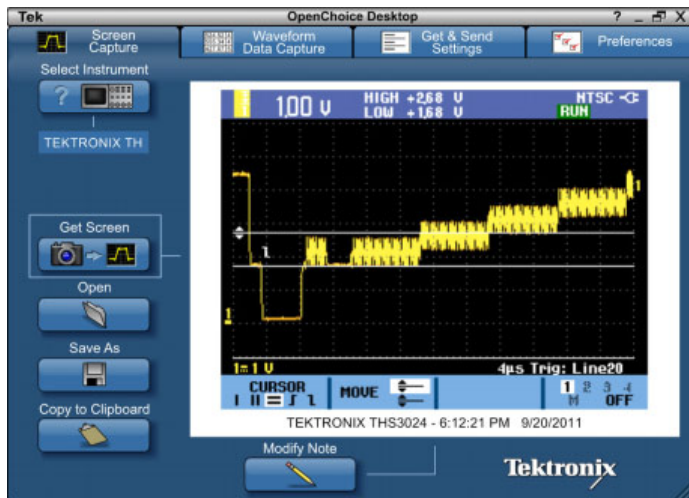

Tektronix OpenChoice® desktop software extends the capabilities of your instrument.



The standard USB ports facilitate data storage, data transfer, and instrument control.

buttons, and the individual probes which are colored at both ends. By matching the colors during setup you'll be assured you can easily identify your waveforms.

For setup assistance user messages are available in 11 user-selectable languages including English, French, German, Spanish, Portuguese, Italian, Japanese, Simplified and Traditional Chinese, Korean, and Russian.

Flexible Data Transfer

The THS3000 Series oscilloscopes come with both a USB host and USB mini port located on the side panel enabling you to quickly and easily save instrument settings, screenshots, and waveform data onto a flash device or transfer the data directly to a PC. The THS3000 Series is shipped with the Tektronix OpenChoice® desktop software, allowing you to integrate your new THS3000 Series oscilloscope into existing measurement systems and take advantage of extended functionalities in data acquisition, measurement analysis, and documentation.

Versatility and Portability for Wherever Your Job Takes You

With a battery life of 7 hours and a weight of only 4.8 lb. (2.2 kg) the THS3000 Handheld Oscilloscope Series offers ultimate portability. Measurements taken in the lab can now be conveniently correlated with those taken in the field – all on the same instrument. Rated IP41, the THS3000 Series features the ruggedness needed to go beyond the lab and into industrial and field environments. The optional travel kit comes with a hard-sided carrying case and useful accessories allowing you to take the THS3000 Series on the road securely and conveniently. From the lab to the field, the THS3000 Handheld Oscilloscope Series offers you the versatility of using a single, high-performance instrument suitable for a wide range of working environments.

Performance You Can Count On

In addition to industry-leading service and support, every THS3000 Series oscilloscope comes backed with a three-year standard warranty, and ships with a Certificate of Traceable Calibration Standard.

Characteristics

Vertical System Analog Channels

Characteristic	THS3014	THS3024
Isolated Input Channels	4	4
Analog Bandwidth (–3 dB)	100 MHz	200 MHz
Rise Time	3.5 ns	1.7 ns
Hardware Bandwidth Limits	20 kHz, 20 MHz, or full	
Input Coupling	AC, DC	
Input Impedance	1 M Ω \pm 1%, 14 pF \pm 2 pF	
Input Sensitivity Range	2 mV/div to 100 V/div	
Vertical Resolution	8 bits	
DC Gain Accuracy	\pm 2.1% of reading +0.04 \times range/div for 5 mV/div to 100 V/div	
Max BNC Input Voltage	(1 M Ω) 300 V _{RMS} CAT III from BNC signal to BNC shell	
Max Probe Voltage (with standard THP0301-X probe)	300 V _{RMS} CAT III from 10:1 probe tip signal to BNC and reference lead	
Float Voltage	1000 V _{RMS} CAT II / 600 V _{RMS} CAT III from BNC shell to earth ground	
Trace Positioning	\pm 4 divisions	

Horizontal System

Characteristic	THS3014	THS3024
Maximum Sample Rate	2.5 GS/s (1.25 GS/s 4-ch)	5 GS/s (1.25 GS/s 4-ch)
Maximum Record Length (All channels)	10,000 points (30,000 points in Roll mode (4 ms to 2 min / div))	
Time-base Range (s/div)	5 ns to 4 s	2 ns to 4 s
Delay Time Range	1 full screen (12 divisions) of pre-trigger or up to 100 screens (1,200 divisions) of post-trigger	
Timing Accuracy	\pm 100 ppm + 0.04 div	
Zoom	Horizontally expand or compress a live or stopped waveform	



The optional travel kit (TK) version includes a hard-sided carry case for your instrument, accessories, and storage space for a laptop PC.

Trigger System

Characteristic	Description
Input Source	Channel 1, 2, 3, or 4. All input references isolated from each other and earth ground
Main Trigger Modes	Auto-level, Auto, Normal, and Single
Trigger Coupling	DC, HF Reject, Noise Reject (reduces sensitivity)

Trigger Sensitivity

Characteristic	Description
Internal DC Coupled	0.5 divisions from DC to 5 MHz at >5 mV/div 1 divisions >5 MHz to 200 MHz (THS3024) 1 divisions >5 MHz to 100 MHz (THS3014)

Trigger Level Range

Characteristic	Description
Any Channel	\pm 4.0 divisions

Trigger Modes

Mode	Description
Edge	Positive, negative, or dual slope on any input channel. Coupling includes DC, HF Reject, and Noise Reject
Pulse Width	Trigger on Channel 1, width of positive or negative pulses (glitches) that are >, <, =, or \neq a specified period of time (resolution of 0.01 div with minimum time of 50 ns)
Event	Trigger on N-th occurrence of trigger (N selectable from 2 to 99)
Video	Trigger on Channel 1, line number, all lines, odd, even, or all fields on NTSC, PAL, PAL Plus, and SECAM signals
Non-interlaced	Trigger on Channel 1, high-res non-interlaced video with line frequencies from 14 kHz to 65 kHz

Acquisition Modes

Mode	Description
Sample (Default)	Acquire sampled values
Glitch Detect	Captures high frequency or glitches as narrow as 8 ns from 5 μ s to 120 s / div
Averaging	Selectable from 2, 4, 8, or 64 waveforms
Roll	Scrolls waveforms right to left across the screen at sweep speeds slower than or equal to 4 ms/div
Data Recorder	Automatic data logging of 100 triggered records (screens) with date and time stamp. Store internally or to a USB device
Waveform Compare	Visually compare against user-definable reference waveforms or perform automatic Pass or Fail testing of 1 to 4 channels with data logging of test results

Automatic Setup

Mode	Description
Autoset	Single-button, automatic setup of all channels for vertical, horizontal, and trigger systems
Autorange	Continuous auto-setup of vertical, horizontal, and trigger systems that track signal changes

Waveform Measurements

Characteristic	Description
Cursors	Time, Freq (1/T), Volts, Watts, Rise/Fall Time from any input channel or math waveform
Automatic Measurements	21. Up to 4 can be displayed on-screen at any one time. Measurements include: V DC, V AC _{RMS} , V AC+DC, V _{Peak} Max, V _{Peak} Min, Peak to Peak, A DC, A AC, A AC+DC, Frequency, Rise Time (using cursors), Fall Time (using cursors), Phase (between any 2 inputs), Positive Pulse Width, Negative Pulse Width, Positive Duty Cycle, Negative Duty Cycle, dBV, dBm into 50 Ω and 600 Ω
TrendPlot™	Records and graphically displays any 4 automatic scope measurements. Store internally or to USB flash drive for recall and analysis

Waveform Math

Characteristic	Description
Arithmetic	Add, subtract, and multiply waveforms
FFT	Spectral magnitude. Set FFT Vertical Scale to Linear or Logarithmic, and FFT Window to Automatic, Hamming, Hanning, or None

Display Characteristics

Characteristic	Description
Display Type	6 in. (153 mm) Liquid-crystal Color Display
Display Resolution	320 horizontal \times 240 vertical pixels
Waveform Style	Vectors (dot-join), Dots, Envelope, Variable Persistence, Infinite Persistence
Display Format	YT and XY

Storage Memory

Characteristic	Description
Reference	4 user-definable reference traces
Waveform	Stores 30 internal scope records (4 traces each) with screen image and corresponding setup
Recording	Store 10 internal recordings that can be a 100-screen replay sequence, a Roll-mode recording, or a TrendPlot™ measurement recording
Screen Image	Store up to 9 internally or 256 BMP images to an external USB storage drive
Real-time Clock	Time and date stamp of all stored data

Input/Output Ports

Port	Description
USB Host Port	Supports USB mass storage devices
USB Device Port	Mini-USB-B connector allows for communication/control of oscilloscope
Probe Compensator Output	Side-panel Output – Amplitude: 1.225 V _{p-p} Frequency: 500 Hz
Kensington-style Lock	Side-panel security slot connects to standard Kensington-style lock

Software

Product	Description
OpenChoice® Desktop	Enables fast and easy communication between a Windows PC and the THS3000 Series. Transfer and save settings, waveforms, and screen images

Power Source

Characteristic	Description
Battery	7 hour, 10.8 V rechargeable Li-Ion battery
Battery Charging Time	5 hours
Line Power	AC power adapter/charger
Power Source Voltage	100 V to 240 V AC \pm 10%
Power Source Frequency	50 Hz to 60 Hz

Physical Characteristics

Dimension	mm	in.
Height	265	10.5
Width	190	7.5
Depth	70	2.8
Weight	kg	lb.
Net (with battery)	2.2	4.8
Shipping (Base model)	4.7	10.4
Shipping (TK model)	7.8	17.1

Environmental

Characteristic	Description
Enclosure	IP 41 according to IEC60529
Temperature	
Operating	0 °C to +40 °C (with battery) 0 °C to +50 °C (without battery)
Nonoperating	-20 °C to +60 °C
Humidity	
Operating	10 °C to 30 °C, up to 95% relative humidity, noncondensing 30 °C to 40 °C, up to 75% relative humidity, noncondensing 40 °C to 50 °C, up to 45% relative humidity, noncondensing
Nonoperating	-20 °C to 60 °C, relative humidity, noncondensing
Altitude	
Operating	Up to 3,000 m (9,843 ft.)
Nonoperating	Up to 12,000 m (39,370 ft.)
Vibration/Shock	
Operating	Vibration (Sinusoidal): 3 g max, according to MIL-PRF-28800F, Class 2 Shock: 30 g max, according to MIL-PRF-28800F, Class 2
Nonoperating	Vibration (Random): 0.03 g ² /Hz, according to MIL-PRF-2800F, Class 2
Regulatory	
Electromagnetic Compatibility	EN 61326-1:2006, EN 61326-2-1:2006 for emission and immunity
Safety	UL61010-1:2004; CAN/CSA C22.2 No. 61010.1-04; EN61010-1:2001, Pollution Degree 2; ANSI/ISA-82.02.01

Ordering Information**THS3000 Models**

Model	Description
THS3014	100 MHz, 2.5 GS/s, 4-channel handheld oscilloscope
THS3014-TK	100 MHz, 2.5 GS/s, 4-channel handheld oscilloscope with travel kit
THS3024	200 MHz, 5 GS/s, 4-channel handheld oscilloscope
THS3024-TK	200 MHz, 5 GS/s, 4-channel handheld oscilloscope with travel kit

All Models Include: THP0301-Y/B/M/G 300 MHz 10X Passive Probes, Lithium-ion Battery with 7-hour battery life, Carrying Handle, Hanging Strap, USB-A to Mini USB-B Cable for PC communication, Installation/Safety Manual, Documentation CD (available in English, French, German, Spanish, Italian, Portuguese, Korean, Japanese, Simplified Chinese, Traditional Chinese, and Russian) (063-4379-xx), AC Power Adapter with Power Cord, ACHHS Soft-sided Carry Case (standard with base model), OpenChoice® Desktop PC Communication Software, Calibration Certificate Documenting Traceability to National Metrology Institute(s) and ISO9001 Quality System Registration, Three-year Warranty.

TK Models Also Include: Hard-sided travel case, soft-sided probe case, 2 probe replacement accessory kits.

Please specify power plug when ordering.

Recommended Accessories

Accessory	Description
THSBAT	Additional spare battery
THSCHG	Battery charger (does not include AC power adapter)
ACHHS	Instrument soft case
HCHHS	Instrument hard case (standard with TK models)
376-0255-xx	Versatile hanging hook
020-3085-xx	Probe replacement accessory kit
119-7900-00	AC power adapter

Recommended Probes

Probe	Description
A621	2000 A, 5 kHz to 50 kHz AC current probe/BNC
A622	100 A, 100 kHz AC/DC current probe/BNC
P5122	200 MHz passive 100X high-voltage probe
P5150	500 MHz passive 50X high-voltage probe* ²
CT2	2.5 A, 200 MHz AC current probe
TCP303/TCPA300	150 A, 15 MHz AC/DC current probe/amplifier
TCP305/TCPA300	50 A, 50 MHz AC/DC current probe/amplifier
TCP312/TCPA300	30 A, 100 MHz, AC/DC current probe/amplifier
TCP404XL/TCPA400	500 A, 2 MHz AC/DC current probe/amplifier

*² The P5150 is fully compatible with THS oscilloscopes, but 50X vertical scaling is not offered.

International Power Plugs

Option	Description
Opt. A0	North America power
Opt. A1	Universal Euro power
Opt. A2	United Kingdom power
Opt. A3	Australia power
Opt. A5	Switzerland power
Opt. A6	Japan power
Opt. A10	China power
Opt. A11	India power

Warranty

Three-year warranty covering all parts and labor, excluding probes.

Contact Tektronix:

ASEAN / Australasia (65) 6356 3900
Austria 00800 2255 4835*
Balkans, Israel, South Africa and other ISE Countries +41 52 675 3777
Belgium 00800 2255 4835*
Brazil +55 (11) 3759 7627
Canada 1 800 833 9200
Central East Europe and the Baltics +41 52 675 3777
Central Europe & Greece +41 52 675 3777
Denmark +45 80 88 1401
Finland +41 52 675 3777
France 00800 2255 4835*
Germany 00800 2255 4835*
Hong Kong 400 820 5835
India 000 800 650 1835
Italy 00800 2255 4835*
Japan 81 (3) 6714 3010
Luxembourg +41 52 675 3777
Mexico, Central/South America & Caribbean 52 (55) 56 04 50 90
Middle East, Asia, and North Africa +41 52 675 3777
The Netherlands 00800 2255 4835*
Norway 800 16098
People's Republic of China 400 820 5835
Poland +41 52 675 3777
Portugal 80 08 12370
Republic of Korea 001 800 8255 2835
Russia & CIS +7 (495) 7484900
South Africa +41 52 675 3777
Spain 00800 2255 4835*
Sweden 00800 2255 4835*
Switzerland 00800 2255 4835*
Taiwan 886 (2) 2722 9622
United Kingdom & Ireland 00800 2255 4835*
USA 1 800 833 9200

* European toll-free number. If not accessible, call: +41 52 675 3777

Updated 10 February 2011

For Further Information. Tektronix maintains a comprehensive, constantly expanding collection of application notes, technical briefs and other resources to help engineers working on the cutting edge of technology. Please visit www.tektronix.com



Copyright © Tektronix, Inc. All rights reserved. Tektronix products are covered by U.S. and foreign patents, issued and pending. Information in this publication supersedes that in all previously published material. Specification and price change privileges reserved. TEKTRONIX and TEK are registered trademarks of Tektronix, Inc. All other trade names referenced are the service marks, trademarks, or registered trademarks of their respective companies.

10 Nov 2011

3GW-27121-0

