

0.56" Dual Digit Display

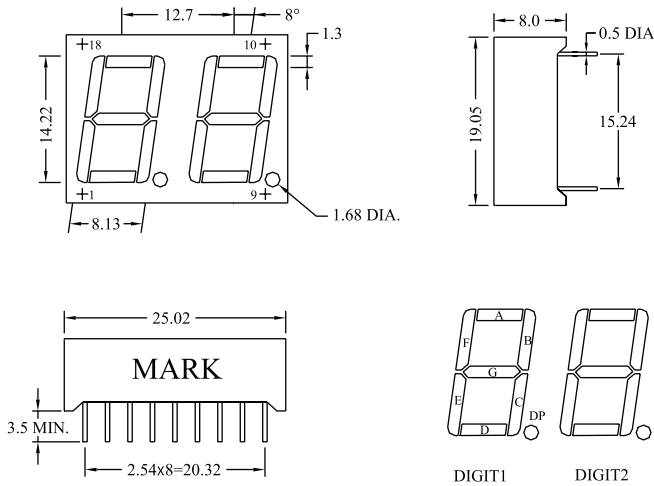

Package Dimensions:



Internal Circuit Diagram:

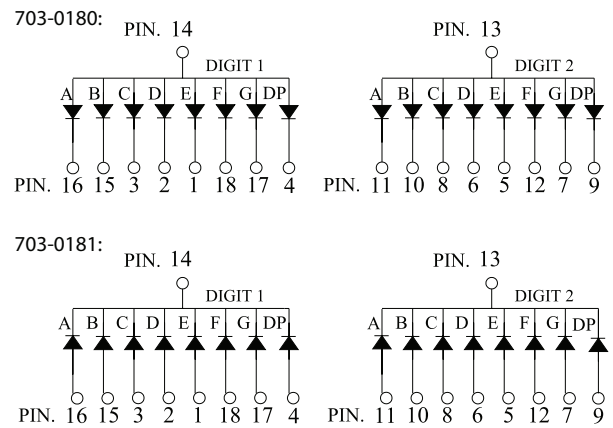

All dimensions are in mm
 Tolerance: $\pm 0.25\text{mm}$
 The slope angle of any PIN may be $\pm 5^\circ$ max

Absolute Maximum Ratings at $T_a=25^\circ\text{C}$

Parameter	Symbol	Rating	Unit
Power Dissipation - Pre Segment	P_D	78	mW
Pulse Current (1/10 Duty Cycle, 0.1ms Pulse Width) - Per Chip	I_{FP}	100	mA
Forward Current - Per Chip	I_F	30	mA
Reverse (Leakage) Current - Per Chip	I_r	100	μA
Reverse Voltage - Per Chip	V_R	5	V
Operating Temperature Range	Topr.	-25 to +85	$^\circ\text{C}$
Storage Temperature Range	Tstg.	-40 to +100	$^\circ\text{C}$
Soldering Temperature	Tsol.	Dip Soldering: 260°C for 5sec. Hand Soldering: 350°C for 3 sec.	



0.56" Dual Digit Display



Electrical & Optical Characteristics:

Parameter	Symbol	Condition	Min.	Typ.	Max.	Unit
Luminous Intensity - Per Segment	I_v	$I_f=10\text{mA} / \text{seg.}$	0.72	2.9		mcd
Forward Voltage	V_f	$I_f=20\text{mA} / \text{seg.}$		2.1	2.6	V
Peak Wavelength	λ_p	$I_f=20\text{mA} / \text{seg.}$		567		nm
Dominant Wavelength	λ_d	$I_f=20\text{mA} / \text{seg.}$		572		nm
Reverse Current - Per Chip (Leakage Current - Per Chip)	I_r	$V_r=5\text{V}$			100	μA
Spectrum Line Halfwidth	$\Delta\lambda$	$I_f=20\text{mA} / \text{seg.}$		30		deg
Response Time	T			250		nm

Note: Customer's special requirements are also welcome.

Typical Electrical & Optical Characteristics Curves:

(25°C Ambient temperature unless otherwise noted)

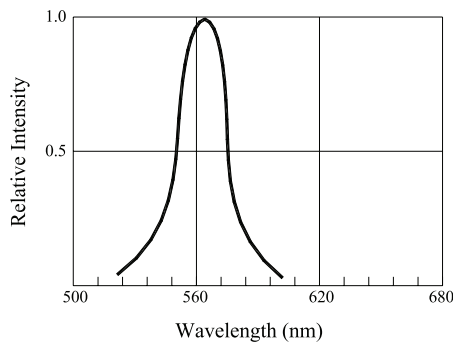

Fig.1 RELATIVE INTENSITY VS. WAVELENGTH

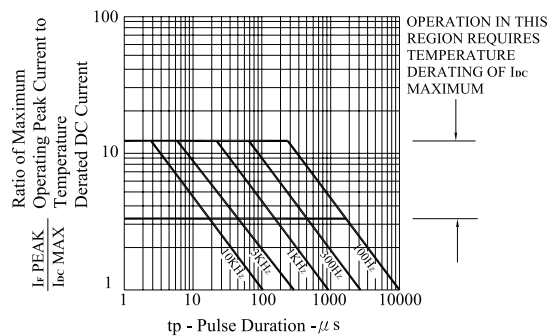

Fig.2 MAXIMUM TOLERABLE PEAK CURRENT VS. PULSE DURATION

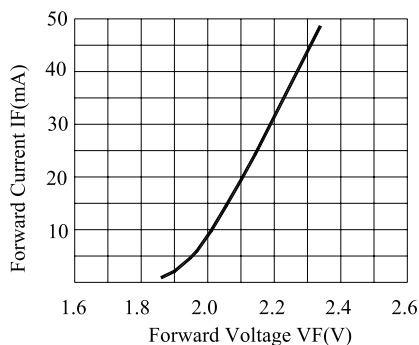

Fig.3 FORWARD CURRENT VS. FORWARD VOLTAGE PER CHIP

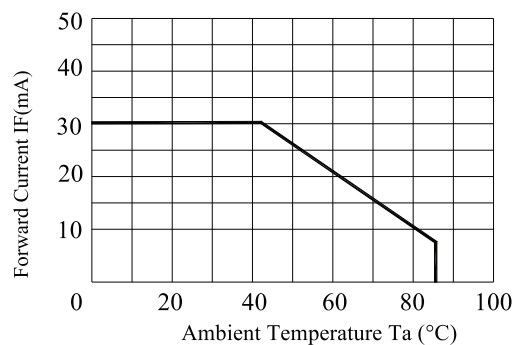

Fig.4 FORWARD CURRENT VS. DERATING CURVE

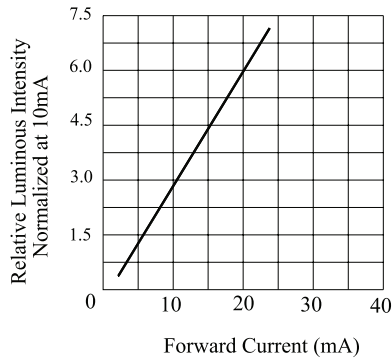

Fig.5 RELATIVE LUMINOUS INTENSITY VS. FORWARD CURRENT

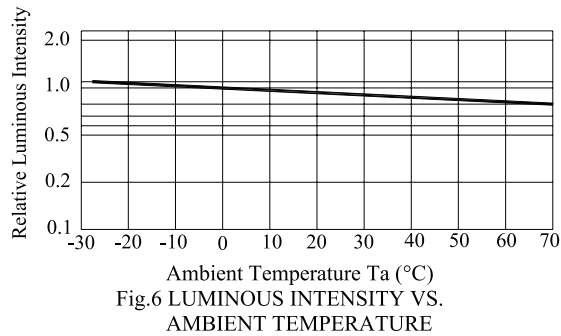

Fig.6 LUMINOUS INTENSITY VS. AMBIENT TEMPERATURE

Part Number Table

LED Chip		Face Colour		Part Number
Material	Emitting Colour	Surface	Segments	
GaP / GaP	Green	Grey	White	703-0180
GaP / GaP	Green	Grey	White	703-0181

Important Notice : This data sheet and its contents (the "Information") belong to the members of the Premier Farnell group of companies (the "Group") or are licensed to it. No licence is granted for the use of it other than for information purposes in connection with the products to which it relates. No licence of any intellectual property rights is granted. The Information is subject to change without notice and replaces all data sheets previously supplied. The Information supplied is believed to be accurate but the Group assumes no responsibility for its accuracy or completeness, any error in or omission from it or for any use made of it. Users of this data sheet should check for themselves the Information and the suitability of the products for their purpose and not make any assumptions based on information included or omitted. Liability for loss or damage resulting from any reliance on the Information or use of it (including liability resulting from negligence or where the Group was aware of the possibility of such loss or damage arising) is excluded. This will not operate to limit or restrict the Group's liability for death or personal injury resulting from its negligence. Multicomp is the registered trademark of the Group. © Premier Farnell plc 2012.