

1W High Power LED

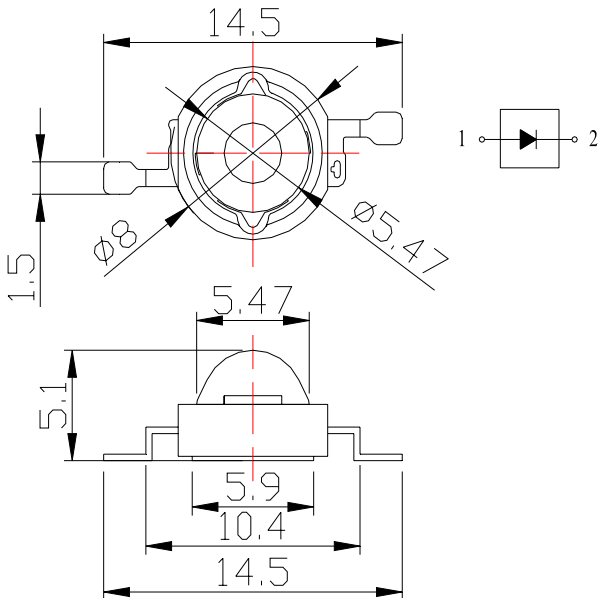

Package Dimensions:



* All dimensions are in mm
* Tolerance: $\pm 0.6\text{mm}$ unless otherwise noted.

Ant Part No.	LED Chip		Lens Colour
	Material	Colour Coordinates	
703-0147	InGaN/GaN	Blue	Water clear

Absolute Maximum Ratings at $T_a=25^\circ\text{C}$:

Parameter	Rating	Unit
Power Dissipation	1365	mW
LED Junction Temperature	120	$^\circ\text{C}$
Reverse Voltage	5	V
D.C. Forward Current	350	mA
Pulsed Forward Current; $t_p \leq 100\mu\text{s}$, Duty Cycle = 0.005)*1	700	mA
Operating Temperature Range	-40 to +75	$^\circ\text{C}$
Storage Temperature Range	-40 to +100	$^\circ\text{C}$
Soldering Temperature	Dip Soldering: 260°C for 10sec. Hand Soldering: 350°C for 3sec.	
Electric Static Discharge Threshold (HBM)	6000	V

Important Notice: This data sheet and its contents (the "Information") belong to the members of the Premier Farnell group of companies (the "Group") or are licensed to it. No licence is granted for the use of it other than for information purposes in connection with the products to which it relates. No licence of any intellectual property rights is granted. The Information is subject to change without notice and replaces all data sheets previously supplied. The Information supplied is believed to be accurate but the Group assumes no responsibility for its accuracy or completeness, any error in or omission from it or for any use made of it. Users of this data sheet should check for themselves the Information and the suitability of the products for their purpose and not make any assumptions based on information included or omitted. Liability for loss or damage resulting from any reliance on the Information or use of it (including liability resulting from negligence or where the Group was aware of the possibility of such loss or damage arising) is excluded. This will not operate to limit or restrict the Group's liability for death or personal injury resulting from its negligence. Multicomp is the registered trademark of the Group. © Premier Farnell plc 2011.

1W High Power LED



Duty Cycle:

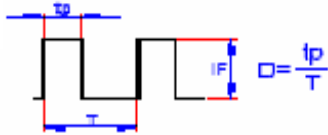

Notes:

1. Proper current derating must be observed to maintain junction temperature below the maximum.
2. All products not sensitive to ESD damage (6000 Volts by HBM condition).
3. Be careful with powered up current limited power supply, because of current spikes during power up and /or connection. Best practice is to connect the LED then turn up the voltage gradually. People building their own power supplies should design for minimum current spikes during power up and connection.
4. For best results the customer needs to provide proper control of the thermal path, protect against electrical overstress conditions and ensure the emitters are properly attached to the mcpcb/heat sink.
5. It is recommended that the temperature of lead does not exceed 55 °C.
6. It is recommended to apply an electrically isolated heat conductive film between slug and contact surfaces.

Electrical & Optical Characteristics:

Parameter	Symbol	Condition	Value			Unit
			Min.	Typ.	Max.	
Luminous Flux	FULL	IF = 350 mA	-	21	-	lm
	Rank L1		10	-	25	
	Rank L2		25	-	40	
Forward Voltage	Rank V1	IF = 350 mA	2.9	-	3.1	V
	Rank V2		3.1	-	3.3	
	Rank V3		3.3	-	3.5	
	Rank V4		3.5	-	3.7	
	Rank V5		3.7	-	3.9	
Dominant Wavelength	λ_d	IF = 350 mA	455	-	460	nm
			460	-	465	
			465	-	470	
			470	-	475	
			475	-	480	
Reverse Current	IR	Vr = 5V	-	-	50	μ A
View Angle at 50% IV	$2\theta_{1/2}$	IF = 350 mA	-	130	-	deg
Thermal resistance Junction to Case	R θ_{J-c}	IF = 350 mA	-	15	-	°C/W

- Notes:**
1. The data is tested by an IS tester.
 2. Customer's special requirements are also welcome.

Important Notice: This data sheet and its contents (the "Information") belong to the members of the Premier Farnell group of companies (the "Group") or are licensed to it. No licence is granted for the use of it other than for information purposes in connection with the products to which it relates. No licence of any intellectual property rights is granted. The Information is subject to change without notice and replaces all data sheets previously supplied. The Information supplied is believed to be accurate but the Group assumes no responsibility for its accuracy or completeness, any error in or omission from it or for any use made of it. Users of this data sheet should check for themselves the Information and the suitability of the products for their purpose and not make any assumptions based on information included or omitted. Liability for loss or damage resulting from any reliance on the Information or use of it (including liability resulting from negligence or where the Group was aware of the possibility of such loss or damage arising) is excluded. This will not operate to limit or restrict the Group's liability for death or personal injury resulting from its negligence. Multicomp is the registered trademark of the Group. © Premier Farnell plc 2011.





Typical Electrical / Optical Characteristic Curves:

(25°C Ambient Temperature unless otherwise noted)

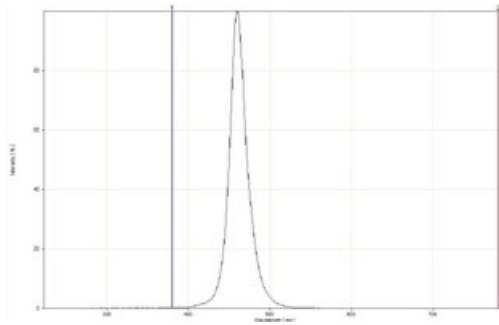
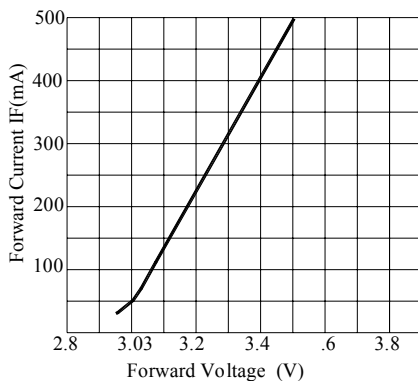
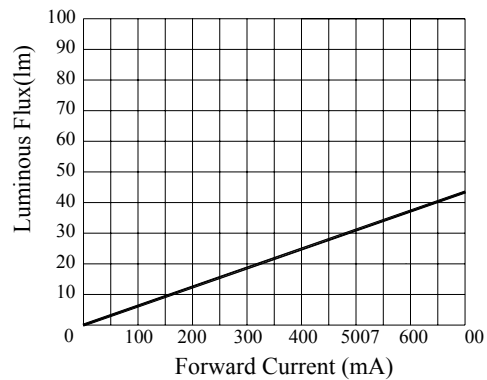

Fig.1 WHITE LED Spectrum VS. WAVELENGTH



Forward Current VS. Applied Voltage



Forward Current VS. Luminous Flux

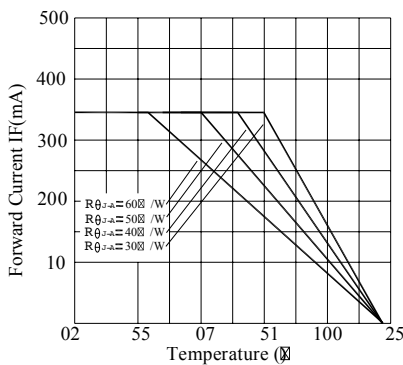

Ambient Temperature VS. Forward Current

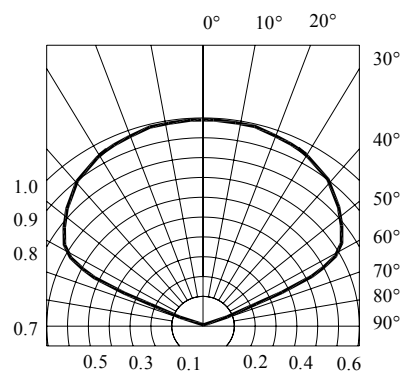

Radiation Diagram

Important Notice: This data sheet and its contents (the "Information") belong to the members of the Premier Farnell group of companies (the "Group") or are licensed to it. No licence is granted for the use of it other than for information purposes in connection with the products to which it relates. No licence of any intellectual property rights is granted. The Information is subject to change without notice and replaces all data sheets previously supplied. The Information supplied is believed to be accurate but the Group assumes no responsibility for its accuracy or completeness, any error in or omission from it or for any use made of it. Users of this data sheet should check for themselves the Information and the suitability of the products for their purpose and not make any assumptions based on information included or omitted. Liability for loss or damage resulting from any reliance on the Information or use of it (including liability resulting from negligence or where the Group was aware of the possibility of such loss or damage arising) is excluded. This will not operate to limit or restrict the Group's liability for death or personal injury resulting from its negligence. Multicomp is the registered trademark of the Group. © Premier Farnell plc 2011.

1W High Power LED



Storage:

Recommended storage environment:

- Temperature: 5°C ~ 30°C (41°F ~ 86°F)
- Humidity: 60% RH Max.
- Moisture measures: Please refer to Moisture-sensitive label on reels package bags. If unused LEDs remain, they should be stored in moisture proof packages, such as a sealed container with packages of moisture absorbant material (silica gel). It is also recommended to return the LEDs to the original moisture proof bag and to reseal it again (fold the open bag firmly shut and keep in a dry environment).

Soldering:

Reflow Soldering			Hand Soldering	
	Lead Solder	Lead-free Solder		
Pre-heat	120 ~ 150°C	180 ~ 200°C	Temperature	350°C Max.
Pre-heat Time	120sec. Max.	120sec. Max.	Soldering Time	3sec. Max. (one time only)
Peak Temperature	240°C Max.	260°C Max.		
Soldering Time	10sec. max.	10sec. Max.		
Condition	Refer to Temperature-profile 1	Refer to Temperature-profile 2		

* After reflow soldering rapid cooling should be avoided.

Temperature-profile (Surface of circuit board):

Use the following conditions shown in the figure.

<1 : Lead Solder>

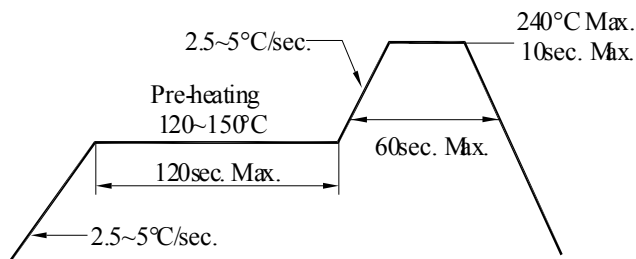

<2 : Lead-free Solder>

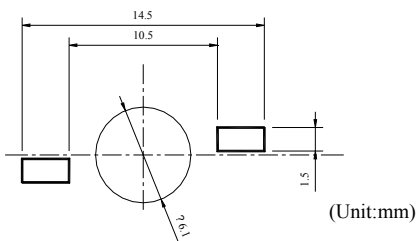
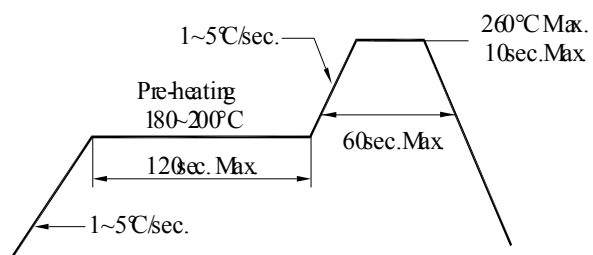

Important Notice: This data sheet and its contents (the "Information") belong to the members of the Premier Farnell group of companies (the "Group") or are licensed to it. No licence is granted for the use of it other than for information purposes in connection with the products to which it relates. No licence of any intellectual property rights is granted. The Information is subject to change without notice and replaces all data sheets previously supplied. The Information supplied is believed to be accurate but the Group assumes no responsibility for its accuracy or completeness, any error in or omission from it or for any use made of it. Users of this data sheet should check for themselves the Information and the suitability of the products for their purpose and not make any assumptions based on information included or omitted. Liability for loss or damage resulting from any reliance on the Information or use of it (including liability resulting from negligence or where the Group was aware of the possibility of such loss or damage arising) is excluded. This will not operate to limit or restrict the Group's liability for death or personal injury resulting from its negligence. Multicomp is the registered trademark of the Group. © Premier Farnell plc 2011.

www.element14.com

www.farnell.com

www.newark.com

