

NEW

OMRON

Pushbutton Switches/Indicators  
A22R/M22R series



Robust and Graceful design

# Pushbutton Switches

This document provides information mainly for selecting suitable models. Please read the document Instruction Sheet carefully for information that the user must understand and accept before purchase, including information on warranty, limitations of liability, and precautions.

OMRON Corporation  
Industrial Automation Company  
Sensing Devices Division H.Q.  
Industrial Sensors Division  
Shiokoji Horikawa, Shimogyo-ku,  
Kyoto, 600-8530 Japan  
Tel: (81)75-344-7022/Fax: (81)75-344-7107

Regional Headquarters

OMRON EUROPE B.V.  
Wegalaan 67-69-2132 JD Hoofddorp  
The Netherlands  
Tel: (31)2356-81-300/Fax: (31)2356-81-388

OMRON ELECTRONICS LLC  
One Commerce Drive Schaumburg,  
IL 60173-5302 U.S.A.  
Tel: (1) 847-843-7900/Fax: (1) 847-843-7787

OMRON ASIA PACIFIC PTE. LTD.  
No. 438A Alexandra Road # 05-05/08 (Lobby 2),  
Alexandra Technopark, Singapore 119967  
Tel: (65) 6835-3011/Fax: (65) 6835-2711

OMRON (CHINA) CO., LTD.  
Room 2211, Bank of China Tower,  
200 Yin Cheng Zhong Road,  
PuDong New Area, Shanghai, 200120, China  
Tel: (86) 21-5037-2222/Fax: (86) 21-5037-2200

© OMRON Corporation 2009 All Rights Reserved.  
In the interest of product improvement,  
specifications are subject to change without notice.

Printed in Japan  
1009

OMRON Industrial Automation Global: [www.ia.omron.com](http://www.ia.omron.com)

Cat. No. A190-E1-01

Push Button

Secure and Human-centered



Authorised Distributors:-

**Intech Systems Chennai Pvt. Ltd**

S-2, Thiru. Vi. Ka. Industrial Estate, Guindy, Chennai-600 032

Ph: 4353 8888 Mob: 99 4353 8888 (Board Line) Fax: 044 4353 7888

E-mail: [info@intechchennai.com](mailto:info@intechchennai.com) Website: [www.intechchennai.com](http://www.intechchennai.com)

realizing



Responds with **high grade** illumination to **various needs**

**1** Shining Metal Ring

Provides shining and robust metal ring.



**2** Soft to the touch

Gentle design for human.



**3** Additional unit type

Switch unit can be added.



**4** Compact size

The body length under a panel decreased by 15% compare with our former products.

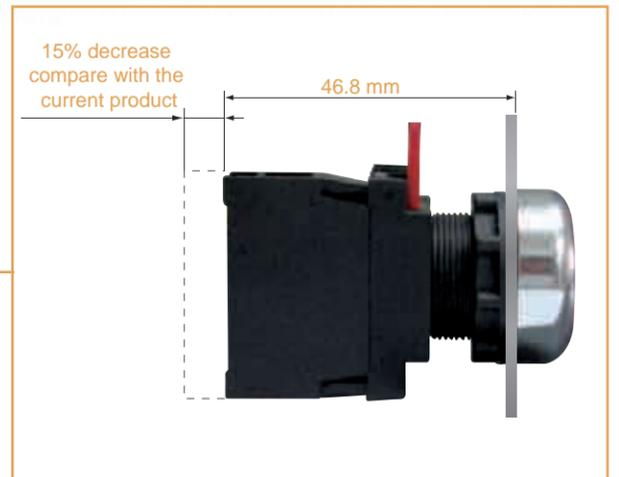

# Assembled Models

# Operation Units

## Non-lighted Type



Flat type  
A22R-F□-□□      Projection type  
A22R-T□-□□

## Lighted Type



Projection type  
A22RL-T□-□-□□

## Non-lighted Type



Flat type  
A22R-F□-□      Projection type  
A22R-T□-□

## Lighted Type



Projection type  
A22RL-T□-□

## Selector Non-lighted Type



2 notches  
A22RS-2□-□      3 notches  
A22RS-3□-□

## Selector Lighted Type



2 notches  
A22RW-2□□-□-□      3 notches  
A22RW-3□□-□-□

## Selector Non-lighted Type



2 notches  
A22RS-2□      3 notches  
A22RS-3□

## Selector Lighted Type



2 notches  
A22RW-2□□      3 notches  
A22RW-3□□

## Key Selector Type



2 notches  
A22RK-2□-□      3 notches  
A22RK-3□-□

## Indicator



Indicator  
M22R-E□-□

## Emergency Stop Switch



\*Emergency  
A22E-□-□-□-□

## Key Selector



2 notches  
A22RK-2□      3 notches  
A22RK-3□

## Switch Unit



Switch with Lamp socket  
A22RL-□M-□

## Socket



Socket  
A22R-□M

## Switch Block



Switch block  
A22R-□

## Lamp Socket



Lamp socket  
A22R-□

## Mounting Plate



Mounting plate  
A22R-3200

## LED



LED  
A22R-□□

\* Refer to the Safety Components Series Catalog (Cat. No. Y106) for detail.

# Assembled Models

# Assembled Models

## Pushbutton Switches

● Non-lighted/Lighted

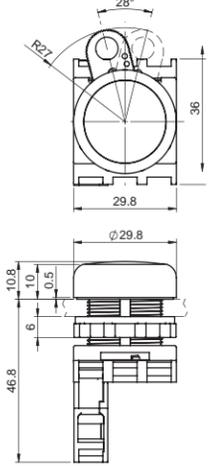
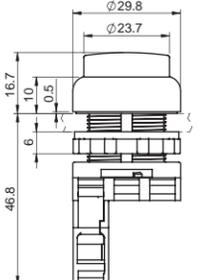
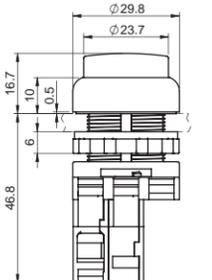
Appearance	Pushbutton shape	Pushbutton color	Contact form	Part No.	Dimensions
	Round/Flat		1a	A22R-FW-10□	
			1a	A22R-FB-10□	
			1a	A22R-FG-10□	
			1a	A22R-FR-10□	
			1a	A22R-FY-10□	
			1a	A22R-FA-10□	
			1b	A22R-FB-01□	
			1b	A22R-FR-01□	
		Insert one of the following letters into the box □. M: Momentary A: Alternate			
	Projection		1a	A22R-TW-10□	
			1a	A22R-TB-10□	
			1a	A22R-TG-10□	
			1a	A22R-TR-01□	
			1a	A22R-TY-10□	
			1a	A22R-TA-10□	
			1b	A22R-TB-01□	
	1b	A22R-TR-01□			
Insert one of the following letters into the box □. M: Momentary A: Alternate					
	Projection AC, DC 24V		1a	A22RL-TW-24A-10□	
			1a	A22RL-TG-24A-10□	
			1a	A22RL-TR-24A-10□	
			1a	A22RL-TY-24A-10□	
			1a	A22RL-TA-24A-10□	
	Projection AC 220V		1a	A22RL-TW-T2-10□	
			1a	A22RL-TG-T2-10□	
			1a	A22RL-TR-T2-10□	
			1a	A22RL-TY-T2-10□	
			1a	A22RL-TA-T2-10□	
		Insert one of the following letters into the box □. M: Momentary A: Alternate			

## Selector Switches

● Non-lighted/Lighted

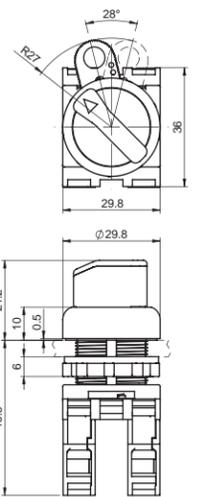
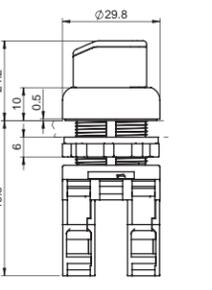
Appearance	Number of notch	Knob position	Knob color	Contact form	Part No.	Dimensions
	2 notches			1a	A22RS-2M-10	
				1a1b	A22RS-2M-11	
				1a	A22RS-2A-10	
				1a1b	A22RS-2A-11	
	3 notches			2a	A22RS-3M-20	* These Non-lighted types provide black knobs.
				2a	A22RS-3A-20	
				2a	A22RS-3M-20	
				2a	A22RS-3A-20	
	2 notches AC, DC 24V			1a	A22RW-2MG-24A-10	
				1a1b	A22RW-2MR-24A-11	
				1a	A22RW-2AY-24A-10	
				1a1b	A22RW-2AA-24A-11	
	3 notches AC, DC 24V			2a	A22RW-3MG-24A-20	
				2a	A22RW-3MR-24A-20	
				2a	A22RW-3AY-24A-20	
				2a	A22RW-3AA-24A-20	

## Assembled Models

## Structure

### Selector Switches

#### ● Key Selector

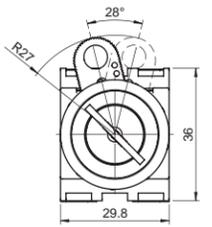
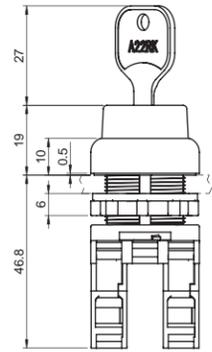
Appearance	Number of notch	Key position	Contact form	Part No.	Dimensions
	2 notches		1a	A22RK-2ML-10	
			1a1b	A22RK-2ML-11	
			1a	A22RK-2M-10	
			1a1b	A22RK-2M-11	
			1a	A22RK-2AL-10	
			1a1b	A22RK-2AL-11	
○: key release position					
	3 notches		2a	A22RK-3ML-20	
			2a	A22RK-3M-20	
			2a	A22RK-3MC-20	
			2a	A22RK-3AC-20	
			○: key release position		

### A22R series

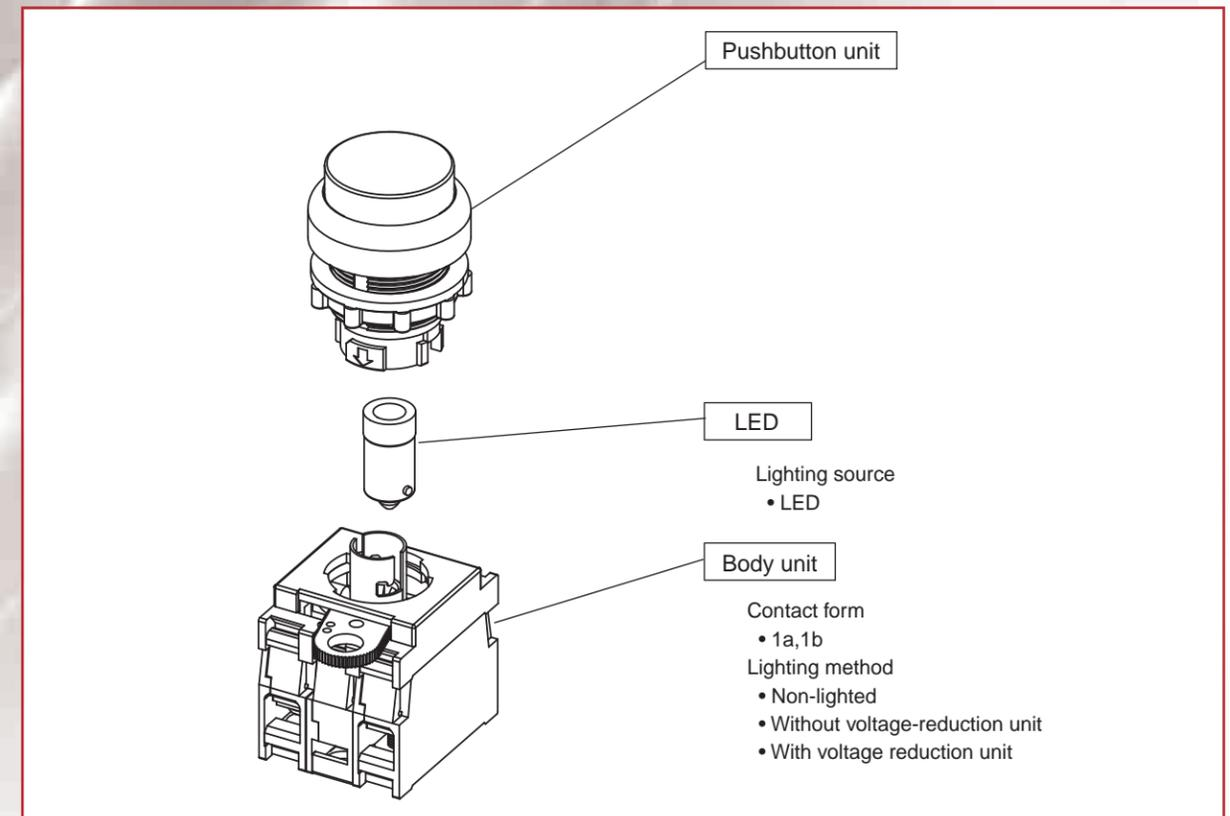

### Indicator

#### ● All-in-one type

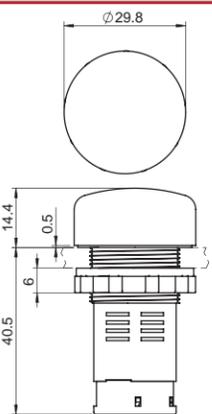
Appearance	LED rating	Indicator color	Part No.	Dimensions
	AC, DC 24V	○	M22R-EW-24A	
		●	M22R-EG-24A	
		●	M22R-ER-24A	
		●	M22R-EY-24A	
		●	M22R-EA-24A	
	AC 220V	○	M22R-EW-T2	
		●	M22R-EG-T2	
		●	M22R-ER-T2	
		●	M22R-EY-T2	
		●	M22R-EA-T2	

### M22R series

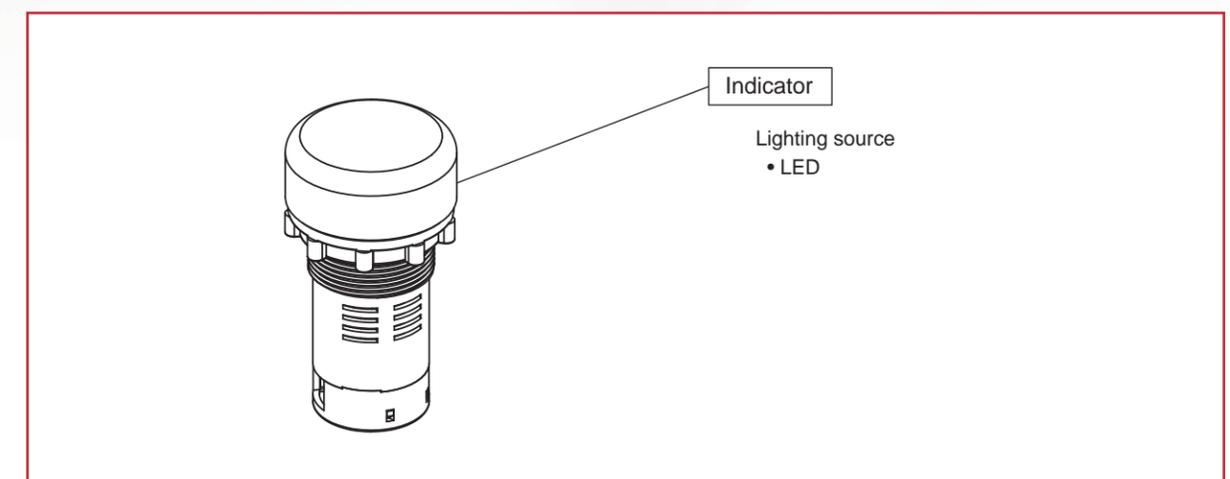

# Individual Unit

# Individual Unit

## Pushbutton unit

● Non-lighted/Lighted

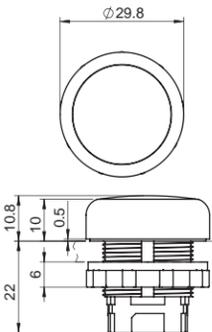
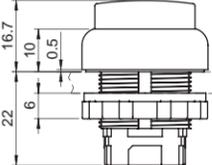
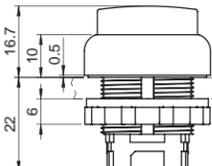
Appearance	Pushbutton shape	Pushbutton color	Part No.	Dimensions
	Round/Flat		A22R-FW-□	
			A22R-FB-□	
			A22R-FG-□	
			A22R-FR-□	
			A22R-FY-□	
			A22R-FA-□	
Insert one of the following letters into the box □. M: Momentary A: Alternate				
	Projection		A22R-TW-□	
			A22R-TB-□	
			A22R-TG-□	
			A22R-TR-□	
			A22R-TY-□	
			A22R-TA-□	
Insert one of the following letters into the box □. M: Momentary A: Alternate				
	Projection Lighted type		A22RL-TW-□	
			A22RL-TG-□	
			A22RL-TR-□	
			A22RL-TY-□	
			A22RL-TA-□	
		Insert one of the following letters into the box □. M: Momentary A: Alternate		

## Selector unit

● Non-lighted/Lighted

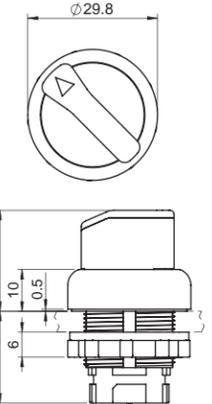
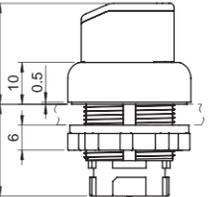
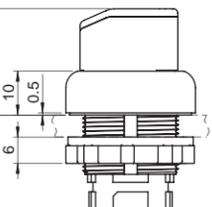
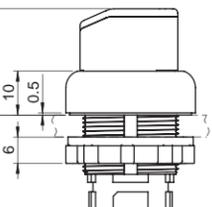
Appearance	Number of notch	Knob position	Knob color	Part No.	Dimensions
	2 notches			A22RS-2M	
				A22RS-2A	
	3 notches			A22RS-3M	
				A22RS-3A	
* These Non-lighted types provide black knobs.					
	2 notches Lighted Type			A22RW-2MG	
				A22RW-2MR	
				A22RW-2MY	
				A22RW-2MA	
				A22RW-2AG	
				A22RW-2AR	
	3 notches Lighted Type			A22RW-3AG	
				A22RW-3AR	
				A22RW-3AY	
				A22RW-3AA	
				A22RW-3AG	
				A22RW-3AR	

## Individual Unit

### Selector unit

#### ● Key Selector

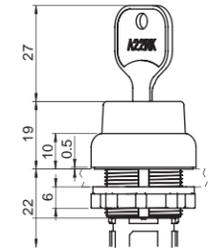
Appearance	Number of notch	Key position	Part No.	Dimensions
	2 notches		A22RK-2ML	 
			A22RK-2M	
			A22RK-2AL	
		○: key release position		
	3 notches		A22RK-3ML	
			A22RK-3M	
			A22RK-3MC	
			A22RK-3AC	
		○: key release position		

### Switch unit

#### ● For Lighted type

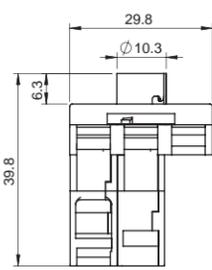
Appearance	Type	Contact form	Part No.	Dimensions
	Standard	1a	A22RL-10M	
		1b	A22RL-01M	
		2a	A22RL-20M	
		2b	A22RL-02M	
		1a1b	A22RL-11M	
	AC 220V	1a	A22RL-10M-T2	
		1b	A22RL-01M-T2	
		2a	A22RL-20M-T2	
		2b	A22RL-02M-T2	
		1a1b	A22RL-11M-T2	

#### ● For Non-lighted type

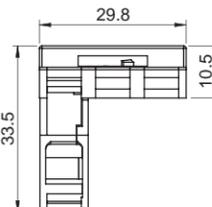
Appearance	Type	Contact form	Part No.	Dimensions
	Socket	1a	A22R-10M	
		1b	A22R-01M	
		2a	A22R-20M	
		1a1b	A22R-11M	
		2b	A22R-02M	

## Individual Unit

### Switch / Lamp units

#### ● Switch unit

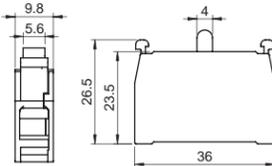
Appearance	Unit	Contact form	Part No.	Dimensions
	Contact block	1a	A22R-10	
		1b	A22R-01	
* Additional one block can be mounted to make 2a, 2b, or 1a1b.				

#### ● Lamp socket

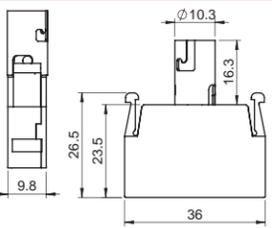
Appearance	Unit	Rating	Part No.	Dimensions
	Lamp socket	Without voltage reduction unit AC/DC6V, AC/DC12V, AC/DC24V	A22R-TN	
		With voltage reduction unit AC220V	A22R-T2	

### Mounting plate

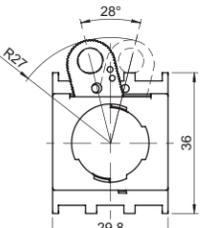
Appearance	Unit	Part No.	Dimensions
	Mounting plate	A22R-3200	

# Individual Unit

# Nomenclature

## Lamp unit

● LED

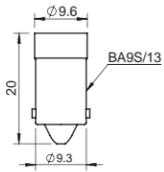
Appearance	LED operating voltage	Lighting color	Part No.	Dimensions
	LED AC/DC6V		A22R-6AW	
			A22R-6AG	
			A22R-6AR	
			A22R-6AY	
			A22R-6AA	
	LED AC/DC12V		A22R-12AW	
			A22R-12AG	
			A22R-12AR	
			A22R-12AY	
			A22R-12AA	
	LED AC/DC24V		A22R-24AW	
			A22R-24AG	
			A22R-24AR	
			A22R-24AY	
			A22R-24AA	

## Nomenclature

● Completely Assembled A22R□-□□-□-□□ Pushbutton switches

A 2 2 R □ - □ □ - □ - □ □

① Lighting    ② Pushbutton Shape    ③ Lighting Color    ④ Light Source    ⑤ Contact Form    ⑥ Switch Operation

Code	Lighting	Code	Shape	Code	Color	Code	Operating Voltage	Code	Contact Form	Code	Switch Operation
Blank	Non-lighted	F	Flat *	R	Red	Blank	No light source	10	1a	M	Momentary action
L	Lighted	T	Projection	G	Green	6A	AC/DC6V	01	1b	A	Alternate action
				Y	Yellow	12A	AC/DC12V	11	1a1b		
				W	White	24A	AC/DC24V	20	2a		
				A	Blue			02	2b		
				B	Black *						

\* For Non-lighted type only

④ Light Source

Code	Operating Voltage
T2	AC220V

● Use AC/DC24V LED

● Completely Assembled A22R□-□□-□-□ Selector switches

A 2 2 R □ - □ □ - □ - □

① Lighting    ② Number of Notches/Reset Method    ③ Lighting Color    ④ Light Source    ⑤ Contact Form

Code	Lighting	Code	Specification	Code	Color	Code	Operating Voltage	Code	Contact Form
S	Non-lighted	2M	2 notches/Manual	Blank	Black*	Blank	No-lighted type	10	1a**
		2A	2 notches/Automatic	R	Red	6A	AC/DC6V	01	1b**
		3M	3 notches/Manual	G	Green	12A	AC/DC12V	11	1a1b
		3A	3 notches/Automatic	Y	Yellow	24A	AC/DC24V	20	2a
		3MA	3 notches/Manual – left side, Automatic – right side	A	Blue			02	2b
		3AM	3 notches/Automatic – left side, Manual – right side						

\* Non-lighted type only

④ Light Source

Code	Operating Voltage
T2	AC220V

● Use AC/DC24V LED

\*\* For models with 2 notches

● Completely Assembled A22RK-□-□ Key selector switches

A 2 2 R K - □ - □

① Number of Notches/Reset method    ② Contact Form

Code	Number of notches, Reset method, Key release position	Code	Contact Form
2ML	2 notches, Manual, Left	10	1a**
2M	2 notches, Manual, Left and Right	01	1b**
2AL	2 notches, Automatic, Left	11	1a1b
3ML	3 notches, Manual, Left	20	2a
3M	3 notches, Manual, Left and Right	02	2b
3MC	3 notches, Manual, Center		
3AC	3 notches, Automatic, Center		
3MAL	3 notches, Manual – left, Automatic – right, Left		
3AMR	3 notches, Automatic – left, Manual – right, Right		

\*\* For models with 2 notches

● Completely Assembled M22R-□□-□ Indicator

M 2 2 R - □ □ - □

① Structure    ② Lighting Color    ③ Light Source

Code	Type	Code	Lighting Color	Code	Operating Voltage
E	All-in-one type	R	Red	12A	AC/DC12V
		G	Green	24A	AC/DC24V
		Y	Yellow		
		W	White		
		A	Blue		

③ Voltage Reduction Unit

Code	Operating Voltage
T2	AC220V

# Individual Unit

# Nomenclature

## Nomenclature

● Individual unit (Pushbutton unit) A22R□-□□-□ Pushbutton switches

A 2 2 R □ - □ □ - □

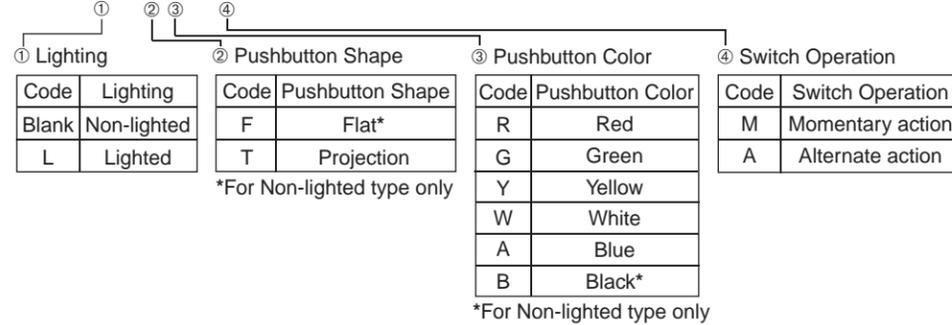

● Individual unit (Selector unit) A22R□-□□ Selector switches

A 2 2 R □ - □ □

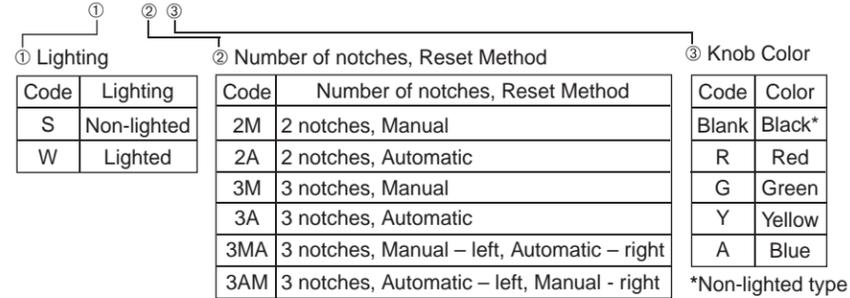

● Individual unit (Key selector unit) A22RK-□ Key selector switches

A 2 2 R K - □

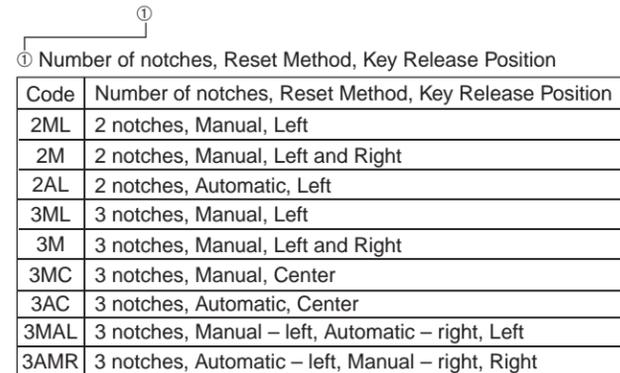

## Nomenclature

● Individual unit (Switch unit) A22R□-□M-□

A 2 2 R □ - □ M - □

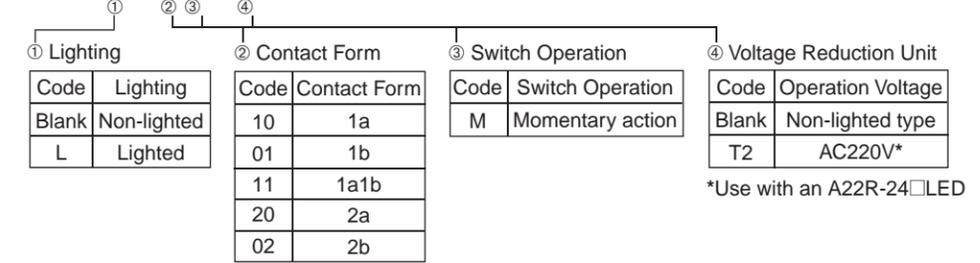

● Individual unit (Switch block) A22R-□

A 2 2 R - □

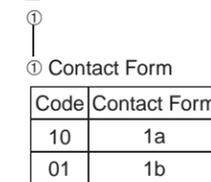

● Individual unit (Voltage-reduction unit) A22R-□

A 2 2 R - □

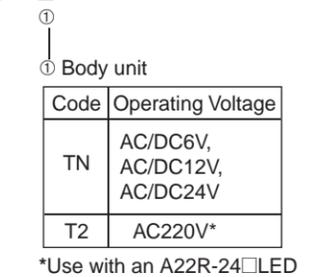

● Individual unit (LED) A22R-□□ LED

A 2 2 R - □ □

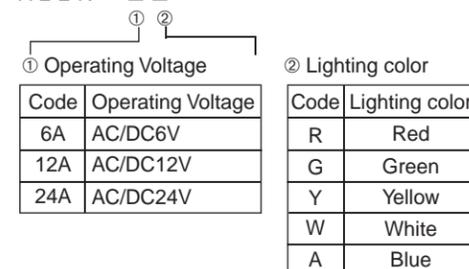

## Accessories / Tools

### Items

#### ● Accessories

Item	Appearance	Classification	Part No.	Remarks		
Legend Plate Frames	Standard size 	With Snap-in Legend Plate (without text)	White	A22Z-3321	Snap-in Legend Plate is acrylic.	
			Red	A22Z-3322		
			Black	A22Z-3323		
	Large size 	With Snap-in Legend Plate (without text)	White	A22Z-3331		Snap-in Legend plate is acrylic.
			Red	A22Z-3332		
			Black	A22Z-3333		
		Without Snap-in Legend Plate	A22Z-3320			
		Without Snap-in Legend Plate	A22Z-3330			
Lock Ring		Round	A22Z-3360	The Lock Ring is used when more secure lock feature is required.		
Sealing Caps		For flat models	A22Z-3600F	Used to prevent dust or water from entering the Operation Unit (Pushbutton, etc.). Color: opaque Material: silicon		
		For projection models	A22Z-3600T			
Hole plug		Round	A22Z-3530	Can be plugged into pre-cut panel holes for future expansion. The color is black.		
Control Boxes		One hole	A22Z-B101	Material: Polycarbonate resin.		
		Two holes	A22Z-B102			
		Three holes	A22Z-B103			
Connectors		Applicable diameter (mm)	ø7~9	A22Z-3500-1	Plastic connector used to extend a cable from the Switch Box. (See page 30)	
			ø9~11	A22Z-3500-2		

## Accessories / Tools

### Items

#### ● Accessories

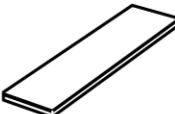
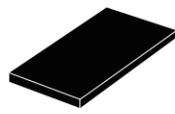
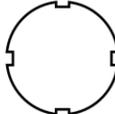
Item	Appearance	Classification	Part No.	Remarks			
Legend Plates	Standard size 	Without text	Black	A22Z-3443B	Attached to the Standard Plate Frame. Material: Acrylic.		
			Red	A22Z-3443R			
			White	A22Z-3443W			
			Transparent	A22Z-3443C			
		With text	White text on red background	○		A22Z-3443R-2	
				STOP		A22Z-3443R-4	
			White text on black background			A22Z-3443B-1	
				START		A22Z-3443B-3	
				ON		A22Z-3443B-5	
				OFF		A22Z-3443B-6	
	Large size 	Without text	Black	A22Z-3453B		Attached to the Large-size Legend Plate Frame. Material: Acrylic.	
			Red	A22Z-3453R			
			White	A22Z-3453W			
	Character Films		No print (Round)			A22Z-3460	After printing on a film, affix to the indicator Plate of the Lighted Pushbutton Switch. (The back is coated with adhesive.)
			Character Print (Round)			A22Z-3460-1	
○				A22Z-3460-2			
START				A22Z-3460-3			
STOP			A22Z-3460-4				

#### ● Tools

Item	Appearance	Part No.	Remarks
Lamp Extractor		A22Z-3901	Rubber tool used to easily replace Lamps.
Tightening wrench		A22Z-3905	Tool used to tighten nuts from the back of the panel.

## Specifications

### Approved standards

#### ● Switch unit

UL, cUL	UL 508/CSA C22.2 No.14 File No. E76675 6A 240VAC/10A 120VAC
EN	EN60947-5-1 (low voltage directive) 3A 240VAC (AC-15)
CCC	GB/14048.5-2001 3A 240VAC/1.5A 24VDC

#### ● Lamp unit

UL, cUL	UL 508/CSA C22.2 No.14 File No. E76675 24VAC/DC MAX
---------	---

#### ● Voltage-reduction unit

UL, cUL	UL 508/CSA C22.2 No.14 File No. E76675 220VAC
CCC	GB/14048.5-2001 220VAC

#### ● Indicator

UL, cUL	UL 508/CSA C22.2 No.14 File No. E76675 12A: 12VAC/DC 24A: 24VAC/DC T2 : 220VAC
CCC	GB/14048.5-2001 T2 : 220VAC

### Ratings

#### ● Contacts

Rated current (A)	Rated voltage (V)	Inductive load	
		Rated current (A)	Power factor
10	240	3	0.4

Rated current values are determined according to the testing conditions. The above ratings were obtained by conducting tests under the following conditions:

Ambient temperature: 20±2°C

Ambient humidity: 65±5%RH

Operating frequency: 30 operations/minute

#### ● LED (For pushbutton unit)

Operating voltage	Current consumption
AC/DC 6V±5%	20mA
AC/DC 12V±5%	20mA
AC/DC 24V±5%	20mA

#### ● LED (For indicator unit)

Operating voltage	Current consumption
AC/DC 12V±5%	20mA
AC/DC 24V±5%	20mA

#### ● Voltage reduction unit (For pushbutton and indicator units)

Operating voltage	Current consumption
AC 200V(190 to 230V)	20mA

### Characteristics

#### ● Environment

Ambient temperature*1	Non-lighted type: -20 to +60°C Lighted type: -20 to +50°C
Ambient humidity	-35 to 85%RH
Storage temperature*1	-40 to +70°C
Protective code*2	IP65
Vibration resistance	10 to 55Hz, Double amplitude 1.5mm
Shock resistance	Non-lighted type: 1,000m/s <sup>2</sup> Lighted type: 600m/s <sup>2</sup>

\*1: With no icing or condensation

\*2: Protection against dust or water from the front of a mounting panel side

#### ● Operation

Operation	Slow action	
Operating frequency	Mechanical	Momentary operation: 60 operations/minute max.
	Electrical	Knob-type and Key-type selector: 30 operations/minute max.
Mechanical durability	Momentary switch :3,000,000 operations Alternate, Key/Knob Selector switches: 300,000 operations	

#### ● Electrical Characteristics (Switch block)

Insulation resistance	100MΩ Minimum (At 500VDC)
Dielectric strength	Between terminals of same polarity: AC2,500V 50/60Hz for 1 minute Between terminals of different polarity: AC2,500V 50/60Hz for 1 minute
Rating	AC-15, A600, Ue=240V, Ie=3A
Rated insulation voltage	Ui=600V, Pollution degree: 3
Conditional short-circuit current	10A, IEC60209-1
Electrical durability	500,000 operations Minimum (at AC 240V, 3A, cosφ=0.4)

## Characteristics

# Characteristics

# Terminal

## Operating characteristics

● Pushbutton switch (1a1b)

<b>Total Travel Force (TTF)</b>	29.4N Maximum
<b>Total Travel (TT)</b>	5.5mm Maximum

● Knob-type selector switch (1a1b)

<b>Total Travel Force (TTF)</b>	Manual reset: 0.34N·m Maximum * Auto-reset 2-notch: 0.25N·m * 3-notch: 0.34N·m *
<b>Total Travel (TT)</b>	2-notch: approx. 90 degree (3-notch: approx.45 degree)
<b>Releasing Force (RF)</b>	Manual reset: 0.34N·m Maximum *

\* Rotation torque for knob type/key type selector switches.

● Key-type selector switch (1a1b)

<b>Total Travel Force (TTF)</b>	Manual reset: 0.34N·m Maximum * Auto-reset 2-notch: 0.25N·m * 3-notch: 0.34N·m *
<b>Total Travel (TT)</b>	2-notch: approx. 90 degree (3-notch: approx.45 degree)
<b>Releasing Force (RF)</b>	Manual reset: 0.34N·m Maximum *

\* Rotation torque for knob type/key type selector switches.

## Terminal Arrangement

● Bottom view (unit: mm)

No-lighted (1a1b)	Lighted	Indicator

## Terminal connection

Type	Terminal connection
Non-lighted (1a1b)	<p>BOTTOM VIEW</p>
Lighted without voltage reduction unit (1a1b)	<p>BOTTOM VIEW</p> <p>* LED: For AC/DC</p>
Lighted with voltage reduction unit (1a1b)	<p>BOTTOM VIEW</p>

# Precautions

## Precautions

### Warning

Do not wire and/or touch the switch terminal while power is supplied to the switch to avoid electric shock.

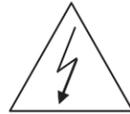

### Correct Use

#### ● Mounting

- Always make sure that the power is turned OFF before mounting, removing, or wiring the Switch, or performing maintenance.
- Do not tighten the mounting ring more than necessary using tools such as pointed-nose pliers. Doing so will damage the mounting ring. The tightening torque is 0.98 to 1.96N-m.
- Recommended panel thickness: 1 to 5 mm.

#### ● Wiring

- Terminal screws must be Phillips with a square washer.
- The tightening torque is 1.08 to 1.27N-m.
- Single wires, stranded wires and crimp terminals except round type can be connected to the Switch.
- Applicable Wire Size

Strand wire: 2mm<sup>2</sup> Maximum

Solid wire: 1.6mm diameter Maximum

Bare Crimp Terminals

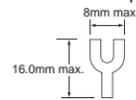

Crimp Terminal with Insulating Sheath

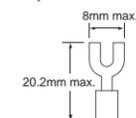

- Secure appropriate insulation distance after wiring of the Switch.
- Perform wiring so that the lead wires will not be caught on other objects as this will cause stress on the Switch terminals. Wire the Switch so that there is slack in the lead wires and fix lead wires at intermediate points. If the panel to which the Switch is mounted needs to be opened and closed for maintenance purpose, perform wiring so that the opening and closing of the panel will not interfere with the wiring.

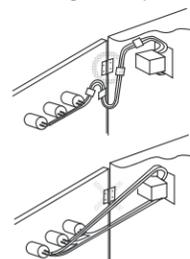

#### ● Operational Environment

- The IP65 model is designed with a degree of protection so that it will not sustain damage if it is subject to water from any direction to front of the panel.
- This Switch is indoor use only. Outdoor use of the Switch will cause operation failure of the Switch.
- Do not use the Switch in the water, oil, or in locations where water, oils, detergent, chemicals, or solvent is applied to the Switch always. Otherwise, switching failure will be happened.
- Do not use the Switch under the environmental condition where corrosive gas (ammonia, chlorine, dioxide sulfur...etc.) is generated. Otherwise, the Switch will corrode.
- Do not use the Switch in locations where dust, metal or plastic dust exists. Dust will accumulate on the Switch, and then the Switch wouldn't operate normally.
- Do not use the Switch under the environmental condition where excessive vibration or shock exists. Otherwise, incorrect switching would occur.

#### ● Electrical Conditions

- The switching load capacity of the Switch greatly varies between AC and DC. Always be sure to apply the rated load. The control capacity will drastically drop if it is a DC load. This is because a DC load has no current zero-cross point, unlike an AC load. Therefore, if an arc is generated, it may continue for a comparatively long time. Furthermore, the current direction is always the same, which results in a contact relocation phenomena whereby the contacts easily stick to each other and do not separate when the surfaces of the contacts are uneven.
- Some types of load have a great difference between normal current and inrush current. Make sure that the inrush current is within the permissible value. The greater the inrush current in the closed circuit is, the greater the contact abrasion or shift will be. Consequently, contact weld, contact separation failures, or insulation failures may result. Furthermore, the Switch may be broken or damaged.
- If the load is inductive, counter-electromotive voltage will be generated. The higher the voltage is, the higher the generated energy will be, which increase the abrasion of the contacts and contact relocation phenomena. Be sure to use the Switch within the rated conditions.

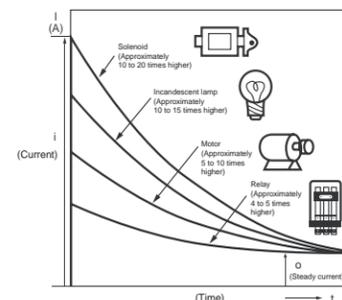

- Before using the Switch, be sure to test the Switch under actual conditions.
- This product is a standard load type Switch. Using the Switch for opening and closing a microload circuit may cause contact failure. Use the Switch within the operating range as shown in below chart.

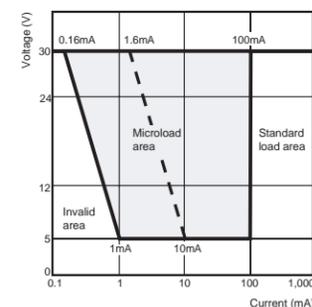

- When use the Switch for opening and closing a microload or large-load, use the Switch with an appropriate relay.

## Precautions

#### ● Switching

- Do not use the Switch for loads that exceed the rated switching capacity or other contact ratings. Doing so may result in contact weld, separation failure, or insulation failures. Furthermore, the Switch may be broken or damaged.
- Do not touch the charged switch terminals while power is supplied, otherwise an electric shock may be received.
- The life of the Switch varies greatly with switching conditions. Before using the Switch, be sure to test the Switch under actual conditions. Make sure that the number of switching operations is within the permissible range. If a deteriorated Switch is used continuously, insulation failures, contact weld, contact failures, switch damage, or switch burnout may result.
- Do not apply excessive or incorrect voltages to the Switch or incorrectly wire the terminals. Otherwise, the Switch may not function properly and have an adverse effect on external circuitry. Furthermore, the Switch itself may become damaged or burnt.
- Do not use the Switch in locations where flammable or explosive gasses are present. Otherwise switching arcs or heat radiation may cause a fire or explosion.
- Do not drop or disassemble the Switch, otherwise it may not be capable of full performance. Furthermore, it may be broken or burnt.

#### ● LED

- The LED current-limiting resistor is built-in, so internal resistance is not required.
- If commercially available LEDs are used, select the ones that meet the following conditions:  
Base: BA9S/13□  
Overall length: 26mm Maximum  
Power consumption: 2.6 W Maximum

#### ● Storage

- When the Switch is left unused or stored for long periods, the ambient conditions can have a great effect on the condition of the Switch. In certain environments, leaving the Switch exposed may result in deterioration (i.e., oxidation, or the creation of an oxide film) of the contacts and terminals, causing the contact resistance to increase, and making it difficult to solder the lead wires. Therefore, store in a well-ventilated room, inside, for example, a non-hygroscopic case, in a location where no corrosive gasses are present.
- If the Switch is stored in a location where it will be exposed to direct light, colored resin in the colored plate may fade. Therefore, do not store the Switch in locations where it will be exposed to direct light.

#### ● Mechanical Conditions

- Operating the Switch using a hard object (e.g., metal), or with a large or sudden force, may deform or damage the Switch, resulting in faulty or rough operation, or shortening of the Switch life.

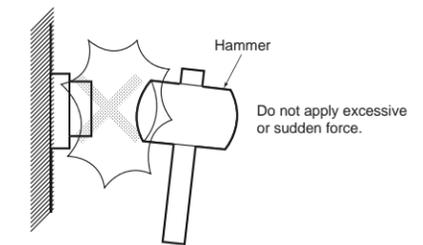

- The pushbutton surface is composed of resin. Therefore, do not attempt to operate the pushbutton using a sharp object, such as a screwdriver or a pair of tweezers. Also, do not drop, throw, or knock the Switch. Doing so may damage or deform the pushbutton surface and result in faulty operation.

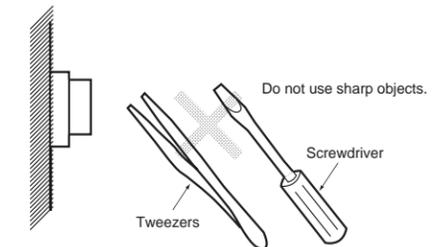

- Periodic maintenance is required to use the Switch stably.

# Installation

# Installation

## Mounting to the Panel

### ① Panel Hole Dimensions

- The cutout dimensions are as shown in below:

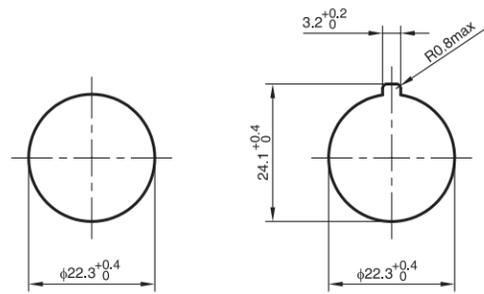

When Lock Ring is not used.

When Lock Ring is used.

- Recommended panel thickness is 1 to 5mm.
- In outer surface treatment such as coating is performed for the panel, the panel dimensions after outer surface treatment must meet the specified panel dimensions.

### ② Matrix Installation

- (1) The following panel hole dimensions apply when Switch Unit and the Standard-size Legend Plate Frame and Lock Ring are mounted, and lead wires are connected directly to the Switch Block.

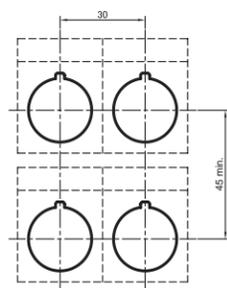

- (2) The following panel hole dimensions apply when the Large-size Legend Plate Frame is mounted, and when crimp terminals are connected to the Switch Block terminals.

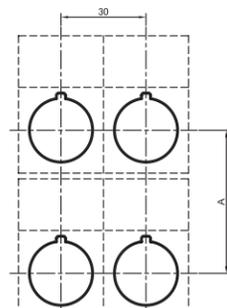

Type of crimp terminal	Dimension A
Bare crimp terminals	51 mm Minimum
Crimp terminals with insulating sheath	60 mm Minimum

**Note:** The above dimensions are the minimum dimensions for when the wires described under "Applicable Wire Size". If a different wires are used, the wiring dimensions may be different so determine an appropriate pitch before setup.

### ③ Mounting the Operation Unit on the Panel

- Insert the Operation Unit (Pushbutton, etc.) from the front surface of the panel, insert the Lock Ring and the mounting nut from the terminal side, then tighten the nut. Before tightening, check that the rubber washer is present between the Pushbutton Unit and the panel.
- When using a Legend Plate Frame, put one rubber washer each between the Legend Plate Frame and the panel and between the Operation Unit and the Legend Plate Frame. (One rubber washer will be provided when one Legend Plate Frame is ordered.)
- Align the Lock Ring with the groove in the casing, then insert the Lock Ring so that its edge is located on the panel side.
- Tighten the mounting nut at a torque of 0.98 to 1.96N·m.
- When using a Lock Ring, replace with the supplied Lock Ring, insert the projecting part into the lock slot, and then tighten the mounting nut.

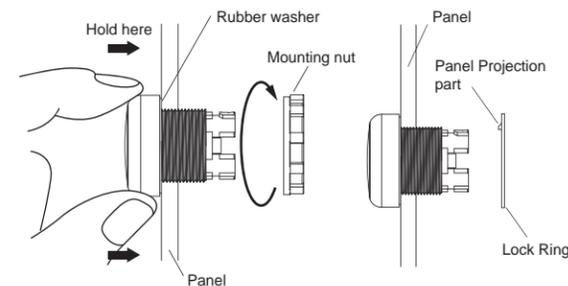

### ④ Mounting the Switch on the Pushbutton Unit

- Insert the Pushbutton Unit into the Switch Unit, aligning the arrow mark inscribed on the Case with the lever on the Switch Blocks, then move the lever in the direction indicated by the arrow in the following figure.

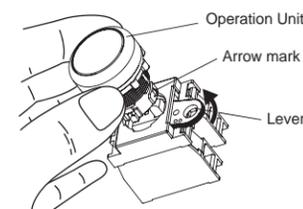

### ⑤ Removing the Switch

- Move the lever in the direction indicated by the arrow in the following figure, then pull the Pushbutton Unit or the Switch Blocks.
- Since the lever has a hole with an inside diameter of 6.5mm, the lever can be moved in the specified direction by inserting a screwdriver into the hole and then moving the screwdriver.

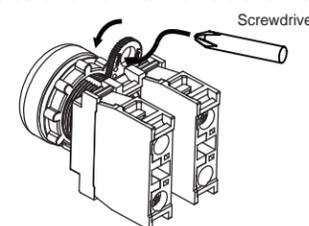

## How to confirm the Lever Position, OPEN or LOCK

- The Lever Position, OPEN (Operation unit is not fixed)/LOCK (Operation unit is fixed), can be confirmed from the Switch terminal side.

In case that no switch block is mounted on the mounting plate No.1.

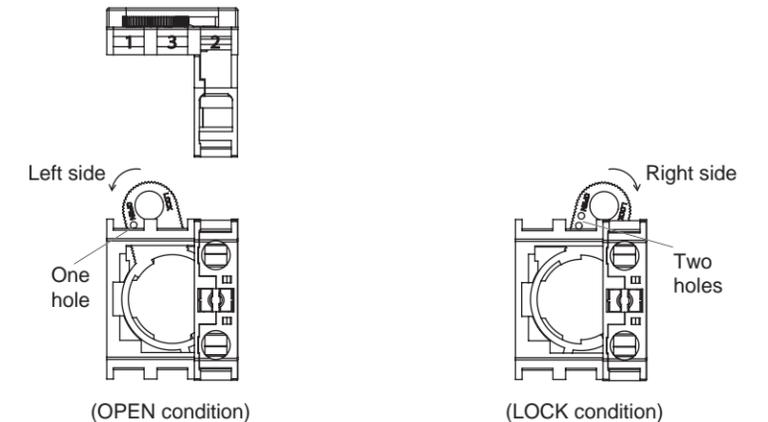

In case that a switch block is mounted on the mounting plate No.1.

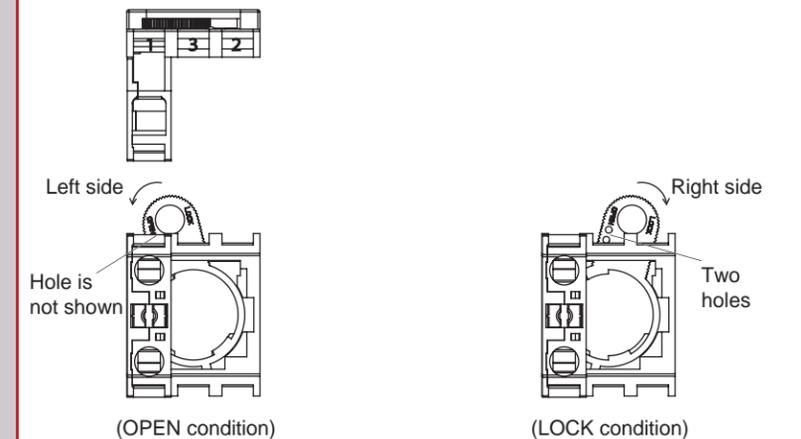

In case that a switch block is mounted on the mounting plate No.1 and an indicator unit is mounted on the mounting plate No.2.

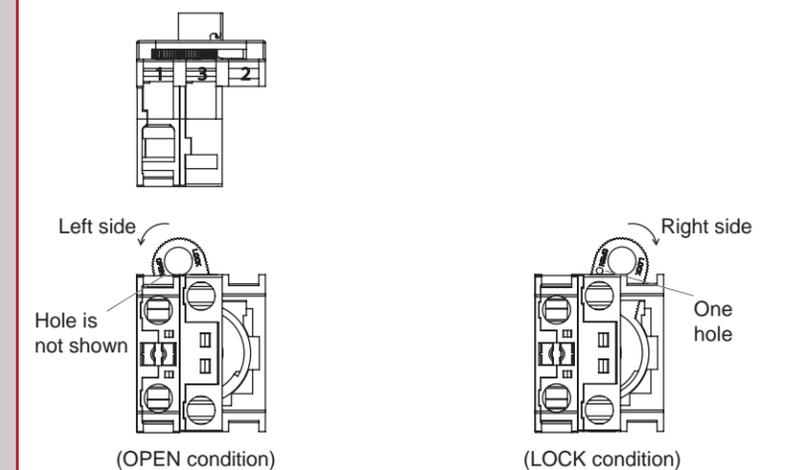

# Installation

# Installation

## Mounting/Replacing the Color Cap

### Projection type

- Grip and rotate the Color Cap with your fingers.

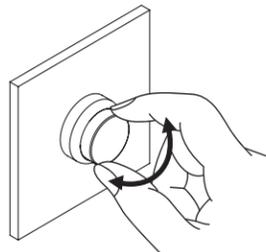

## Assembling the Cap

### ① Projection type Lighted Pushbutton Switch

- Mount the Color Cap so that the protrusions inside the cap fit into the grooves in the Pushbutton Unit.

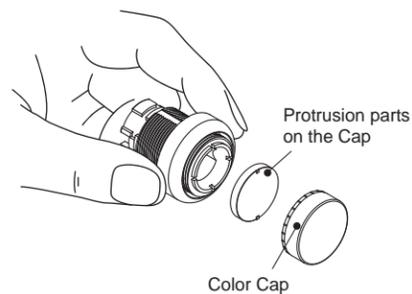

### ② Indicator

- Mount the Color Cap so that the protrusions inside the Pushbutton Unit fit into the grooves in the cap.

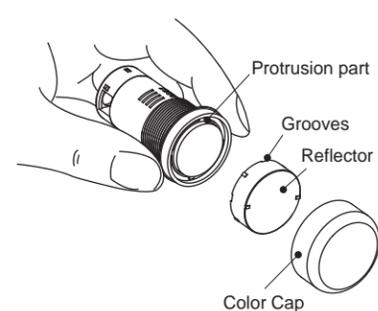

## Installing/Replacing the LED

### ① Installing/Replacing from the Panel Surface

- Insert the Lamp Extractor (A22Z-3901) into the lamp, then rotate the Extractor while pressing it.

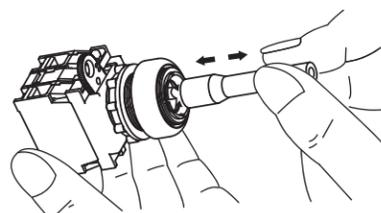

### ② Installing/Replacing on the Switch

- Grip the lamp with your fingers, then rotate the lamp while pressing it against the Switch.

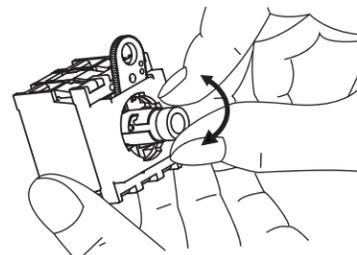

## Mounting/Replacing the Switch Unit and Indicator Unit

### ① Installing the Switch Blocks

- Mount the Unit according to the indicate numbers on the Mounting Plate.

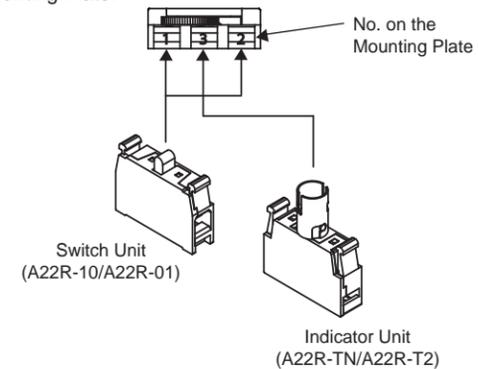

- Hook the small protrusion on the Switch Block into the groove on the Mounting Latch on the other side of the lever, then push up the Switch Block in the direction indicated by the arrow in the figure below:
- One more Switch Block can be mounted.

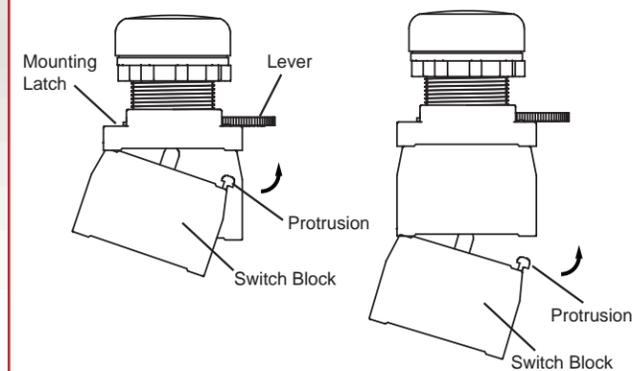

**Note:** In case that two Switch Block are mounted, a Control Box cannot be used.

### ② Removing the Switch Base

- Insert a screwdriver between the Mounting Latch and the Switch Block, then push down the screwdriver in the direction indicated by the arrow in the following figure.

Use the following screwdrivers.  
 ⊖ Flat-head screwdriver  
 3mm Maximum

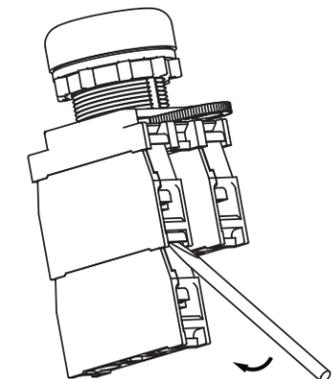
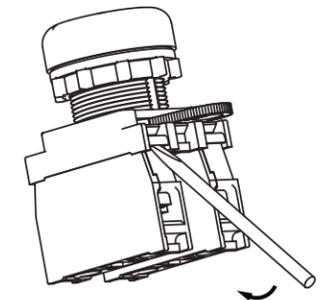

# Installation

## Control Box

### ① Mounting the Switch

The Standard-size Legend Plate Frame can be mounted. Mount the Switch in the same way as for an ordinary panel.

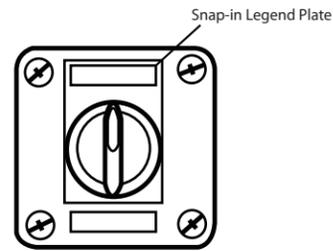

### ② Creating a Cable Port Hole

Place the tip of a screwdriver on the surface where the cable port hole is to be created with the cover attached and strike the screwdriver to punch a hole. Attempts to punch a hole on the other side of the case will damage the Box.

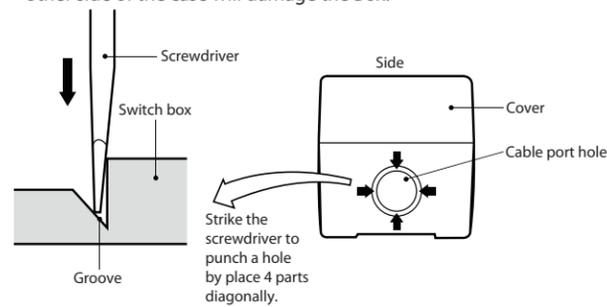

### ③ Securing the Connector Cable

- ① Insert the connector into the cable port in the Box and secure with the fixing nut inside the box.
- ② Open a hole in the thin rubber section of the rubber ring.
- ③ Pass the tightening cap through the cable, insert the cable into the connector, and tighten the hexagonal nut to secure the cable.

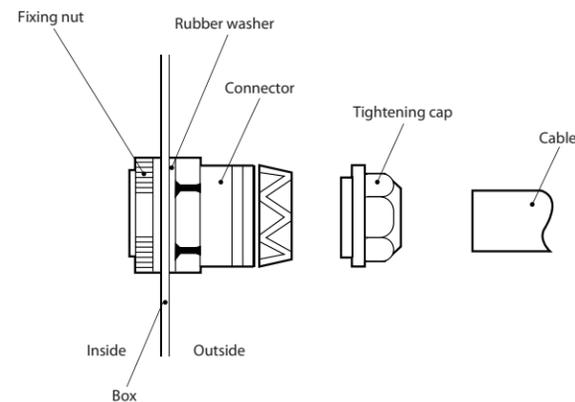

Cable diameter (mm)	Connector
7 to 9 mm dia.	A22Z-3500-1
9 to 11 mm dia.	A22Z-3500-2

# Installation

## Engraving

- Engrave the characters on the surface on the Cap. Make sure that the characters are aligned parallel to the imaginary line connecting the two protruding portions to the left and right of the Cap.
- The characters must not be engraved deeper than 0.5mm. Apply an alcohol-based paint coating, such as melamine, alkyd, or acrylic resin paint coating, to the engraved characters.

Protruding portions of the Cap



### Material: Acrylic

- Engrave the characters directly on the matted side of the Snap-in Legend Plate.
- The characters must be engraved no deeper than 0.5mm.
- Apply alcohol-based paint coating to the engraved characters.
- If the Snap-in Legend Plate is transparent, engrave the mirror-written characters on the back of the Snap-in Legend Plate and apply paint coating of a different color to the remaining part of the Snap-in Legend Plate.

## Affixing Character Film

- Hold the Cap, remove the cardboard or the Film, and attach the Film to the Cap. Make sure that the protruding portions of the Cap engage the cutout portions of the Film and that the characters are aligned parallel to the imaginary line connecting the two protruding portions to the left and right of the Cap.



## Mounting and Dismounting Snap-in Legend

- Press and secure the Snap-in Legend Plate onto the Legend Plate Frame.
- The direction of the characters will vary with the mounting direction of the control panel if the Switch is a knob or key selector model.

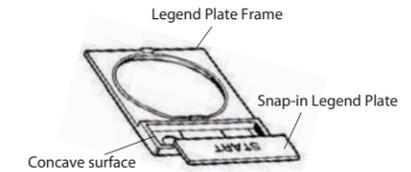

- To easily remove the Snap-in Legend Plate from the Legend Plate Frame mounted to the panel. Insert a Tool with a thin tip into the space between the Snap-in Legend Plate and the Legend Plate Frame.



- The Snap-in Legend Plate is easily removed by pressing the Snap-in Legend Plate from the back of the Legend Plate Frame.
- The Legend Plate Frame is made of acrylic resin, which is easily damaged by shock. Be sure to handle the Legend Plate Frame with care.

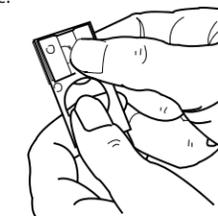

## Precautions when use the indicators

- Lock Ring (A22Z-3360) cannot be used.
- When use the Legend Plate Frames (A22Z-332 @, A22Z-333 @) cut the projection portions shown in the below fig.

- When use the Control Box (A22Z-B10 @), cut the projection portions shown in the below fig.

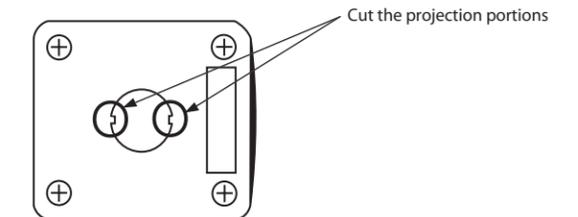
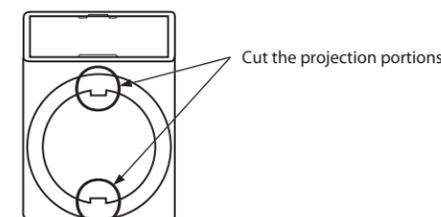

Authorised Distributors:-

**Intech Systems Chennai Pvt. Ltd**

S-2, Thiru. Vi. Ka. Industrial Estate, Guindy, Chennai-600 032

Ph: 4353 8888 Mob: 99 4353 8888 (Board Line) Fax: 044 4353 7888

E-mail: info@intechchennai.com Website: www.intechchennai.com