

## MULTI-BEAM XL Power Distribution Connector System

### Board Mount Connectors

#### Product Facts

- Single-piece molded housings
- Custom configurable modular design
- AC and DC power in the same connector — Meets UL safety requirements
- Current Interrupt ratings per UL 1977 — for “Hot-Plug” applications
- Compact size — ideal for distributed DC power applications
- Molded-in guide pins provide generous blind-mateability
- Up to 3 levels of contact sequencing:
  - 1st — Pwr/Gnd
  - 2nd — Pwr & Signals
  - 3rd — Trigger Signals
- Low Mating and Un-mating force
- Solder or press-fit termination to PCB
- Meets SSI power connector requirements for DPS, MPS and HPS applications
- 30 micro-inch [0.76 micro-meters] gold post-plated contacts for high reliability
- All MULTI-BEAM XL products in this section are RoHS compliant

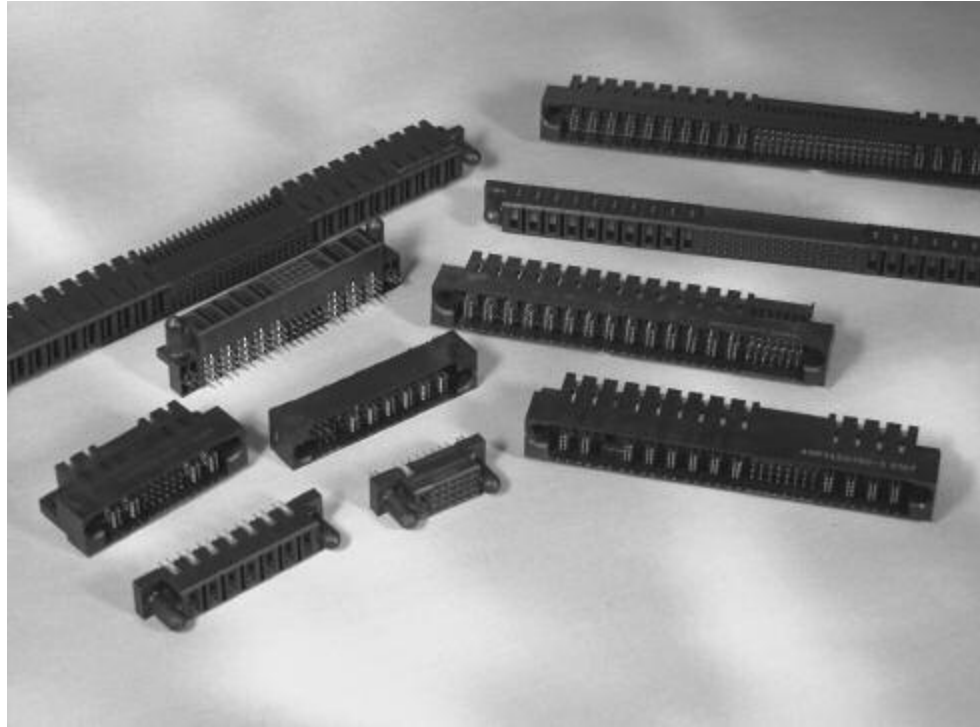

MULTI-BEAM XL is a blind-mateable board-to-board power distribution connector system. The heart of the MULTI-BEAM XL connector is the unique power contact which offers higher current ratings, lower contact resistance and lower mating forces than alternative designs. The connector is designed and manufactured in a modular approach and therefore allows the customer to select the number of power and signal contacts as well as the mating sequence of contacts they need for their specific application.

The product is also available in versions complying to the Server Systems Infrastructure (SSI) Standard. The MULTI-BEAM XL product offers high reliability and high current density in a package designed specifically for modular hot-swappable power distribution systems.

MULTI-BEAM XL connectors are ideal for blind-mating in modular and rack mounted systems. The high performance design and heavy gold plated contacts meet requirements across many applications including Power Distribution for

compact (1U) computer servers up through High-End Servers, Fault-tolerant Computers, Networking Equipment, Telecommunication Switches, Medical Instrumentation and Industrial Control equipment.

The compact design also meets the I/O needs of modern Modular and Hot-Swappable redundant (N+1) Power Supplies and Uninterruptible Power Supplies.

#### Technical Documents

Product Specifications —  
108-1973

Application Specification —  
114-13038

 File # E28476

 File # LR7189

#### For More Information

Internet  
<http://tycoelectronics.com>

Check out product information at:  
<http://mbxl.tycoelectronics.com>

Technical Support Center  
1-800-522-6752

**MULTI-BEAM XL Power Distribution Connector System** (Continued)

Board-to-Board Products

**Board Mount Connectors**

**Power Contacts**

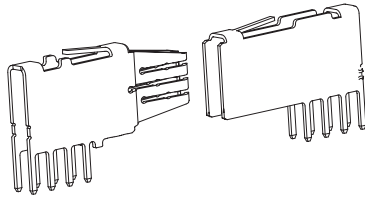

**Signal Contacts**

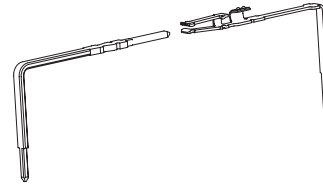

- Improved MULTI-BEAM XL power contact design features eight independent beams which provide:
  - Electrical performance — Parallel current paths yield a lower contact resistance
  - Mechanical performance — Tuned beam design provides low mating forces and high durability life cycles
  - Traditional Dual-Beam design also available
- Twin-beam signal receptacle contact design mates on milled surface, to reduce plating wear / and improve durability
- MULTI-BEAM XL connector assures you of **EXTRA LONG CONTACT WIPE**
  - Power contacts feature up to 0.200" [5.08mm] minimum wipe
  - Shortest "trigger" signal contacts feature a minimum wipe of 0.100" [2.54mm]

- MULTI-BEAM XL connectors provides **EXPANDABLE LENGTH** connectors
  - Overall length is expandable to accommodate up to 36 power contacts
  - Contact spacings are expandable to accommodate higher voltages and/or higher current requirements
- Base metal made from high conductivity copper alloy (over 98% copper) offers superior performance compared to alternative materials (brass, phosphor bronze, beryllium copper, etc.) often used in power connectors
- 0.100" [2.54mm] x 0.100" [2.54mm] PCB contact grid

**Application Flexibility**

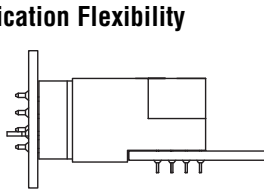

**Vertical Receptacle Right Angle Plug**

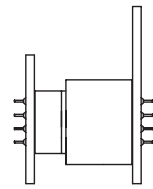

**Vertical Receptacle Vertical Plug**

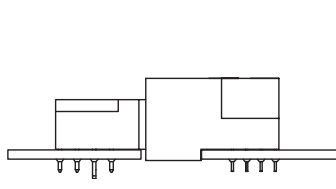

**Right Angle Receptacle Right Angle Plug**

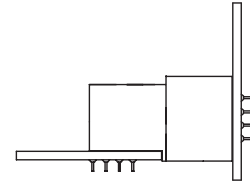

**Right Angle Receptacle Vertical Plug**

**Contact Wipe**

Contact Type	Description	Sequence	Minimum Wipe
Power (or GND) Contact	Make First Break Last (MFBL)	1	0.200" [5.08mm]
Power Contact	Standard	2	0.150" [3.81mm]
Signal Contact	Standard	2	0.150" [3.81mm]
Signal (trigger) Contact	Make Last Break First (MLBF)	3	0.100" [2.54mm]

The MLBF power contact and the Standard Signal contact are sequenced to mate at the same time ... sequence #2.

**Product Configurations and Part Numbers**

The connector configuration is described by reading Left-to-Right on the Plug mating interface and Right-to-Left on the Receptacle mating interface. Custom configurations can be produced due to the modular design of the product. Some popular configurations are shown in the tables below.

**Configuration Description:** ACP indicates AC Power, P indicates DC Power, HDP indicates High Density Power, S indicates Signal. The corresponding contact spacing and voltage ratings are shown below.

ACP	P	HDP	S
0.300" [7.62mm] spacing	0.250" [6.35mm] spacing	0.200" [5.08mm] spacing	0.100" [2.54mm] grid
300 Volts*	200 Volts*	Connection to same voltage*	60 Volts*

\* With circuit board designed to UL 1950, IEC 60950

**MULTI-BEAM XL Power Distribution Connector System** (Continued)

**Board Mount Connectors**
**Right Angle Receptacles**

Configuration *	Part Number	Application	Overall Length " and [mm]	PCB Tail Type (Solder, Press-Fit)	Power Contact Sequencing
1P/24S/1P	6450160-3	SSI "DPS"	1.925" [48.90mm]	Solder	No
2P/24S/2P	1-6450160-0	Distributed DC Power + Signal	2.250" [57.15mm]	Solder	No
3P/24S/3P	6450570-2	Distributed DC Power + Signal	2.750" [69.85mm]	Press-fit	Yes
3ACP/24S/5P	6450170-2	AC and DC Power + Signal	3.400" [86.36mm]	Solder	Yes
3ACP/24S/6P	6450170-8	AC and DC Power + Signal	3.650" [92.71mm]	Solder	Yes
5P/24S/6P	6450160-5	SSI "MPS"	4.350" [110.49mm]	Solder	No
5P/32S/5P	6450560-2	Distributed DC Power + Signal	3.950" [100.33mm]	Press-fit	No
7P/32S/7P	6450560-4	Distributed DC Power + Signal	4.350" [110.49mm]	Press-fit	No
8P/28S	6450172-2	Distributed DC Power + Signal	3.350" [85.09mm]	Solder	Yes
8P/32S/8P	6450160-1	AC and DC Power + Signal	5.450" [138.43mm]	Solder	No
10P/84S/10P	6450160-6	AC and DC Power + Signal	7.750" [196.85mm]	Solder	No
3ACP	6450173-1	AC Power	1.550" [39.37mm]	Solder	Yes
8P	6450163-2	DC Power	2.650" [67.31mm]	Solder	No
14P/32S	6450172-1	Distributed DC Power + Signal	4.950" [125.73mm]	Solder	Yes
16S/4P	6450161-1	Distributed DC Power + Signal	2.050" [52.07mm]	Solder	No
24S/6P	6450161-2	Distributed DC Power + Signal	2.750" [69.85mm]	Solder	No
24S/8P	6450161-6	Distributed DC Power + Signal	3.250" [82.55mm]	Solder	No

\* Custom configurations are available — see page 28 for instructions to have Tyco Electronics build your custom part.

**Vertical Receptacles**

Configuration *	Part Number	Application	Overall Length " and [mm]	PCB Tail Type (Solder, Press-Fit)	Power Contact Sequencing
1P/24S/1P	6450540-1	SSI "DPS"	1.925" [48.90mm]	Press-fit	No
2P/24S/2P	6450140-1	Distributed DC Power + Signal	2.250" [57.15mm]	Solder	No
3P/24S/3P	1-6450140-0	Distributed DC Power + Signal	2.750" [69.85mm]	Solder	No
4P/24S/4P	6450150-6	Distributed DC Power + Signal	3.350" [85.09mm]	Solder	Yes
4P/24S/3ACP	6450150-3	AC and DC Power + Signal	3.150" [80.01mm]	Solder	Yes
3ACP/24S/5P	6450550-1	AC and DC Power + Signal	3.400" [86.36mm]	Press-fit	Yes
5P/24S/6P	6450540-2	SSI "DPS"	4.350" [110.49mm]	Press-fit	No
6P/24S/6P	4-6450550-5	Distributed DC Power + Signal	4.250" [107.95mm]	Press-fit	No
10P/84S/10P	6450140-4	Distributed DC Power + Signal	7.750" [196.85mm]	Solder	No
10P/24S/12P	3-6450550-2	Distributed DC Power + Signal	5.800" [147.32mm]	Press-fit	Yes
3P	6450543-1	DC Power	1.400" [35.56mm]	Press-fit	No
3ACP	6450543-6	AC Power	1.550" [39.37mm]	Press-fit	No
4P	6450543-5	DC Power	1.650" [41.91mm]	Press-fit	No
5P	6450553-1	DC Power	1.900" [48.26mm]	Press-fit	Yes
6P	6450553-2	DC Power	2.050" [52.07mm]	Press-fit	Yes
7P	6450543-3	DC Power	2.400" [60.96mm]	Press-fit	No
8P/28S	6450142-3	Distributed DC Power + Signal	3.350" [85.09mm]	Solder	No
14P/32S	6450152-1	Distributed DC Power + Signal	4.950" [125.73mm]	Solder	Yes
24S/6P	6450551-1	Distributed DC Power + Signal	2.750" [69.85mm]	Press-fit	Yes
24S/3ACP	6450151-3	Distributed DC Power + Signal	2.200" [55.88mm]	Solder	Yes
24S/8P	6450541-5	Distributed DC Power + Signal	3.250" [82.55mm]	Press-fit	No

\* Custom configurations are available — see page 28 for instructions to have Tyco Electronics build your custom part.

**Note:** All part numbers are RoHS compliant.

**MULTI-BEAM XL Power Distribution Connector System** (Continued)

**Board Mount Connectors**
**Right Angle Plugs**

Configuration *	Part Number	Application	Overall Length " and [mm]	PCB Tail Type (Solder, Press-Fit)	Signal Contact Sequencing
1P/24S/1P	6450330-1	SSI "DPS"	1.925" [48.90mm]	Solder	Yes
2P/24S/2P	6450120-2	Distributed DC Power + Signal	2.250" [57.15mm]	Solder	No
3P/24S/3P	6450130-6	Distributed DC Power + Signal	2.750" [69.85mm]	Solder	Yes
4P/24S/3ACP	6450130-4	AC and DC Power + Signal	3.150" [80.01mm]	Solder	Yes
3ACP/24S/5P	6450130-3	AC and DC Power	3.400" [86.36mm]	Solder	Yes
3ACP/24S/6P	1-6450130-4	AC and DC Power + Signal	3.650" [92.71mm]	Solder	Yes
5P/24S/6P	6450230-1	SSI "DPS"	4.350" [110.49mm]	Solder	Yes
5P/32S/5P	2-6450120-4	Distributed DC Power + Signal	3.950" [100.33mm]	Solder	No
6P/24S/6P	2-6450120-7	Distributed DC Power + Signal	4.250" [107.95mm]	Solder	No
8P/32S/8P	6450120-1	Distributed DC Power + Signal	5.450" [138.43mm]	Solder	No
10P/84S/10P	6450120-6	Distributed DC Power + Signal	7.750" [196.85mm]	Solder	No
10P/24S/12P	4-6450130-6	Distributed DC Power + Signal	5.800" [147.32mm]	Solder	Yes
16S/4P	6450231-1	Distributed DC Power + Signal	2.050" [52.07mm]	Solder	Yes
24S/6P	6450131-7	Distributed DC Power + Signal	2.750" [69.85mm]	Solder	Yes
24S/3ACP	6450121-3	Distributed DC Power + Signal	2.200" [55.88mm]	Solder	No
3ACP	6450123-3	AC Power	1.550" [39.37mm]	Solder	N/A
3P	6450123-1	DC Power	1.400" [35.56mm]	Solder	N/A
4P	6450123-2	DC Power	1.650" [41.91mm]	Solder	N/A
5P	6450123-6	DC Power	1.900" [48.26mm]	Solder	N/A
6P	6450523-2	DC Power	2.050" [52.07mm]	Press-fit	N/A
7P	6450123-5	DC Power	2.400" [60.96mm]	Solder	N/A
8P/28S	6450132-3	Distributed DC Power + Signal	3.350" [85.09mm]	Solder	Yes
14P/32S	6450132-4	Distributed DC Power + Signal	4.950" [125.73mm]	Solder	Yes

\* Custom configurations are available — see page 28 for instructions to have Tyco Electronics build your custom part.

**Vertical Plugs**

Configuration *	Part Number	Application	Overall Length " and [mm]	PCB Tail Type (Solder, Press-Fit)	Signal Contact Sequencing
1P/16S/1P	6600333-9	Distributed DC Power + Signal	1.650" [41.91mm]	Press-fit	Yes
1P/24S/1P	6600330-4	SSI "DPS"	1.925" [48.90mm]	Solder	Yes
2P/16S/2P	1-6600333-0	Distributed DC Power + Signal	2.150" [54.61mm]	Press-fit	Yes
2P/24S/2P	1-6600333-2	Distributed DC Power + Signal	2.250" [57.15mm]	Press-fit	Yes
3P/16S/3P	6600333-7	Distributed DC Power + Signal	2.650" [67.31mm]	Press-fit	Yes
3ACP/24S/3ACP	1-6600333-1	AC Power + Signal	3.150" [80.01mm]	Press-fit	No
4P/24S/4P	6600333-6	Distributed DC Power + Signal	3.350" [85.09mm]	Press-fit	Yes
5ACP/24S/5ACP	6600333-1	Distributed DC Power + Signal	4.350" [110.49mm]	Press-fit	Yes
7P/32S/7P	6600330-5	Distributed DC Power + Signal	4.350" [110.49mm]	Solder	No
24S/8P	6600323-2	Distributed DC Power + Signal	3.250" [82.55mm]	Press-fit	No
3ACP	6450503-3	AC Power	1.550" [39.37mm]	Press-fit	N/A
8P	6600303-1	DC Power	2.650" [67.31mm]	Press-fit	N/A

\* Custom configurations are available — see page 28 for instructions to have Tyco Electronics build your custom part.

**Note:** All part numbers are RoHS compliant.

**MULTI-BEAM XL Power Distribution Connector System** (Continued)

**Board Mount Connectors**

**Specifications**

**Materials**

**Housing** — High temperature thermo-plastic, UL 94V-0

**Power Contacts** — High conductivity Copper alloy

**Signal Contacts** — Copper alloy

**Boardlocks** — Phosphor bronze

**Finish**

**Power and Signal Contacts** — 30 microinches [.76 micrometers] min. gold over 50 microinches [1.27 micrometers] min. nickel on mating surfaces, 100 microinches [2.54 micrometers] min. tin over 50 microinches [1.27 micrometers] min. nickel at PCB terminations

**Note:** Tin-lead plating also available on press-fit connectors

**Performance Specifications**

Up to 55 Amps per power contact, de-rated to 35 Amps in equally energized (8 adjacent positions) connector.

Up to 4 Amps per signal contact, de-rated to 1.5 Amps in equally energized 24-position pin field.

**Maximum Continuous Operating Temperature** — 105°C.

**Contact Resistance** — 0.7 milli-ohm

**Durability** — 250 cycle

**Radial Mis-alignment Capability** — ± 0.075" [1.91mm]

Minimum of 0.100" [2.45mm] of contact wipe on shortest signal contact

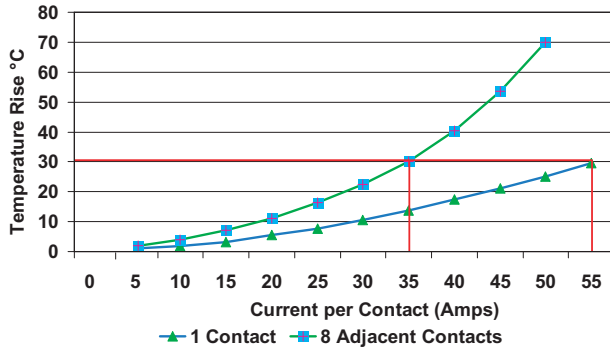

**Performance @ 30 Amps per Contact**

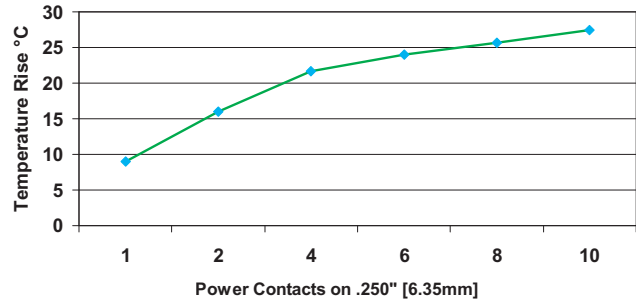

See Cable Connectors on Pages 18-27

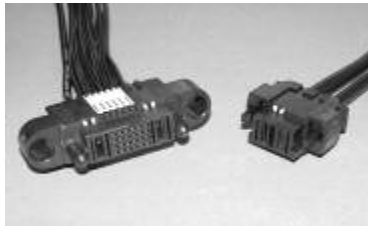
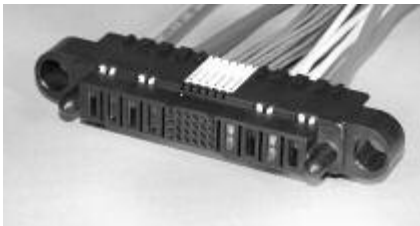



## “NEW” MULTI-BEAM XL Current Pass-Thru Power Distribution Connector System

### Product Facts

- Combines PCB and Cable mounted contacts
- Ideal for separating AC input from DC input
- Eliminates FASTON tab interface at the back of the connector housing
- Requires less space than two housing designs
- Terminates 14 AWG up to 8 AWG wire
- Mates with Tyco Electronics Vertical and Right Angle PCB plugs
- High strength housing materials
- RoHS Compliant

### Technical Documents

**Product Specification** —  
108-1973 and 108-2157

**Application Specification** —  
114-13038



The Cable Pass-Through MULTI-BEAM XL receptacles securely terminate up to a 10 AWG wire directly into MULTI-BEAM XL pcb mounted receptacles. The design includes a “terminal position assurance” (TPA) feature that ensures the manually inserted wires are fully seated. The product offers a unique way of using the MULTI-BEAM XL pcb receptacles as a sort of “docking” connector. A single docking connector is far easier to mate to and to design around in a blind-mate application, than multiple power and signal connectors. By separating

some circuits to be cable terminated and some to be pcb terminated it allows both high voltage (AC) and low voltage (DC) power to pass through the same connector.

This separation of the AC and DC power eliminates the concerns of high voltage power running through circuit boards better suited to carry only low voltage circuitry. Additional applications may include designs where the power is better routed directly to a different pcb, through cables, yet pass through a single docking connector for ease in system design.

The Cable Pass-Through connector is offered in both right angle or vertical pcb mount orientations and is supplied with either press-fit or solder pc tails. The connector is mate-able to either pcb mounted or cable mounted MULTI-BEAM XL or MULTI-BEAM XLE plugs. All MULTI-BEAM XL cable connectors are supplied pre-assembled by Tyco Electronics.

**“NEW” MULTI-BEAM XL Current Pass-Thru  
Power Distribution Connector System** (Continued)

Available Configurations	Part Numbers			
	Right Angle Receptacles	Right Angle Plugs	Vertical Receptacles	Vertical Plugs
3CP/1P/24S/2P	6450178-1	6450130-2	—	—
3CP/24S/2P	6450178-2	2-6450130-6	—	—
3CP/24S/3ACP	1888179-1	2-6450330-6	—	—
3CP/4P/24S	6450578-1	1-6450132-3	6450558-1	6600310-5
3ACP/24S/6P	—	1-6450130-4	6450558-2	—
3CP/8P/12S	1888132-1	—	—	—
3CP/20S/10P	6450578-2	6-6450130-2	—	—
3CP/16S	6450668-1	6450622-1	—	—

**Note:** Receptacles are the only MULTI-BEAM XL parts with Pass-Thru capability.

**Configuration Description**

CP	ACP	P	HDP	S
AC Power	AC Power	DC Power	High Density Power	Signal
Cable Power .300" spacing	PC Mount .300" spacing	PC Mount .250" spacing	PC Mount .200" spacing	PC Mount .100" grid

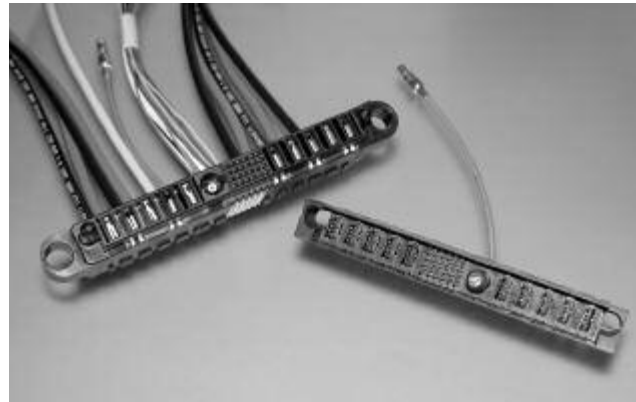

**“NEW” MULTI-BEAM XL Coax Pass-Thru  
Combine power, coax and signal all in one connector**

Right Angle Plug	Cable Receptacle
292495-1	292491-1

**Note:** All part numbers are RoHS compliant.

## MULTI-BEAM XL Power Distribution Connector System Cable Receptacle Assemblies

### Cable Receptacle Assemblies

#### Product Facts

- Single one-piece housing design
- Terminal Position Assurance (TPA) Secondary Locks on contacts assure no contact back-out
- Pre-assembled made-to-order cable assemblies
- Installation to panel provides float in X, Y and Z directions
- Insulation crimp on all contacts
- 30 microinch (.76 micrometers) gold plated contacts for high reliability
- Touch-safe design passes UL1977 and IEC 60950 finger probe test
- AC and DC power in the same connector — meets UL & IEC safety requirements
- All MULTI-BEAM XL products in this section are RoHS compliant

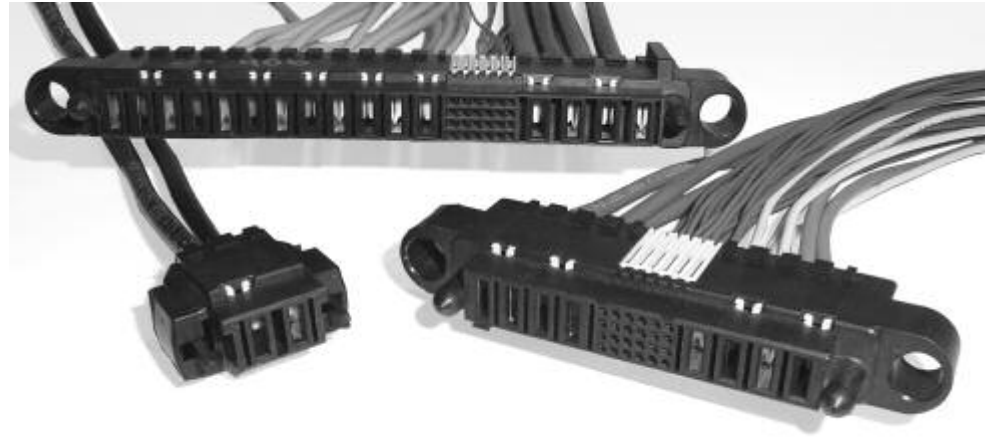

MULTI-BEAM XL Cable Assemblies allow designers freedom to connect power supplies and power distribution subassemblies in a wide variety of applications. Expanding beyond board-to-board applications the cable assemblies are available for both cable-to-board or panel mount applications and can terminate 8-16 AWG and 22-26 AWG wires all in one connector, without using adapter circuit boards. In addition, the power contacts are designed to be able to accept two-wire terminations which can further reduce harness complexity by reducing or eliminating mid-wire splices.

The use of high temperature glass filled housing materials, redundant contact retention and high conductivity contact materials allows the use of this connector in very high current density applications. The features work together to result in a highly durable and compact power connector, which offers industry leading minimum millivolt drop through the connection. The connector was designed to pass the UL 1977 and IEC 60950 finger probe test which makes the connector touch-safe. The insulation crimp adds further safety by keeping the insulation from being pulled away from the termination point. These features eliminate the

need for a secondary cable clamp which often can be size prohibitive.

The cable connectors are designed to mate to the de-facto standard Tyco Electronics MULTI-BEAM XL Right Angle or Vertical PCB Plugs. The combination of pcb and cable connections, both with mixed power and signal arrangements provides a universal power distribution connector systems.

The cable assemblies are all RoHS compliant, designed to specific customer requirements and manufactured in Tyco Electronics' cable assembly manufacturing facilities.

#### Technical Documents

Product Specification —  
108-2157

Application Specification —  
114-13112

#### For More Information

Internet <http://tycoelectronics.com>

Check out product information at: <http://mbxl.tycoelectronics.com>

Technical Support Center 1-800-522-6752



**MULTI-BEAM XL Power Distribution Connector System**  
**Cable Receptacle Assemblies** (Continued)

**Configurations/Applications**

**Floating XYZ Panel-Mount Receptacle**

- 0.060" [1.52] Nominal Float in X, Y and Z direction
- For modular installation of large power distribution systems
- Single connector replaces multiple power and signal connectors

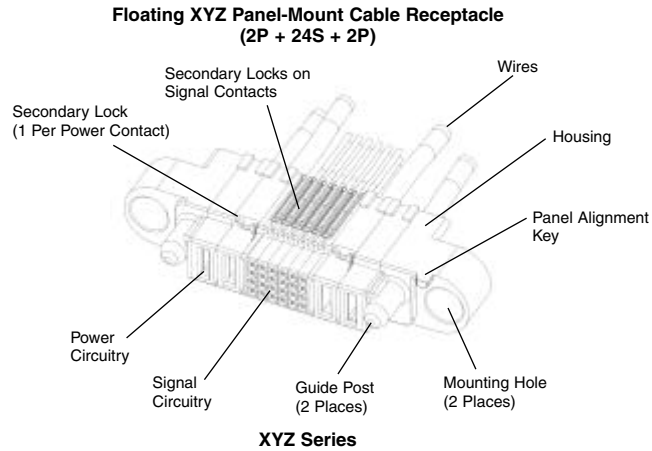

**Slide-to-Lock Receptacle**

- 0.030" [0.76] nominal float in X and Y direction
- Ideal for modular installation of smaller systems requiring less space and less float — such as fan trays
- Replaces connectors which use multiple low power contacts to carry the total current
- Power only or Power Plus signal mixed

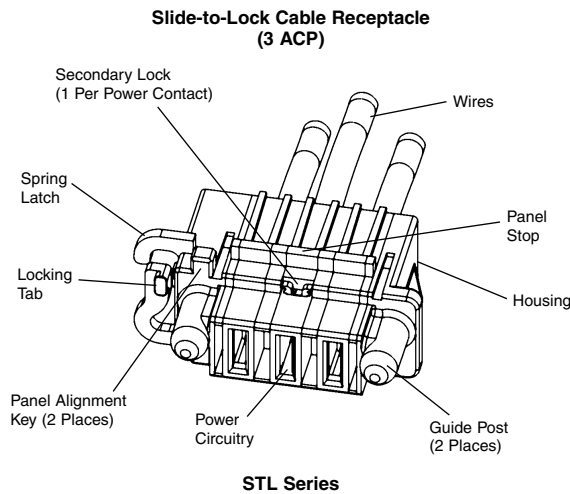

**Cable-to-Board Receptacle**

- Easy to mate/disconnect with squeeze-to-release latches
- Mates to right angle or vertical MULTI-BEAM XL STR plugs
- Replaces two traditional connectors (1 signal and 1 power) with just 1 connector

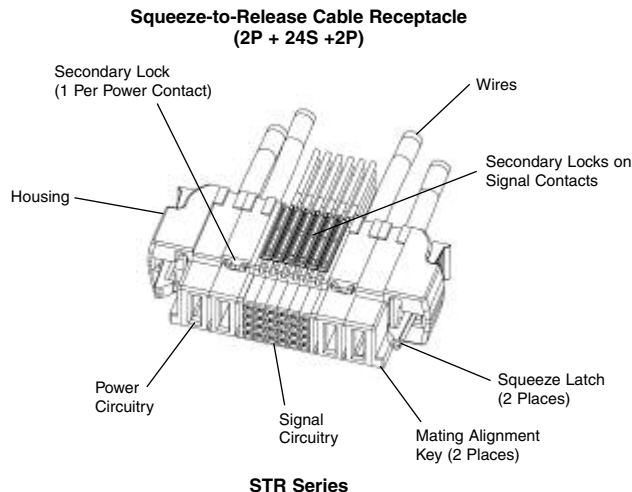

**MULTI-BEAM XL Power Distribution Connector System**  
**Cable Receptacle Assemblies** (Continued)

**Panel Mount Receptacles**

**Product Facts**

- High strength glass-filled housing materials
- Expandable/modular housing design
- PMT Series floats +/- 0.060" [1.52] in X, Y and Z directions
- STL series floats 0.030" [0.76] in X and Y directions
- Mounting Hardware Kits:  
Part Number 1600914-1 — Standard  
Part Number 1600914-3 — High Force

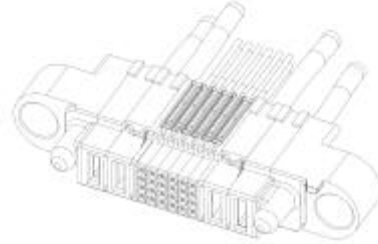

X, Y, Z Floating Receptacle

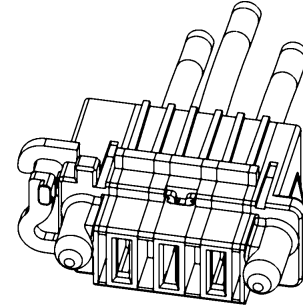

Slide-to-Lock Receptacle

**Power and Signal Module Specifications**

Power Module Widths:	Module Designation	Maximum Wire Size AWG [mm <sup>2</sup> ]	Max. Insulation Dia. inches [mm]
0.300 [7.62] (ACP)	300 (ACP)	8 [10.5]	0.272 [6.91]
0.250 [6.35] (P)	250 (P)	10 [6.6]	0.215 [5.46]
0.200 [5.08] (HDP)	200 (HDP)	12 [2.6]	0.156 [3.96]

  

Signal Module Width	Module Designation	Wire Range AWG [mm <sup>2</sup> ]	Insulation Range inches [mm]
0.200 [5.08] (8 Contacts)	Signals	22-26 [0.14-0.32]	0.036-0.054 [0.91-1.37]

Part numbers shown identify the main receptacle connector housing. Additional components (contacts, contact locks, etc.) are used to complete the cable assembly. See page 22 for contacts, secondary locks and application equipment information.

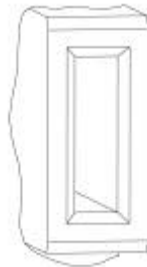

Power Module

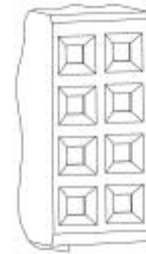

Signal Module

**Configurations/Part Numbers**

Available Configurations	Part Numbers			
	XYZ Series	STL Series	Mating PCB Plugs	
			Vertical	Right Angle
3ACP	1600606-2	292499-1	6450503-3	6450123-3
4P	—	292499-4	6600303-2	6450123-2
4ACP	—	292499-3	6600303-3	—
5P	1600606-1	1761419-2	—	6450123-6
1P/16S/1P	1-1600636-3	1761819-4	6600333-9	—
1P/24S/1P	1600636-9	—	6600330-4	6450330-1
2P/16S/2P	1-1600636-0	—	1-6600333-0	—
2P/24S/2P	1600636-2	1761819-2	6600333-5	1-6450330-4
3P/16S/3P	1600636-8	—	6600333-7	—
3ACP/24S/3ACP	1-1600636-4	—	1-6600333-1	—
4P/24S/4P	1-1600636-5	—	6600333-6	—
5ACP/24S/5ACP	1600636-1	—	6600333-1	5-6450130-0
7P/48S/7P	1-1600636-6	—	—	3-6450120-4

**Note:** All part numbers are RoHS compliant.

## MULTI-BEAM XL Power Distribution Connector System Cable Receptacle Assemblies (Continued)

### Cable-to-Board Squeeze-to-Release Receptacles

#### Product Facts

- High strength glass-filled housing
- Pre-installed squeeze-to-release latches.
- Expandable/Modular housing design
- Mates to Tyco Electronics Vertical or Right Angle PCB Plugs

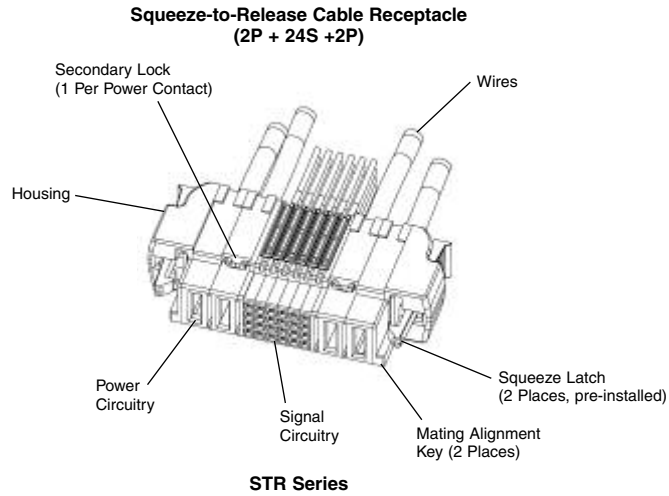

#### Technical Documents:

**Product Specification** —  
108-2157

**Application Specification** —  
114-13112

See page 22 for contacts, secondary locks and application equipment information.

#### Power and Signal Module Specifications

Power Module Widths:	Module Designation	Maximum Wire Size AWG [mm <sup>2</sup> ]	Max. Insulation Dia. inches [mm]
0.300 [7.62] (ACP)	300 (ACP)	8 [10.5]	.272 [6.91]
0.250 [6.35] (P)	250 (P)	10 [6.6]	.215 [5.46]
0.200 [5.08] (HDP)	200 (HDP)	12 [2.6]	.156 [3.96]
Signal Module Width	Module Designation	Wire Range AWG [mm <sup>2</sup> ]	Insulation Range inches [mm]
0.200 [5.08] (8 Contacts)	Signals	22-26 [0.14-0.32]	.036-.054 [0.91-1.37]

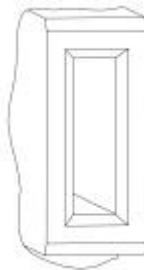

Power Module

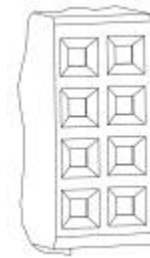

Signal Module

#### Configurations/Part Numbers

Available Configurations	STR Series	Part Numbers	
		Vertical	Right Angle
2ACP	1600798-2	6600393-1	6450129-1
3P	1600798-3	6600393-2	6450129-2
3ACP	1600798-5	—	—
4P	1600798-4	6600390-1	6450129-3
6P	1600798-1	6600393-3	—
1P/24S/1P	1600788-8	6600380-2	6450128-1
2P/8S/2P	1-1600788-3	—	6450128-6
2P/16S/2P	1-1600788-0	6600383-5	—
2P/24S/2P	1600788-1	6600383-3	6450128-2
3ACP/24S/3ACP	1-1600788-2	6600383-6	—
4P/24S/4P	1-1600788-4	6600383-7	6450128-5

**Note:** All part numbers are RoHS compliant.

**MULTI-BEAM XL Power Distribution Connector System**  
**Cable Receptacle Assemblies** (Continued)

Board-to-Board Products

**Cable Receptacle Components**

**Material and Finish**

**Body** — 50 micro inches Nickel over Tin

**Mating Area** — 30 micro inches Gold over Nickel

**Technical Documents**

**Product Specification**  
108-2157-1

**Application Specification**  
114-13164

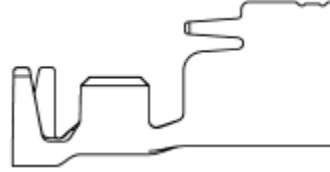

Power Contact

**Power Contacts**

Wire Size Range AWG	Insulation Diameter	Plating	Housing Width	Part Number	Applicator Tool
12	.156 Max. [3.96]	Tin	.200 or .250 [5.08 or 6.35]	1-1600961-7 (make-first-break-last)	1385635-3
	.156-.176 [3.96-4.47]	Tin	.250 [6.35]		1385636-3
14	.120-.156 [3.05-3.96]	Tin	.200 or .250 [5.08 or 6.35]	1-1600961-8 (Standard)	1385635-3
	.090 Max. [2.29]	Tin	.250 [6.35]		1385636-3

Wire Size Range AWG	Insulation Diameter	Plating	Housing Width	Part Number	Applicator Tool
8	.215-.272 [5.46-6.91]	Tin	.300 [7.62]	1-1600960-7 (make-first-break-last)	1385637-3
10	.176-.215 [4.47-5.46]	Tin	.200 or .300 [6.35 or 7.62]		1385638-3
2 @ 12	.130 Max. [3.30]	Tin	.300 [7.62]	1-1600960-8 (Standard)	1385637-3
2 @ 14	.137 Max. [3.48]	Tin	.300 [7.62]		1385637-3

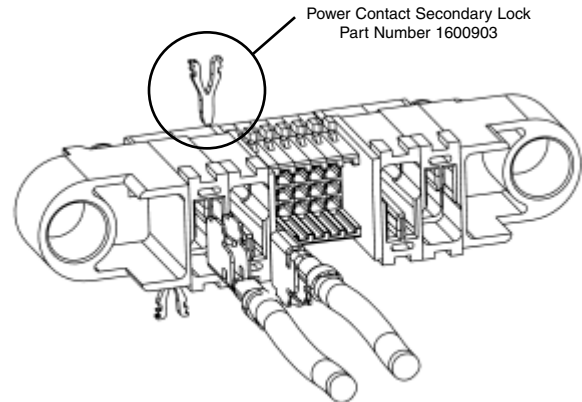
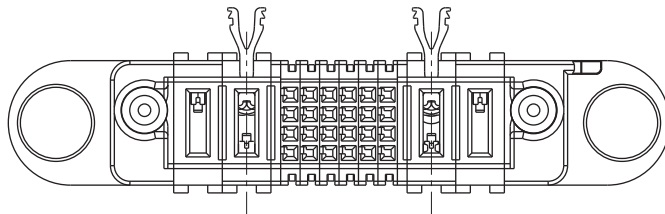

Power Contact Secondary Lock  
Part Number 1600903

**Secondary Power Locks:**  
Part Number 1600903-X

**Note:** One secondary lock needed for each power contact.

**Note:** All part numbers are RoHS compliant.

**MULTI-BEAM XL Power Distribution Connector System**  
**Cable Receptacle Assemblies** (Continued)

**Cable Receptacle Components** (Continued)

**Material and Finish**

**Contact** — Phosphor bronze plated gold over nickel in mating area

**Technical Documents**

**Product Specification**

108-25031

**Application Specification**

114-25021

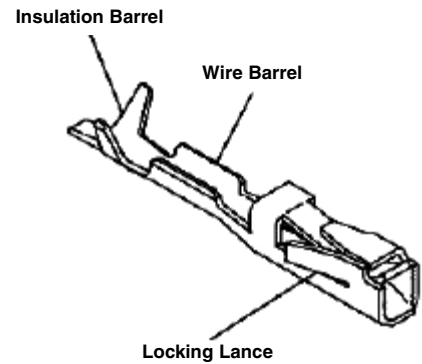
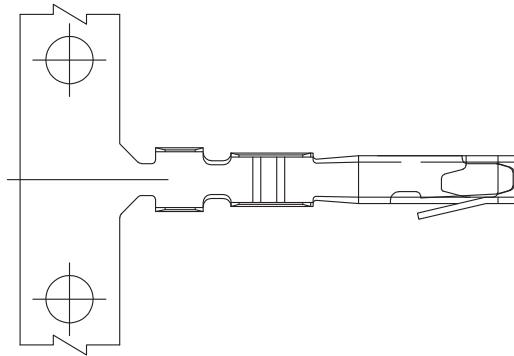

**Signal Contacts**

Wire Size Range AWG	Insulation Diameter	Version	Part Number	Extraction Tool
22-26	.036-.054 [0.91-1.37]	Low Pressure	531216-5 (reel)	91156-2
	.036-.054 [0.91-1.37]	High Pressure	531224-6 (reel)	91156-2

**Secondary Locks**

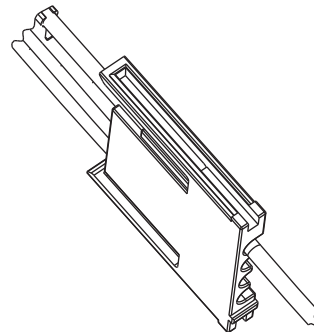
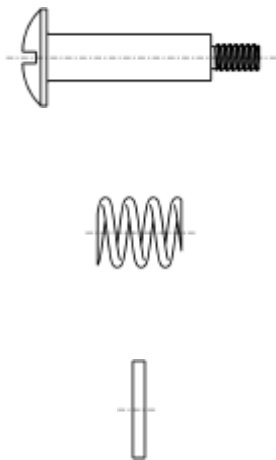

**Note:** One secondary lock needed for each column of signal contacts

**Secondary Signal Locks:**  
**Part Number 1600902-X**

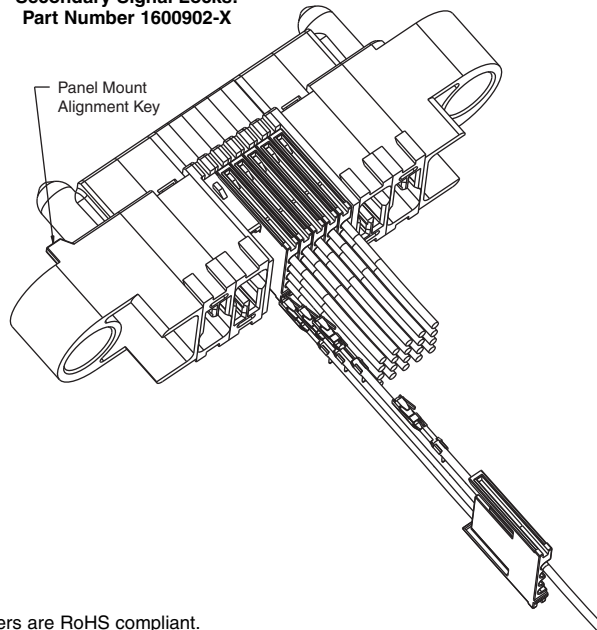

**Float Mount Hardware Kit**  
**Part Number 1600914-1**  
**(Standard Force)**  
**Part Number 1600914-3**  
**(High Force)**  
**1 Kit / Cable Assembly;**  
**Kit includes 2 screws, 2 washers**  
**and 2 springs**

**Note:** Kit not needed for STR or STL housings

**Note:** All part numbers are RoHS compliant.



**MULTI-BEAM XL Power Distribution Connector System**  
**Cable Receptacle Assemblies** (Continued)

**Specifications**

**Product Specifications**

**Power Contacts** —  
 50 Amps on single 8 AWG wire

**Signal Contacts** —  
 5 Amps on single 22 AWG wire  
 0.050" [1.27] minimum float in X,  
 Y and Z direction

**Sequenced Mating** —  
 3 Levels Pwr/Grnd, Pwr & Signal,  
 Signal 250 Cycle Durability

**Installed Connector Illustration**

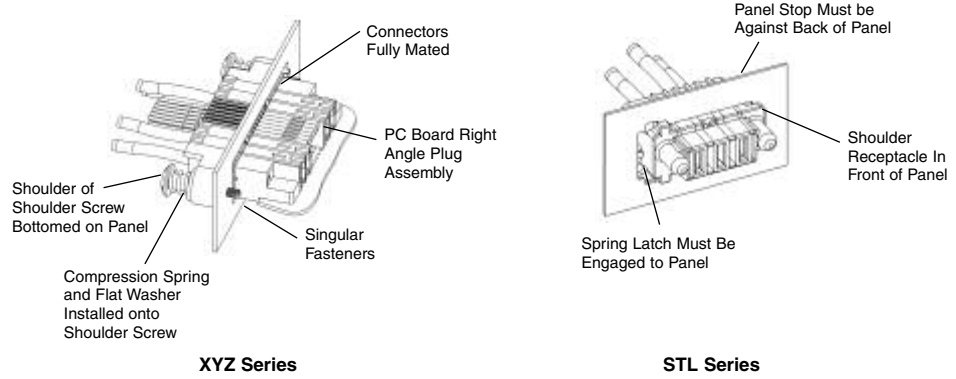

**XYZ Series**

**STL Series**

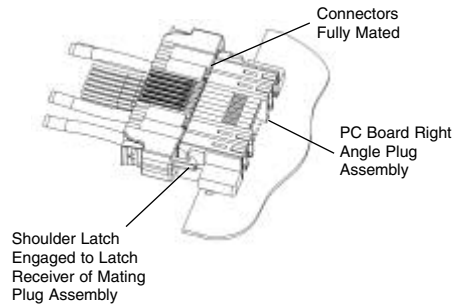

**STR Series**

Additional temperature-rise data available, contact Tyco Electronics Product Engineering.

Current/temperature rise data shown — from End-Of-Life qualification test.

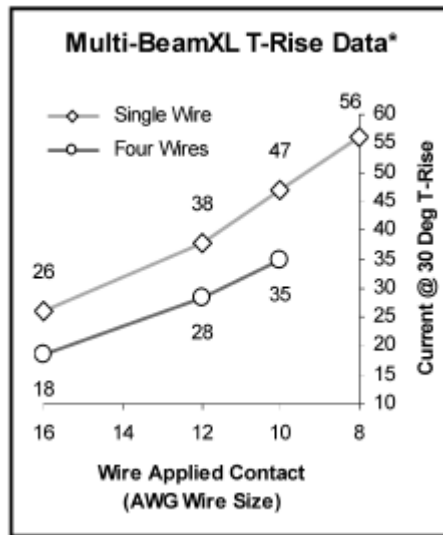

For more information see the product website @ <http://mbxl.tycoelectronics.com>

## “NEW” MULTI-BEAM XL Power Distribution Connector System Cable Plug Assemblies

### Cable Plug Assemblies

#### Product Facts

- High strength housing materials
- Hot-Pluggable
- Installation provides float in X, Y and Z directions
- Sequenced mating
- RoHS complaint
- Modular mold design provides configuration flexibility
- Integral cable clamp supports contacts and provides strain relief in minimum amount of space
- 30 microinch (0.76 micrometers) gold plated contacts for high reliability
- Sold only as part of a pre-assembled cable assembly



The newest addition to the MULTI-BEAM XL cable assemblies are the cable mounted plugs. Produced with modular molds, the connectors can be made in a wide variety of sizes. The pcb mounted MULTI-BEAM XL plugs are typically rigidly mounted to hot-swappable power supplies and the systems they connect with. The “float blind-mate drawer connector” design of the MULTI-BEAM XL cable connectors eliminates the concern of an inadequately aligned chassis. The connector can accept mating parts misaligned by as much as 3mm ( $\pm$  1.5mm), and still mate without

applying stress to solder or complaint pin terminations. The MULTI-BEAM cable plugs can terminate 8-14 AWG and 22-26 AWG wires all in one connector, without using adapter circuit boards. The use of high temperature glass filled housing materials, redundant contact retention and high conductivity contact materials allows the use of this connector in very high density applications.

The cable assemblies are all RoHS compliant designed to specific customer requirements and manufactured in Tyco Electronics’ internal cable assembly manufacturing facilities.

#### Technical Documents

**Product Specifications** — 108-2157-1

**Application Specifications** — 114-13164

#### For More Information

##### Internet

<http://tycoelectronics.com>

**Check out product information at:**

<http://mbxl.tycoelectronics.com>

**Technical Support Center**  
**1-800-522-6752**

**“NEW” MULTI-BEAM XL Power Distribution Connector System  
Cable Plug Assemblies (Continued)**

**Configurations/  
Part Numbers**

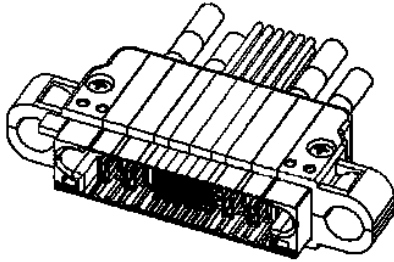

PMT

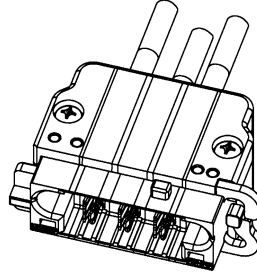

STL

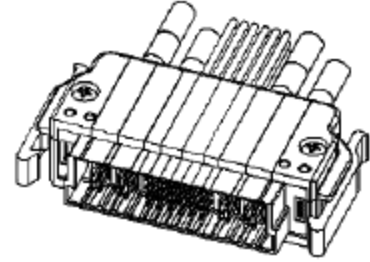

STR

**Power Module Widths:**

0.300" (ACP)  
0.250" (P)  
0.200" (HDP)

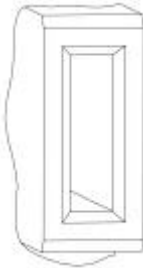

Module Designation	Maximum Wire Size		Max. Insulation Dia.
	AWG	mm <sup>2</sup>	
300 (ACP)	8	10.5	.272 6.91
250 (P)	10	6.6	.215 5.46
200 (HDP)	12	2.6	.156 3.96

**Signal Module Width:**

0.200" (8 Contacts)

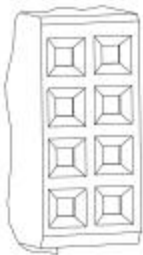

Module Designation	Maximum Wire Size		Max. Insulation Dia.
	AWG	mm <sup>2</sup>	
Signals	22-26	0.14-0.32	.036-.054 0.91-1.37

Configuration	PMT Series Plug	STL Series Plug	Mating Receptacles*		STR Series Plug	Mating Receptacles Vertical
			Vertical	Right Angle		
3 ACP	—	1761421-1	6450543-6	6450173-1	—	—
4 P	—	1761421-3	6450543-5	—	1600814-2	—
1P/16S/1P	1600236-5	1600820-2	—	2-6450170-0	1600238-4	6450740-4
1P/24S/1P	1600236-4	1600820-1	6450540-1	6450160-3	1600238-3	6450740-5
2P/24S/2P	1600236-6	1600820-3	—	2-6450170-1	1600238-5	6450740-6
3ACP/24S/3ACP	1600236-7	1600820-4	4-6450550-1	2-6450170-2	1600238-6	6450740-7

PMT Series — Panel Mount with total 3mm float in X,Y and Z directions  
 STL Series — Panel Mount with total 1.5mm float in X and Y directions  
 STR Series — Squeeze-to-Release for removeable Cable-to-Board / I/O Applications  
 \*Specifications on mating pcb mountable receptacles:  
 Product Specification — 108-2157-1  
 Application Specification — 114-13164

**Note:** All part numbers are RoHS compliant.

**“NEW” MULTI-BEAM XL Power Distribution Connector System  
Cable Plug Assemblies (Continued)**

**Connector Styles**

Intermateable with Tyco Electronics MULTI-BEAM XL pcb mounted receptacles

**Specifications**

**Wire Gauge** — 8 AWG – 14 AWG

**Sequenced Mating** — 3 Levels: Pwr/Gnd, Pwr & Signal, Signal

**Current Carrying Capacity** — Power Contacts — 45 Amps\* on single 8 AWG wire  
Signal Contacts — 4 Amps on single 22 AWG wire

**Durability** — 250 Cycle

**Temperature Range** — 40°C – 105°C

**Float** — 1.5mm float in X, Y, and Z Direction\*\*

**RoHS Compliant**

**UL, CSA, VDE Approvals Pending**

\*Based on End-of-Design Life Qualification Tests

\*\*Mated to Tyco Electronics MULTI-BEAM XL receptacles only

**PMT (Panel Mount) for True X, Y, Z Floating**

- Single-piece contact design — eliminates multiple contact interfaces
- Insulation crimp on all contacts
- Installation to panel provides float in X, Y and Z directions

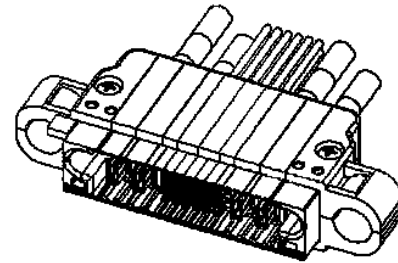

**STL (Slide-to-Lock) — Most Economical — Still Offering X and Y Floating**

- Single-piece contact design — eliminates multiple contact interfaces
- Insulation crimp on all contacts
- Installation to panel provides float in X and Y directions

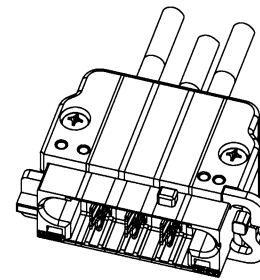

**STR (Squeeze-to-Release) — To Connect Sub-assemblies**

- Single-piece contact design — eliminates multiple contact interfaces
- Insulation crimp on all contacts
- Easy to mate/disconnect with squeeze-to-release latches

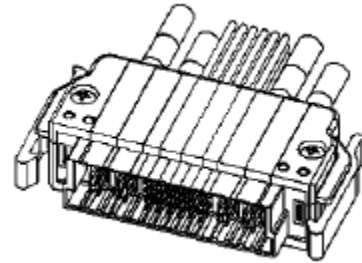

- Offered as pre-assembled, fully tested cable assemblies, as shown below
- Combines multiple power and signal connectors into a single Power I/O Connector

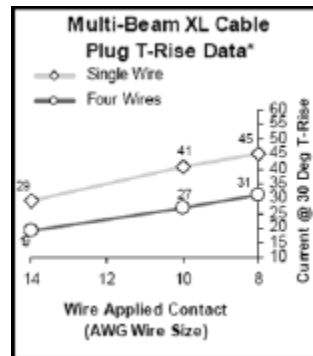
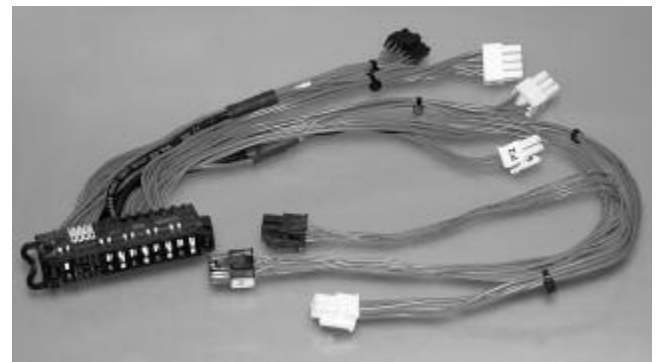

## MULTI-BEAM XL Connectors Custom Configuration Worksheet

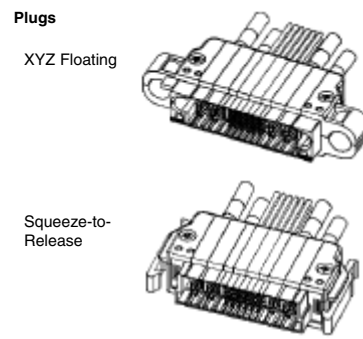
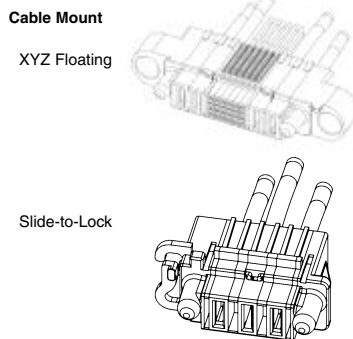
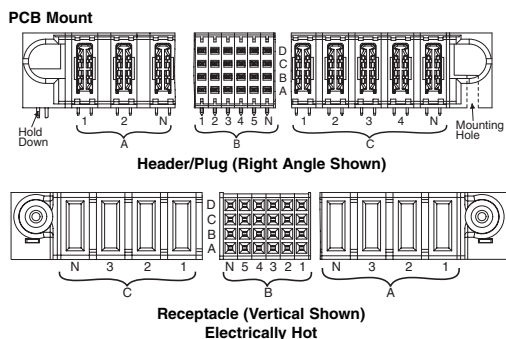

To create a unique configuration for MULTI-BEAM XL Connectors simply complete this worksheet and forward it to your Tyco Electronics sales engineer.

**1. Application**  Board-to-Board  Cable-to-Board

**2. Gender**  Plug (Male)  Receptacle (Female)

**3. Orientation**  
 Cable Only →  Blind Mate specify Floating or Slide-to-Lock receptacle  Latching  
 PCB Only →  Right Angle  Vertical

**4. Termination** (Cable Only)  
 Power  8 AWG  10 AWG  12 AWG  14 AWG  
 Signal  22 AWG  24 AWG  26 AWG

**5. Termination Style** (PCB Only)  Solder tail .135" [3.43mm]  Press-Fit .120" [3.05mm]  
 Solder tail .165" [4.19mm]  Press-Fit .135" [3.43mm]  
 Press-Fit .165" [4.19mm]

**6. Mounting to PCB**  Hold Downs (one on either end)  
 .122"[3.10mm] Mounting holes (Accepts #4 screws, right angle connectors only)  
 .150"[3.81mm] Mounting holes (Accepts #6 screws, right angle connectors only)

**7. Select # of Contacts**

**Section A: (Power Contacts)** \_\_\_ Enter # of Power Contacts (Loaded with standard length Power Contacts)  
 \_\_\_ Enter the position(s) to be loaded with Pre-mate contact (Receptacles only)  
 (Mate-First-Break-Last) ( i.e. #1, #3, etc.)

Contact Centerline Spacings:  .200"[5.08mm] (HDP)  
 .250"[6.35mm] (P)  
 .300"[7.62mm](ACP)

**Section B: (Signal Contacts)** \_\_\_ Enter # of Signal Contacts (Multiples of 8 are standard, i.e. 16, 24, 32...)  
 \_\_\_ Enter the Positions with Post-Mate Contacts (Mate-Last-Break-First, Plugs only)  
 Note: Row A is standard (i.e. A1, A3, etc.)

**Section C: (Power Contacts)** \_\_\_ Enter # of Power Contacts (Loaded with standard length Power Contacts)  
 \_\_\_ Enter the positions to be loaded with Pre-Mate Contacts (Receptacles only)  
 (Mate-First-Break-Last, i.e. #1, #3, etc.)

Contact Centerline Spacings:  .200"[5.08mm] (HDP)  
 .250"[6.35mm] (P)  
 .300"[7.62mm](ACP)

**8. Additional Requirements**

---



---

**9. Customer Information**

Name: \_\_\_\_\_ Company: \_\_\_\_\_ Location: \_\_\_\_\_

Phone: \_\_\_\_\_ Fax: \_\_\_\_\_ e-mail: \_\_\_\_\_

(Submit to your local Tyco Electronics Sales Engineer)



## MINIPAK High-Density Board-to-Board Power Connectors

### Product Facts

- High current per linear inch
- 32 Amps per contact, fully loaded
- Various configurations to meet requirements using less board space
- Built-in alignment feature
- Shrouded insulator design
- Meets safety regulatory requirements
- All MINIPAK products in this section are RoHS compliant

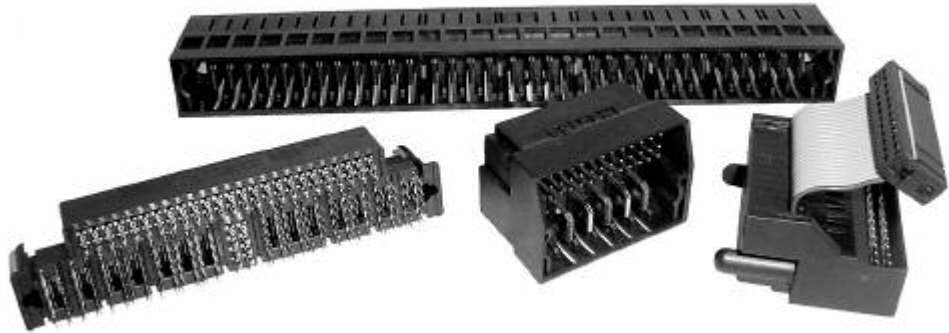

### Typical Applications

- Telecom and computer applications
- Routers
- Servers, mini and supercomputers
- Removable battery packs
- Uninterruptible power systems (UPS)
- Hot-swap N+1 power distribution

MINIPAK connectors are a family of board-to-board power connectors designed to deliver more current using less board real estate.

This goal is achieved by combining high density packaging with ELCON high-performance contact technology, including an innovative two-pole DualBlade contact that allows splitting 4.5 mm pitch contacts into multiple voltage rails.

### Product Highlights

#### High-Performance CROWN BAND Contact Technology

For the ultimate in current carrying capacity, MINIPAK connectors use ELCON CROWN BAND contacts individually rated at 43 Amps by Underwriter's Laboratory (UL), and mounted to the printed circuit board through 10 termination pins<sup>1</sup>.

#### Tight 4.5 mm Contact Pitch for Highest Current Density

MINIPAK connectors offer a combination of alignment guides, signal contacts, and power contacts on 4.5 mm, 6.0 mm, and 7.5 mm pitch to meet different output current and voltage requirements while using the least possible space on the board. The 4.5 mm pitch allows a very dense form factor ideal for space constrained power designs. The 7.5 mm pitch supports 250 VAC spacing requirements. Selective use of DualBlade contacts can further improve current density.

### Wide Selection of Configurations

MINIPAK connectors are available in numerous configurations. Which MINIPAK connector is most suited to your application will depend on requirements such as AC input current and voltage, DC output currents and voltages, number of signal contacts, board mounting style and available board space. Tyco Electronics will work with you to determine the best solution to your application, and can tool custom MINIPAK configurations if needed. A MINIPAK Connector Layout Form is available to help define your application requirements.

#### Note:

<sup>1</sup> Current rating will vary depending on contact layout, spacing, and thickness of copper on the board.

**MINIPAK High-Density Board-to-Board Power Connectors** (Continued)

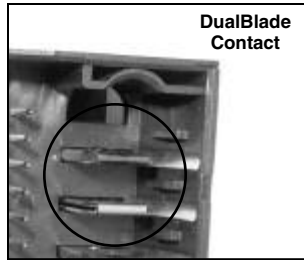

**DualBlade Contact**

**DualBlade Contact for More Density and Flexibility**

The DualBlade contact is a two-pole blade that allows splitting 4.5mm pitch contact blocks into multiple voltage rails that would otherwise be bussed together due their extreme proximity between contacts. Each side of the DualBlade contact can carry approximately 20A<sup>1</sup>.

<sup>1</sup> Current rating will vary depending on contact layout, quantity and spacing, and thickness of copper on the board

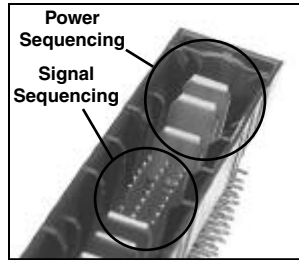

**Power and Signal Sequencing**

Sequencing of both power and signal contacts is available to allow use of MINIPAK connectors for hot-swapping of power supplies<sup>2</sup>. To specify your sequencing requirements, download the "MINIPAK Connector Configuration Form" on page 32.

<sup>2</sup> Not intended for current interruption.



**Eye of the Needle, Compliant Press-Fit Tails**

**Multiple Choices for Termination to the Board**

MINIPAK connectors can be mounted on the board or backplane using solder or press-fit tails<sup>3</sup>. Truly compliant eye of the needle press-fit tails are used to provide reliable solderless mounting.

Solder tails are available in two lengths to support boards of different thicknesses. See dimensions under CONNECTOR MOUNTING on next page.

<sup>3</sup> Press-fit tails available only on the socket side.

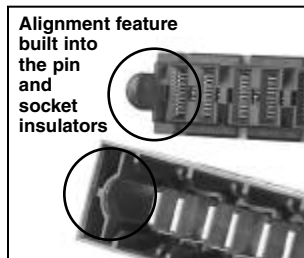

**Alignment feature built into the pin and socket insulators**

**Guides for Extra Alignment**

In addition to the blind mating capabilities built into the MINIPAK connector housing, a robust guide feature is available for designs that need improved gatherability due to the mechanical requirements of the design.



**Recessed Low Profile MINIPAK AC Socket Contacts**

**Fully Shrouded Housing and Probe-Proof Socket Contacts**

For full protection of the power contacts, MINIPAK pin housing connectors are fully shrouded and the socket contacts are recessed to be finger probe-proof. The AC socket contacts are further recessed into the socket cavity to offer compliance with UL 1950/IEC 950 safety requirements.

**MINIPAK High-Density Board-to-Board Power Connectors** (Continued)



Part Number	Right Angle PCB Plug				Mating Pair Overall Length	Vertical PCB Receptacle		
	No. 30A Pwr	No. 15A Pwr	Signal Contacts	Tails		Mating Part Number	Tails	Special Feature
6651672-2	3	2	6	Solder	1.38 35.00	6651673-1	Compliant Press-Fit	DualBlade
6651670-1	3	2	24	Solder	2.87 73.00	6651671-1	Compliant Press-Fit	DualBlade
6651742-1	8	12	58	Solder	3.78 96.00	6651743-1	Compliant Press-Fit	Stacked
6651668-1	21	0	24	Solder	5.71 145.00	6651669-1	Compliant Press-Fit	—
6651380-1	6	5	36	Solder	4.50 114.50	6651381-2	Compliant Press-Fit	DualBlade

\*The remaining power contacts are 30 Amps each

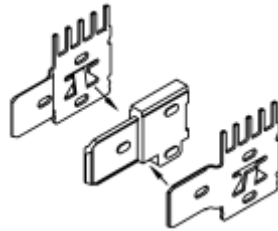

**DualBlade Contact**  
DualBlade Contact provides two 15 Amp contacts in the space of one 30 Amp contact



**DualBlade Contact Housing Assembly**

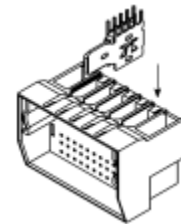

**Stacked MINIPAK Connector**

**Co-Planar Stacked MINIPAK**

Part Number	Right Angle PCB Plug				Mating Pair Overall Length	Right Angle PCB Receptacle		
	No. 30A Pwr	No. 15A Pwr	Signal Contacts	Tails		Mating Part Number	Tails	Special Feature
1766056-1	2	6	36	Solder	1.55 39.30	1766057-1	Solder	Stacked

**Custom MINIPAK Connector Configurations**

If the standard MINIPAK connector configuration does not meet your application requirements, Tyco Electronics may be able to tool a custom MINIPAK connector solution depending on your requirements and production volume. Please consult Customer Service for details.



**Note:** All part numbers are RoHS compliant.

**MINIPAK High-Density Board-to-Board Power Connectors** (Continued)

Board-to-Board Products

<b>Material</b>	
Insulators	PPA, UL 94V-0 flammability rated, color black
Socket contacts	Phosphor bronze alloy
Signal pins	Brass alloy
Power blades	Copper alloy
<b>Plating</b>	
Contacts	Selective 30 microinches gold over nickel
Terminals	Tin over nickel
<b>Environmental/Mechanical</b>	
Connector operating temperature range	-40°C to +130°C
Mating forces	Power: 1.5lb/contact typical Signal: 0.2lb/contact typical
<b>Electrical</b>	
Contact current rating	Individual power contact: 65A max. <sup>1</sup>
Voltage ratings	AC Power: 125/250VAC, signal & DC power: up to 60V
Insulation resistance	5000Ω at 500V DC for 2 minutes, per MIL-STD 1344, Method 3003
Dielectric strength	Power 1,500VAC, signal 250VAC; for 1 minute, per MIL-STD 1344, Method 3001

<sup>1</sup> This is the UL rating for an individual power contact. Current rating for any given configuration with multiple contacts will depend on contact layout, quantity and spacing.

**Contact Current Ratings**

The graph to the right shows the current carrying capabilities of an individual power contact, and that of multiple contacts at 4.5, 6.0 and 7.5mm contact spacing.

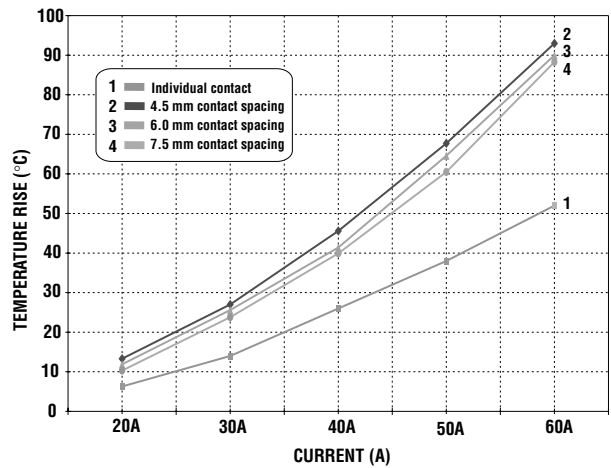

**Safety Regulatory Agency Compliance**

MINIPAK connectors have been evaluated and found to comply with the UL1977 standard and the CSA standard C22.2 No.182.3-M1987. Tyco Electronics will work with customers to obtain application-specific regulatory certifications if needed.



**Connector Mounting**

**Termination Tails**

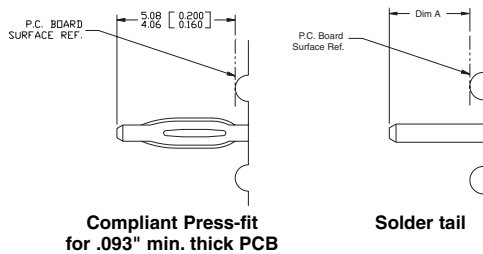

Dimension "A"	
Long Tail	Short Tail
.180 ± .020	.120 ± .020
4.57 ± 0.51	3.07 ± 0.51

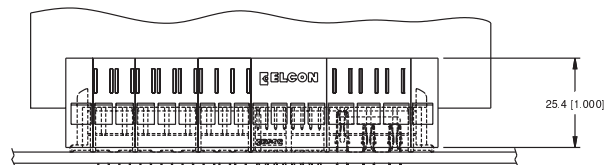
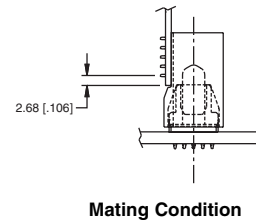

## “NEW” MINIPAK HD Connectors

### Product Facts

- Designed to the PICMG MicroTCA.0 Standard
- 30 microinches gold plating over nickel
- RoHS compliant
- 24 high current density power contacts, able to carry up to 14.5 Amps per contact when fully loaded
- Industry proven Universal Power Module (UPM) power contacts
- Hot-plug contact design controls arc during hot mate/unmate cycles
- 3 mating levels



Tyco Electronics supplies the Power Entry Module (PEM) connector specified in the PICMG MicroTCA Standard. The PICMG MicroTCA.0 Standard is one of the latest standards addressing future telecommunications needs. The MINIPAK HD combines 24 power contacts and 72 high density signal contacts. The power contacts are the industry proven contacts

utilized in the Universal Power Module (UPM) and are capable of carrying 14.5 Amps per contact when fully energized. Rugged contact design ensures long-term reliability and sacrificed contact tip, controls arcing during hot mate/unmate cycles. The MINIPAK HD also features 3 levels of mating and selective gold plating on contacts.

### Contact Blades Product Facts

- Designed for HOT Swap applications
- Extended sacrificial contact tip absorbs arc
- Main contacts stay free of contaminants



MINIPAK HD Contact Blades

### Technical Documents

**Product Specification** —  
108-2253

**Industry Standard** —  
PICMG MicroTCA R1.0

MicroTCA and PICMG are trademarks of PICMG-PCI Industrial Computer Manufacturers Group, Inc.



**“NEW” MINIPAK HD Connectors** (Continued)

Board-to-Board Products

**MicroTCA Connectors —  
MINIPAK HD Board-to-  
Board Connector**

**Vertical Receptacle,  
Compliant Press-Fit**

**Part Number 1469920-1  
(tin-lead pcb tails)**

**Part Number 1469920-2  
(tin plated pcb tails)**

The vertical connector consists of 72 2 mm pin and 24 Universal Power Module (UPM) receptacle contacts. The contacts have compliant pin tails for press-fit applications.

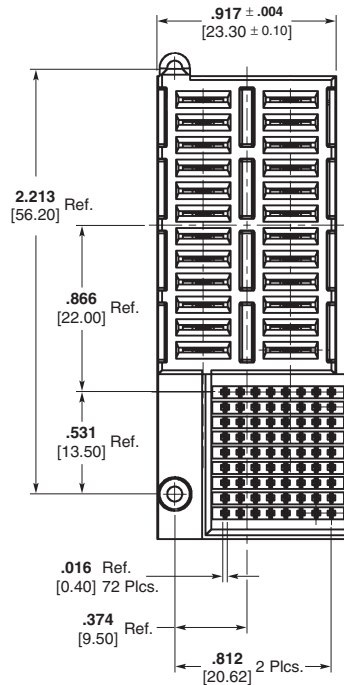

**Part Number 1469920-1**

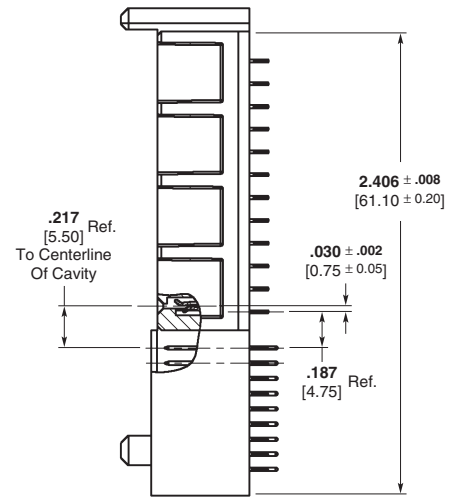

**Right Angle Plug, Solder  
Tail or Compliant Press-Fit**

**Part Number 1469921-1  
(Solder Tail)**

**Part Number 1469922-1  
(Press-Fit)**

**Part Number 1469922-2  
(Press-Fit, Tin-Lead PCB  
Tails)**

The right angle connector consists of 72 high density signal pins and 24 right angle UPM blades that feature 2 mating lengths for the mate first/break last ground sequencing. The right angle connectors come in 2 piece tail variations, press-fit and solder.

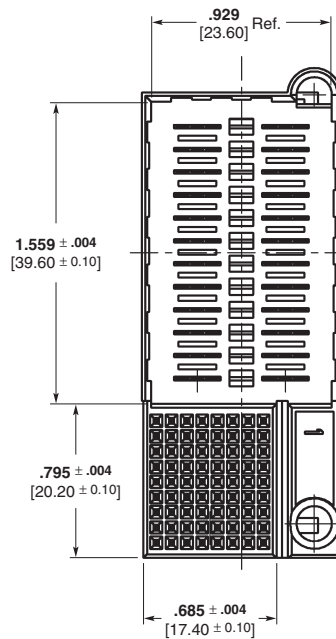

**Part Number 1469921-1**

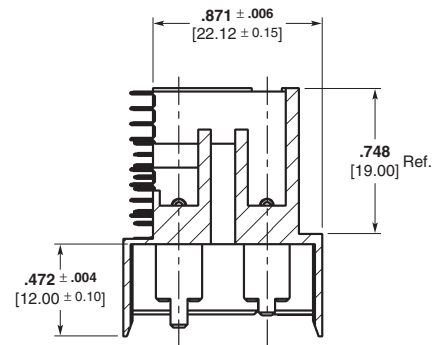

**Note:** All part numbers are RoHS compliant.

## “NEW” MINIPAK HDE Connectors

### Product Facts

- Compatible with 2mm equipment practices per IEC 61076-4-101
- One-piece molded housing — fewer parts to assemble to pcb
- Very high current density — 18 Amps per contact on each contact in an 8-position (2 x 4) connector
- 4 pcb tails distributes the current with just 4.5 amps per plated through hole
- Hot-pluggable contact design reduces contact degradation associated with live pcb insertions / extractions
- Two-levels of contact sequencing for mate-first-break-last operation

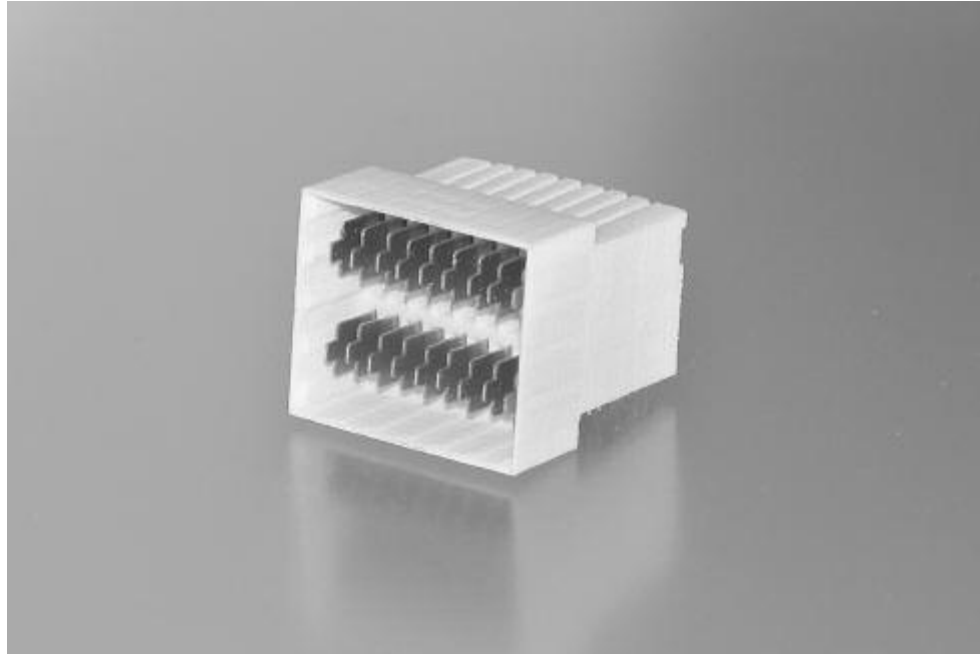

### Technical Documents Product Specification 108-2289

The latest high current power module is designed to serve in both backplane power distribution and general pcb-to-pcb applications is the new MINIPAK HDE connector. It was designed to compliment the most popular high-speed backplane connectors offered by Tyco Electronics, including HM-Zd, Z-PACK TinMan and MULTIGIG RT connectors.

The two-row configuration offers a benefit to the pcb designer. The power can be fed from either the top or bottom row, with the return path routed through the other remaining row. Alternatively, the same voltage rail can be routed to

both the top and bottom rows and the return path can be routed to both the top and bottom rows of adjacent contacts.

The two row configuration offers the additional benefit of occupying just half the linear pcb edge space of other types of board-to-board power modules.

The low mating force contact reduces the moment / stresses on the connector during mating and reduces the plating wear for long-term reliability.

The MINIPAK HDE connector has two-levels of blade lengths to provide mate-first-break-last operation for hot swap operation.

In addition, in the event the connector is used to mate or un-mate to a live load, the sacrificial contact tip absorbs the arc to keep the remaining contact mating surfaces free of damage. This “hot-plug” contact design has been approved by UL for current interrupt applications.

All MINIPAK HDE connectors are easily applied to the pcb with common “flat-rock” seating tools. The connector mates with Tyco Electronics’ Universal Power Module connectors found on page 52.

**“NEW” MINIPAK HDE Connectors (Continued)**

**Contacts**

Industry proven Universal Power Module (UPM) style contacts

**Performance Data**

**Current Rating** — 18 Amps on each contact in the 8-position (2x4) connector

**Low Level Contact Resistance** — 2 milli-ohms max

**Operating Temperature** — -40°C to +105°C

**Technical Documents**

**Product Specification**  
108-2289

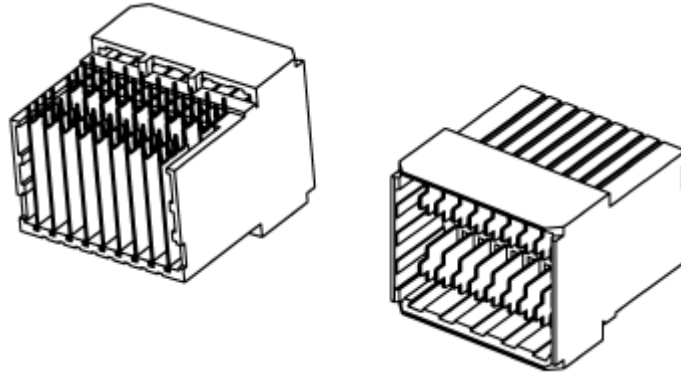

Description	Part Number	Dimension L	Mating Connector*
2 x 3	1926223-1	.472" [12.00]	5-5223955-2
2 x 4	1926224-1	.590" [15.00]	120953-1
2 x 5	1926225-1	.708" [18.00]	120953-2
2 x 6	1926226-1	.826" [21.00]	120953-3
2 x 7	1926227-1	.944" [24.00]	120953-4
2 x 8	1926228-1	1.06" [27.00]	120953-5
2 x 9	1926229-1	1.18" [30.00]	120953-6

\*Mating connectors are single row, MINIPAK HDE requires 2 x mating connectors

**Note:** For more information on the mating connector please see page 50.

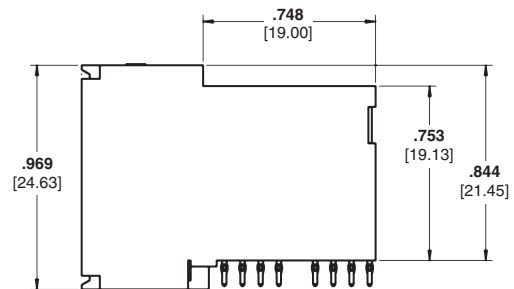
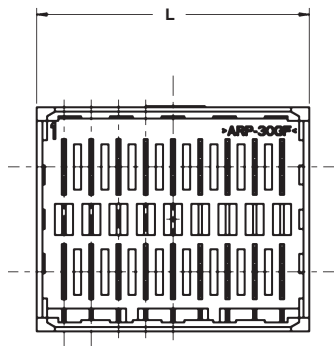

**Note:** All part numbers are RoHS compliant.

## FLATPAQ Modular Board-to-Board Power Connectors

### Product Facts

- 32 Amp high-performance ELCON CROWN BAND power contacts
- True hot-plug power contacts available for current interruption under load
- Versatile modular design allows customized configuration to meet your specific application requirements
- Perpendicular, parallel and co-planar styles available
- Sequenced mating of power and signal contacts
- Solder and compliant press-fit termination to the board
- Unique active guide modules double as alignment guide and power contact
- All FLATPAQ Products in this section are RoHS compliant

### Typical Applications

- Board-to-board power interconnections
- Hot-swap N+1 power distribution for telecommunications, servers and mini-computers
- Uninterruptible power systems (UPS)
- Removable battery packs

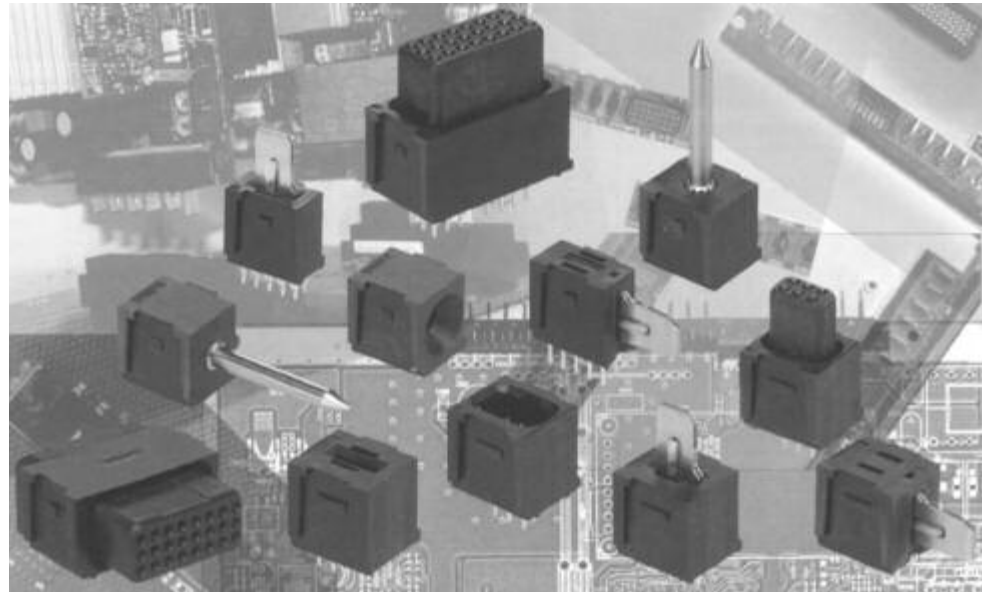

FLATPAQ connectors provide hot-pluggable AC and DC power in board-to-board applications. Customized configurations of up to 45A power contacts, signal & logic lines, and guides (both active and passive) are enabled by the assembly of various standard modules. This allows the designer to specify guidance for blind mating situations, contact mating sequence, spacing for voltage ratings, and current interruption under load (true Hot-Plug), to meet custom design requirements without incurring any tooling expense.

### Product Highlights Highly Configurable

FLATPAQ connectors are custom configurable using standard modules that can be arranged in any order to meet the application requirements. It is even possible to have both power blades and power sockets in the same connector side. Using off-the-shelf, modular components enables quick turnaround of sample requests, typically within one week, to allow your design to move forward on schedule.

### High-performance ELCON Power Contacts

FLATPAQ socket modules use proven CROWN BAND technology, for low insertion and extraction forces, minimal voltage drop and reduced temperature rise. The latest generation contacts are 45A USR rated (32.5A CNR) and can handle even higher currents when mounted on boards with 5 oz copper traces or on bus bars.

Hot-Pluggable socket contacts are rated at 35A USR, 20A CNR. Both Hot-Plug and regular sockets can be mixed in the same connector (as can both power blades and power sockets).

Standard power modules utilize the same contacts as the MINIPAK Connectors for cost effectiveness. The original "float" mounted blade modules are still available where physically isolating the blade from the PCB solder joints is desired.

24-position straight mount Signal socket modules are now available in a cost effective 1A design.

### Power and Signal Sequencing

Power contacts are available in Standard, Premate and Postmate lengths to meet your power sequencing requirements. Signal contacts have Standard and Premate length options, consult Customer Service for details.

**FLATPAQ Modular Board-to-Board Power Connectors** (Continued)

**Various Contact Termination Styles**

All connectors are available in two lengths of solder termination, .115" (2.9 mm) nominal for 0.062" (1.6 mm) thick boards, and 0.177" (4.5 mm) for 0.093" (2.4 mm) and 0.125" (3.18 mm) boards.

Straight mount socket connectors are also available with compliant 'Eye of the Needle' design press-fit terminals for 0.093" (2.4 mm) minimum thickness boards and bus

bars. Tyco Electronics will provide details of the recommended pressing fixture for each assembly.

All terminations fit 0.040 +/- .0030" (1.02 +/- .08 mm) diameter plated through holes.

**Alignment Guides and Mounting Ears**

FLATPAQ Connector alignment guides improve gatherability in blind mate situations and can be either electrically active (35A rated) or passive. Passive

guides should be used in conjunction with mounting ears when placed at the end of the connector. Mounting ears should also be considered on right angle mounted connectors.

**Finished Connector Drawing**

Tyco Electronics will provide a Customer Drawing showing all envelope dimensions and PCB mounting pattern based on the configuration indicated using the layout sheet available at [www.tycoelectronics.com](http://www.tycoelectronics.com).

See page 41 for details on completing the layout sheet. A drawing with general contact sequencing and alignment information is available; please contact Customer Service for a copy.

**Safety Regulatory Agency Compliance**

FLATPAQ connector has been evaluated by safety regulatory agencies for use in data, signal, control and power applications. Consult Customer Service for details.

**Electrical Performance**

The graphs below show the performance of the FLATPAQ contact design in terms of temperature rise against current. Tests were performed on 250 V power modules mounted on PC boards with 2 oz, 3 oz, and 5 oz copper traces.

**Temperature Rise**

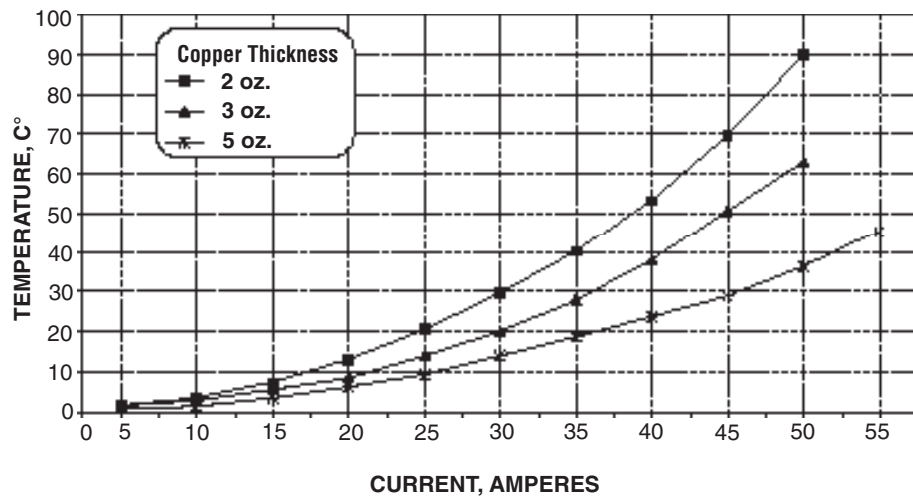

**Voltage Drop**

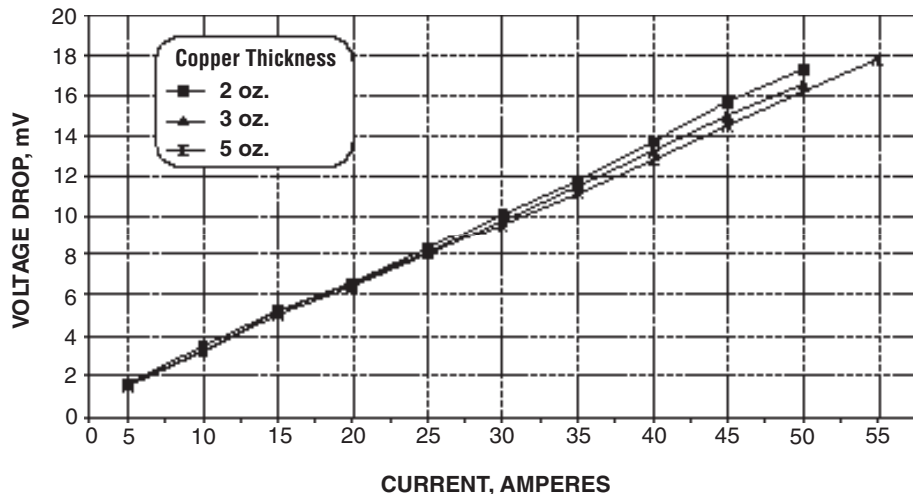

## FLATPAQ Connector Product Specifications



### Materials

Insulators	PPA, UL 94V-0 flammability rated, color black
Power Blades	Copper alloy
Power Sockets	Phosphor Bronze
Hot-Plug Power Sockets & Active Guide Sockets	Crown Bands: Beryllium Copper Holder: Phosphor Bronze
Signal Pin Contacts	Solder termination: Brass Press-fit: Phosphor Bronze
Signal Socket Contacts	1 Amp: Phosphor Bronze 3 Amp: Beryllium Copper
Passive Guide Pin	Brass
Active Guide Pin	Copper alloy

### Finishes

Contacts	Selectively plated gold (30 microinches minimum) with tin on terminations, all over nickel
Passive Guide Pin	Nickel
Active Guide Pin	Silver

### Electrical

Current Rating	UL	45 Amp
Power Contacts	CUR/CSA	32.5 Amp
Current Rating, Hot-Plug Power Contacts	UL	35 Amp at 250V, 50 cycles
Hot-Plug Power Contacts	CUR/CSA	20 Amp at 250V, 50 cycles
Signal Contacts, 1 Amp	UL	1 Amp, 250 VAC
	CUR/CSA	1 Amp, 250 VAC
Signal Contacts, 3 Amp	UL	3 Amp, 250 VAC
	CUR/CSA	2.5 Amp, 250 VAC
Contact resistance	Power	2 mΩ maximum initial, (3 mΩ maximum after 500 cycles durability), at 35A per MIL-STD-1344, Method 3004
	Signal	15 mΩ maximum initial, (30 mΩ maximum after 500 cycles durability), at 100mA, 20 mV, per MIL-STD-1344, Method 3002
Insulation Resistance		5,000 MΩ minimum at 500VDC for 2 minutes, per MIL-STD-1344, Method 3003
Dielectric Strength		1,500 VDC for 1 minute, per MIL-STD-1344, Method 3001

### Mechanical

Insertion Force	Power Signal	4.0 lbf (17.8 N) maximum 5.0 ozf (1.4 N) maximum, using .0305" (.775mm) diameter steel test pin
Extraction Force	Power Signal	1.0 lbf (4.4 N) minimum 0.5 ozf (0.1 N) minimum, using .0295" (.749mm) diameter steel test pin
Contact Retention (in insulator)	Power Signal	10.0 lbf (44.4 N) minimum 5.0 lbf (22.2 N) minimum
Durability		500 Cycles, per MIL-STD-1344, Method 2016
Operating Temperature		-40 to +105° C
Recommended PCB Hole		Finished hole: 0.040 +/- .0030" dia. (1.02 +/- .08 mm dia.) Drilled hole: 0.0453 +/- .0005" dia. (1.15 +/- .013 mm dia.) Copper Plate: 0.0010" (.025 mm) min. per surface Tin Plate: 0.0003" (.008 mm) min. per surface
Press-Fit Tooling		Press fixture is recommended for compliant press-fit assemblies. Consult Tyco Electronics for tool drawing
Marking		Connectors are marked with manufacturer's logo, part number and lot code



**FLATPAQ Connectors**

**Part Number 6646465-1**  
**FLATPAQ 250V Straight**  
**Socket Connector**  
**4 Power, 24 Signal**  
**Contacts**

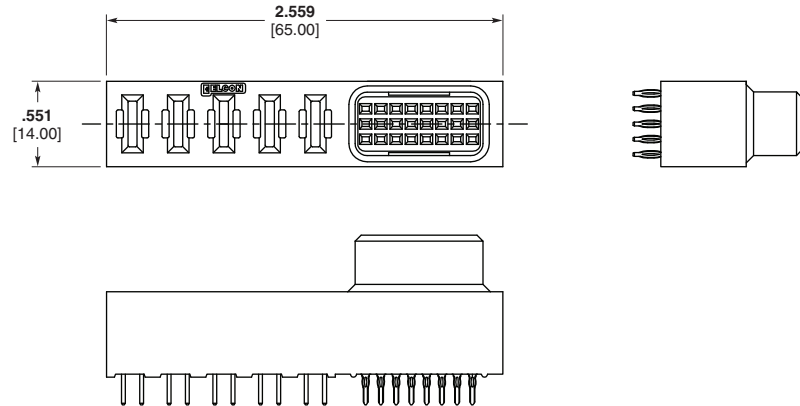

**Part Number 6646871-1**  
**FLATPAQ 250V/600V**  
**Right Angle Pin Connector**  
**6 (250V) Power,**  
**1 (600V) Power**

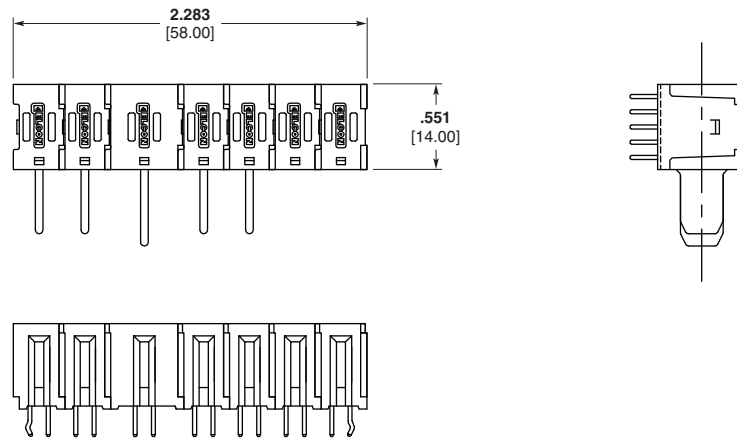

**Part Number 6646770-1**  
**FLATPAQ Right Angle**  
**Pin Connector**  
**8 Power, 24 Signal**  
**Contacts**

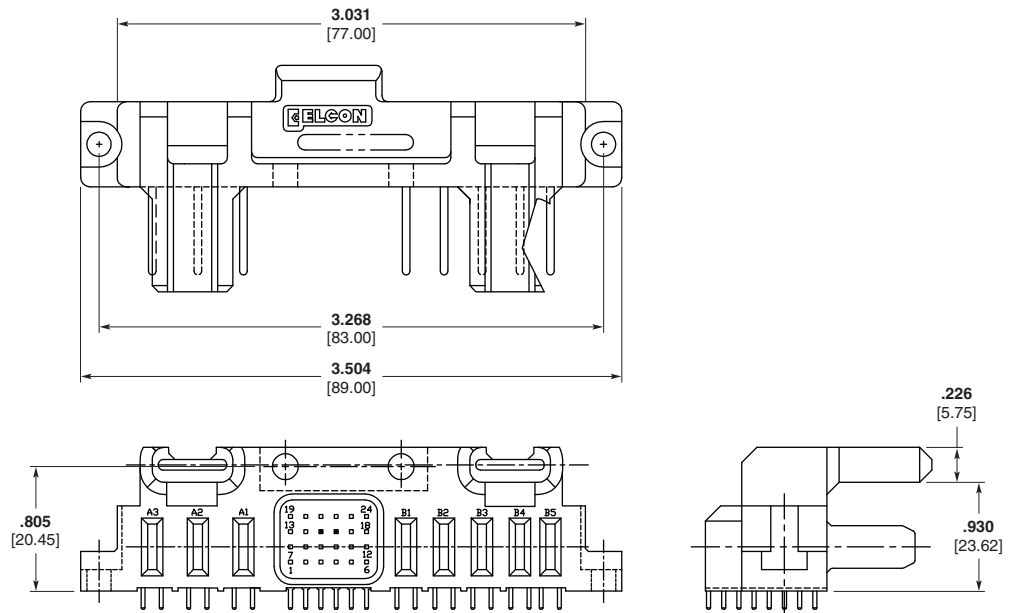

**Note:** All part numbers are RoHS compliant.

## How to Specify Your Modular FLATPAQ Connector

We will generate a Customer Drawing for you to check and approve prior to connector production. Samples are also available upon request.

- 1** Enter your contact information, including signature and date.
- 2** Indicate the connector layout by filling in the FP number of each module required in the boxes, one per box. Use one form per mated pair. The left to right order of the modules should match the mating face views of the connector. When laying out right angle assemblies, make sure that you look at the termination tails facing downwards.
- 3** For solder terminated assemblies, indicate the tail length for each half of the connector using the checkboxes to the right of the layout grid.

### Sample Modular FLATPAQ Connector Layout Form

#### Instructions

1. Indicate the connector layout by filling in the FP number of each module required in the boxes, one per box. Use one form per mated pair.
2. The left to right order of the modules should match the **mating face views** of the connector. **When laying out right angle assemblies**, make sure you look at the mating face with the termination tails facing downwards.
3. For **solder terminated assemblies**, indicate the tail length for each half of the connector using the checkboxes to the right of the layout grid.
4. Sign, date and send the completed form to your local Tyco Electronics Sales Engineer.

**Upon receipt of this form, Tyco Electronics will generate a Customer Drawing for you to check and approve prior to connector production.**

Write the "FP" numbers to indicate the layout of one half of the connector assembly, matching the left to right order with the mating face view of the connector (right angle assembly tails facing downwards).

FP	FP	FP	FP	FP	FP	FP	FP	FP	FP	FP	FP	FP	FP	FP	FP	<b>Solder Tail Options</b> <input type="checkbox"/> .115" (2.9 mm); .062" thick boards <input type="checkbox"/> .177" (4.5 mm); .093/.125" boards
----	----	----	----	----	----	----	----	----	----	----	----	----	----	----	----	---

Write the "FP" numbers to indicate the layout of the mate of the above assembly, matching the left to right order with the mating face view of the connector (right angle assembly tails facing downwards).

FP	FP	FP	FP	FP	FP	FP	FP	FP	FP	FP	FP	FP	FP	FP	FP	<b>Solder Tail Options</b> <input type="checkbox"/> .115" (2.9 mm); .062" thick boards <input type="checkbox"/> .177" (4.5 mm); .093/.125" boards
----	----	----	----	----	----	----	----	----	----	----	----	----	----	----	----	---

ENTER CUSTOMER INFORMATION	
Company	Location
Contact Name	Title
Telephone	Fax
Email Address	
I am: <input type="checkbox"/> End user <input type="checkbox"/> Contract manufacturer (end user: _____)	
Signature	Today's Date
Annual Quantity Required	

Submit to your local Tyco Electronics Sales Engineer.

#### Right Angle Mount

**250 V Power Modules**

FP151  
Standard Blade  
Float, Standard

FP152  
Premate Blade  
Float, Premate

FP153  
Postmate Blade  
Float, Postmate

FP104  
Hot-Plug Socket

FP512  
Spacer, 250 V

**Signal Modules**

FP302  
24-Pin

FP303  
24-Pin Socket

FP314  
6-Pin

FP315  
6-Pin Socket

**600 V Power Modules**

FP155  
Standard Blade  
Float, Standard

FP156  
Premate Blade  
Float, Premate

FP157  
Postmate Blade  
Float, Postmate

FP120  
Hot-Plug Socket

FP514  
Spacer, 600 V

**Mounts**

FP500  
Left Flange Mount

FP501  
Right Flange Mount

**Guides**

FP506  
Passive Guide Pin

FP507  
Right Angle Passive Guide Pin

#### Straight Mount

**250 V Power Modules**

FP150  
Socket, Solder  
Hot-Plug, Solder

FP250  
Socket, Press-fit  
Hot-Plug, Press-fit

FP161  
Standard Blade  
Float, Standard

FP101  
Float, Standard

FP162  
Premate Blade  
Float, Premate

FP102  
Float, Premate

FP163  
Postmate Blade  
Float, Postmate

FP103  
Float, Postmate

FP511  
Spacer, 250 V

**Signal Modules**

FP300  
24-Pin, Press-fit

FP400  
24-Pin Skt, Press-fit

FP318  
24-Pin Socket

FP418  
24-Pin Skt, Press-fit

FP312  
6-Pin

FP412  
6-Pin, Press-fit

FP313  
6-Pin Socket, 3A Rated

FP413  
6-Pin Skt, 3A, Press-fit

**Note:** All modules are solder tail termination unless indicated as compliant Press-fit. Select solder tail length using checkboxes to the right of the connector layout grid above. 0.093" or thicker boards are recommended for compliant Press-fit termination style. Consult Tyco Electronics for signal module sequencing. See Catalog 1773096 for benefits of Hot-Plug and Float options.

**600 V Power Modules**

FP154  
Socket, Solder  
Hot-Plug, Solder

FP254  
Socket, Press-fit  
Hot-Plug, Press-fit

FP165  
Standard Blade  
Float, Standard

FP117  
Float, Standard

FP166  
Premate Blade  
Float, Premate

FP118  
Float, Premate

FP167  
Postmate Blade  
Float, Postmate

FP119  
Float, Postmate

FP513  
Spacer, 600 V

**Mounts**

FP500  
Left Flange Mount

FP501  
Right Flange Mount

**Guides**

FP502  
Straight Passive Guide Socket

FP503  
Passive Guide Pin

FP515  
Active, M3 Guide Socket

FP517  
Active, 4-40 Guide Pin

### How to Obtain Modular FLATPAQ Connector Layout Forms

Modular FLATPAQ Connector layout forms can be obtained directly from Customer Service or through your Tyco Electronics Sales Engineer. They can also be downloaded from the website; at <http://www.tycoelectronics.com>.

**ICCON Single Pole Power Connectors**

**Product Facts**

- Uses high-performance Crown contact
- 35A current rating
- True compliant press-fit and solder tails
- Pin locking feature option
- Standard DIP footprint .300 x .100 and ICCON SLIMLINE Connector .100 x .100
- Insulator rated at 105°C, UL 94V-0
- Meets safety regulatory requirements
- #8 AWG wire size
- Parallel and perpendicular
- Sequencing capability
- All ICCON Products in this section are RoHS compliant

**Typical Applications**

- Power distribution
- Board-to-board interconnection
- Board-to-busbar interconnection
- Board-to-wire interconnection
- High-density power designs
- Board stacking

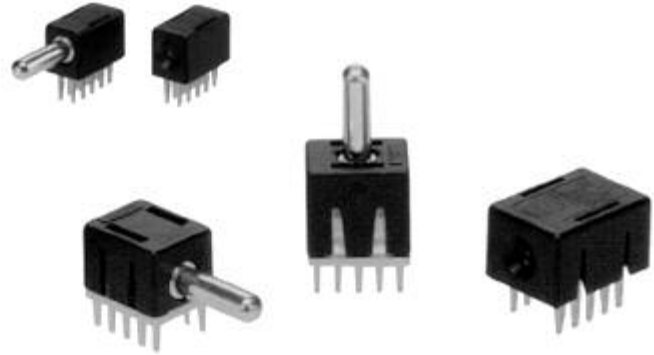
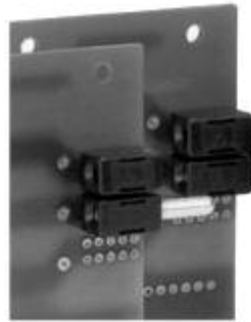

ICCON connectors provide a reliable high current power interconnection with quick connect/disconnect function for space constrained motherboard-daughterboard, cable-board and board-busbar power delivery applications.



**Product Highlights**

**High Performance Contact**

ICCON connectors use ELCON CROWN BAND Contact, a multifingered spring which provides a greater surface contact area, thus ensuring small millivolt drop, minimum heat generation and very low insertion and extraction forces.

**Optional Locking Feature**

The optional locking feature provides minimum 5 lbs. (2.21kg) retention force to improve connection integrity, securing against accidental unmating in harsh mechanical conditions.

**Support for Multiple Mounting Styles**

ICCON connectors are available with press-fit or solder tails for mounting on both PC boards and bus bars. Tyco Electronics uses eye of the needle true compliant tails for the most reliable mounting using solderless techniques.

Each ICCON connector has a 10 pin DIP footprint for convenient industry standard mounting. Through hole socket connectors can be used in "bottom entry" applications.

**Mating with Discrete Contracts**

For further versatility, ICCON connector products can mate with discrete contacts, available in a variety of termination types.

**ICCON SLIMLINE Connectors**

With a footprint close to 30% smaller than the standard ICCON connector products, the ICCON SLIMLINE connector products allow integrating more components in less board real estate, providing substantial space savings compared to connectors of this type in the same performance range.

**ICCON Standard DIP Connectors (.300 x .100 footprint)**

**Right Angle Receptacle**

Part Number 6643232-1 Solder  
Part Number 6643272-1 Compliant

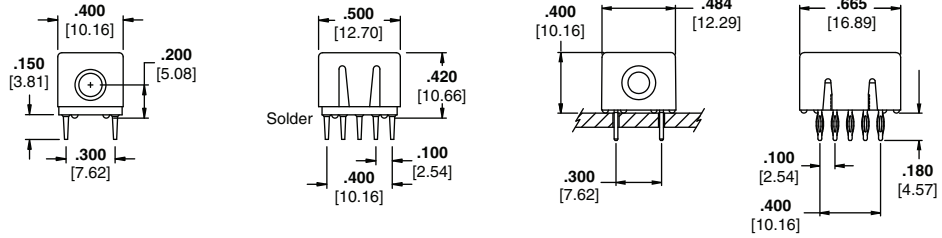

**Right Angle Pin**

For Part Numbers and "A" Dimension  
See Table Below

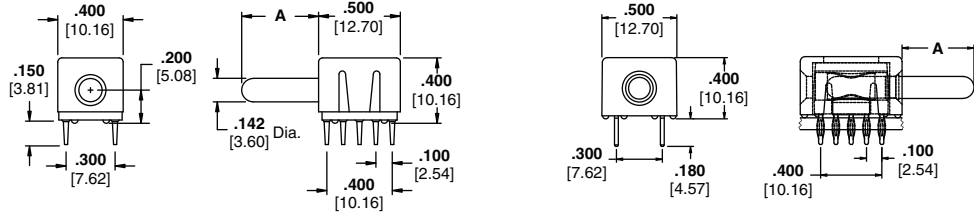

**Vertical Receptacle**

Part Number 6643264-1 Through Hole, Solder  
Part Number 6643247-1 Closed, Solder  
Part Number 6643269-1 Through Hole, Compliant

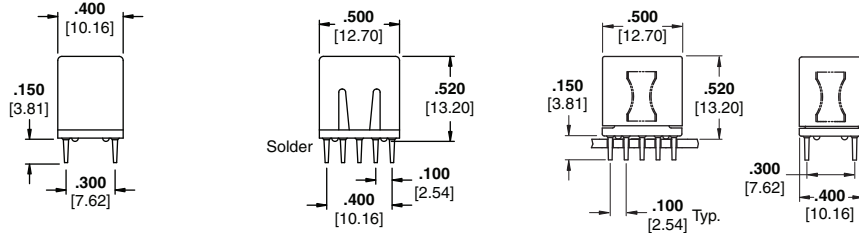

**Vertical Pin**

For Part Numbers and "A" Dimension  
See Table Below

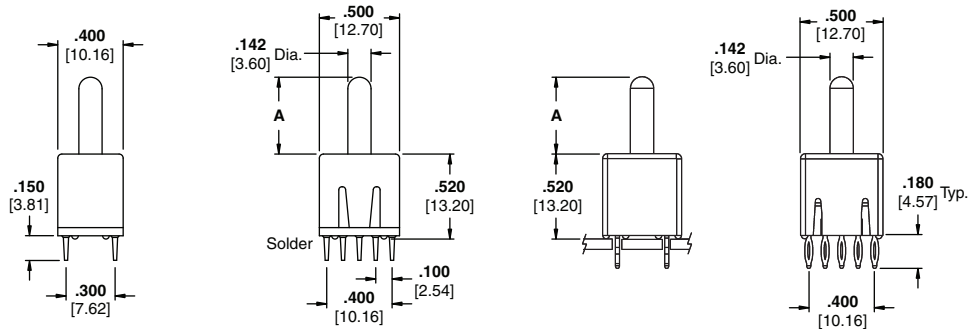

Right Angle Pins Solder Tail	Compliant	Locking Style	Length "A"
6643281-1	6643275-1	Non-Lock	.470 [11.93]
6643276-1	6643273-1	Lock	.470 [11.93]
6643431-1	6643442-1	Non-Lock	.570 [14.48]
6643432-1	6643443-1	Non-Lock	.750 [19.05]
6643433-1	6643444-1	Non-Lock	1.000 [25.40]
6643434-1	6643445-1	Non-Lock	1.250 [31.75]
6650785-1	6643446-1	Non-Lock	1.500 [38.10]
6643435-1	6643447-1	Non-Lock	1.750 [44.45]

Vertical Pins Solder Tail	Compliant	Locking Style	Length "A"
6643283-1	6643274-1	Non-Lock	.470 [11.93]
6643266-1	6643271-1	Lock	.470 [11.93]
6643436-1	6643449-1	Non-Lock	.570 [14.48]
6643437-1	6643450-1	Non-Lock	.750 [19.05]
6643438-1	6643451-1	Non-Lock	1.000 [25.40]
6643439-1	6766439-1	Non-Lock	1.250 [31.75]
6643440-1	6766440-1	Non-Lock	1.500 [38.10]
6643441-1	6766441-1	Non-Lock	1.750 [44.45]

**Note:** All part numbers are RoHS compliant.

**ICCON Discrete Contacts**

**Crimp Socket**

Part Number 6648317-1 #8 AWG

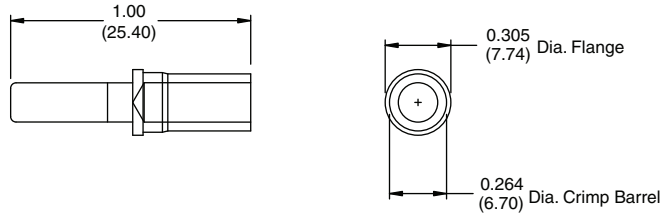

**Crimp Pins**

Part Number 1766163-1  
#8 AWG Non-Lock  
Part Number 1766160-1  
#8 AWG Lock  
Part Number 1766816-1  
#10 AWG Non-Lock  
Part Number 1766161-1  
#10 AWG Lock

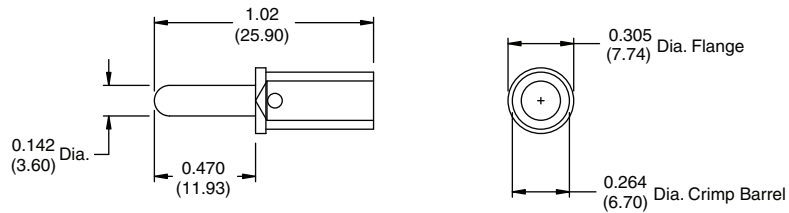

**Board Mount Pin — Floating**

Part Number 6643252-1  
"A" = 1.250 (31.75)  
Part Number 6643253-1  
"A" = 1.350 (34.29)

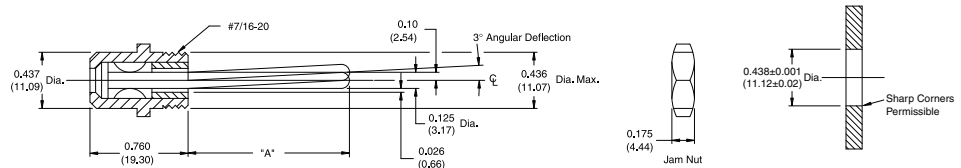

**Mounting Requirements**

**Mounted Example:**

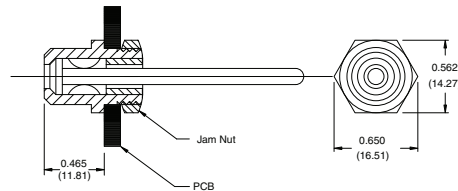

**Board Mount Pin**

Part Number 1766815-1  
"A" = 1.250 (31.75)  
Part Number 1766157-1  
"A" = 1.350 (34.29)

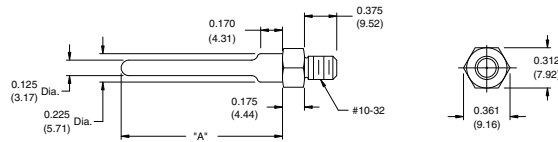

**Double-Ended Board Mount Pin**

Part Number 1766817-1

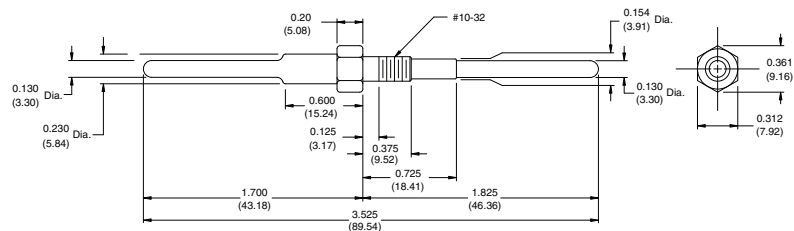

**Note:** All part numbers are RoHS compliant.

## ICCON Connector Electrical Performance

### Right Angle Socket

Part Number 6643232-1

### Right Angle Pin

Part Number 6643281-1

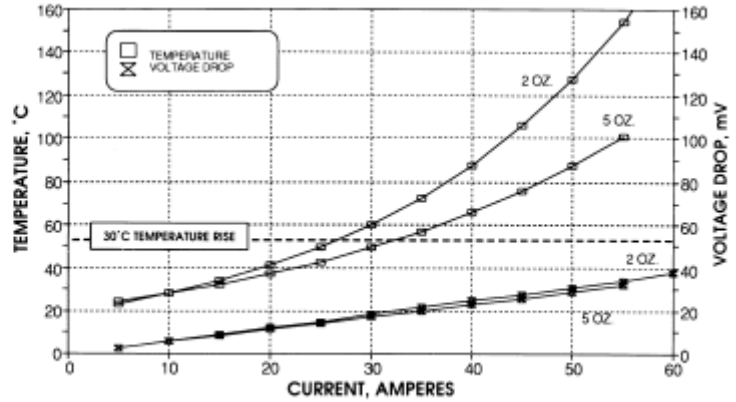
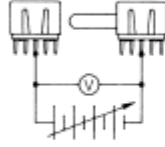

### Vertical Socket

Part Number 6643264-1

### Discrete Pin

Part Number 1766163-1

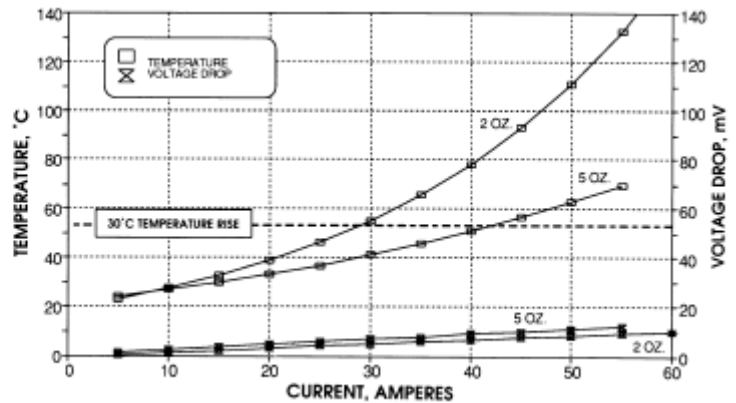
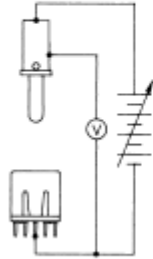

### Specifications

Finishes	
Crowns	30 microinches Gold plated over nickel
Pin Contacts	Silver over nickel
Material	
Housing	Polyester, 30% glass-filled, UL 94V-0 black
Body	Metal Alloy
Pin Contacts	Brass
Crowns	Beryllium Copper
Electrical	
Ratings	UL (USR) 35A at 250V
	UL (CNR) 25A at 250V

**Note:** All part numbers are RoHS compliant.



**ICCON SLIMLINE Connectors (.100 x .100 Footprint)**

**Parallel Pin**

Part Number 6643228-1 Solder  
 Part Number 6643227-1 Solder w/Locking Feature  
 Part Number 6643222-1 Compliant  
 Part Number 6643223-1 Compliant w/ Locking Feature

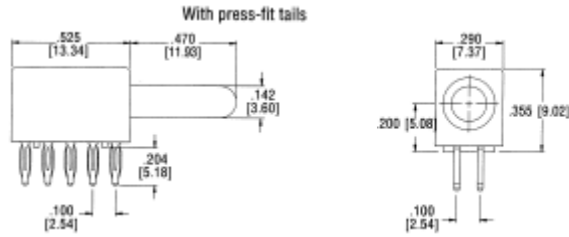

**Parallel Socket**

Part Number 6643229-1 Solder  
 Part Number 6643220-1 Press-Fit

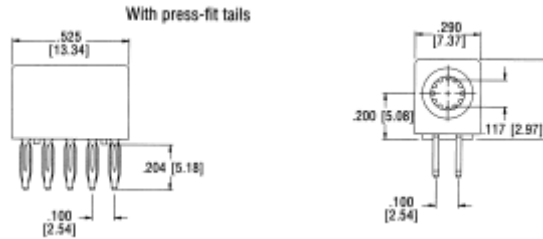

**Connector Mounting**

The ICCON SLIMLINE Connector is optimized for a board thickness of .093" (2.38 mm), but can be successfully used on boards from .062" to .125" (1.58 mm to 3.17 mm)

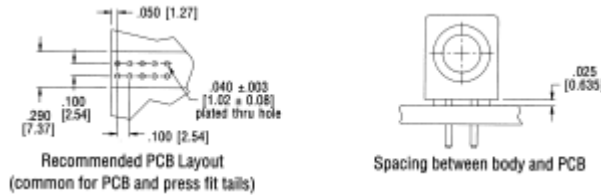

**Specifications**

<b>Finishes</b>	
Crowns	30 microinches Gold plated over nickel
Pin Contacts	Silver over nickel
<b>Material</b>	
Housing	Polyester, 30% glass-filled, UL 94V-0 black
Body and pin contacts	Brass
Crowns	Beryllium Copper
<b>Electrical</b>	
Ratings	UL (USR) 35A at 250V
	UL (CNR) 25A at 250V
Voltage drop at UL rating	27.2mV

**Contact System Performance, ICCON SLIMLINE Connector  
 Current Ratings vs. mV Drop/Temperature Rise**

Non-locking version, mounted on 2 oz. and 5 oz. copper boards

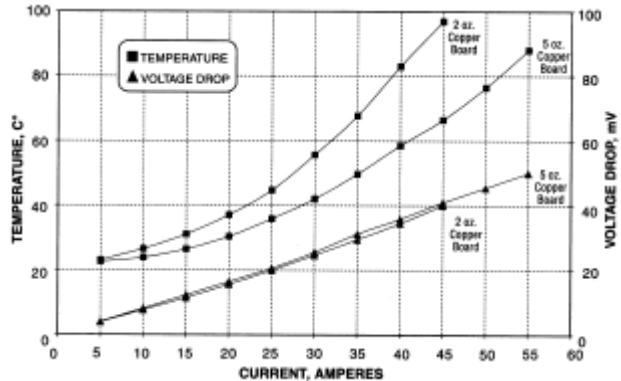

**Note:** All part numbers are RoHS compliant.

## Mini Power Modules

### Product Facts

- **Hard Metric design compatible with Z-PACK 2mm HM, Z-PACK HM-Zd, MULTIGIG RT and Futurebus+ Connectors**
- **Sequenced contact options for “make-first-break-last” applications**
- **Compliant press-fit connections to PCB**
- **High Durability  
250 Cycles — MULTIGIG RT, UPM Connectors  
100 Cycles — Futurebus+ Connectors**
- **Optional Guide Pins & Sockets for blind-mate applications**
- **Bellcore approved (contact Tyco Electronics for specific part numbers)**
- **Recognized to US and Canadian requirements under the Component Recognition program of Underwriters Laboratories, File #E28476**
- **Produced under a Quality Management System certified to ISO 9001**

A copy of the certificate is available upon request.

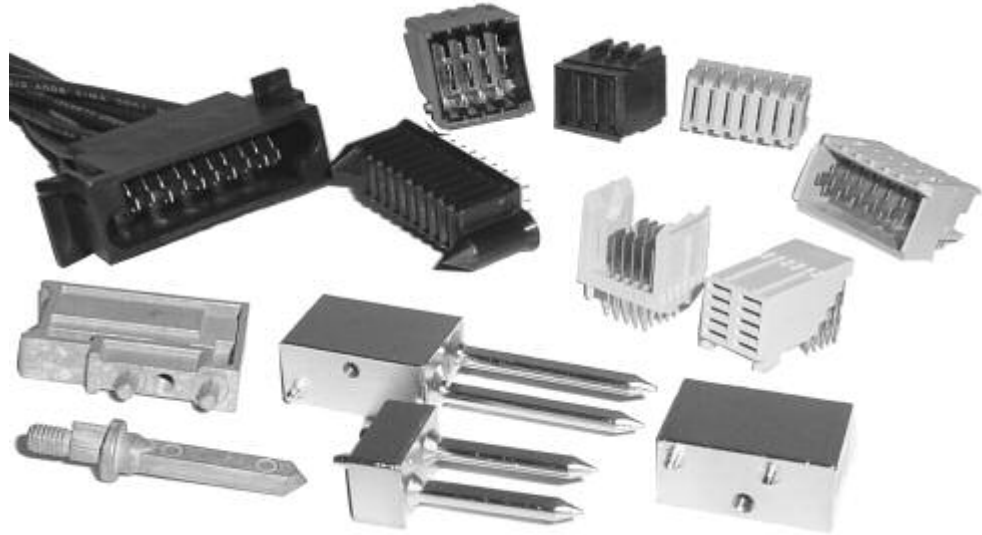

The Tyco Electronics Mini Power Module family of products are designed specifically to compliment the Hard Metric board-to-board backplane interconnects. These products include, MULTIGIG RT, Z-PACK 2mm HM, Z-PACK HM-Zd, Futurebus+ and other Connectors. Available in “Standard” and “Reverse” orientations, the power modules can provide touch-safe protection (per IEC 60950) to either side of the connection (backplane or daughter card.)

Both the headers and receptacle offer compliant pin connections to the pcb. The Universal Power Module and MULTIGIG RT Connectors use the ACTION PIN Contact compliant design to provide maximum surface connection to the plated through hole. The range of products offers power contacts rated as low as 3 amps per contact (Futurebus+ Connectors) up through

20 Amps per contact (MULTIGIG RT Connectors). In addition, the newest products offer high conductivity contacts which improve the current carrying capacity by as much as 50%.

The low contact normal force, available lubricated surface coating (UPM) and high conductivity materials combine to produce a high durability cycle rating and high current density. In addition, the high temperature housing and contact materials make these power modules suitable for a wide variety of applications including modular hot-swap power supplies used in computer, telecommunications, medical, and industrial equipment.

Generous alignment features designed into the housings on the Mini Power Drawer Connector and optional guidance hardware make these Power Modules ideal for blind-mating applications.

### Need more information?

Call Technical Support at the numbers listed below.

Technical Support is staffed with specialists well versed in all Tyco Electronics products. They can provide you with:

- Technical Support
- Catalogs
- Technical Documents
- Product Samples
- Tyco Electronics Authorized Distributor Locations

## Mini Power Modules for PCB-to-PCB Power Distribution

### MULTIGIG RT Power Modules

The newest of the power modules. Designed specifically for use with Tyco Electronics 2mm Backplane Connectors. Suitable for 0.8mm Card Spacing and made from high conductivity copper alloys, these power modules offer improved power density and high cycle life. The distribution to the pcb is through **six ACTION PIN compliant tails** which offer maximum surface area contact to the plated through hole. The design offers electrical protection with its sacrificial contact design and mechanical protection by recessing the power contacts. Contacts are rated for up to 20 Amps per contact, which delivers up to **120 Amps per linear inch**. Three contact mating lengths are available, in 1.5mm sequence levels.

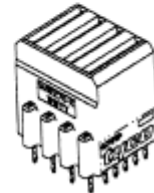
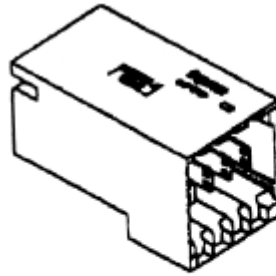

- Designed for Hot-Plug Operation
- 6 pcb tails per contact

### Universal Power Module (UPM)

Also designed to complement Tyco Electronics 2mm Backplane Connectors, the design meets IEC 60950 touch-safe requirements by reversing the orientation as compared to the Futurebus+ Power Modules. The touch-safe receptacle is applied to the "hot" side, which is typically the backplane side of the connection. Offered in both a Standard Power grade, rated at 10 Amps per contact and High Power grade which carries 16 Amps per contact — resulting in up to **100 Amps per linear inch**. Hot-plug design and low normal force provide high durability and high reliability. Three contact mating lengths are available in 1.6mm sequence levels. Multiple contact sequence patterns are available.

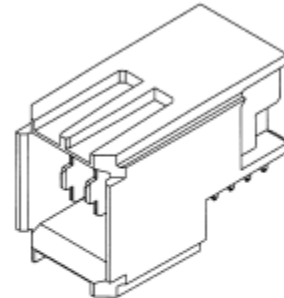
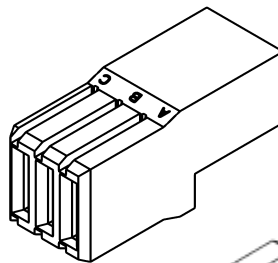

- Lubricated for Environmental Protection
- Designed for Hot-Plug
- 4 pcb Tails per Contact

### Z-PACK 2mm Futurebus+ Power Modules

The power modules, designed to IEC 61076-4-OX, are used along with Tyco Electronics Futurebus+ Backplane Connectors. The contacts are rated for 3 Amps and fully loaded will carry approx. 50 Amps per linear inch. Three contact mating lengths available in 0.75mm increments.

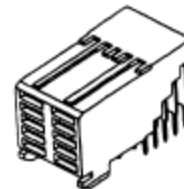
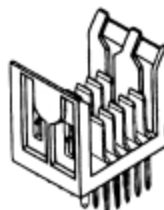

## MULTIGIG RT Power Modules

### Right Angle Headers

#### Material and Finish

- Housing** — Liquid Crystal Polymer
- Contacts** — Phosphor Bronze
- Plating** — .000050 [0.00127] min gold in mating area. .000020 [0.000508] min. tin on pcb tail over .000050 [0.00127] min. nickel over all

#### Related Product Data

- Guiding Hardware (Optional)** — pages 56 and 57
- Seating Tooling** —
  - Headers — No tool required
  - Flat Rock
- Receptacles — See application specification

#### Technical Documents

- Product Specification** 108-2062
- Application Specification** 114-13062

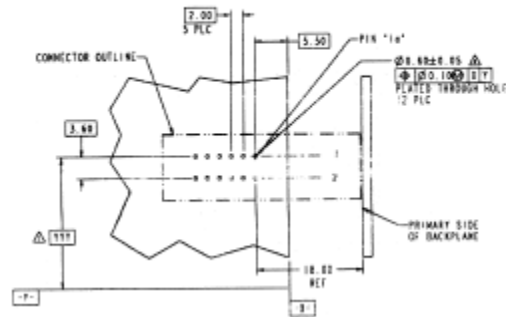
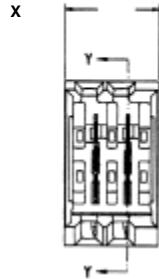
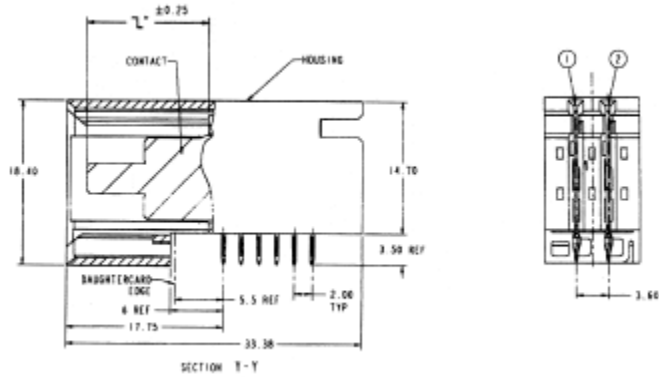

Recommended PC Board Hole Layout Daughtercard Primary Side

No. Positions	Dimension X	Sequence	Part Number
2	0.417 [10.6]	L,L	1410279-7
		M,L	1410279-8
		S,L	1410279-9
		S,S	1-1410279-0
		S,M	1-1410279-1
		M,M	1-1410279-2
4	0.701 [17.8]	L,L,L,L	1-1410271-1
		M,L,L,M	1-1410271-2
		S,L,L,M	1-1410271-3
		S,L,L,S	1-1410271-4
		S,M,L,M	1-1410271-5
		M,M,M,M	1-1410271-6
		S,M,M,S	1-1410271-7
		S,S,S,S	1-1410271-8
		M,S,S,M	2-1410271-0

Sequencing reads left-to-right along mating face.  
 L (long) = 0.541 [13.75], M (medium) = 0.482 [12.25], S (short) = 0.423 [10.75]

**Note:** All part numbers are RoHS compliant.

**MULTIGIG RT Power Modules**

**Vertical Receptacle**

**Material and Finish**

- Housing** — Liquid Crystal Polymer
- Contacts** — Phosphor Bronze
- Plating** — 0.00127 (.000050) min gold in mating area. 0.000580 (.000020) min. tin on pcb tail over 0.00127 (.000050) min. nickel over all

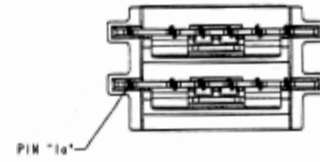
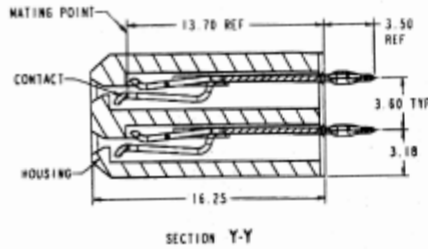

**Related Product Data**

- Guiding Hardware (Optional)** — pages 56 and 57
- Seating Tooling** — Headers — No tool required — Flat Rock Receptacles — See application specification

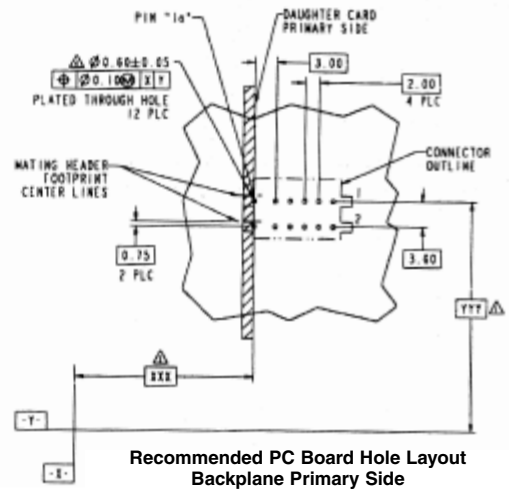
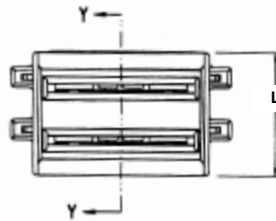

**Technical Documents**

- Product Specification** 108-2062
- Application Specification** 114-13062

No. Positions	Dimension L	Part Number
2	0.333 [8.45]	1410278-2
4	0.616 [15.65]	1410270-2

**Note:** All part numbers are RoHS compliant.

**Universal Power Module (UPM)**

**Right Angle Plug**

**Material and Finish**

**Housing** — PBT  
Natural color UL 94V-0

**Contacts** —  
**Standard Power** —  
Phosphor Bronze

**High Power** —  
High Conductivity Copper Alloy

**Plating** — 0.00127 (.000050) min. gold in mating area, 0.0050 (.00020) min. tin-lead on ACTION PIN post area, with entire contact underplated 0.00127 (.000050) min. nickel

- Notes:** 1. Environmental lubrication pre-applied  
2. RoHS compliant parts have tin plated ACTION PIN posts

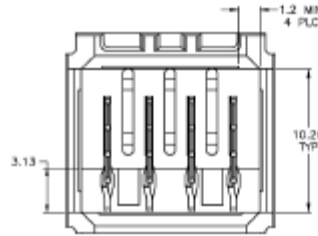
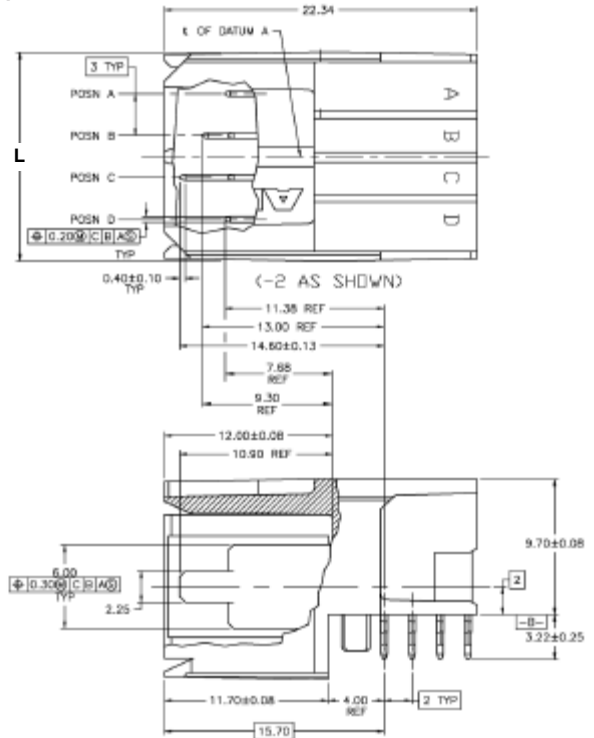
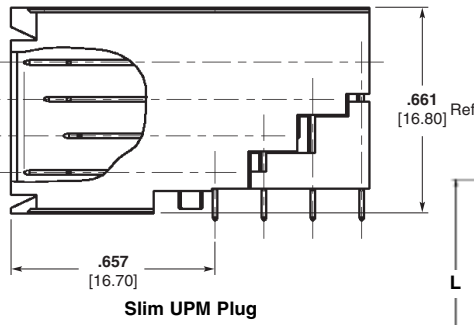

**Related Product Data**

- Durability** — 250 cycles  
**Guiding Hardware (Optional)** — pages 56 and 57  
**Seating Tooling — Header**  
Seating Tool 224441-1  
Board Support Fixture 224442-1  
**Receptacle**  
Seating Tool 224421-1  
Board Support Fixture 217602-1

**Technical Documents**

- Product Specification**  
108-1651  
**SLIM UPM Product Specification**  
108-78387  
**Application Specification**  
114-1103

- Instruction Sheet**  
408-4169 (Receptacle Seating Tool 224421-X)

Number Positions	Dimensions L	Standard Power 10 Amps/Contact Sequence* Pattern	Part Number	High Power 16 Amps/Contact Sequence* Pattern	Part Number
3	0.472 [12.0]	L,L,L	5223961-1	M,M,M	5-5223961-1
		M,L,M	5223963-1	M,L,M	5-5223963-1
4	0.591 [15.0]	L,L,L,L	5646954-1	L,L,L,L	120954-1
		S,M,L,S	5646954-2	L,M,S,S	120954-2
5	0.709 [18.0]	L,L,L,L,L	5646955-1	L,L,L,L,L	120955-1
		M,M,M,M,L	5646955-2	M,M,L,M,M	120955-2
6	0.827 [21.0]	L,L,L,L,L,L	5646956-1	L,L,L,L,L,L	120956-1
		L,M,M,M,M,L	5646956-2	L,M,S,S,S,S	120956-2
7	0.945 [24.0]	L,L,L,L,L,L,L	5646957-1	L,L,L,L,L,L,L	120957-1
		**	**	L,S,S,L,S,S,L	120957-2
8	1.063 [27.0]	L,L,L,L,L,L,L,L	5646958-1	L,L,L,L,L,L,L,L	120958-1
		L,S,L,S,L,S,L,S	5646958-2	L,M,S,S,S,S,S,S	120958-2

\*Sequencing Reads left-to-right along mating face.  
L (long) = 0.429 [10.9], M (medium) = 0.366 [9.3], S [short] = 0.302 [7.68]  
\*\*Other sequence patterns available. See on-line customer drawing.

**Slim UPM Right Angle Plug**

Number Positions	Width	Part Number
4	0.335 [8.5]	1903977-1 1903977-2

**Note:** All part numbers are RoHS compliant.



**Universal Power Module (UPM) (Continued)**

Board-to-Board Products

**Vertical and Right Angle Receptacles**

**Material and Finish**

**Housing** — PBT

Natural color

UL 94V-0

**Contacts** —

**Standard Power** —

Phosphor Bronze

**High Power** —

High Conductivity Copper Alloy

**Plating** — 0.00127 (.000050) min. gold in mating area, 0.0050 (.000020) min. tin-lead on ACTION PIN post area, with entire contact underplated 0.00127 (.000050) min. nickel

- Notes:** 1. Environmental lubrication pre-applied  
2. RoHS compliant parts have tin plated ACTION PIN posts

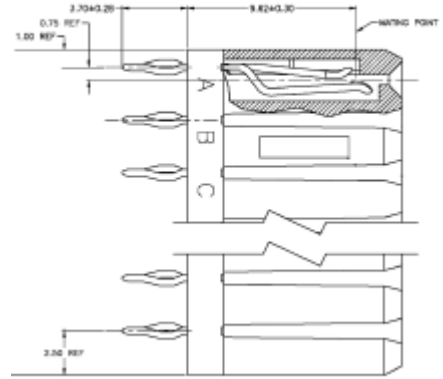
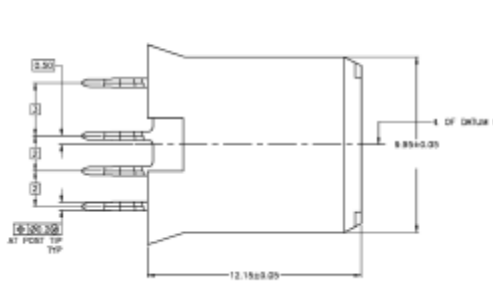

**Related Product Data**

**Durability** — 250 cycles

**Mating Force** — 1.0N per contact

**Unmating Force** — .5N per contact

**Guiding Hardware (Optional)** — pages 56 and 57

**Seating Tooling** —

**Header**

Seating Tool 224441-X

Board Support Fixture 224442-1

**Receptacle**

Seating Tool 224421-1

Board Support Fixture 217602-1

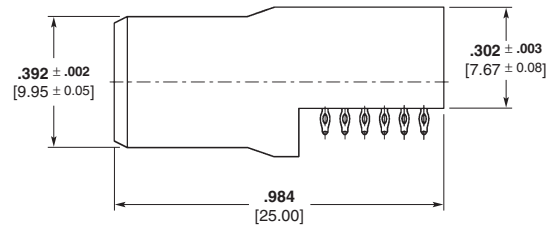
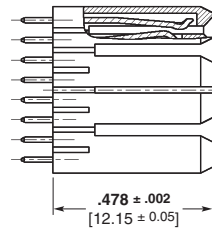

**Right Angle  
Part Number 120943**

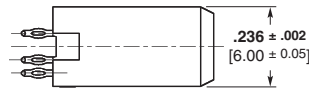

**Part Number 1903978**

**Technical Documents**

**Product Specification**

108-1651

**Application Specification**

114-1103

**Instruction Sheet**

408-4169 (Receptacle)

Seating Tool 224421-X)

No. Circuit Positions	Vertical		Right Angle
	Standard Power 10 Amps/Contact Part Numbers	High Power 16 Amps/Contact Part Numbers	High Power 16 Amps/Contact Part Numbers
3	5223955-2	5-5223955-2	120943-1
4	5223995-1	120953-1	120943-2
5	5223995-2	120953-2	120943-3
6	5223995-3	120953-3	120943-4
7	5223995-4	120953-4	120943-5
8	5223995-5	120953-5	120943-6
9	5223995-6	120953-6	120943-7

**Slim UPM Vertical Receptacle**

Number of Positions	Width	Part Number
4	.236 [6.00]	1903978-1
		1903978-2

**Note:** All part numbers are RoHS compliant.

## Z-PACK 2mm Futurebus+ Power Modules

### Vertical Pin Assemblies with Solder Leads and Compliant Press-Fit Leads

#### Material and Finish

**Housing** — Liquid crystal polymer  
**Pin Contacts** — Phosphor bronze, mating surface plating conforms to all testing specified for Telcordia Uncontrolled Environment, with entire contact underplated with 0.00127 min. nickel. See customer drawing for specific lead plating.

#### Related Product Data

**Current Rating** — 5 Amperes per contact  
**Mating Force** — 2.4N per contact max.  
**Unmating Force** — 0.3N per contact max.  
**Durability** — 250 cycles

#### Technical Documents

##### Product Specification

108-1441

##### Application Specification

114-1075

##### Instruction Sheets

408-6927, 408-4157, 408-4488

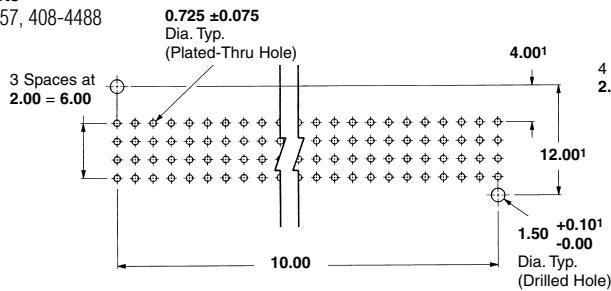
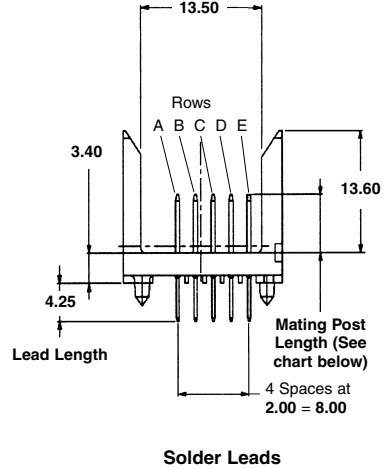
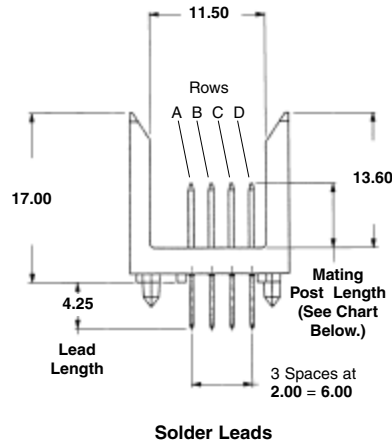
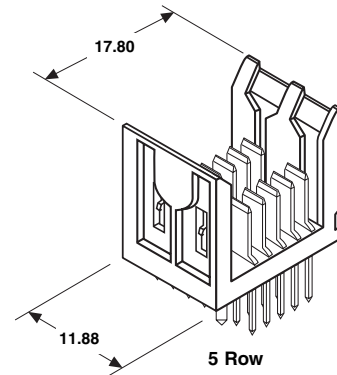
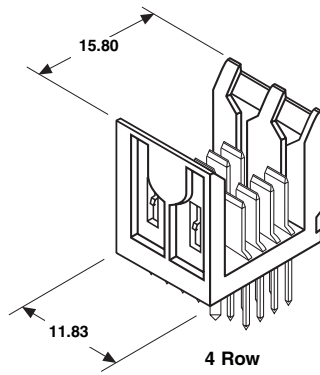

Recommended PC Board Hole Layout per IPC-D-300, Type II, Class C (Component Side)

<sup>1</sup>Dimensions apply to solder lead versions only.

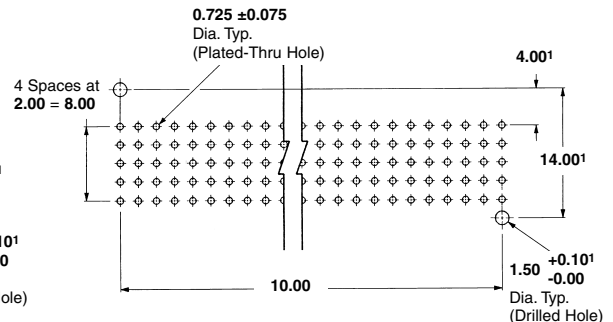

Recommended PC Board Hole Layout per IPC-D-300, Type II, Class C (Component Side)

<sup>1</sup>Dimensions apply to solder lead versions only.



Number of Positions	Mating Post Lengths	Part Numbers			
		4.25 Solder Lead	3.2 Solder Lead	Press-Fit	Seating Tooling
8	.256 [6.50]	5536600-1	5536628-1	5536603-1	58512-1
	.285 [7.25]	5536625-1	—	—	
	.315 [8.00]	5536623-1	—	5536620-1	
10	.256 [6.50]	—	—	5536642-1	1214224-1
	.315 [8.00]	—	—	5536642-7	

**Note:** All part numbers are RoHS compliant.

**Z-PACK 2mm Futurebus+ Power Modules** (Continued)

**Right Angle Receptacle Assemblies with Solder Leads and Compliant Press-Fit Leads**

**Material and Finish**

**Housing** — Liquid crystal polymer  
**Receptacle Contacts** — Phosphor bronze, mating surface plating conforms to all testing specified for Telcordia Uncontrolled Environment, with entire contact underplated with 0.00127 min. nickel. See customer drawing for specific lead plating.

**Technical Documents**

**Product Specification**

108-1441

**Application Specification**

114-1075

**Instruction Sheets**

408-6927

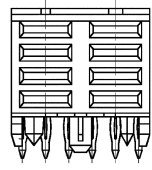

4 Row

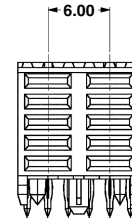

5 Row

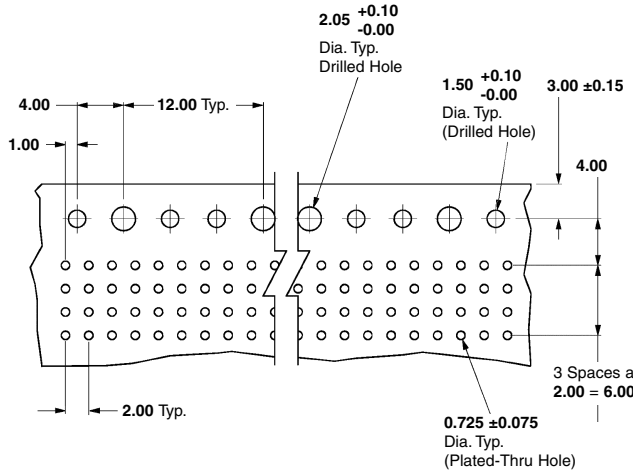
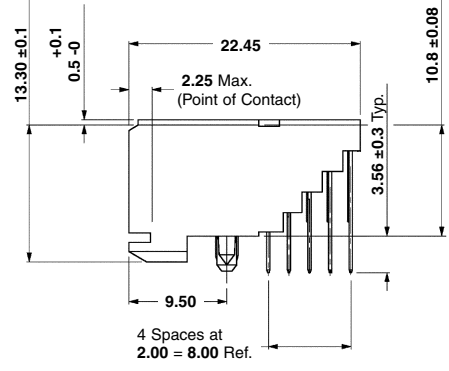
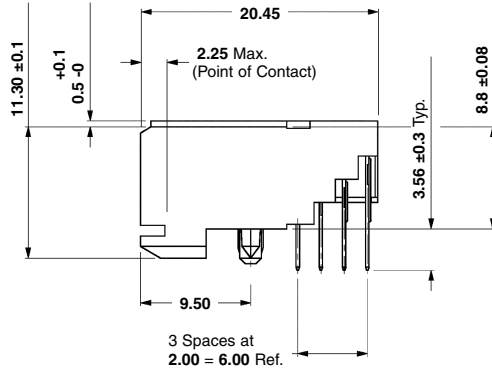

**Recommended PC Board Hole Layout per IPC-D-300, Type II, Class C (Component Side)**

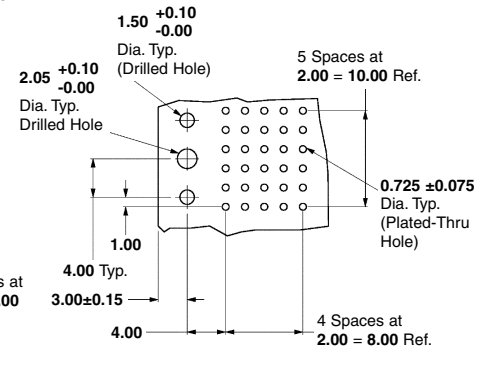

**Recommended PC Board Hole Layout per IPC-D-300, Type II, Class C (Component Side)**

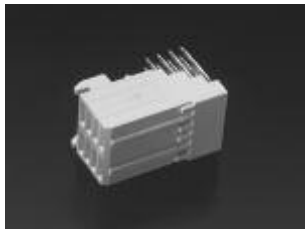

Number of Positions	Part Numbers			Seating Tool
	Solder Tail Length		Press-Fit 0.140 [3.56]	
	0.107 [2.73]	0.139 [3.53]		
8	5536607-1	5536613-1	5536614-1	Industry Standard Flat Rock
10	5223092-1	5223093-1	5536649-1	Industry Standard Flat Rock

**Note:** All part numbers are RoHS compliant.

## Custom Loading Worksheet for Mini Power Modules

Any of the Mini Power Modules can be made available with selectively loaded or sequenced contact arrangements. Complete the form below and discuss with your local Tyco Electronic Sales Engineer to get started. Minimum order quantities apply.

### Step 1

#### Select Product

MULTIGIG RT Product

- 2 Position
- 4 Position

Universal Power Modules (UPM)

- 3 Position
- 4 Position
- 5 Position
- 6 Position
- 7 Position
- 8 Position
- FB Power

Z-PACK 2mm Futurebus+ Power Products

- 4 Row
- 5 Row

MULTIGIG RT Product

- L, Long Blade — 0.541 [13.75]
- M, Medium Blade — 0.482 [12.25]
- S, Short Blade — 0.423 [10.75]

Universal Power Modules (UPM)

- L, Long Blade — 0.429 [10.9]
- M, Medium Blade — 0.366 [9.3]
- S, Short Blade — 0.303 [7.7]

Z-PACK 2mm Futurebus+ Power Products

- AA, Mating Post Length — .256 [6.50], Press-Fit, Lead Length — .167 [4.25]
- AB, Mating Post Length — .285 [7.25], Press-Fit, Lead Length — .167 [4.25]
- AC, Mating Post Length — .315 [8.00], Press-Fit, Lead Length — .167 [4.25]
- AD, Mating Post Length — .197 [5.00], Press-Fit, Lead Length — .167 [4.25]
- CA, Mating Post Length — .256 [6.50], Solder, Lead Length — .167 [4.25]
- CB, Mating Post Length — .285 [7.25], Solder, Lead Length — .167 [4.25]
- CC, Mating Post Length — .315 [8.00], Solder, Lead Length — .167 [4.25]
- CD, Mating Post Length — .256 [6.50], Solder, Lead Length — .125 [3.20]
- CE, Mating Post Length — .285 [7.25], Solder, Lead Length — .125 [3.20]
- CF, Mating Post Length — .315 [8.00], Solder, Lead Length — .125 [3.20]

**Note:** Mating Length Symbols

### Step 2

#### MULTIGIG RT Products

Circuit Position  
Mating Length

Write-in Mating Length Symbol (L,M,S) per blade

1	2	3	4

#### Universal Power Module (UPM)

Circuit Position  
Mating Length

A	B	C	D	E	F	G	H

#### Z-PACK 2mm Futurebus+ Power Products

- Solder Tail
- Press-Fit
- 4 Row
- 5 Row

	A	B	C	D	E
1					
2					

(Enter mating length symbols in Rows A through D)

(Enter mating length symbols in Rows A through E)

**Backplane and Co-Planar Guide Modules**

**Un-keyed Guide Modules**

Stainless Steel Pin  
Die Cast Receptacle  
Multiple thread lengths available  
Gatherability +/-0.100"

Seating Tool — Part Number 224440-1  
Board Support Fixture —  
Part Number 217603-1

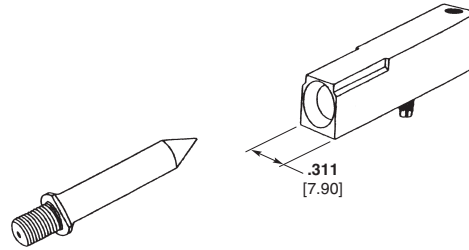

Type	Vertical Guide Pin Part Number	Right Angle Guide Module Part Number
M4, 6.2mm Thread Length	223956-1	5223957-1 (As Shown)
M4, 7.5mm Thread Length	223982-1	
M4, 12.7mm Thread Length	223969-1	
8-32, 12.7mm Thread Length	223969-4	5223979-1 (with Dual Mounting Position)
M4, 9.2mm Thread Length	223969-7	

**Keyed Guide Modules**

Die Cast Pin and Receptacle  
Keyed to prevent mis-mating daughter cards  
Multiple thread lengths available  
Gatherability +/-0.100"

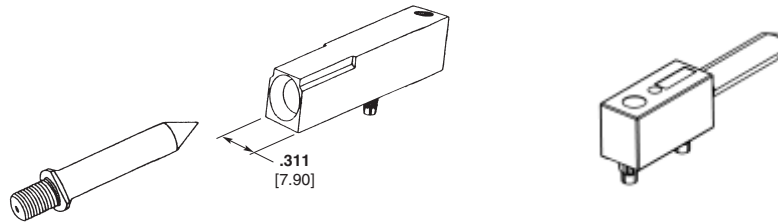

Type	Right Angle Guide Module		Vertical Pin	Right Angle Pin
	4-40	M2.5		
0°	5223986-1	5120913-1	5223985-1	1469265-1
90°	5223986-3	5120913-3		1469265-2
180°	5223986-5	5120913-5		1469265-5
225°	5223986-6	5120913-6		1469265-6

**AdvancedTCA Guide Modules**

Die Cast Pins and Receptacles  
Keyed to prevent mis-mating daughter cards  
Twin Pins — provide more keying options  
Meets PICMG 3.0 Specifications  
Gatherability +/-0.50"

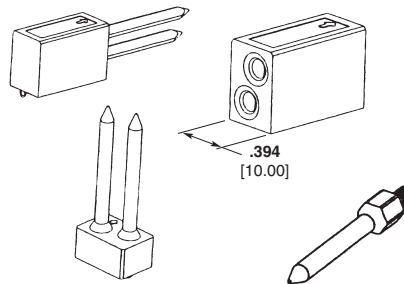

Type	Part Number			AdvancedTCA Module Designation
	Both Pins Keyed 0°	Top Pin Keyed 270° Bottom Pin Keyed 90°	Not Keyed	
Right Angle Pin Long	1-1469372-1	3-1469372-7	—	A2
Vertical Pin Short	1-1469387-1	3-1469387-7	—	A1
Vertical Pin Long	1-1469388-1	3-1469388-7	—	A2
Right Angle Receptacle	1-1469373-1	3-1469373-7	1469374-1	K1/K2
Single Pin Rear Assembly	—	—	1469269-X*	rK1

\*-X identified by PCB thickness. See customer drawing for details.

AdvancedTCA is a trademark of PICMG-PCI Industrial Computer Manufacturers Group, Inc.

**Note:** All part numbers are RoHS compliant.

**Backplane and Co-Planar Guide Modules (Continued)**

**10.8 Guide Modules**

Rugged design — to support heavier cards  
 Better gatherability +/-3.5mm  
 10.8mm width  
 Die Cast Pin  
 Die Cast Receptacle  
 ESD Ground Option  
 Finish: Nickel plated

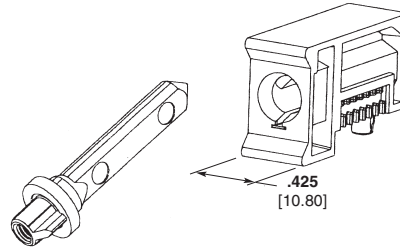

Type	Part Numbers			
	Right Angle		Vertical Pin	
	With ESD	Without ESD	Internal M3.5 Thread	External M5 Thread
0	1-1410297-1	1-1410546-1		
90	1-1410297-3	1-1410546-3		
180	1-1410297-5	1-1410546-5	1410548-3	1-1410773-X
225	1-1410297-6	1-1410546-6		

\*See customer drawing for dash numbers

**9.0 VITA 46 Guide Modules**

Die Cast Pins and Receptacles  
 Keyed to prevent mis-mating daughter cards  
 Meets VITA 46 Specification  
 Gatherability +/-3.5mm  
 Finish: Silver plated

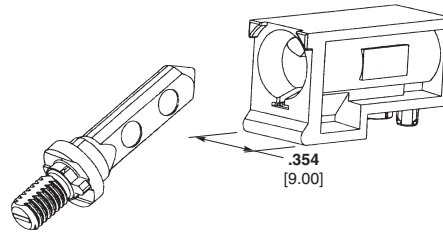

Type	Right Angle*	Part Number		
		Vertical Pin Thread Depth		
		10mm	11.6mm	13.1mm
0°	1-1469492-1			
45°	1-1469492-2			
90°	1-1469492-3			
270°	1-1469492-7	1-1469491-2	1-1469491-3	1-1469491-4
315°	1-1469492-8			
Un-keyed	1-1469492-9			

\*Mounting screw Part Number 1410946-X required

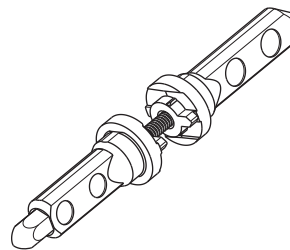

Type	Part Number
Double-Ended	1410956-1

**7.2 Thin Guide Modules**

Die Cast Pin and Receptacle  
 7.2mm width  
 Gatherability +/-2.5mm  
 Finish: Trivalent Chromium

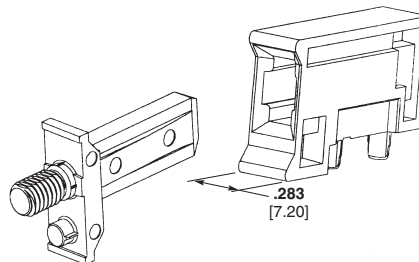

Right Angle	Part Number	
	Vertical Pin Thread Length	
	8.7mm	11.6mm
1410714-3	1-1410710-1	1-1410710-3

**Note:** All part numbers are RoHS compliant.



## Z1 Power Connector for AdvancedTCA Zone 1 Applications

### Product Facts

- Designed to PICMG 3.0 Standard
- High conductivity copper alloy on Size 16 power contacts
- .76 micro-meters [30 microinch] gold over 1.27 micrometers [50 microinch] nickel plating at contact interface
- Gold-thickness controlled on inside of socket and outside of pin — at contact interface points
- RoHS compliant
- Stainless steel spring provides contact normal force — resists relaxation at elevated temperatures
- Eye-Of-Needle compliant press-fit termination
- No special tools needed to seat connectors to pcb — standard Flat-Rock seating tools
- Additional pcb retention hardware not required

### Technical Documents

**Product Specification** —

108-2216

**Application Specification** —

114-13156

**Industry Standard** —

PICMG 3.0, Rev. 2.0

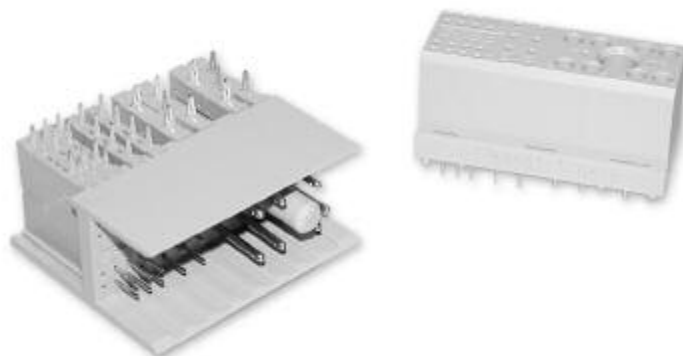

### Introduction

Tyco Electronics supplies both the power and the signal connectors specified in the Advanced Telecommunications Computer Architecture (AdvancedTCA) Standard. This standard (PICMG 3.0) is one of the latest standards addressing future telecommunications needs. The AdvancedTCA Power Connector, designated for use in Zone 1 per PICMG 3.0, combines 8 High Conductivity Size 16 pin & socket contacts along with 22 Size 22 pin & socket contacts, plus guidance into a compact interface. Both connector halves feature proven compliant press-fit contacts for easy solder-less termination to printed circuit boards.

Based on years of reliable long-term field installations the power contact design is based upon Tyco Electronics' famous Type III+ contact design. By adding the use of a high conductivity copper alloy and the low-force Eye-Of-Needle compliant

pin section, the new contact delivers both ease of installation (with flat-rock seating tools) as well as industry-leading current carrying capability. The power contacts are capable of carrying 20 amps per contact and the signals are capable of carrying 2 amps per contact.

The housing design also offers improvements compared to other industry alternatives. The lead-in design for the contact cavities provides better resistance from contact stubbing. The contact retention has also been designed to eliminate the need for additional hardware sometimes used to hold the connectors to the pcb after pressing in to the pcb.

The result is a connector which is easy to install, meets all the PICMG 3.0 performance requirements and stays retained to the pcb without the additional labor required to add hardware.

### Typical Electrical Properties

**Current Ratings** — tested in accordance with CSA C22.2 No. 182.3-M1987 and IEC 60512-3, Test 5a requirements:

Positions 1–24, 27, 32 — 1 Amp each, per the PICMG 3.0 Specification

Positions 25, 26, 28–31, and 34 — 20 Amps each, exceeds the PICMG 3.0 Specification

**Dielectric Withstanding Voltage** —

Positions 1–16 — 1000 Volts rms

Positions 17–24 — 2000 Volts rms

Positions 25–34 — 2000 Volts rms

### Environmental Parameters

**Maximum Continuous Operating Temperature** — 105°C

**Durability Rating** — 250 cycles, per PICMG 3.0

AdvancedTCA and PICMG are trademarks of the PICMG-PCI Industrial Computer Manufacturers Group, Inc.

**Z1 Power Connector for AdvancedTCA Zone 1 Applications (Continued)**

**Front Board Connector  
Right Angle, 30 Position,  
Compliant Press-Fit**

**Part Number 1766500-1  
(tin plated pcb tails)**

**Part Number 1766500-2  
(tin-lead pcb tails)**

**Right Angle Plug,  
22 Position, Compliant  
Press-Fit**

**Part Number 1766502-1  
(tin plated pcb tails)**

**Part Number 1766502-2  
(tin-lead pcb tails)**

**Material and Finish**

**Insulators** — Thermoplastic, glass reinforced, UL 94V-0

**Signal Pins** — Copper alloy

**Power Contacts** — High conductivity copper alloy, plated 0.00076 [.000030] min. gold in mating area over 0.00127 [.000050] min. nickel

**Compliant PCB Tails** — 0.0030 – 0.0043 [.000120 – .000170] tin plated, matt finish

**Notes:**

1. Mounting hardware — self tapping screw (customer supplied) can be used but not required
2. Positions 1–4 not populated and reserved for future use.

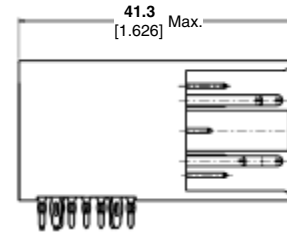
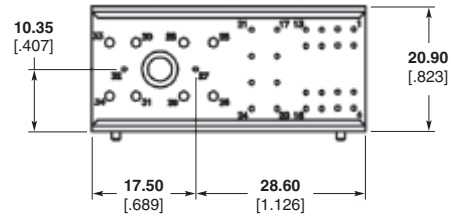

**Backplane Connector  
Straight, 30 Position,  
Compliant Press-Fit**

**Part Number 1766501-1  
(tin plated pcb tails)**

**Part Number 1766501-2  
(tin-lead pcb tails)**

**Straight, 22 Position,  
Compliant Press-Fit**

**Part Number 1766503-1  
(tin plated pcb tails)**

**Part Number 1766503-2  
(tin-lead pcb tails)**

**Material and Finish**

**Insulators** — Thermoplastic, glass reinforced, UL 94V-0

**Signal Pins** — Copper alloy

**Power Contacts** — High conductivity copper alloy, plated 0.00076 [.000030] min. gold in mating area over 0.00127 [.000050] min. nickel

**Compliant PCB Tails** — 0.0030 – 0.0043 [.000120 – .000170] tin plated, matt finish

**Note:** Positions 1–4 not populated and reserved for future use.

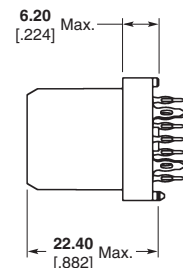
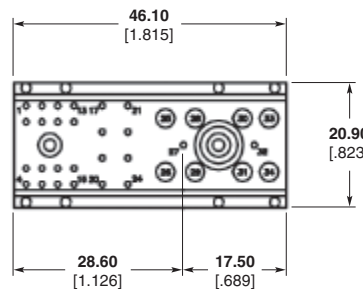

**Note:** All part numbers are RoHS compliant.