

# Beacons and indicator banks

## Beacons and indicator banks Ø 70 mm

### Harmony type XVD Application

Complete pre-cabled beacons and indicator banks and separate components for customer assembly



Complete pre-cabled beacon XVD fitted with "flash" discharge tube

Complete pre-cabled indicator bank XVD fitted with 2 illuminated units and 1 audible unit

#### Presentation

Ø 70 mm beacons and indicator banks type XVD are available in 2 forms:

■ **Complete pre-cabled products**

Depending on the model, they are "ready to use":

- with 1, 2, 3 or 4 illuminated signalling units (light source included),
- with or without "flash" unit,
- with or without audible signalling unit (buzzer),
- with fixing base.

The complete pre-cabled indicator banks cannot be modified due to the wiring.

■ **Customer assembled products**, using separate components for customised configuration.

#### Light signalling

■ 6 catalogued illuminated unit lens colours (green, red, orange, blue, clear and yellow) are available as separate components. These illuminated units can be fitted with steady or flashing light signalling LEDs which provide a long service life by considerably reducing heating and power consumption. However, incandescent bulbs can also be used.

■ A light diffuser, pre-fitted in illuminated units with a base mounted LED (1), distributes the light evenly over the lens surface. When using the indicator banks in bright ambient light conditions, remove the diffuser to improve contrast.

■ Some complete pre-cabled beacon and indicator bank models are available with a 5 Joule orange or red "flash" unit, but other colours (green, blue, yellow and clear) can be ordered as separate components.

#### Audible signalling

Complete pre-cabled indicator banks are supplied with or without an audible unit (buzzer), depending on the model selected.

- The volume of the audible signal is adjustable up to a value of 90 decibels at a distance of 1 m.
- Microswitches located in the audible unit enable selection of the signal frequency: continuous or intermittent tone.

#### Cabling and mounting

■ Complete pre-cabled Ø 70 mm beacons and indicator banks XVD have 300 mm long connecting wires protruding from the fixing base.

□ The wires have bared ends to enable direct connection, without the need for wire stripping etc. A label attached to the common (black wire) details the wire colour and associated unit in the bank, from bottom to top:

- brown: 1<sup>st</sup> unit,
- grey: 2<sup>nd</sup> unit,
- violet: 3<sup>rd</sup> unit,
- blue: 4<sup>th</sup> unit.

□ The connections to customer assembled products are made to a removable terminal block incorporated in the base unit.

■ The fixing of the combined units is assured by a single screw, the length of which depends on the number of units in the bank.

(1) Diffuser not compatible with units fitted with an incandescent bulb or "flash" discharge tube.

# Beacons and indicator banks

## Beacons and indicator banks Ø 70 mm

### Harmony type XVD Application

Complete pre-cabled beacons and indicator banks and separate components for customer assembly

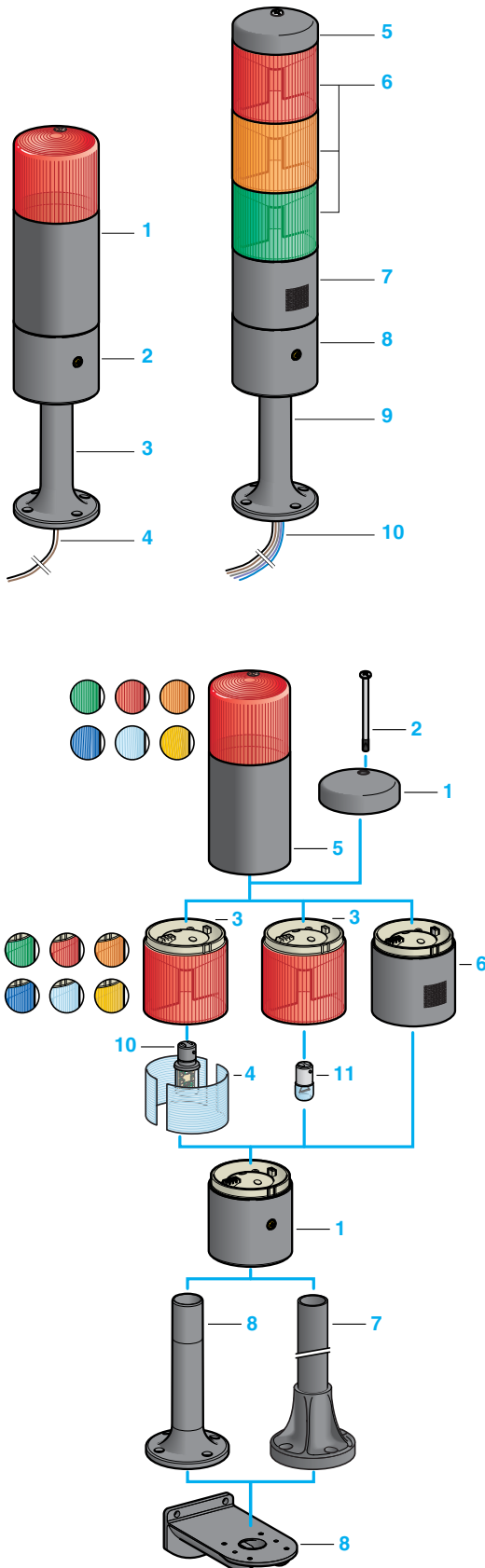

### Description

#### Complete pre-cabled Ø 70 mm beacons and indicator banks XVD

The assembled beacons comprise:

- 1 an illuminated unit with "flash" discharge tube (included) and orange or red lens,
- 2 a base unit,
- 3 a 100 mm high plastic fixing base (support tube with integral fixing plate), for raising the beacon 80 mm,
- 4 different coloured connecting wires with bared ends, length protruding from support tube: 300 mm.

The assembled indicator banks comprise:

- 5 a cover,
- 6 two, three or four illuminated units with red, green, orange or clear lens (depending on model) and light source (included),
- 7 an audible unit (buzzer), depending on model,
- 8 a base unit,
- 9 a 100 mm high plastic fixing base (support tube with integral fixing plate), for raising the indicator bank 80 mm,
- 10 different coloured connecting wires with bared ends, length protruding from support tube: 300 mm.

#### Breakdown of the reference for a complete indicator bank (1)

	XVD	Number of signalling units				
		1	2	3	4	
Voltage	$\approx$ 24 V $\sim$ 110 V $\sim$ 230 V	B G M				
Light source	Incandescent bulb LED	1 2				
Buzzer	Without With	(2) S				
Illuminated unit	Colour	Red Orange Green Clear	R A G C	R A G C	R A G C	R A G C
	Signalling	Steady "Flash"	(2) 6	(2) 6	(2) 6	(2) 6

#### Reference example

XVD B2SGR = indicator bank for  $\approx$  24 V supply voltage comprising a buzzer, one green lens illuminated unit and one red lens illuminated unit, both fitted with an LED.

#### Customer assembled Ø 70 mm indicator banks XVD

A **customised** indicator bank can be obtained by assembling:

- 1 a cover and a base unit incorporating a removable terminal block (3) with bottom cable entry,
- 2 a fixing screw for the combined units (4),
- 3 5 illuminated units maximum (5) with red, orange, green, blue or clear lens, light source not included (6),
- 4 a light diffuser (accessory that is only compatible with illuminated units fitted with an LED),
- 5 an illuminated unit with integral "flash" discharge tube (always mounted at the top of the bank),
- 6 an audible unit (buzzer),
- 7 a fixing base comprising an aluminium support tube glued into a plastic fixing plate, for raising the indicator bank by 80, 380 or 780 mm,
- 8 a plastic fixing base (support tube with integral fixing plate), height 100 mm,
- 9 a zamak fixing plate for use on a vertical support,
- 10 Base mounted LED,
- 11 Incandescent bulb.

(1) This table is purely for information and must not be used to create references.

(2) Not indicated, default value.

(3) Electrical connections to removable terminal block to be made by user.

(4) Variable length screw depending on the number of units to be combined. To be ordered separately, see page 35096-EN\_Ver3.0/6.

(5) Maximum configuration possibilities:

- 5 illuminated units mounted on base unit.
- 4 illuminated units + 1 "buzzer" mounted on base unit.

(6) Incandescent bulbs or LEDs to be ordered separately, see page 35096-EN\_Ver3.0/7.

# Beacons and indicator banks

## Beacons and indicator banks Ø 70 mm

### Harmony type XVD Application

Complete pre-cabled beacons and indicator banks and separate components for customer assembly

Environment			
<b>Conformity to standards</b>			EN/IEC 60947-5-1
<b>Product certifications</b>			UL, CSA, GOST
<b>Protective treatment</b>	Standard version		"TC"
<b>Ambient air temperature</b>	For storage	°C	- 40...+ 70
	For operation (1)	°C	<b>Illuminated units with steady light signalling:</b> - 25...+ 70, with 10 W max. incandescent bulb - 25...+ 50, with LED
		°C	<b>Illuminated units with flashing light signalling:</b> - 25...+ 50, with 7 W max. incandescent bulb - 25...+ 40, with 10 W max. incandescent bulb - 25...+ 50, with LED
		°C	<b>Illuminated units with "flash" discharge tube:</b> - 25...+ 50
		°C	<b>Audible units:</b> - 25...+ 50, with buzzer
<b>Electric shock protection</b> Conforming to IEC 536	Mounted on support tube		Class I with metal fixing plate Class II with plastic fixing plate
	Mounted on base unit		Class II
<b>Degree of protection</b>	Conforming to IEC 60529		IP 40
<b>Material</b>	Illuminated units		Polycarbonate
	Base unit and cover		Glass-reinforced polyamide and polycarbonate
	Fixing bases		Support tube with integral fixing plate: plastic (XVD C02) Aluminium support tube glued into plastic fixing plate (XVB Z0●)
	Fixing plate XVB C12 for use on vertical support		Zamak
Electrical characteristics			
<b>Rated insulation voltage</b> (U <sub>i</sub> )	Conforming to IEC 60947-1	<b>V</b>	250
<b>Voltage limits</b>	Conforming to IEC 60947-5-1	<b>G</b>	0.85 to 1.10 U <sub>n</sub> (U <sub>n</sub> : nominal voltage)
<b>Consumption</b>	LED unit	<b>mA</b>	<b>Steady light signalling:</b> ~ 24 V: < 47 ~ 120 V: < 17 ~ 230 V: < 17
		<b>mA</b>	<b>Flashing light signalling:</b> ~ 24 V: < 47 ~ 120 V: < 17 ~ 230 V: < 17
	5 Joule "flash" discharge tube unit (on energisation)	<b>mA</b>	~ 24 V: < 550 --- 24 V: < 350 ~ 120 V: < 140 ~ 230 V: < 105
	Audible units	<b>mA</b>	~ 12...48 V: < 20 ~ 120...230 V: < 50
<b>Rated impulse withstand voltage</b>	Conforming to IEC 60947-1	<b>kV</b>	U <sub>imp</sub> = 4
<b>Light source</b>	Illuminated units with steady or flashing light signalling		Incandescent bulbs with BA 15d base fitting, maximum power 10 W LED with BA 15d base fitting
<b>Illuminating power</b>	Illuminated units with discharge circuit (integral discharge tube)	<b>cds</b>	13 (integral high intensity tube) with clear lens unit: 5 J tube
<b>Audible unit</b>	Continuous or intermittent tone	<b>dB</b>	90 at 1 m (adjustable: 70...90 dB)
	Fundamental frequency	<b>kHz</b>	2.8
<b>Terminal referencing</b>	Common to all 5 units		1 terminal referenced "C"
	Depending on number of units		1 or 5 terminals referenced 1 to 5
<b>Connection</b>	Maximum clamping capacity on protected, ready-to-tighten, screw and captive cable clamp terminals	<b>mm<sup>2</sup></b>	1 x 1.5 with cable end 1 x 0.82 with bared wire ends (complete products)
<b>Frequency of illuminated units</b>	Illuminated units with flashing light signalling	<b>Hz</b>	1
	Illuminated units with discharge tube	<b>Hz</b>	1

(1) **Warning:** illuminated units with incandescent bulbs must not be combined with LED illuminated units, due to the risk of overheating.  
Also, when different units (e.g. steady, flashing...) are combined, the maximum temperature is limited to that of the weaker unit.

# Beacons and indicator banks

## Beacons and indicator banks Ø 70 mm

### Harmony type XVD Application

#### Complete pre-cabled beacons and indicator banks



#### Complete pre-cabled beacons

Composition	Light source (included)	Voltage	Signalling colour (1)		Reference (2)	Weight kg
			Steady	"Flash"		
1 illuminated unit	"Flash" discharge tube 5 J	≈ 24 V	-	R	XVD BR6	0.600
			-	O	XVD BA6	0.600
	≈ 230 V	-	R	XVD MR6	0.600	
		-	O	XVD MA6	0.600	

#### Complete pre-cabled indicator banks

##### With 2 signalling units

Composition	Light source (included)	Voltage	Signalling colour (1)		Reference (2)	Weight kg
			Steady	"Flash"		
2 illuminated units	LED	≈ 24 V	G-R	-	XVD B2GR	0.553
			O-R	-	XVD B2AR	0.553
			LED + "flash" discharge tube 5 J	≈ 24 V	G	R
1 illuminated unit + 1 audible "buzzer" unit	"Flash" discharge tube 5 J	≈ 24 V	-	O	XVD BSA6	0.775

##### With 3 signalling units

Composition	Light source (included)	Voltage	Signalling colour (1)		Reference (2)	Weight kg
			Steady	"Flash"		
3 illuminated units	Incandescent bulb 10 W max.	≈ 24 V	G-O-R	-	XVD B1GAR	0.923
		≈ 230 V	G-O-R	-	XVD M1GAR	0.923
	LED	≈ 24 V	G-O-R	-	XVD B2GAR	0.698
		≈ 230 V	G-O-R	-	XVD M2GAR	0.698
	LED + "flash" discharge tube 5 J	≈ 24 V	G-O	R	XVD B2GAR6	0.898
		≈ 24 V	G-R	-	XVD B2SGR	0.718
2 illuminated units + 1 audible "buzzer" unit	LED	≈ 24 V	O-R	-	XVD B2SAR	0.718
			≈ 230 V	G-R	-	XVD M2SGR

##### With 4 signalling units

Composition	Light source (included)	Voltage	Signalling colour (1)		Reference (2)	Weight kg
			Steady	"Flash"		
4 illuminated units	LED	≈ 24 V	C-G-O-R	-	XVD B2CGAR	0.843
3 illuminated units + 1 audible "buzzer" unit	Incandescent bulb 10 W max.	≈ 24 V	G-O-R	-	XVD B1SGAR	1.088
		≈ 24 V	G-O-R	-	XVD B2SGAR	0.863
	≈ 230 V	G-O-R	-	XVD M2SGAR	0.863	

(1) Signalling colour: R: red; O: orange; G: green; C: clear.

(2) In the references, the colours are listed in the same order as the mounting of the illuminated units (from bottom to top).



# Beacons and indicator banks

## Beacons and indicator banks Ø 70 mm

### Harmony type XVD Application

#### Beacons for customer assembly



XVD L3●



XVD L4●●



XVD L6●●

#### Beacons for customer assembly

##### With steady light signalling

Description	Light source, to be ordered separately (1)	Colour	Reference	Weight kg
<b>Beacon comprising:</b> - 1 illuminated unit - 1 base unit	Incandescent bulb 10 W max., 250 V max. or LED	Green	XVD L33	0.255
		Red	XVD L34	0.255
		Orange	XVD L35	0.255
		Blue	XVD L36	0.255
		Clear	XVD L37	0.255
		Yellow	XVD L38	0.255

##### With integral flashing light signalling

Description	Light source, to be ordered separately (1)	Colour	Reference	Weight kg	
<b>Beacon comprising:</b> - 1 illuminated unit - 1 base unit	Incandescent bulb 10 W max., ~ 24 V, ~ 24...48 V or LED	Green	XVD L4B3	0.275	
		Red	XVD L4B4	0.275	
		Orange	XVD L4B5	0.275	
		Blue	XVD L4B6	0.275	
		Clear	XVD L4B7	0.275	
		Yellow	XVD L4B8	0.275	
		Incandescent bulb 10 W max., ~ 48...230 V or LED	Green	XVD L4M3	0.275
			Red	XVD L4M4	0.275
Orange	XVD L4M5		0.275		
Blue	XVD L4M6		0.275		
Clear	XVD L4M7		0.275		
Yellow	XVD L4M8		0.275		

##### With 5 Joule "flash" discharge tube

Description	Light source (included)	Colour	Reference	Weight kg	
<b>Beacon comprising:</b> - 1 illuminated unit - 1 base unit	Integral "flash" discharge tube ~ 24 V	Green	XVD L6B3	0.480	
		Red	XVD L6B4	0.480	
		Orange	XVD L6B5	0.480	
		Blue	XVD L6B6	0.480	
		Clear	XVD L6B7	0.480	
		Yellow	XVD L6B8	0.480	
		Integral "flash" discharge tube ~ 230 V	Green	XVD L6M3	0.475
			Red	XVD L6M4	0.475
Orange	XVD L6M5		0.475		
Blue	XVD L6M6		0.475		
Clear	XVD L6M7		0.475		
Yellow	XVD L6M8		0.475		

(1) Incandescent bulbs and LEDs: see page 35096-EN\_Ver3.0/7.

# Beacons and indicator banks

Beacons and indicator banks Ø 70 mm  
Harmony type XVD Application  
Indicator banks Ø 70 mm for customer assembly  
(up to 5 units)

## Indicator banks for customer assembly of 1 to 5 signalling units

### Illuminated units with steady light signalling

Description	Light source, to be ordered separately (1)	Colour	Reference	Weight kg
Illuminated units	Incandescent bulb 10 W max., 250 V max. or LED	Green	XVD C33	0.115
		Red	XVD C34	0.115
		Orange	XVD C35	0.115
		Blue	XVD C36	0.115
		Clear	XVD C37	0.115
		Yellow	XVD C38	0.115



XVD C3●

### Illuminated units with integral flashing light signalling

Description	Light source, to be ordered separately (1)	Colour	Reference	Weight kg	
Illuminated units	Incandescent bulb 10 W max., ~ 24 V, ~ 24...48 V or LED	Green	XVD C4B3	0.135	
		Red	XVD C4B4	0.135	
		Orange	XVD C4B5	0.135	
		Blue	XVD C4B6	0.135	
		Clear	XVD C4B7	0.135	
		Yellow	XVD C4B8	0.135	
		Incandescent bulb 10 W max., ~ 48...230 V or LED	Green	XVD C4M3	0.135
			Red	XVD C4M4	0.135
Orange	XVD C4M5		0.135		
Blue	XVD C4M6		0.135		
Clear	XVD C4M7		0.135		
Yellow	XVD C4M8		0.135		



XVD C4●●

### Light diffuser

Description	For use with	Reference	Weight kg
Light diffuser clear plastic (Sold in boxes)	LED illuminated units only (all colours) One box allows to equip 5 illuminated units.	XVB Z18	0.080



XVB Z18

### Illuminated units with 5 Joule "flash" discharge tube

Description	Light source (included)	Colour	Reference	Weight kg	
Illuminated units	Integral "flash" discharge tube ~ 24 V	Green	XVD C6B3	0.310	
		Red	XVD C6B4	0.310	
		Orange	XVD C6B5	0.310	
		Blue	XVD C6B6	0.310	
		Clear	XVD C6B7	0.310	
		Yellow	XVD C6B8	0.310	
		Integral "flash" discharge tube ~ 230 V	Green	XVD C6M3	0.310
			Red	XVD C6M4	0.310
	Orange		XVD C6M5	0.310	
	Blue		XVD C6M6	0.310	
	Clear		XVD C6M7	0.310	
	Yellow		XVD C6M8	0.310	



XVD C6●●

(1) Incandescent bulbs and LEDs: see page 35096-EN\_Ver3.0/7.

## Beacons and indicator banks

Beacons and indicator banks Ø 70 mm  
Harmony type XVD Application  
Indicator banks Ø 70 mm for customer assembly  
(up to 5 units)



XVD C9e



XVD C07

### Indicator banks for customer assembly of 1 to 5 signalling units (continued)

#### Audible units

Description	Characteristics	Reference	Weight kg
Buzzer, 90 dB at 1 m adjustable, 70 to 90 dB, continuous or intermittent mode (using microswitches)	~ 12...48 V	XVD C9B	0.150
	~120...230 V	XVD C9M	0.150

#### Base units (for direct or support tube fixing)

Description	For use with	Type	Reference	Weight kg
Base unit + cover with bottom cable entry	Banks without "flash" discharge tube unit	Standard	XVD C21	0.180
Base unit only with bottom cable entry	Banks with "flash" discharge tube unit	Standard	XVD C07	0.160

#### Assembly screw

Screw for assembling signalling units on base unit	Banks without "flash" discharge tube unit	Type	Reference	Weight kg
		1 unit	XVD C03	0.015
	2 units	XVD C04	0.022	
	3 units	XVD C05	0.030	
	4 units	XVD C06	0.038	
	5 units	XVD C08	0.045	
	Banks with "flash" discharge tube unit	1 unit	XVD C09	0.036
		2 units	XVD C10	0.044
		3 units	XVD C11	0.050
		4 units	XVD C12	0.059



# Beacons and indicator banks

## Beacons and indicator banks Ø 70 mm

### Harmony type XVD Application

Accessories for customer assembled beacons and indicator banks



XVB Z02



XVB Z03/Z04



XVD C02



XVB C12



DL1 B●●



DL1 BD●●/DL1 BK●●

#### Accessories common to beacons and indicator banks

Description	Height under base unit (mm)	Support tube colour	Reference	Weight kg
Fixing bases comprising Ø 25 mm aluminium support tube glued into a black plastic fixing plate	80	Black aluminium	XVB Z02	0.110
		Aluminium	XVB Z02A	0.110
	380	Black aluminium	XVB Z03	0.200
		Aluminium	XVB Z03A	0.200
	780	Black aluminium	XVB Z04	0.325
		Aluminium	XVB Z04A	0.325

Description	Details	Colour	Reference	Weight kg
Fixing base (plastic support tube with integral fixing plate)	100 mm	Black	XVD C02	0.070
Fixing plate (Zamak) for use on vertical support	Direct mounting on base unit or using support tube with integral fixing plate XVD C02 or using fixing bases XVB Z0●			0.380
Cover only	-			0.020

Description	Characteristics	Sold in lots of	Unit reference	Weight kg
Incandescent bulbs BA 15d base fitting	12 V	10	DL1 B●J (1)	0.090
	24 V	10	DL1 B●B (1)	0.090
	48 V	10	DL1 B●E (1)	0.090
	120 V	10	DL1 B●G (1)	0.090
	230 V	10	DL1 B●M (1)	0.090

LEDs BA 15d base fitting	Voltage	Colour	Protected LED		Weight kg		
			Quantity	Reference			
~ 24 V		White	1	DL1 BDB1	0.015		
		Green	1	DL1 BDB3	0.015		
		Red	1	DL1 BDB4	0.015		
		Orange	1	DL1 BDB5	0.015		
		Blue	1	DL1 BDB6	0.015		
		Yellow	1	DL1 BDB8	0.015		
		~ 120 V		White	1	DL1 BDG1	0.015
				Green	1	DL1 BDG3	0.015
Red	1			DL1 BDG4	0.015		
Orange	1			DL1 BDG5	0.015		
Blue	1			DL1 BDG6	0.015		
Yellow	1			DL1 BDG8	0.015		
~ 230 V				White	1	DL1 BDM1	0.015
				Green	1	DL1 BDM3	0.015
		Red	1	DL1 BDM4	0.015		
		Orange	1	DL1 BDM5	0.015		
		Blue	1	DL1 BDM6	0.015		
		Yellow	1	DL1 BDM8	0.015		

Flashing LEDs BA 15d base fitting	Voltage	Colour	Protected LED		Weight kg
			Quantity	Reference	
~ 24 V		White	1	DL1 BKB1	0.015
		Green	1	DL1 BKB3	0.015
		Red	1	DL1 BKB4	0.015
		Orange	1	DL1 BKB5	0.015
		Blue	1	DL1 BKB6	0.015
		Yellow	1	DL1 BKB8	0.015
~ 120 V		White	1	DL1 BKG1	0.015
		Green	1	DL1 BKG3	0.015
		Red	1	DL1 BKG4	0.015
		Orange	1	DL1 BKG5	0.015
		Blue	1	DL1 BKG6	0.015
		Yellow	1	DL1 BKG8	0.015
~ 230 V		White	1	DL1 BKM1	0.015
		Green	1	DL1 BKM3	0.015
		Red	1	DL1 BKM4	0.015
		Orange	1	DL1 BKM5	0.015
		Blue	1	DL1 BKM6	0.015
		Yellow	1	DL1 BKM8	0.015

(1) Complete the reference using the letter "E" for a 7 W bulb or the letter "L" for a 10 W bulb. Example: DL1 BEJ.



# Beacons and indicator banks

Beacons and indicator banks Ø 70 mm  
Harmony type XVD Application  
Complete pre-cabled beacons and indicator banks  
and separate components for customer assembly

## Dimensions

### Complete pre-cabled beacons XVD B●6, XVD M●6

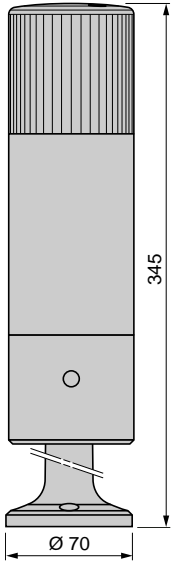

### Complete pre-cabled indicator banks XVD ●●●●

#### Without "flash" discharge tube

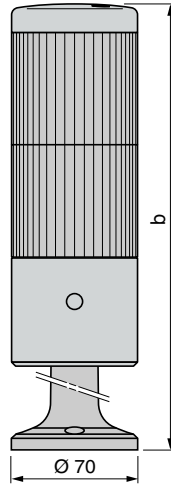

#### With "flash" discharge tube

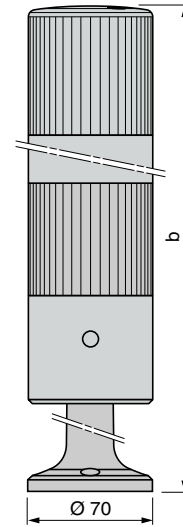

Number of illuminated or audible signalling units (no "flash")	b
2	302
3	365
4	428

Number of illuminated or audible signalling units other than "flash"	b
2	405
3	468

### Customer assembled beacons XVD L●●●

With steady or flashing light signalling, XVD L3●/L4●●

With "flash" discharge tube, XVD L6●●

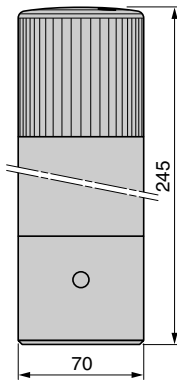
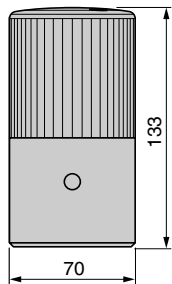

### Customer assembled indicator banks XVD C●●●

Without "flash" discharge tube

With "flash" discharge tube

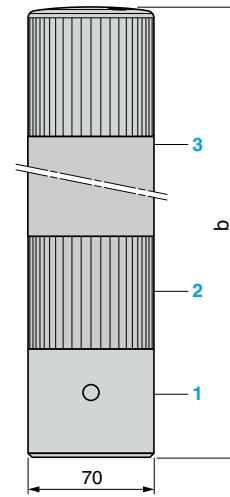
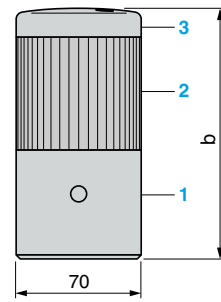

- 1 Base unit XVD C21 (1)
- 2 Illuminated unit XVD C3●/C4●● or audible unit XVD C9●
- 3 Cover (1)

- 1 Base unit XVD C07
- 2 Illuminated unit XVD C6●● or audible unit XVD C9●
- 3 "Flash" unit XVD C6●●

Number of illuminated or audible signalling units (no "flash")	b
1	140
2	203
3	266
4	329
5	392

Number of illuminated or audible signalling units other than "flash"	b
1	308
2	371
3	434
4	497

(1) Cover included with base unit XVD C21.

# Beacons and indicator banks

Beacons and indicator banks Ø 70 mm  
Harmony type XVD Application  
Complete pre-cabled beacons and indicator banks  
and separate components for customer assembly

## Mounting

With fixing bases XVB Z0● (aluminium support tube glued into black plastic fixing plate)

With fixing base XVD C02 (support tube with integral fixing plate)

Horizontal support panel cut-out for mounting on fixing plate

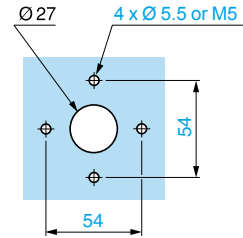
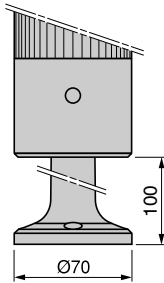
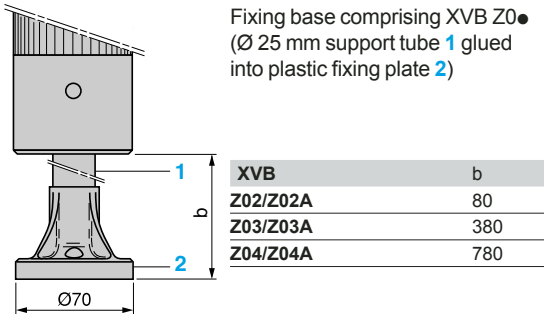

With fixing plate XVB C12 for use on vertical support  
Direct mounting on base unit

Mounting using fixing bases XVB Z0● or XVD C02

Vertical support panel drillings for fixing plate XVB C12

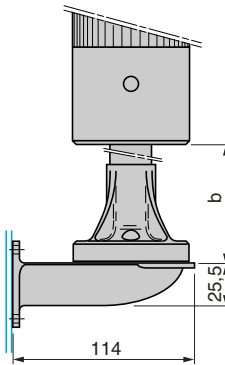
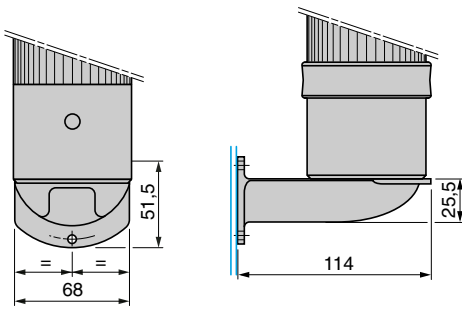

Fixing bases	b
XVB Z02/Z02A	80
XVB Z03/Z03A	380
XVB Z04/Z04A	780
XVD C02	100

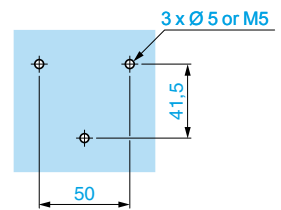

## Installation

### Connections

Complete pre-cabled beacons and indicator banks

Customer assembled beacons and indicator banks

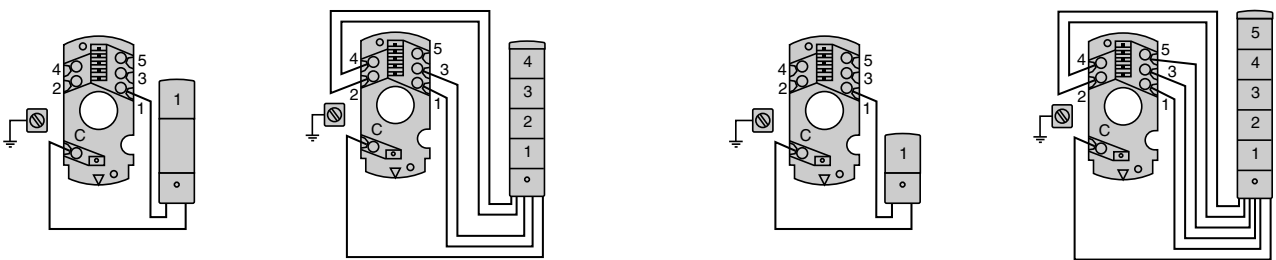

Wire colours of pre-assembled products:

- C: black
- 1: brown
- 2: grey
- 3: violet
- 4: blue

### Adjustment of audible signal for buzzers type XVD C9●

By 4 microswitches located in the base of the buzzer:

- 2 switches marked 1 and 2 for selecting continuous or intermittent mode (Hz).
- 2 switches marked 3 and 4 for selecting the audible signal power (dB).

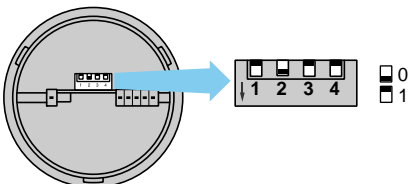

Position of microswitches				Setting	
1	2	3	4	Mode	Power
1	1	1	1	— 2.8 kHz	90 dB (Factory setting)
1	0	0	1	— 2.8 kHz	85 dB
0	1	1	0	⌋ 5 Hz (1)	80 dB
0	0	0	0	⌋ 1 Hz	70 dB