

Cooper Tools

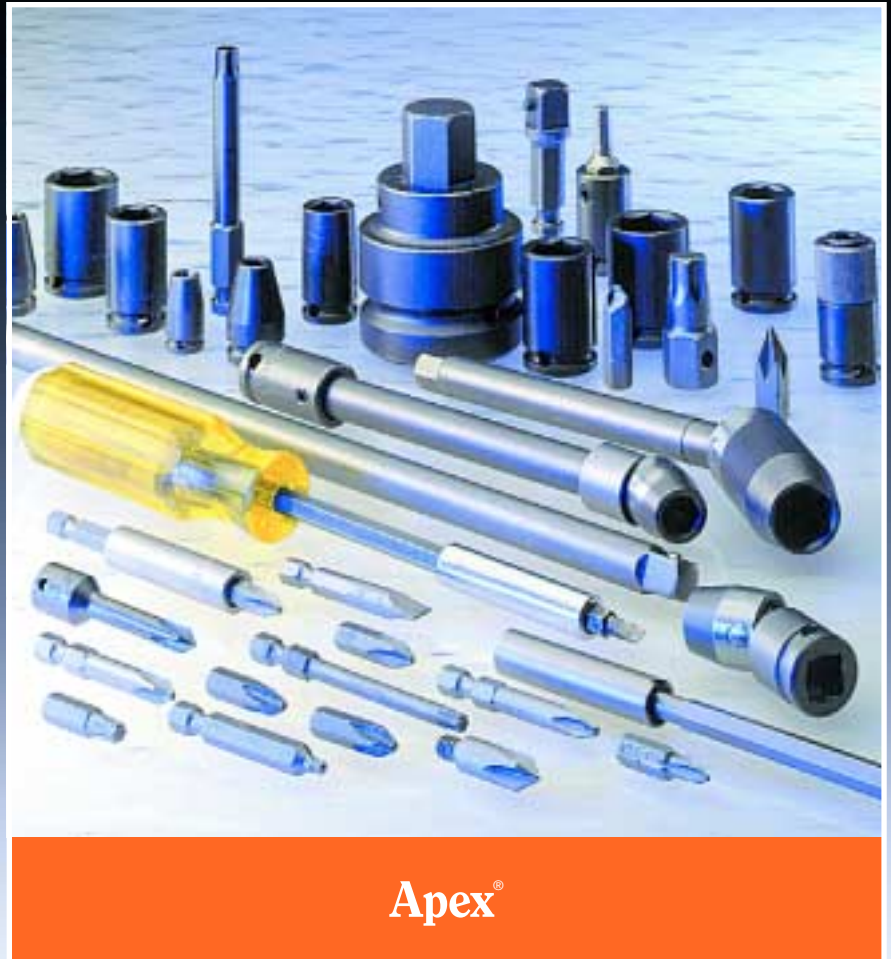

FASTENER TOOLS

COOPER Tools

Table of Contents



Introductioniv

Bits

Phillips	1
Slotted	11
Torx®	19
Torx Plus®	25
Pozidriv®	26
Sel-O-Fit®	29
Frearson	30
B.N.A.E.	31
Socket Head	32
Square Recess	41
Clutch Head	42
Pipe Plug Inserts	42
Torq-Set®	43
Tri-Wing®	46
Hi-Torque®	48
Triple Square	49

Bit Holders

Hex Drive	52
Female Square Drive	55

Hand Drivers

Replaceable Bit	57
Torx® Keys	58
Torx® and Torq-Set® Hand Drivers	59
Awls	59
Pivex™	59

Hex Drive Nutsetters, Extensions & Universal Wrenches

Nutsetters	60
Extensions	64
Universal Wrenches	68

1/4" Drive Sockets, Extensions, Adapters & Universal Wrenches

SAE Sockets and Universal Wrenches ..	77
Metric Sockets and Universal Wrenches	81
Spline and Torx® Sockets	83
Extensions and Adapters	85

3/8" Drive Sockets, Extensions, Adapters & Universal Wrenches

SAE Sockets & Universal Wrenches	86
Metric Sockets & Universal Wrenches ..	95
Spline & Torx® Sockets	102
Extensions & Adapters	103

1/2" Drive Sockets, Extensions, Adapters & Universal Wrenches

SAE Sockets & Universal Wrenches	105
Metric Sockets & Universal Wrenches ..	116
Spline & Torx® Sockets	125
Extensions & Adapters	126

5/8" Drive Sockets, Extensions, Adapters & Universal Wrenches

SAE Sockets, Universal Wrenches & Budd Wheel Sockets	128
Metric Sockets	131
Extensions & Adapters	131

3/4" Drive Sockets, Extensions, Adapters & Universal Wrenches

SAE Sockets, Universal Wrenches & Budd Wheel Sockets	133
Metric Sockets	137
Spline Sockets, Extensions & Adapters	138

1" Drive Sockets, Extensions & Adapters

SAE Sockets & Budd Wheel Sockets ...	140
Metric Sockets	144
Spline Sockets, Extensions & Adapters	145

1 1/2" Drive SAE Sockets & Adapters 147 |

2 1/2" Drive SAE Sockets & Adapters 148 |

Special Sockets, Adapters & Accessories

Reversible Sockets	151
Tap Holding Sockets	152
Grease Fitting Sockets	153
Drill Holders	154
#5 (1 5/8") Spline Drive Sockets, Extensions, Adapters,Registered Universal Wrenches & Budd Wheel Sockets	155
Socket Retaining Rings	156
Adapters	157
Part Number Index	161
Quotation Worksheets	169

Conversion Chart 172 |

Quick Reference



Bits 1 – 50



Bit Holders 51 – 56



Hand Drivers 57 – 59



Hex Drive Nutsetters, Extensions & Universal Wrenches 60 – 73



1/4" Sockets, Extensions, Adapters & Universal Wrenches 74 – 85



3/8" Sockets, Extensions, Adapters & Universal Wrenches 86 – 104



1/2" Sockets, Extensions, Adapters & Universal Wrenches 105 – 127



5/8"-2 1/2" Sockets, Extensions, Adapters & Universal Wrenches 128 – 148



Special Sockets, Adapters & Accessories 149 – 160

Part Number Index 161 – 168

The Apex heritage of quality, delivery and support.

For more than half a century...

Apex has maintained a position of leadership in industrial fastening tools. Today, Apex stands ready to improve the productivity of assembly operations around the world with unsurpassed tool performance and customer service. Here's how:

Highest Quality

Apex quality begins with select raw materials. Only carefully chosen, high grade tool steel is used. Each tool is precision machined from solid bar stock to close-tolerance standards. You get an exact, sure fit – a fit not possible from tools made in a process that grows less precise with every stamp. Finally, each tool is tempered with the exclusive Apex heat treating process that lets you select the degree of hardness you require. Choose from tough, non-brittle durability that stands up to torque, to the hardest heat treat available for the ultimate in wear resistance.



Rapid Select Means Fast Delivery



Models indicated with a **Rapid Select** icon represent our most popular tools, and are available for fast delivery on limited quantities. On bit items, the heat treat code has been added to Rapid Select part numbers. See page vi for selecting the proper heat treat.

Complete Support For Your Requirements

Apex provides the broadest selection of fastener tools in the world. From this catalog you can choose from over 5,000 individual items: from bits, sockets and hand drivers to universal wrenches, extensions and adapters. If the tool you need is not in this catalog, call your Apex representative. We may have what you need as a non-catalog item—or our experienced staff of tooling experts can design and produce application specific fastener tools to suit your needs.



Apex is the standard on assembly lines around the world.



Precision manufactured with the highest quality materials.



Responsive service for all your fastener tool needs.



Made in the U.S.A. since 1933.



User safety tips

- Always wear safety glasses when using any tool.
- Always visually inspect tool for damage and cracking. Immediately replace all damaged tools.
- Do not modify or alter any tool.
- Do not use tools beyond their limit or useful life.
- Contact Apex for the recommended operating torque of any tool.

Selecting the proper heat treat for bits

Choosing the proper heat treat for screwdriver tools is important in achieving long tool life. Different applications, different operators, and different power tools require different heat treats. Apex offers a choice of three heat treat hardness levels in many of our screwdriver bits to match the particular customer's application. These heat treats are specified by a letter suffix as follows:

X - The hardest heat treat available

I - Intermediate hardness

R - Lowest hardness

Selecting the heat treat best suited for a particular application may require some trial and error. The proper heat treat depends on the failure mode. If the bit breaks or shatters, select a bit with less hardness. If the failure mode is wear, select a harder bit. Many times both breakage and wear may occur within the same application. This can be due to a number of factors such as different operators, different torque values, and different power tool settings.

In general, high torque applications require "R" heat treats to withstand twisting and resist breakage. The "X" heat treat is most suitable for low torque applications, particularly if hardened screws are used.

If a failure occurs, a change in hardness may result in better service. The "X" heat treat is most common and should be selected unless the specifics of an application or an existing problem would suggest using "I" or "R" hardness.

To specify a particular heat treat, add a letter suffix to the part number. For example, to specify "X" hardness in a #2 Phillips insert, the part number would be 440-2X. Not all Apex bits are available in all heat treats. Special heat treats can be supplied for a particular application. Contact your Apex representative for specific recommendations.

Warning

- Using any adapter may result in a torque overload and failure in the adapter, socket or fastener.
- Do not use thin wall sockets with impact power tools.
- Do not use universal wrenches with impact power tools.

APEX® Solutions



What's the difference between an insert and a power bit?

Insert bits are commonly used with a bit holder in power tool applications. This combination is economical, provides flexibility and allows a fastener to be magnetically held by the bit. Power bits are placed directly into the power tool chuck. See pages 48-52 for a complete listing of Apex bit holders.



What's the advantage of reduced diameter bits?

Reduced diameter bits are ideal for driving screws below the surface of drywall.



What's the advantage of 27 Series bits?

27 Series bits are ideal for poorly recessed Phillips screws. A wider tip design fills out an inexact recess to make better contact.



Why do Apex bits last so much longer?

Apex's premium tool alloys and proprietary heat treat help avoid typical problems

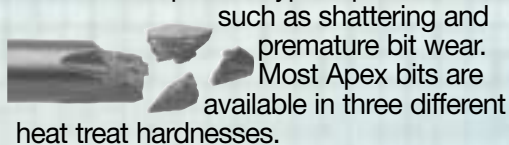

such as shattering and premature bit wear. Most Apex bits are available in three different heat treat hardnesses.

Refer to page vi for information on selecting the proper heat treat.

What's the advantage of Apex® ACR® bits?

Painted, coated or corroded fasteners can present special problems. Apex® ACR® insert bits' special wing-face ribs grip screw recesses to reduce stripping and cam-out which can result in damage to the surrounding workpiece. Choose from bits ribbed for screw removal, driving or both. They're also available in both insert bits and power drives.

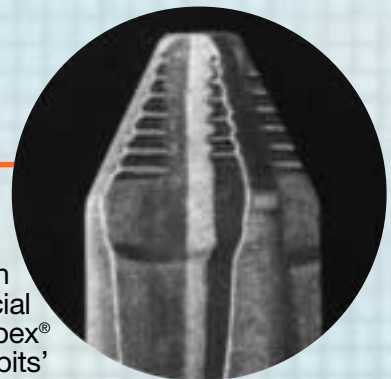

In this section...

Insert and Power Drive Bits



For all these fastener styles:

Phillips®		Sel-o-fit®		Clutch Head	
Slotted		Frearson		Torq-Set®	
Torx®		B.N.A.E.		Tri-Wing®	
Torx Plus®		Socket Head		Hi-Torque®	
Pozidriv®		Square Recess		Triple Square	

Bit Holders, Nutsetters, Extensions and Universal Wrenches



Bit holders adapt hex drive and female square drive power tools to a variety of insert bits. Hex drive nutsetters, extensions and universal wrenches allow nutrunning in all types of applications.

Selecting the correct Phillips point size











Apex bits in these five point sizes will drive ANY Phillips screw

Point Size	Wood Screws			Machine Screws			Sheet Metal Screws Flat, Round, Oval, Stove, Binding
	Body Dia.	Flat, Oval	Round	Flat, Oval, Binding	Round, Fillister	Truss, Brazier, Button	
0	0	0	0	0	0	0	
1	3/16	2	2	2	2	2	2
	3	3	3	3	3	3	
	4	4	4	4	4	4	
2	1/4	5	5	5	5	5	5
	6	6	6	6	8	6	
	7	7	8	8	10	7	
	8	8	10	10	8		
3	9	9	10				
	10						
	5/16	10	12	12	12	12	12
	12	14	1/4	1/4	1/4	14	
4	14	16	5/16				
	16						
	3/8	18	18	5/16	3/8	5/16	
	20	20	3/8	7/16	3/8		
	24	24	7/16	1/2	7/16		
	1/2	1/2					

IMPORTANT The table above will enable you to determine the Phillips point size required for any Phillips screws or bolts. The No. 2 and No. 3 point sizes cover the range of Phillips screws most commonly used. The Apex Phillips bits on the following pages are available in point sizes to drive any Phillips screw.

1/4" Hex Insert Bits





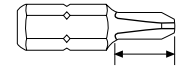

Part Number	Point Size	Overall Length		
		In.	mm	
440-1X 	1	1	25	
440-115	1	1 1/2	38	
440-12	1	2	51	
440-125	1	2 1/2	64	
440-13	1	3	76	
440-2X 	2	1	25	
440-2I 	2	1	25	
440-27*	2	1	25	For shallow screw recesses
440-215X 	2	1 1/2	38	
440-22X 	2	2	51	
440-225X 	2	2 1/2	64	
440-23	2	3	76	
440-24	2	4	101	
440-255	2	5 1/2	140	
440-26	2	6	152	
440-3X 	3	1	25	
440-3I 	3	1	25	
440-3125	3	1 1/4	32	
440-3BN 	3	1 1/4	32	Large body
440-32	3	2	51	
440-325	3	2 1/2	64	
440-33	3	3	76	
440-34	3	4	101	
440-4 	4	1 5/16	33	

*For shallow screw recesses. See Tool Tip on page 7

1/4" Hex Insert Bits – Limited Clearance



Part Number	Point Size	Overall Length		Turned Length	
		In.	mm	In.	mm
446-0	0	1	25	7/16	11
446-1X 	1	1	25	7/16	11
446-12	1	2	51	7/16	11
SD-1055-A	1	2	51	1 3/8	35
446-2X 	2	1	25	7/16	11
446-2I 	2	1	25	7/16	11
446-27*	2	1	25	7/16	11
446-215	2	1 1/2	38	7/16	11
446-22	2	2	51	7/16	11
446-215T 	2	1 1/2	38	1	25
446-22T 	2	2	51	1 1/2	38
446-225T	2	2 1/2	64	1 3/4	44
446-23T	2	3	76	2 1/4	57

* For shallow screw recesses see Tool Tip on page 7.

1/4" Hex Insert Bits – ACR®



Part number suffix -R
For removal







Part number suffix -D
For driving



No part number suffix
For both removal and driving







Part Number	Point Size	Overall Length		Limited Clearance
		In.	mm	
440-1-ACR1-R	1	1	25	
440-1-ACR1-D	1	1	25	
440-1-ACR1	1	1	25	
440-2-ACR2-RX 	2	1	25	
440-2-ACR2-RI 	2	1	25	
440-2-ACR2-D	2	1	25	
440-2-ACR2X 	2	1	25	
446-2-ACR2-D	2	1	25	Limited Clearance
440-22-ACR2-R	2	2	51	
440-22-ACR2-D	2	2	51	
440-22-ACR2	2	2	51	
440-3-ACR3-RX 	3	1	25	
440-3-ACR3-D	3	1	25	
440-3-ACR3	3	1	25	

ACR® is a trademark of the Phillips Screw Co.

 Refer to Page iv for description of Rapid Select. Rapid Select bit part numbers have the heat treat code noted.

5/16" Hex Insert Bits



Part Number	Point Size	Overall Length		
		In.	mm	
480-1	1	1 1/4	32	
480-2X 	2	1 1/4	32	
480-27*	2	1 1/4	32	For shallow screw recesses
480-22	2	2	51	
480-225	2	2 1/2	64	
480-24	2	4	101	
480-3X 	3	1 1/4	32	
480-325	3	2 1/2	64	
480-34	3	4	101	
480-4X 	4	1 1/4	32	
480-4BNX 	4	1 1/2	38	Large body
480-425	4	2 1/2	64	

* For shallow screw recesses see Tool Tip on page 7.

5/16" Hex Insert Bits – ACR®



Part number suffix -R
For removal



Part number suffix -D
For driving



No part number suffix
For both removal
and driving



Part Number	Point Size	Overall Length		
		In.	mm	
480-2-ACR2-R	2	1 1/4	32	
480-2-ACR2-D	2	1 1/4	32	
480-2-ACR2X 	2	1 1/4	32	
480-3-ACR3-R	3	1 1/4	32	
480-3-ACR3-D	3	1 1/4	32	
480-3-ACR3	3	1 1/4	32	
480-4-ACR4-R	4	1 1/4	32	
480-4-ACR4-D	4	1 1/4	32	
480-4-ACR4	4	1 1/4	32	





















5/16" Square Insert Bits



Part Number	Point Size	Overall Length		
		In.	mm	
830-1	1	1 1/8	29	
830-2X 	2	1 1/8	29	
830-27	2	1 1/8	29	For shallow screw recesses*
830-3	3	1 1/8	29	
830-4	4	1 1/8	29	

1/4" Hex Power Drive



Part Number	Point Size	Overall Length		Body Diameter		Turned Length	
		In.	mm	In.	mm	In.	mm
4910X 	0	1 15/16	49	1/8	3.2	1 1/4	32
4910-A	0	2 3/4	70	1/8	3.2	2	51
4910-BX 	0	3 1/2	89	1/8	3.2	2 3/4	70
4910-C	0	6	152	1/8	3.2	2	51
491X 	1	1 15/16	49	3/16	4.8	1 1/4	32
491-AX 	1	2 3/4	70	3/16	4.8	2	51
491-BX 	1	3 1/2	89	3/16	4.8	2 3/4	70
491-CX 	1	6	152	3/16	4.8	2	51
491-CCX 	1	6	152	3/16	4.8	5 1/4	133
492X 	2	1 15/16	49	1/4	6.4	1 1/4	32
492I 	2	1 15/16	49	1/4	6.4	1 1/4	32
492-AX 	2	2 3/4	70	1/4	6.4	2	51
492-AI 	2	2 3/4	70	1/4	6.4	2	51
492-BX 	2	3 1/2	89	1/4	6.4	2 3/4	70
492-BI 	2	3 1/2	89	1/4	6.4	2 3/4	70
492-CX 	2	6	152	1/4	6.4	2	51
492-CI 	2	6	152	1/4	6.4	2	51
492-CCX 	2	6	152	1/4	6.4	5 1/4	133
492-27*	2	1 15/16	49	1/4	6.4	1 1/4	32
492-A-27*	2	2 3/4	70	1/4	6.4	2	51
492-B-27*	2	3 1/2	89	1/4	6.4	2 3/4	70
492-C-27*	2	6	152	1/4	6.4	2	51
492-CC-27*	2	6	152	1/4	6.4	5 1/4	133
492-200MM	2	7 13/16	200	1/4	6.4	7	178
SD-2052-8	2	8	203	9/32	7.1	7	178
SD-2052-10	2	10	254	9/32	7.1	9	229
493X 	3	1 15/16	49	5/16	7.9	1	25
493-AX 	3	2 3/4	70	5/16	7.9	1 3/4	44
493-BX 	3	3 1/2	89	5/16	7.9	2 1/2	64
493-CX 	3	6	152	5/16	7.9	5	127
4930	3	1 15/16	49	1/4	6.4	1 1/4	32
4930-A	3	2 3/4	70	1/4	6.4	2	51
4930-B	3	3 1/2	89	1/4	6.4	2 3/4	70
4930-C	3	6	152	1/4	6.4	2	51
4930-CC	3	6	152	1/4	6.4	5 1/4	133
494	4	1 15/16	49	3/8	9.5	1	25





* For shallow screw recesses. See Tool Tip on page 7.

Phillips Bits

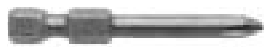
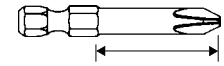

1/4" Hex Power Drive – ACR®



Part Number	Point Size	Overall Length		Body Diameter		Turned Length	
		In.	mm	In.	mm	In.	mm
491-ACR1-R	1	1 15/16	49	3/16	4.8	1 1/4	32
491-ACR1-D	1	1 15/16	49	3/16	4.8	1 1/4	32
491-ACR1	1	1 15/16	49	3/16	4.8	1 1/4	32
492-ACR2-R	2	1 15/16	49	1/4	6.4	1 1/4	32
492-ACR2-D	2	1 15/16	49	1/4	6.4	1 1/4	32
492-ACR2X 	2	1 15/16	49	1/4	6.4	1 1/4	32
492-A-ACR2-R	2	2 3/4	70	1/4	6.4	2	51
492-A-ACR2-D	2	2 3/4	70	1/4	6.4	2	51
492-A-ACR2X 	2	2 3/4	70	1/4	6.4	2	51
492-B-ACR2-R	2	3 1/2	89	1/4	6.4	2 3/4	70
492-B-ACR2-D	2	3 1/2	89	1/4	6.4	2 3/4	70
492-B-ACR2X 	2	3 1/2	89	1/4	6.4	2 3/4	70
492-C-ACR2-D	2	6	152	1/4	6.4	2	51
493-ACR3-R	3	1 15/16	49	5/16	7.9	1	25
493-ACR3-D	3	1 15/16	49	5/16	7.9	1	25
493-ACR3X 	3	1 15/16	49	5/16	7.9	1	25

Part number suffix -R
For removal (diagram)



Part number suffix -D
For driving (diagram)



No part number suffix
For both removal and driving (diagram)





1/4" Hex Power Drive with Finder Sleeve

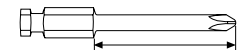

Part Number	Point Size	Overall Length	Sleeve Diameter
		In. mm	In. mm
SD-556-A 	2	3 1/2 89	7/16 11.1
SD-556	2	6 152	7/16 11.1

7/16" Hex Power Drive



Part Number	Point Size	Overall Length		Body Diameter		Turned Length	
		In.	mm	In.	mm	In.	mm
482	2	3 1/2	89	1/4	6.4	2 1/4	57
483X 	3	3 1/2	89	5/16	7.9	2 1/4	57
484	4	3 1/2	89	3/8	9.5	2 1/4	57

ACR® is a trademark of the Phillips Screw Co.

 Refer to Page iv for description of Rapid Select. Rapid Select bit part numbers have the heat treat code noted.



9/32" No. 130A Yankee Drive



Part Number	Point Size	Overall Length		Body Diameter	
		In.	mm	In.	mm
451	1	3 1/4	83	3/16	4.8
452	2	3 1/4	83	9/32	7.1
453	3	3 1/4	83	5/16	7.9
454	4	3 1/4	83	3/8	9.5

10-32 Screw Shank Drive





Part Number	Point Size	Overall Length		Body Diameter	
		In.	mm	In.	mm
501	1	1 1/2	38	3/16	4.8
501-A	1	1 13/16	46	3/16	4.8
502X 	2	1 1/2	38	1/4	6.4
502-ACR2*	2	1 1/2	38	1/4	6.4
SD-1342-2 	2	1 3/4	45	1/4	6.4
502-A	2	1 13/16	46	1/4	6.4
503	3	1 1/2	38	5/16	7.9

*Features ACR® anti-camout ribs. See Tool Tip on page 3.

12-24 Screw Shank Drive



Part Number	Point Size	Overall Length		Body Diameter	
		In.	mm	In.	mm
551	1	1 3/16	30	.30	7.6
552X 	2	1 3/16	30	.30	7.6
552I 	2	1 3/16	30	.30	7.6
553	3	1 3/16	30	.30	7.6

1/4"-24 Screw Shank Drive



Part Number	Point Size	Overall Length		Body Diameter	
		In.	mm	In.	mm
401	1	1 1/2	38	3/16	4.8
402X 	2	1 1/2	38	1/4	6.4
403	3	1 1/2	38	5/16	7.9

Phillips Bits



8-32 Screw Shank Drive





Part Number	Point Size	Overall Length		Body Diameter	
		In.	mm	In.	mm
591	1	1 3/16	30	7/32	5.6
592X 	2	1 3/16	30	7/32	5.6
592-27*	3	1 3/16	30	7/32	5.6

* For shallow screw recesses.

Female Square Service Drive



Part Number	Female Square Drive	Point Size	Overall Length		Body Diameter	
			In.	mm	In.	mm
821	1/4	1	2	51	1/4	6.4
822	1/4	2	2	51	1/4	6.4
832 	3/8	2	2 5/8	67	5/16	7.9
833 	3/8	3	2 5/8	67	5/16	7.9
834	3/8	4	2 5/8	67	5/16	7.9
852	1/2	2	2 7/8	73	5/16	7.9
853	1/2	3	2 7/8	73	5/16	7.9
854 	1/2	4	2 7/8	73	3/8	9.5

Fein Drive



Part Number	Point Size	Length	
		In.	mm
FND-1PH	1	2	53
FND-2PH	2	2	53
FND-2PH-70M	2	2 3/4	70
FND-3PH	3	2	53

APEX® Solutions

Does Apex offer Torx® bits?

Torx® fasteners are becoming more and more common in automotive and appliance assembly. Apex provides a full selection of bits for Torx screws.

(See pages 19–25)

Torx® is a trademark of the Camcar Division of Textron.



Is there an easy way to select a bit?

Take the guesswork out of bit selection. Apex Phillips and Torx® ring gauges help you find the right bit for your fasteners.

Order SD-3749 for Phillips and SD-4064-G for Torx®.



What is a finder sleeve?

A finder sleeve makes it easy to engage slotted fasteners with the bit. It guides the bit so there is less "searching" for the proper alignment between blade and slot.



(See page 16)

Why do Apex bits last so much longer than other bits?

Apex's premium tool alloys and proprietary heat treat help avoid typical problems such as shattering and premature bit wear. Most Apex bits are available in three different heat treat hardnesses.

Refer to page vi for information on selecting the proper heat treat.



What's the difference between Torx® and Torx Plus® bits?

Torx Plus® bits and fasteners feature a greater engagement area for higher torque transfer and reduced camout when driving Torx Plus® fasteners. They can provide up to 100% more drive cycles. Torx Plus® bits are not compatible with standard Torx® fasteners.

(See pages 19-25)



Torx Plus® is a trademark of the Camcar Division of Textron. Torx Plus® Tamper Resistant Bits are available on a limited basis. Please contact your Area Distributor or Representative for more details.

Does Apex offer fastener tools for the aircraft industry?

Apex offers a full selection of fastener tools common to aircraft assembly and maintenance, including Tri-Wing®, Torq-Set®, Hi-Torque® and Phillips.

(See pages 43-48)



Torq-Set® and ACR® are registered trademarks of the Phillips Screw Company.

Does Apex offer mar resistant bits and sockets?

Apex can nylon coat just about any of our bits or sockets. Nylon offers excellent mar resistance for assemblies that have painted, varnished or chromed surfaces. Nylon also offers some safety benefits by covering tool junctions. Contact your Apex distributor or representative for more information or for a quote.



How do Torxalign® bits work?

Torxalign® bits “wedge” into the Torx® recess to firmly hold the fastener to the bit.



(See pages 19-24)

What's the difference between a Phillips and a Pozidriv® screw?

The shallow “cross” indentation in the screw head identifies a Pozidriv® fastener. The Pozidriv® bit and recess design provides contact than a standard Phillips for more torque with less possibility of camout.



(See pages 26 & 27)

Slotted Screw Sizes



Types of Heads

Note: When ordering slotted bits, please remember that head sizes and slot widths of hardened, self tapping, and sheet metal screws do not conform to the same specifications as standard wood or machine screws described in the chart below. Also, because of variations in these dimensions among screws from different manufacturers, bits should be ordered to head and slot size rather than screw size.



Screw Sizes	Diameter of Head									
	Flat Head Oval Head		Round Head		Truss Head	Binding Head	Fillister Cap		Pan Head	Width of slot
	Wood	Mach.	Wood	Mach.			Cap	Mach.		
1	.146	.146	.138	.138				.118		.026
	.130	.130	.122	.122				.104		.019
2	.172	.172	.162	.162	.194	.181		.140	.167	.031
	.156	.156	.146	.146	.180	.171		.124	.155	.023
3	.199	.199	.187	.187	.226	.208		.161	.193	.035
	.181	.181	.169	.169	.211	.197		.145	.180	.027
4	.225	.225	.211	.211	.257	.235		.183	.219	.039
	.207	.207	.193	.193	.241	.223		.166	.205	.031
5	.252	.252	.236	.236	.289	.263		.205	.245	.043
	.232	.232	.217	.217	.272	.249		.187	.231	.035
6	.279	.279	.260	.260	.321	.290		.226	.270	.048
	.257	.257	.240	.240	.303	.275		.208	.256	.039
7	.305		.285		.352				.296	.048
	.283		.264		.333				.281	.039
8	.332	.332	.309	.309	.384	.344		.270	.322	.054
	.308	.308	.287	.287	.364	.326		.250	.306	.045
9	.358		.334							.054
	.334		.311							.045
10	.385	.385	.359	.359	.448	.339		.313	.373	.060
		.359	.334	.334	.425	.378		.292	.357	.050
12	.438	.438	.408	.408	.511	.454		.357	.425	.067
	.410	.410	.382	.382	.487	.430		.334	.407	.056
14	.491		.457							.075
	.461		.424							.064
1/4"		.507		.472	.573	.513	.375	.414	.492	.075
		.477		.443	.546	.488	.363	.389	.473	.064
16	.544		.506							.075
	.512		.476							.064
18	.597		.555							.084
	.563		.523							.072
5/16"		.635		.590	.698	.641	.437	.518	.615	.084
		.600		.557	.666	.609	.424	.490	.594	.072
20	.650		.604							.084
	.614		.570							.072
24	.756		.702							.094
	.716		.664							.081
3/8"		.762		.708	.823	.769	.562	.622	.740	.094
		.722		.670	.787	.731	.547	.590	.716	.081

Slotted Bits







1/4" Hex Insert Bits – Limited Clearance



Part Number	Screw Size	Length		Blade Thickness		Blade Width	
		In.	mm	In.	mm	In.	mm
445-000	1F-2R	1	25	.021	.53	.125	3.2
445-00	2F-3R	1	25	.025	.64	.140	3.6
445-0X 	3F-4R	1	25	.030	.76	.154	3.9
445-10X 	4F-5R	1	25	.034	.86	.185	4.7
445-20	5F-6R	1	25	.036	.91	.216	5.5
445-30	6F-7R	1	25	.038	.97	.248	6.3
445-00-15	2F-3R	1 1/2	38	.028	.71	.138	3.5
445-0-15	3F-4R	1 1/2	38	.032	.81	.154	3.9
445-10-15	4F-5R	1 1/2	38	.034	.86	.185	4.7
445-20-15	5F-6R	1 1/2	38	.036	.91	.216	5.5
445-30-15	6F-7R	1 1/2	38	.038	.97	.248	6.3

1/4" Hex Insert Bits



Part Number	Screw Size	Length		Blade Thickness		Blade Width	
		In.	mm	In.	mm	In.	mm
445-1X 	4F-5R	1	25	.034	.86	3/16	4.8
445-2X 	6F-8R	1	25	.040	1.02	7/32	5.6
445-3X 	8F-10R	1	25	.042	1.07	1/4	6.4
445-4X 	10F-12R	1	25	.046	1.17	9/32	7.1
445-1-15	4F-5R	1 1/2	38	.034	.86	3/16	4.8
445-2-15	6F-8R	1 1/2	38	.040	1.02	7/32	5.6
445-3-15	8F-10R	1 1/2	38	.042	1.07	1/4	6.4
445-4-15	10F-12R	1 1/2	38	.046	1.17	9/32	7.1
445-5X 	12F-14R	1 1/2	38	.050	1.27	5/16	7.9
445-6	14F-16R	1 1/2	38	.055	1.40	23/64	9.1

5/16" Hex Insert Bits



Part Number	Screw Size	Length		Blade Thickness		Blade Width	
		In.	mm	In.	mm	In.	mm
485-1	4F-5R	1 1/2	38	.034	.86	3/16	4.8
485-2	6F-8R	1 1/2	38	.040	1.02	7/32	5.6
485-3	8F-10R	1 1/2	38	.042	1.07	1/4	6.4
485-4	10F-12R	1 1/2	38	.046	1.17	.296	7.52
485-5	12F-14R	1 1/2	38	.050	1.27	.328	8.33
485-6	14F-16R	1 1/2	38	.055	1.40	.328	8.33
485-7X 	16F-18R	1 3/4	45	.060	1.52	1/2	12.7

1/4" Hex Power Drive

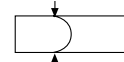

Part Number	Screw Size	Length		Blade Thickness		Blade Width/ Body Diameter	
		In.	mm	In.	mm	In.	mm
320-000	1F-2R	1 15/16	49	.022	.56	.122	3.10
326-000	1F-2R	2 3/4	70	.022	.56	.122	3.10
323-000	1F-2R	3	76	.022	.56	.122	3.10
327-000	1F-2R	3 1/2	89	.022	.56	.122	3.10
324-000	1F-2R	4	102	.022	.56	.122	3.10
325-000	1F-2R	5	127	.022	.56	.122	3.10
328-000	1F-2R	6	152	.022	.56	.122	3.10
320-00	2F-3R	1 15/16	49	.026	.66	.134	3.40
326-00	2F-3R	2 3/4	70	.026	.66	.134	3.40
323-00	2F-3R	3	76	.026	.66	.134	3.40
327-00	2F-3R	3 1/2	89	.026	.66	.134	3.40
324-00	2F-3R	4	102	.026	.66	.134	3.40
325-00	2F-3R	5	127	.026	.66	.134	3.40
328-00	2F-3R	6	152	.026	.66	.134	3.40
320-0	3F-4R	1 15/16	49	.030	.76	.151	3.84
326-0	3F-4R	2 3/4	70	.030	.76	.151	3.84
323-0	3F-4R	3	76	.030	.76	.151	3.84
327-0	3F-4R	3 1/2	89	.030	.76	.151	3.84
324-0	3F-4R	4	102	.030	.76	.151	3.84
325-0	3F-4R	5	127	.030	.76	.151	3.84
328-0	3F-4R	6	152	.030	.76	.151	3.84
320-1X 	4F-5R	1 15/16	49	.034	.86	.187	4.75
326-1	4F-5R	2 3/4	70	.034	.86	.187	4.75
323-1	4F-5R	3	76	.034	.86	.187	4.75
327-1	4F-5R	3 1/2	89	.034	.86	.187	4.75
324-1	4F-5R	4	102	.034	.86	.187	4.75
325-1	4F-5R	5	127	.034	.86	.187	4.75





(continued on next page)

Slotted Bits

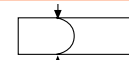

1/4" Hex Power Drive (continued)



Part Number	Screw Size	Length		Blade Thickness		Blade Width/ Body Diameter	
		In.	mm	In.	mm	In.	mm
328-1	4F-5R	6	152	.034	.86	.187	4.75
320-20	5F-6R	1 15/16	49	.036	.91	.215	5.46
326-20	5F-6R	2 3/4	70	.036	.91	.215	5.46
323-20	5F-6R	3	76	.036	.91	.215	5.46
327-20	5F-6R	3 1/2	89	.036	.91	.215	5.46
324-20	5F-6R	4	102	.036	.91	.215	5.46
325-20	5F-6R	5	127	.036	.91	.215	5.46
328-20	5F-6R	6	152	.036	.91	.215	5.46
320-2X 	5F-6R	1 15/16	49	.036	.91	.250	6.35
326-2	5F-6R	2 3/4	70	.036	.91	.250	6.35
323-2	5F-6R	3	76	.036	.91	.250	6.35
327-2	5F-6R	3 1/2	89	.036	.91	.250	6.35
324-2	5F-6R	4	102	.036	.91	.250	6.35
325-2	5F-6R	5	127	.036	.91	.250	6.35
328-2	5F-6R	6	152	.036	.91	.250	6.35
320-3X 	6F-8R	1 15/16	49	.038	.97	.250	6.35
326-3	6F-8R	2 3/4	70	.038	.97	.250	6.35
323-3	6F-8R	3	76	.038	.97	.250	6.35
327-3	6F-8R	3 1/2	89	.038	.97	.250	6.35
324-3	6F-8R	4	102	.038	.97	.250	6.35
325-3	6F-8R	5	127	.038	.97	.250	6.35
328-3	6F-8R	6	152	.038	.97	.250	6.35
320-4X 	8F-10R	1 15/16	49	.042	1.07	.275	6.99
326-4	8F-10R	2 3/4	70	.042	1.07	.275	6.99
323-4	8F-10R	3	76	.042	1.07	.275	6.99
327-4	8F-10R	3 1/2	89	.042	1.07	.275	6.99
324-4	8F-10R	4	102	.042	1.07	.275	6.99
325-4	8F-10R	5	127	.042	1.07	.275	6.99
328-4	8F-10R	6	152	.042	1.07	.275	6.99
320-5X 	10F-12R	1 15/16	49	.046	1.17	.312	7.92
326-5	10F-12R	2 3/4	70	.046	1.17	.312	7.92
323-5	10F-12R	3	76	.046	1.17	.312	7.92
327-5	10F-12R	3 1/2	89	.046	1.17	.312	7.92
324-5	10F-12R	4	102	.046	1.17	.312	7.92
325-5	10F-12R	5	127	.046	1.17	.312	7.92
328-5	10F-12R	6	152	.046	1.17	.312	7.92
320-6	12F-14R	1 15/16	49	.050	1.27	.360	9.14
326-6	12F-14R	2 3/4	70	.050	1.27	.360	9.14
323-6	12F-14R	3	76	.050	1.27	.360	9.14
327-6	12F-14R	3 1/2	89	.050	1.27	.360	9.14
324-6	12F-14R	4	102	.050	1.27	.360	9.14
325-6	12F-14R	5	127	.050	1.27	.360	9.14
328-6	12F-14R	6	152	.050	1.27	.360	9.14

Slotted Bits



5/16" Hex Power Drive

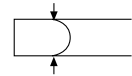

Part Number	Screw Size	Length		Blade Thickness		Blade Width/ Body Diameter	
		In.	mm	In.	mm	In.	mm
635-3	5F-6R	2 1/4	57	.036	.91	.250	6.35
635-4	6F-8R	2 1/4	57	.038	.97	.275	6.99
635-5	8F-10R	2 1/4	57	.042	1.07	.312	7.92
635-6	10F-12R	2 1/4	57	.046	1.17	.360	9.14
635-7	12F-14R	2 1/4	57	.050	1.27	.395	10.03
635-8	14F-16R	2 1/4	57	.055	1.40	.457	11.61
635-9	16F-20R	2 1/4	57	.060	1.52	.503	12.78
635-10	20F-22R	2 1/4	57	.062	1.57	.545	13.84

10-32 Screw Shank Drive

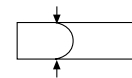

Part Number	Screw Size	Length		Blade Thickness		Blade Width/ Body Diameter	
		In.	mm	In.	mm	In.	mm
103-000	1F-2R	1 1/2	38	.022	.56	.125	3.18
103-00	2F-3R	1 1/2	38	.026	.66	.140	3.56
103-0	3F-4R	1 1/2	38	.030	.76	.156	3.96
103-1	4F-5R	1 1/2	38	.034	.86	.187	4.75
103-2	5F-6R	1 1/2	38	.036	.91	.225	5.72
103-3	6F-7R	1 1/2	38	.038	.97	.250	6.35
103-4	7F-8R	1 1/2	38	.040	1.02	.275	7.24
103-5	8F-10R	1 1/2	38	.042	1.07	.296	7.52
103-6	10F-12R	1 1/2	38	.046	1.17	.309	7.85

Slotted Bits



12-24 Screw Shank Drive

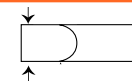

Part Number	Screw Size	Length		Blade Thickness		Blade Width	
		In.	mm	In.	mm	In.	mm
260-1	2F-3R	1 3/16	30	.026	.66	.171	4.3
260-2	3F-4R	1 3/16	30	.030	.76	.191	4.7
260-3	4F-5R	1 3/16	30	.034	.86	.212	5.4
260-4	5F-6R	1 3/16	30	.036	.91	.238	6.0
260-5	6F-7R	1 3/16	30	.038	.97	.261	6.6
260-7	8F-10R	1 3/16	30	.042	1.07	.309	7.8
260-8	10F-12R	1 3/16	30	.046	1.17	.309	7.8
260-9	12F-14R	1 3/16	30	.050	1.27	.309	7.8

1/4"-24 Screw Shank Drive

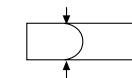

Part Number	Screw Size	Length		Blade Thickness		Blade Width/ Body Diameter	
		In.	mm	In.	mm	In.	mm
309-000	1F-2R	1 1/2	38	.022	.56	.125	3.18
309-00	2F-3R	1 1/2	38	.026	.66	.140	3.56
309-0	3F-4R	1 1/2	38	.030	.76	.156	3.96
309-1	4F-5R	1 1/2	38	.034	.86	.187	4.75
309-2	5F-6R	1 1/2	38	.036	.91	.225	5.72
309-3	6F-7R	1 1/2	38	.038	.97	.250	6.35
309-4	7F-8R	1 1/2	38	.040	1.02	.285	7.24
309-5	8F-10R	1 1/2	38	.042	1.07	.296	7.52
309-6	10F-12R	1 1/2	38	.046	1.17	.315	8.00
309-7	12F-14R	1 1/2	38	.050	1.27	.361	9.17
309-8	14F-16R	1 1/2	38	.055	1.40	.361	9.17

9/32" No. 130A Yankee Drive

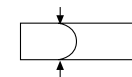





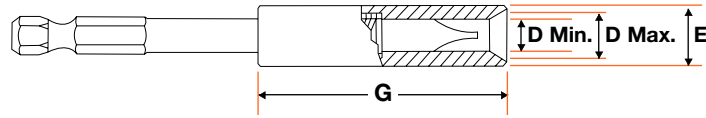

Part Number	Screw Size	Length		Blade Thickness		Blade Width/ Body Diameter	
		In.	mm	In.	mm	In.	mm
130-3	3F-4R	3 1/4	83	.030	.76	.156	3.96
130-4	4F-5R	3 1/4	83	.034	.86	.187	4.75
130-5	5F-6R	3 1/4	83	.036	.91	.225	5.72
130-6	6F-7R	3 1/4	83	.038	.97	.250	6.35
130-7	7F-8R	3 1/4	83	.040	1.02	.285	7.24
130-8	8F-10R	3 1/4	83	.042	1.07	.315	8.00

1/4" Power Drive with Finder Sleeves

Each finder sleeve assembly part number begins with a letter prefix that denotes the particular sleeve used with that assembly. The chart below gives complete dimensional data for each finder sleeve.



Part No.	Screw Size	D Max.		D Min.		Sleeve Length G		Sleeve Diameter E	
		In.	mm	In.	mm	In.	mm	In.	mm
NOL	4F-5R	.232	5.89	.217	5.51	1 7/8	47.6	3/8	9.5
L 	5F-6R	.260	6.60	.233	5.92	1 7/8	47.6	3/8	9.5
M 	6F-6R	.309	7.85	.261	6.63	1 7/8	47.6	7/16	11.1
P 	8F-6R	.368	9.35	.310	7.87	1 7/8	47.6	1/2	12.7
NP	8F-10R	.368	9.35	.310	7.87	1 7/8	47.6	7/16	11.1
R 	10F-12R	.415	10.54	.369	9.37	2	50.8	9/16	14.3
S 	12F-14R	.478	12.14	.416	10.57	2	50.8	5/8	15.9
T 	14F-16R	.522	13.26	.479	12.17	2 1/8	54.0	11/16	17.5
U	16F-20R	.621	15.77	.523	13.28	2 1/8	54.0	3/4	19.1
W	20F-22R	.665	16.89	.622	15.80	2 1/16	52.4	13/16	20.3
Y	24F-24R	.715	18.16	.666	16.92	2 1/32	51.6	15/16	23.8

Slotted Power Bits with Finder Sleeves



1/4" Hex Power Drive



Part No. Complete Assembly	Part No. Bit Only	Screw Size	Bit Length		Blade Thickness		Bit Body Diameter	
			In.	mm	In.	mm	In.	mm
NOL-320	320-LX	4F-5R	3 3/4	95	.036	.91	.193	4.90
L-320X	320-LX	5F-6R	3 3/4	95	.036	.91	.193	4.90
M-320X	320-MX	6F-8R	3 3/4	95	.038	.97	.241	6.12
P-320X	320-PX	8F-10R	3 3/4	95	.042	1.07	.290	7.37
R-320X	320-RX	10F-12R	3 3/4	95	.046	1.17	.350	8.89
S-320	320-S	12F-14R	3 7/8	98	.050	1.27	.395	10.03
T-320X	320-TX	14F-16R	4 1/8	105	.055	1.40	.457	11.61

1/4" Hex Power Drive – Extra Short Series



Part No. Complete Assembly	Part No. Bit Only	Screw Size	Bit Length		Blade Thickness		Bit Body Diameter	
			In.	mm	In.	mm	In.	mm
OOOL-322	322-000L	2F-3R	2 3/32	53	.026	.66	.138	3.91
OOL-322	322-00L	3F-4R	2 3/32	53	.030	.76	.154	3.91
OL-322	322-0L	4F-5R	2 5/32	55	.034	.86	.185	4.70
L-322	322-L	5F-6R	2 5/32	55	.036	.91	.185	4.70
M-322	322-M	6F-8R	2 5/32	55	.040	1.02	.248	6.30
P-322	322-P	8F-10R	2 5/32	55	.042	1.07	.283	7.19
R-322	322-R	10F-12R	2 5/32	55	.046	1.17	.283	7.19

1/4" Hex Power Drive – Long Series



Part No. Complete Assembly	Part No. Bit Only	Screw Size	Bit Length		Blade Thickness		Bit Body Diameter	
			In.	mm	In.	mm	In.	mm
L-328	328-L	5F-6R	6 1/2	165	.036	.91	.193	4.90
M-328	328-M	6F-8R	6 1/2	165	.038	.97	.241	6.12
P-328	328-P	8F-10R	6 1/2	165	.046	1.07	.290	7.37
R-328	328-R	10F-12R	6 1/2	165	.046	1.17	.350	8.89
S-328	328-S	12F-14R	6 1/2	165	.050	1.27	.395	10.03
T-328	328-T	14F-16R	6 1/2	165	.055	1.40	.457	11.61

Slotted Bits



7/16" Hex Power Drive with Finder Sleeves

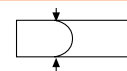

Part Number	Screw Size	Bit Length		Blade Thickness		Bit Body Diameter	
		In.	mm	In.	mm	In.	mm
M-321	6F-8R	3 3/4	95	.038	.97	.241	6.12
P-321	8F-10R	3 3/4	95	.046	1.07	.290	7.37
R-321	10F-12R	3 7/8	98	.046	1.17	.350	8.89
S-321	12F-14R	3 7/8	98	.050	1.27	.395	10.03
T-321	14F-16R	4 1/8	105	.055	1.40	.457	11.61
U-321	16F-20R	4 1/8	105	.060	1.52	.503	12.78
W-321	20F-22R	4 1/8	105	.062	1.57	.545	13.84
Y-321	24F-24R	4 1/8	105	.065	1.65	.595	15.11

See chart on page 14 for sleeve diameters.





















Fein Drive



Part Number	Width X Thickness (mm)	Length	
		In.	mm
FND-320-A	3 X .5	2 1/8	53
FND-320-B	4 X .5	2 1/8	53
FND-320-C	3.5 X .6	2 1/8	53
FND-320-E	4 X .8	2 1/8	53
FND-320-F	5.5 X .8	2 1/8	53
FND-320-H	6.5 X 1.2	2 1/8	53
FND-320-I	8 X 1.2	2 1/8	53

1/4" Hex Insert Bits









Part Number	Torxalign® Part Number	Driver Size	A (Ref.)		Overall Length In.	Overall Length mm
440-TX-05X 	-	T-5	.055		1	25
440-TX-06X 	-	T-6	.065		1	25
440-TX-07X 	-	T-7	.077		1	25
440-TX-08X 	-	T-8	.090		1	25
440-TX-09X 	-	T-9	.097		1	25
440-TX-10X 	440-TX-10-W	T-10	.107		1	25
440-TX-15X 	440-TX-15-W 	T-15	.128		1	25
440-TX-15-125	-	T-15	.128		1 1/4	32
440-TX-20X 	440-TX-20-W 	T-20	.151		1	25
440-TX-20-125	-	T-20	.151		1 1/4	32
440-TX-20-2	-	T-20	.151		2	51
440-TX-25X 	440-TX-25-W 	T-25	.173		1	25
440-TX-27X 	440-TX-27-W	T-27	.195		1	25
440-TX-30X 	440-TX-30-W 	T-30	.216		1	25
440-TX-40X 	440-TX-40-W	T-40	.260		1	25
440-TX-40I 	440-TX-40-W	T-40	.260		1	25
440-TX-45X* 	-	T-45	.306		1 1/4	32
440-TX-50X* 	-	T-50	.346		1 1/4	32

* Hex will break before rated ultimate torque of the Torx® point is met.

1/4" Hex Insert Bits – Tamper Resistant** 









Part Number	Driver Size	A (Ref.)		Overall Length In.	Overall Length mm
440-TX-07-H	T-7-H	.077		1	25
440-TX-08-H	T-8-H	.090		1	25
440-TX-09-H	T-9-H	.097		1	25
440-TX-10-H 	T-10-H	.107		1	25
440-TX-15-H 	T-15-H	.128		1	25
440-TX-20-H 	T-20-H	.151		1	25
440-TX-25-H 	T-25-H	.173		1	25
440-TX-27-H 	T-27-H	.195		1	25
440-TX-30-H 	T-30-H	.216		1	25
440-TX-40-H	T-40-H	.260		1	25

** Tamper resistant Torx® screws feature a post in the center of the recess—this post will only fit into a tamper resistant Torx® bit. Tamper resistant Torx® bits are available on a restricted distribution basis. Contact your local Apex representative for details.

5/16” Hex Insert Bits



Part Number	Driver Size	A (Ref.)		Overall Length	
				In.	mm
480-TX-20	T-20	.151		1 1/4	32
480-TX-25	T-25	.173		1 1/4	32
480-TX-27	T-27	.195		1 1/4	32
480-TX-30X 	T-30	.216		1 1/4	32
480-TX-40X 	T-40	.260		1 1/4	32
480-TX-40-4	T-40	.260		4	102
480-TX-45X 	T-45	.306		1 1/4	32
480-TX-45-6	T-45	.306		6	152
480-TX-50X 	T-50	.346		1 1/4	32
480-TX-55X 	T-55	.440		1 1/4	32

5/16” Hex Insert Bits – Tamper Resistant** 





Part Number	Driver Size	A (Ref.)		Overall Length	
				In.	mm
480-TX-40-H	T-40-H	.260		1 1/4	32
480-TX-45-H	T-45-H	.306		1 1/4	32
480-TX-50-H	T-50-H	.346		1 1/4	32
480-TX-55-H	T-55-H	.440		1 1/4	32

**Tamper resistant Torx® bits are available on a restricted distribution basis. Contact your local Apex representative for details.

5/8” Hex Insert Bits



Part Number	Hex Flat Type*	Driver Size	A (Ref.)		Overall Length	
					In.	mm
SZ-TX-55-A 	DP	T-55	.440		1 9/16	40
SZ-TX-60-A	DP	T-60	.520		1 9/16	40
SZ-TX-70-A	DP	T-70	.610		1 9/16	40
SZ-TX-70-A-3	TH	T-70	.610		3	76
SZ-TX-80-A	TH	T-80	.689		1 9/16	40

*DP-Drill Point; TH-Thru Hole. 5/8” insert bits are used with SC and RP adapters found on pages 51.

7/8” Hex Insert Bits

































Part Number	Hex Flat Type*	Driver Size	A (Ref.)		Overall Length	
					In.	mm
SZ-TX-90-A	TH	T-90	.782		2	51
SZ-TX-100-A	TH	T-100	.870		2	51

*TH-Thru Hole. 7/8” insert bits are used with RP adapters found on pages 51.

1/4" Hex Power Drive





Part Number	Driver Size	A (Ref.)		Body Diameter		Overall Length	
				In.	mm	In.	mm
49-TX-05	T-5	.055		.119	3.0	1 15/16	49
49-A-TX-05	T-5	.055		.119	3.0	2 3/4	70
49-B-TX-05	T-5	.055		.119	3.0	3 1/2	89
49-TX-06 	T-6	.065		.119	3.0	1 15/16	49
49-A-TX-06	T-6	.065		.119	3.0	2 3/4	70
49-TX-07 	T-7	.077		.119	3.0	1 15/16	49
49-A-TX-07	T-7	.077		.119	3.0	2 3/4	70
49-B-TX-07	T-7	.077		.119	3.0	3 1/2	89
49-C-TX-07	T-7	.077		.119	3.0	6	152
49-TX-08 	T-8	.090		.119	3.0	1 15/16	49
49-A-TX-08 	T-8	.090		.119	3.0	2 3/4	70
49-B-TX-08 	T-8	.090		.119	3.0	3 1/2	89
49-C-TX-08 	T-8	.090		.119	3.0	6	152
49-TX-09	T-9	.097		.119	3.0	1 15/16	49
49-A-TX-09	T-9	.097		.119	3.0	2 3/4	70
49-B-TX-09	T-9	.097		.119	3.0	3 1/2	89
49-C-TX-09	T-9	.097		.119	3.0	6	152
49-TX-10 	T-10	.107		.150	3.8	1 15/16	49
49-A-TX-10 	T-10	.107		.150	3.8	2 3/4	70
SD-4693	T-10	.107		.150	3.8	3	75
49-B-TX-10 	T-10	.107		.150	3.8	3 1/2	89
49-C-TX-10 	T-10	.107		.150	3.8	6	152
49-TX-15 	T-15	.128		.150	3.8	1 15/16	49
49-A-TX-15 	T-15	.128		.150	3.8	2 3/4	70
49-B-TX-15 	T-15	.128		.150	3.8	3 1/2	89
49-C-TX-15 	T-15	.128		.150	3.8	6	152
49-TX-20 	T-20	.151		.171	4.3	1 15/16	49
49-A-TX-20 	T-20	.151		.171	4.3	2 3/4	70
49-B-TX-20 	T-20	.151		.171	4.3	3 1/2	89
49-TX-20-5	T-20	.151		.171	4.3	5	127
49-C-TX-20 	T-20	.151		.171	4.3	6	152
49-TX-25 	T-25	.173		.193	4.9	1 15/16	49
49-A-TX-25 	T-25	.173		.193	4.9	2 3/4	70
49-B-TX-25 	T-25	.173		.193	4.9	3 1/2	89
49-C-TX-25 	T-25	.173		.193	4.9	6	152
49-TX-27 	T-27	.195		.215	5.5	1 15/16	49
49-A-TX-27	T-27	.195		.215	5.5	2 3/4	70
49-B-TX-27	T-27	.195		.215	5.5	3 1/2	89
49-C-TX-27	T-27	.195		.215	5.5	6	152
49-TX-30 	T-30	.216		.236	6.0	1 15/16	49
49-A-TX-30 	T-30	.216		.236	6.0	2 3/4	70
49-B-TX-30 	T-30	.216		.236	6.0	3 1/2	89
49-C-TX-30 	T-30	.216		.236	6.0	6	152
49-TX-40 	T-40	.260		.309	7.8	1 15/16	49
49-A-TX-40	T-40	.260		.309	7.8	2 3/4	70
49-B-TX-40	T-40	.260		.309	7.8	3 1/2	89
49-C-TX-40	T-40	.260		.309	7.8	6	152

 Refer to Page iv for description of Rapid Select.

1/4" Hex Power Drive – Torxalign®



Part Number	Driver Size	A (Ref.)		Body Diameter		Overall Length	
				In.	mm	In.	mm
49-TX-08-W	T-8	.090		.119	3.0	1 15/16	49
49-TX-09-W	T-9	.097		.119	3.0	1 15/16	49
49-TX-10-W	T-10	.107		.150	3.8	1 15/16	49
49-TX-15-W	T-15	.128		.150	3.8	1 15/16	49
49-A-TX-15-W	T-15	.128		.150	3.8	2 3/4	70
49-B-TX-15-W	T-15	.128		.150	3.8	3 1/2	89
49-TX-20-W	T-20	.151		.171	4.3	1 15/16	49
49-B-TX-20-W	T-20	.151		.171	4.3	3 1/2	89
49-TX-25-W 	T-25	.173		.193	4.9	1 15/16	49
49-TX-27-W	T-27	.195		.215	5.5	1 15/16	49
49-TX-30-W	T-30	.216		.236	6.0	1 15/16	49
49-B-TX-30-W	T-30	.216		.236	6.0	3 1/2	89

1/4" Hex Power Drive – Tamper Resistant **



Part Number	Driver Size	A (Ref.)		Body Diameter		Overall Length	
				In.	mm	In.	mm
49-TX-10-H	T-10-H	.107		.150	3.8	1 15/16	49
49-A-TX-10-H	T-10-H	.107		.150	3.8	2 3/4	70
49-TX-15-H	T-15-H	.128		.150	3.8	1 15/16	49
49-A-TX-15-H	T-15-H	.128		.150	3.8	2 3/4	70
49-B-TX-15-H	T-15-H	.128		.150	3.8	3 1/2	89
49-A-TX-20-H	T-20-H	.151		.171	4.3	2 3/4	70
49-B-TX-20-H	T-20-H	.151		.171	4.3	3 1/2	89
49-C-TX-20-H	T-20-H	.151		.171	4.3	6	152

**Tamper resistant Torx® bits are available on a restricted distribution basis. Contact your local Apex representative for details.

1/4" Hex Power Drive with Finder Sleeves





Part Number	Driver Size	Sleeve Number*	A (Ref.)		Sleeve Diameter		Overall Length	
					In.	mm	In.	mm
M-32-TX-15	T-15	M	.128		.437	12.1	3 1/2	89
M-32-TX-20	T-20	M	.151		.437	12.1	3 1/2	89
NP-32-TX-25	T-25	NP	.173		.437	12.1	3 3/4	95
R-32-TX-27	T-27	R	.195		.563	14.3	3 5/8	92
S-32-TX-30	T-30	S	.216		.625	15.9	3 7/8	98

*See page 14 for Sleeve Selection

7/16" Hex Power Drive





Part Number	Driver Size	A (Ref.)		Body Diameter		Overall Length	
				In.	mm	In.	mm
48-TX-40	T-40	.260		.277	7.0	3 1/2	89
48-TX-45	T-45	.306		.323	8.2	3 1/2	89
48-TX-50 	T-50	.346		.363	9.2	3 1/2	89
48-TX-55	T-55	.440		.503	12.8	3 3/4	95

Torx® and Torxalign® are registered trademarks of the Camcar Division of Textron.

 Refer to Page iv for description of Rapid Select.



10-32 Screw Shank Drive



Part Number	Driver Size	A (Ref.)		Body Diameter		Overall Length	
				In.	mm	In.	mm
50-TX-08 	T-8	.090		.125	3.2	1 1/2	38
50-TX-10	T-10	.107		.150	3.8	1 1/2	38
50-TX-15	T-15	.128		.150	3.8	1 1/2	38
50-TX-20	T-20	.151		.171	4.3	1 1/2	38



12-24 Screw Shank Drive



Part Number	Driver Size	A (Ref.)		Body Diameter		Overall Length	
				In.	mm	In.	mm
55-TX-10	T-10	.107		.150	3.8	1 3/16	30
55-TX-15	T-15	.128		.150	3.8	1 3/16	30
SD-4048	T-15	.128		.309	7.8	1 3/16	30
55-TX-20 	T-20	.151		.171	4.3	1 3/16	30
55-TX-25	T-25	.173		.193	4.9	1 3/16	30
55-TX-30	T-30	.216		.309	7.8	1 3/16	30

Female Square Service Drive



Part Number	Driver Size	A (Ref.)		Square Drive	Body Diameter		Overall Length	
					In.	mm	In.	mm
834-TX-25	T-25	.173		3/8	.240	6.1	2 13/16	71
834-TX30-1.62	T-30	.216		3/8	.234	5.9	1 5/8	41
834-TX40-2.95	T-40	.260		3/8	.277	7.0	2 61/64	75
834-TX50-1.62	T-50	.346		3/8	.373	9.4	1 1/4	41
834-TX-45-5	T-45	.306		3/8	.323	8.2	5	125
834-TX-50	T-50	.346		3/8	.363	9.2	2 5/8	66
854-TX-50 	T-50	.346		1/2	.323	8.2	2 7/8	73
854-TX-55-150M	T-55	.346		1/2	.363	9.2	5 7/8	150

1" Square Drive Adapters with Torx® Insert Bit



Part Number	Driver Size	A (Ref.)		Overall Length		Bit Length (B)	
				In.	mm	In.	mm
SZ-8L-TX-70	T-70	.610		3 19/32	91	.90	23
SZ-TX-100	T-100	.870		3 19/32	91	1.13	29

Fein Drive



Part Number	Driver Size	A (Ref.)		Overall Length	
				In.	mm
FND-TX10	T-10	.107		2 3/4	70
FND-TX20	T-20	.151		2 3/4	70
FND-TX25	T-25	.173		2 3/4	70
FND-TX27	T-27	.195		2 3/4	70
FND-TX30	T-30	.216		2 3/4	70



1/4" Hex Insert Bits



Part Number	Driver Size	A (Ref.)		Overall Length	
				In.	mm
440-10IP	10IP	.107		1	25
440-15IP	15IP	.128		1	25
440-20IP	20IP	.151		1	25
440-25IP	25IP	.173		1	25
440-27IP	27IP	.195		1	25
440-30IP	30IP	.216		1	25
440-40IP	40IP	.260		1	25

1/4" Hex Power Drive



Part Number	Driver Size	A (Ref.)		Overall Length	
				In.	mm
49-10IP	10IP	.107		1 15/16	49
49-A-10IP	10IP	.107		2 3/4	70
49-B-10IP	10IP	.107		3 1/2	89
49-15IP	15IP	.128		1 15/16	49
49-A-15IP	15IP	.128		2 3/4	70
49-B-15IP	15IP	.128		3 1/2	89
49-20IP	20IP	.151		1 15/16	49
49-A-20IP	20IP	.151		2 3/4	70
49-B-20IP	20IP	.151		3 1/2	89
49-25IP	25IP	.173		1 15/16	49
49-A-25IP	25IP	.173		2 3/4	70
49-B-25IP	25IP	.173		3 1/2	89
49-27IP	27IP	.195		1 15/16	49
49-A-27IP	27IP	.195		2 3/4	70
49-B-27IP	27IP	.195		3 1/2	89
49-30IP	30IP	.216		1 15/16	49
49-A-30IP	30IP	.216		2 3/4	70
49-B-30IP	30IP	.216		3 1/2	89
49-40IP	40IP	.260		1 15/16	49
49-A-40IP	40IP	.260		2 3/4	70
49-B-40IP	40IP	.260		3 1/2	89

Torx Plus® is a trademark of the Camcar Division of Textron.

Torx Plus® Tamper Resistant Bits are available on a limited basis. Please contact your Area Distributor or Representative for more details.

1/4" Hex Insert Bits



Part Number	Point Size	Overall Length	
		In.	mm
440-1-PZD	1	1	25
440-125-PZD	1	2 1/2	64
440-2-PZDX 	2	1	25
440-215-PZD	2	1 1/2	38
440-22-PZD	2	2	51
440-225-PZD	2	2 1/2	64
440-3-PZD	3	1	25
440-4-PZD	4	1 1/4	32

1/4" Hex Insert Bits – Limited Clearance

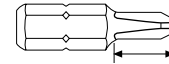

Part Number	Point Size	Overall Length		Turned Length	
		In.	mm	In.	mm
446-1-PZD	1	1	25.4	7/16	11
446-2-PZDX 	2	1	25.4	7/16	11
446-22-PZD	2	2	50.8	7/16	11



5/16" Hex Insert Bits

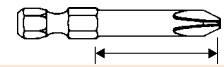

Part Number	Point Size	Overall Length		
		In.	mm	
480-1-PZD	1	1 1/4	32	
480-2-PZD	2	1 1/4	32	
480-3-PZD	3	1 1/4	32	
480-4-PZD	4	1 1/4	32	
480-4BN-PZD	4	1 1/2	38	Large body

1/4" Hex Power Drive



Part Number	Point Size	Overall Length		Body Diameter		Turned Length	
		In.	mm	In.	mm	In.	mm
491-PZD	1	1 15/16	49	3/16	4.8	1 1/4	32
491-A-PZD	1	2 3/4	70	3/16	4.8	2	51
491-B-PZD	1	3 1/2	89	3/16	4.8	2 3/4	70
491-C-PZD	1	6	152	3/16	4.8	2	51
492-PZDX 	2	1 15/16	49	1/4	6.4	1 1/4	32
492-A-PZDX 	2	2 3/4	70	1/4	6.4	2	51
492-B-PZDX 	2	3 1/2	89	1/4	6.4	2 3/4	70
492-C-PZD	2	6	152	1/4	6.4	2	51
493-PZD	3	1 15/16	49	5/16	7.9	1	25
493-A-PZD	3	2 3/4	70	5/16	7.9	1 3/4	44
493-B-PZD	3	3 1/2	89	5/16	7.9	2 1/4	57
493-C-PZD	3	6	152	5/16	7.9	5	127

1/4"-24 Screw Shank Drive



Part Number	Point Size	Overall Length		Body Diameter	
		In.	mm	In.	mm
401-PZD	1	1 1/2	38	3/16	4.8
402-PZD	2	1 1/2	38	1/4	6.4
403-PZD	3	1 1/2	38	5/16	7.9

8-32 Screw Shank Drive



Part Number	Point Size	Overall Length		Body Diameter	
		In.	mm	In.	mm
591-PZD	1	1 3/16	30	7/32	5.6
592-PZD	2	1 3/16	30	7/32	5.6

10-32 Screw Shank Drive



Part Number	Point Size	Overall Length		Body Diameter	
		In.	mm	In.	mm
502-PZD	2	1 1/2	38	1/4	6.4
SD-1342-2-PZD	2	1 3/4	45	1/4	6.4

Fein Drive



Part Number	Point Size	Overall Length	
		In.	mm
FND-1PZD	1	2	53
FND-2PZD	2	2	53
FND-2PZD-70M	2	2 3/4	70
FND-3PZD	3	2	53
FND-3PZD-70M	3	2 3/4	70

1/4" Hex Insert Bits



Part Number	Point Size	Overall Length	
		In.	mm
440-1-SF	1	1	25
440-2-SF	2	1	25
440-215-SF	2	1 1/2	38
440-22-SF	2	2	51
440-225-SF	2	2 1/2	64
440-3-SF	3	1	25
440-4-SF	4	1 1/4	32

1/4" Hex Insert Bits – Limited Clearance

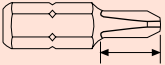

Part Number	Point Size	Overall Length		Turned Length		
		In.	mm	In.	mm	
446-1-SF	1	1	25	7/16	11	
446-2-SF	2	1	25	7/16	11	

5/16" Hex Insert Bits



Part Number	Point Size	Overall Length		Large body
		In.	mm	
480-2-SF	2	1 1/4	32	
480-3-SF	3	1 1/4	32	
480-4-SF	4	1 1/4	32	
480-4BN-SF	4	1 1/2	38	Large body

1/4" Hex Power Drive

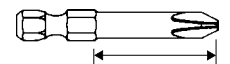

Part Number	Point Size	Overall Length		Body Diameter		Turned Length	
		In.	mm	In.	mm	In.	mm
491-SF	1	1 15/16	49	3/16	5	1 1/4	32
491-A-SF	1	2 3/4	70	3/16	5	2	51
491-B-SF	1	3 1/2	89	3/16	5	2 3/4	70
491-C-SF	1	6	152	3/16	5	2	51
492-SF	2	1 15/16	49	1/4	6	1 1/4	32
492-A-SF	2	2 3/4	70	1/4	6	2	51
492-B-SF	2	3 1/2	89	1/4	6	2 3/4	70
492-C-SF	2	6	152	1/4	6	2	51
493-SF	3	1 15/16	49	5/16	8	1	25
493-A-SF	3	2 3/4	70	5/16	8	1 3/4	44
493-B-SF	3	3 1/2	89	5/16	8	2 1/2	64
493-C-SF	3	6	152	5/16	8	5	127

Sel-O-Fit® bits are designed to provide a more efficient means of driving Pozidriv® screws. The Sel-O-Fit bit places torque on the strongest and most mechanically advantageous portion of the driver tip. This allows more torque to be applied while minimizing the possibility of breakage and camout. Sel-O-Fit® is a registered trademark of Cooper Industries.

1/4" Hex Insert Bits



Part Number	Point Size	Overall Length		
		In.	mm	
440-F	All	1	25	
446-F	All	1	25	For limited clearance

5/16" Hex Insert Bit



Part Number	Point Size	Overall Length	
		In.	mm
480-F	All	1 3/8	35

1/4" Hex Power Drive

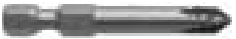

Part Number	Screw Size	Overall Length		Body Diameter		Turned Length	
		In.	mm	In.	mm	In.	mm
491-F	All	1 15/16	49	3/16	5	1 1/4	32
491-AF	All	2 3/4	70	3/16	5	2	51
491-BF	All	3 1/2	89	3/16	5	2 3/4	70
491-CF	All	6	152	3/16	5	2	51
492-F	All	1 15/16	49	1/4	6	1 1/4	32
492-AF	All	2 3/4	70	1/4	6	2	51
492-BF	All	3 1/2	89	1/4	6	2 3/4	70
492-CF	All	6	152	1/4	6	2	51
493-F	All	1 15/16	49	5/16	8	1	25
493-AF	All	2 3/4	70	5/16	8	1 3/4	44
493-BF	All	3 1/2	89	5/16	8	2 1/2	64
493-CF	All	6	152	5/16	8	5	127

The Frearson recess is designed so that any size bit will fit any size recess.
Choose bits on the basis of body diameter – the larger the screw, the larger the body diameter.

Frearson Bits

12-24 Screw Shank Drive



Part Number	Screw Size	Overall Length		Body Diameter	
		In.	mm	In.	mm
552-F	All	1 3/16	30	.30	8

1/4" Female Square Drive



Part Number	Screw Size	Overall Length		Body Diameter	
		In.	mm	In.	mm
822-F	All	2	51	1/4	6

3/8" Female Square Drive



Part Number	Screw Size	Overall Length		Body Diameter	
		In.	mm	In.	mm
832-F	All	2 5/8	67	1/4	6
833-F	All	2 5/8	67	5/16	8
834-F	All	2 5/8	67	3/8	10

B.N.A.E. Bits

1/4" Hex Insert Bits



Part Number	Point Size	Overall Length	
		In.	mm
BNAE-3mm	3mm	1 1/8	29
BNAE-4mm	4mm	1 1/8	29
BNAE-5mm	5mm	1 1/8	29
BNAE-6mm	6mm	1 1/8	29
BNAE-8mm	8mm	1 1/8	29

1/4" Hex Insert Bits – ACR®



Part Number	Point Size	Overall Length	
		In.	mm
BNAE-4mm-ACR	4mm	1 1/8	29
BNAE-5mm-ACR	5mm	1 1/8	29
BNAE-6mm-ACR	6mm	1 1/8	29



ACR® ribs for both removal and driving

Socket Head Sizing Chart



SAE



Nominal Hex Size, Inches	Socket Head Cap Screws 1960 Series	Socket Head Cap Screws 1936 Series	Flat Head Cap Screws	Button Head Cap Screws	Set Screws	Shoulder Screws	Pressure Plugs	Allenuts	Low Head Cap Screws
.050	0	0, 1	1, 2	3, 4	—	—	—	4	.050
1/16	1	2	3, 4	3, 4	5, 6	—	—	—	5, 6
5/64	2, 3	3, 4	5, 6	5, 6	8	—	—	—	8
3/32	4, 5	5, 6	8	8	10	—	—	—	10
7/64	6	—	—	—	—	—	—	—	—
1/8	—	8	10	10	1/4	1/4	—	4, 5	1/4
9/64	8	10	—	—	—	—	—	—	—
5/32	10	1/4	1/4	1/4	5/16	5/16	1/16	6	5/16
3/16	1/4	—	5/16	5/16	3/8	3/8	1/8	8, 10	3/8
7/32	—	5/16	3/8	3/8	7/16	—	—	—	7/16
1/4	5/16	—	7/16	—	1/2	1/2	1/4	1/4	1/2
5/16	3/8	3/8, 7/16	1/2	—	5/8	5/8	3/8	5/16	5/8
3/8	7/16, 1/2	1/2	5/8	—	3/4	3/4	1/2	3/8	—
7/16	—	—	—	—	—	—	—	7/16	—
1/2	5/8	5/8	3/4	—	7/8	1	—	1/2	—
9/16	—	3/4, 7/8	7/8	—	1, 1 1/8	—	3/4	—	—
5/8	3/4	1	1	—	1 1/4, 1 3/8	1 1/4	1	5/8	—
3/4	7/8, 1	1 1/8, 1 1/4, 1 3/8	1 1/8	—	1 1/2	—	1 1/4	3/4	—
7/8	1 1/8, 1 1/4	—	1 1/4, 1 3/8	—	—	1 1/2	—	7/8	—
1	1 3/8, 1 1/2	1 1/2	1 1/2	—	1 3/4, 2	1 3/4	1 1/2, 2	1	—
1 1/4	1 3/4	—	—	—	—	2	—	1 1/4	—
1 1/2	2	—	—	—	—	—	—	1 1/2	—
1 3/4	2 1/4, 2 1/2	—	—	—	—	—	—	—	1 3/4
2	2 3/4	—	—	—	—	—	—	—	—

Metric



Nominal hex Size, MM	Socket Head Cap Screws	Flat Head Cap Screws	Button Head Cap Screws	Set Screws	Shoulder Screws	Allenuts	Low Head Cap Screws
1.5	M1.6, M1.7, M2	—	—	M3	—	—	—
2	M2.3, M2.5, M2.6	M3	M3	M4	—	—	—
2.5	M3	M4	M4	M5	—	—	—
3	M4	M5	M5	M6	6mm	M3	M4
4	M5	M6	M6	M8	8mm	M4	M5
5	M6	M8	M8	M10	10mm	M5	M6
6	M8	M10	M10	M12, M14	12mm	M6	M8
8	M10	M12	M12	M16	16mm	M8	M10
10	M12	M14, M16	—	M20	20mm	M10	M12
12	M14	M20	—	M24	—	M12	M14
14	M16	—	—	—	—	—	M16
17	M20	—	—	—	—	M16	M20, M22
19	M24	—	—	—	—	—	M24



1/4" Hex Insert Bits



Part Number	Hex Size	Overall Length	
		In.	mm
185-000X	.050	1	25
185-00	1/16	1	25
185-0	5/64	1	25
185-1X	3/32	1	25
185-9X	7/64	1	25
185-2X	1/8	1	25
185-10X	9/64	1	25
185-3X	5/32	1 5/16	33
185-4X	3/16	1 5/16	33
185-4-4	3/16	4	102
185-5	7/32	1 5/16	33
185-6	1/4	1 5/16	33
185-7	5/16	1 1/4	32
185-8	3/8	1 1/4	32

1/4" Hex Insert Bits – Metric



Part Number	Hex Size	Overall Length	
		In.	mm
185-1.5mm	1.5mm	1	25
185-2mm	2mm	1	25
185-2.5mm	2.5mm	1	25
185-3mm	3mm	1	25
185-4mm	4mm	1 5/16	33
185-5mm	5mm	1 5/16	33
185-6mm	6mm	1 5/16	33
185-7mm	7mm	1 1/4	32
185-8mm	8mm	1 1/4	32
185-9mm	9mm	1 1/4	32
185-10mm	10mm	1 1/4	32

5/16" Hex Insert Bits



Part Number	Hex Size	Overall Length	
		In.	mm
315-3	5/32	1 5/16	33
315-4	3/16	1 5/16	33
315-5	7/32	1 5/16	33
315-6	1/4	1 5/16	33
315-7	5/16	1 5/16	33
315-8	3/8	1 5/16	33

Socket Head Bits













5/16" Hex Insert Bits – Metric



Part Number	Hex Size	Overall Length	
		In.	mm
315-2.5mm	2.5mm	1	25
315-3mm	3mm	1	25
315-4mm	4mm	1 5/16	33
315-5mm	5mm	1 5/16	33
315-6mm	6mm	1 5/16	33
315-7mm	7mm	1 5/16	33
315-8mm	8mm	1 5/16	33
315-9mm	9mm	1 5/16	33
315-10mm	10mm	1 3/8	35
315-12mm	12mm	1 1/4	32
315-14mm	14mm	1 1/4	32

1/4" Hex Power Drive



Part Number	Hex Size	Overall Length	
		In.	mm
AM-02 	1/16	1 15/16	49
AM-02-A 	5/64	1 15/16	49
AM-03 	3/32	1 15/16	49
AM-03-3	3/32	3	76
AM-03-6	3/32	6	152
AM-03-A 	7/64	1 15/16	49
AM-04 	1/8	1 15/16	49
AM-04-3	1/8	3	76
AM-04-35	1/8	3 1/2	89
AM-04-4 	1/8	4	102
AM-04-5	1/8	5	127
AM-04-6	1/8	6	152
AM-04-A	9/64	1 15/16	49
AM-04-A-4	9/64	4	102
AM-05 	5/32	1 15/16	49
AM-05-3	5/32	3	76
AM-05-35	5/32	3 1/2	89
AM-05-4 	5/32	4	102
AM-05-5	5/32	3	127
AM-05-6	5/32	6	152
AM-05-8	5/32	8	203
AM-06 	3/16	1 15/16	49
AM-06-3	3/16	3	76
AM-06-4	3/16	4	102
AM-06-6 	3/16	6	152
AM-07	7/32	1 15/16	49
AM-08	1/4	1 15/16	49
AM-10	5/16	1 15/16	49

Socket Head Bits



1/4" Hex Power Drive – Metric



Part Number	Hex Size	Overall Length	
		In.	mm
AM-1.5mm	1.5mm	1 15/16	49
AM-2mm 	2mm	1 15/16	49
AM-2.5mm 	2.5mm	1 15/16	49
AM-3mm 	3mm	1 15/16	49
AM-3mm-3	3mm	3	76
AM-3mm-4	3mm	4	102
AM-4mm 	4mm	1 15/16	49
AM-5mm 	5mm	1 15/16	49
AM-5mm-4	5mm	4	102
AM-6mm 	6mm	1 15/16	49
AM-6mm-4	6mm	4	102
AM-7mm	7mm	1 15/16	49
AM-8mm	8mm	1 15/16	49
AM-10mm	10mm	1 15/16	49

5/16" Hex Power Drive







Part Number	Hex Size	Overall Length	
		In.	mm
AS-04	1/8	3	76
AS-05	5/32	3	76
AS-06	3/16	3	76
AS-07	7/32	3	76
AS-08	1/4	3	76
AS-10	5/16	3	76
AS-12	3/8	3	76

Socket Head Bits



7/16" Hex Power Drive



Part Number	Hex Size	Overall Length	
		In.	mm
AN-04	1/8	3 1/2	89
AN-04-A	9/64	3 1/2	89
AN-05 	5/32	3 1/2	89
AN-05-6	5/32	6	152
AN-06 	3/16	3 1/2	89
AN-06-6	3/16	6	152
AN-07	7/32	3 1/2	89
AN-07-8	7/32	8	203
AN-08 	1/4	3 1/2	89
AN-08-8	1/4	8	203
AN-09	9/32	3 1/2	89
AN-10 	5/16	3 1/2	89
AN-10-6	5/16	6	152
AN-12 	3/8	3 1/2	89
AN-12-6	3/8	6	152
AN-16	1/2	3 1/2	89
AN-16-6	1/2	6	152

7/16" Hex Power Drive—Metric



Part Number	Hex Size	Overall Length	
		In.	mm
AN-3mm	3mm	3 1/2	89
AN-4mm	4mm	3 1/2	89
AN-5mm	5mm	3 1/2	89
AN-6mm	6mm	3 1/2	89
AN-8mm	8mm	3 1/2	89
AN-10mm	10mm	3 1/2	89
AN-12mm	12mm	3 1/2	89
AN-14mm	14mm	3 1/2	89
AN-14mm-6	14mm	6	152

Socket Head Bits



5/8" Hex Power Drive



Part Number	Hex Size	Overall Length	
		In.	mm
AP-08	1/4	4	102
AP-10	5/16	4	102
AP-12	3/8	4	102
AP-16	1/2	4	102
AP-18	9/16	4	102
AP-20	5/8	4	102
AP-24	3/4	4	102

Fein Drive



Part Number	Hex Size	Overall Length	
		In.	mm
FND-185-3MM	3 mm	2	53
FND-185-4MM	4 mm	2	53
FND-185-5MM	5 mm	2	53
FND-185-8MM	8 mm	2	53

Socket Head Bits with Square Drive Adapters, SAE



3/8" Square Drive



Complete	Part Number		Hex Size	Overall Length		Length of Insert	
	Adapter Only	Insert Only		In.	mm	In.	mm
SZ-9	SC-314	SZ-9-A	3/32	2 1/4	57	1 3/8	35
SZ-7	SC-314	SZ-7-A	7/64	2 1/4	57	1 3/8	35
SZ-10	SC-314	SZ-10-A	1/8	2 1/4	57	1 3/8	35
SZ-11	SC-314	SZ-11-A	5/32	2 1/4	57	1 3/8	35
SZ-12	SC-314	SZ-12-A	3/16	2 1/4	57	1 3/8	35
SZ-13	SC-314	SZ-13-A	7/32	2 1/4	57	1 3/8	35
SZ-14	SC-314	SZ-14-A	1/4	2 1/4	57	1 3/8	35
SZ-15	SC-314	SZ-15-A	5/16	2 1/4	57	1 3/8	35
SZ-16	SC-314	SZ-16-A	3/8	2 1/4	57	1 3/8	35
SZ-17	SC-314	SZ-17-A	1/2	2 1/4	57	1 3/8	35
SZ-18	SC-314	SZ-18-A	9/16	2 1/4	57	1 3/8	35
SZ-19	SC-314	SZ-19-A	5/8	2 1/4	57	1 3/8	35

Refer to Page iv for description of Rapid Select.

Socket Head Bits with Square Drive Adapters, SAE



1/2" Square Drive



Complete	Part Number		Hex Size	Overall Length		Length of Insert	
	Adapter Only	Insert Only		In.	mm	In.	mm
SZ-40	SC-514	SZ-10-A	1/8	2 1/2	64	1 3/8	35
SZ-41	SC-514	SZ-11-A	5/32	2 1/2	64	1 3/8	35
SZ-20	SC-514	SZ-12-A	3/16	2 1/2	64	1 3/8	35
SZ-21	SC-514	SZ-13-A	7/32	2 1/2	64	1 3/8	35
SZ-22	SC-514	SZ-14-A	1/4	2 1/2	64	1 3/8	35
SZ-23	SC-514	SZ-15-A	5/16	2 1/2	64	1 3/8	35
SZ-24	SC-514	SZ-16-A	3/8	2 1/2	64	1 3/8	35
SZ-25	SC-514	SZ-17-A	1/2	2 1/2	64	1 3/8	35
SZ-42	SC-520	SZ-31-A	1/2	2 1/2	64	1 9/16	40
SZ-43	SC-514	SZ-18-A	9/16	2 1/2	64	1 3/8	35
SZ-44	SC-520	SZ-32-A	9/16	2 1/2	64	1 9/16	40
SZ-26	SC-514	SZ-19-A	5/8	2 1/2	64	1 3/8	35
SZ-27	RP-520	SZ-33-A	5/8	2 1/2	64	1 9/16	40

Adapters with an "SC" prefix feature a set screw for locking in the bit. An "RP" prefix indicates adapters with a thru hole for a spring pin.

7/16" Hex Insert Bit Only



Part Number	Hex Size	Overall Length	
		In.	mm
SZ-11-A-3	5/32	3	76
SZ-12-A-2	3/16	2	51
SZ-12-A-3	3/16	3	76
SZ-12-A-6	3/16	6	152
SZ-13-A-3	7/32	3	76
SZ-14-A-3	1/4	3	76
SZ-14-A-4	1/4	4	102
SZ-15-A-2	5/16	2	51
SZ-15-A-3	5/16	3	76
SZ-15-A-4	5/16	4	102
SZ-16-A-3	3/8	3	76
SZ-16-A-4	3/8	4	102

Use 7/16" Hex Insert Bits with 7/16" Female Hex Square drive adapters, page 51. These bits feature a thru hole on the hex flat for use with a spring pin.

Socket Head Bits with Square Drive Adapters, SAE



3/4" Square Drive

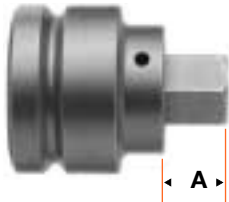

Complete	Part Number		Hex Size	Overall Length		Length of Insert		Bit Length (A)	
	Adapter Only	Insert Only		In.	mm	In.	mm	In.	mm
SZ-30	SC-720	SZ-30-A	3/8	2 5/8	67	1 9/16	40	29/32	23
SZ-31	SC-720	SZ-31-A	1/2	2 5/8	67	1 9/16	40	29/32	23
SZ-32	SC-720	SZ-32-A	9/16	2 5/8	67	1 9/16	40	29/32	23
SZ-33	RP-720	SZ-33-A	5/8	2 5/8	67	1 9/16	40	29/32	23
SZ-34	RP-720	SZ-34-A	3/4	2 5/8	67	1 9/16	40	29/32	23
SZ-37	RP-728	SZ-37-A	3/4	3 1/8	79	2	51	1 1/8	29
SZ-35	SC-720	SZ-35-A	7/8	2 5/8	67	1 9/16	40	29/32	23
SZ-38	RP-728	SZ-38-A	7/8	3 1/8	79	2	51	1 1/8	29
SZ-36	RP-720	SZ-36-A	1	2 5/8	67	1 9/16	40	29/32	23
SZ-39	RP-728	SZ-39-A	1	3 1/8	79	2	51	1 1/8	29

1" Square Drive

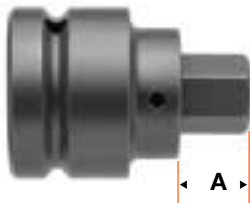

Complete	Part Number		Hex Size	Overall Length		Length of Insert		Bit Length (A)	
	Adapter Only	Insert Only		In.	mm	In.	mm	In.	mm
SZ-80	RP-820	SZ-31-A	1/2	3 1/16	78	1 9/16	40	29/32	23
SZ-82	RP-820	SZ-32-A	9/16	3 1/16	78	1 9/16	40	29/32	23
SZ-83	RP-828	SZ-83-A	9/16	3 1/4	83	2	51	1 1/8	29
SZ-84	RP-820	SZ-33-A	5/8	3 1/16	78	1 9/16	40	29/32	23
SZ-85	RP-828	SZ-85-A	5/8	3 1/4	83	2	51	1 1/8	29
SZ-86	RP-820	SZ-34-A	3/4	3 1/32	77	1 9/16	40	29/32	23
SZ-87	RP-828	SZ-37-A	3/4	3 1/4	83	2	51	1 1/8	29
SZ-88	SC-820	SZ-35-A	7/8	3 1/16	78	1 9/16	40	29/32	23
SZ-89	RP-828	SZ-38-A	7/8	3 1/4	83	2	51	1 1/8	29
SZ-91	RP-828	SZ-39-A	1	3 1/4	83	2	51	1 1/8	29
SZ-100	RP-848	SZ-100-A	1	3 1/16	78	2 1/2	64	1 3/8	35
SZ-101	RP-848	SZ-101-A	1 1/4	3 1/2	89	2 5/8	67	1 3/8	35
SZ-102	RP-848	SZ-102-A	1 1/2	3 3/4	95	2 5/8	67	1 3/8	35
SZ-104	RP-848	SZ-104-A	1 3/4	4 1/4	108	3 1/4	83	2 1/32	51

An "RP" prefix indicates adapters with a roll pin that is inserted through the bit.

Socket Head Bit and Adapter Sets



APH38	8 piece, 3/8" square drive: 1/8, 9/64, 5/32, 3/16, 7/32, 1/4, 5/16, 3/8
APH56	6 piece, 1/2" square drive: 1/4, 5/16, 3/8, 1/2, 9/16, 5/8

Socket Head Adapters & Inserts, Metric



3/8" Square Drive



Complete	Part Number		Hex Size	Overall Length		Length of Insert		Bit Length (A)	
	Adapter Only	Insert Only		In.	mm	In.	mm	In.	mm
SZ-3-7-4mm	SC-314	SZ-7-4mm	4mm	2 1/4	57	1 3/8	35	7/8	22
SZ-3-7-5mm	SC-314	SZ-7-5mm	5mm	2 1/4	57	1 3/8	35	7/8	22
SZ-3-7-6mm	SC-314	SZ-7-6mm	6mm	2 1/4	57	1 3/8	35	7/8	22
SZ-3-7-8mm	SC-314	SZ-7-8mm	8mm	2 1/4	57	1 3/8	35	7/8	22
SZ-3-7-10mm	SC-314	SZ-7-10mm	10mm	2 1/4	57	1 3/8	35	7/8	22

1/2" Square Drive

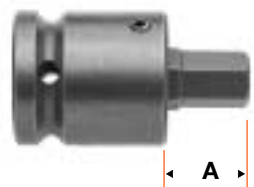

Complete	Part Number		Hex Size	Overall Length		Length of Insert		Bit Length (A)	
	Adapter Only	Insert Only		In.	mm	In.	mm	In.	mm
SZ-5-7-3mm	SC-514	SZ-7-3mm	3mm	2 1/2	63	1 3/8	35	7/8	22
SZ-5-7-4mm	SC-514	SZ-7-4mm	4mm	2 1/2	63	1 3/8	35	7/8	22
SZ-5-7-5mm	SC-514	SZ-7-5mm	5mm	2 1/2	63	1 3/8	35	7/8	22
SZ-5-7-6mm	SC-514	SZ-7-6mm	6mm	2 1/2	63	1 3/8	35	7/8	22
SZ-5-7-8mm	SC-514	SZ-7-8mm	8mm	2 1/2	63	1 3/8	35	7/8	22
SZ-5-7-10mm	SC-514	SZ-7-10mm	10mm	2 1/2	63	1 3/8	35	7/8	22
SZ-5-7-12mm	SC-514	SZ-7-12mm	12mm	2 1/2	63	1 3/8	35	7/8	22
SZ-5-7-14mm	SC-514	SZ-7-14mm	14mm	2 1/2	63	1 3/8	35	15/16	24
SZ-5-10-14mm	RP-520	SZ-10-14mm	14mm	2 1/2	63	1 9/16	40	29/32	23
SZ-5-10-17mm	RP-520	SZ-10-17mm	17mm	2 1/2	63	1 9/16	40	29/32	23
SZ-5-10-19mm	RP-520	SZ-10-19mm	19mm	2 1/2	63	1 9/16	40	29/32	23

3/4" Square Drive

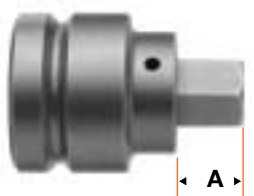

Complete	Part Number		Hex Size	Overall Length		Length of Insert		Bit Length (A)	
	Adapter Only	Insert Only		In.	mm	In.	mm	In.	mm
SZ-7-10-10mm	RP-720	SZ-10-10mm	10mm	2 1/2	64	1 9/16	40	29/32	23
SZ-7-10-12mm	RP-720	SZ-10-12mm	12mm	2 1/2	64	1 9/16	40	29/32	23
SZ-7-10-14mm	RP-720	SZ-10-14mm	14mm	2 1/2	64	1 9/16	40	29/32	23
SZ-7-10-17mm	RP-720	SZ-10-17mm	17mm	2 1/2	64	1 9/16	40	29/32	23

1" Square Drive

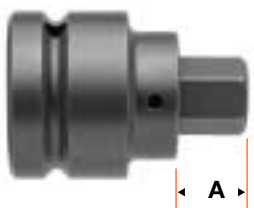

Complete	Part Number		Hex Size	Overall Length		Length of Insert		Bit Length (A)	
	Adapter Only	Insert Only		In.	mm	In.	mm	In.	mm
SZ-8-14-17mm	RP-828	SZ-14-17mm	17mm	3 5/16	84	2	51	1 1/8	29
SZ-8-14-19mm	RP-828	SZ-14-19mm	19mm	3 5/16	84	2	51	1 1/8	29
SZ-8-14-22mm	RP-828	SZ-14-22mm	22mm	3 5/16	84	2	51	1 1/8	29
SZ-8-14-24mm	RP-828	SZ-14-24mm	24mm	3 5/16	84	2	51	1 1/8	29
SZ-8-14-27mm	RP-828	SZ-14-27mm	27mm	3 5/16	84	2	51	1 1/8	29

Socket Head Bit and Adapter Sets



APH35M 5 piece, 3/8" square drive: 4mm, 5mm, 6mm, 8mm, 10mm



APH56M 6 piece, 1/2" square drive: 6mm, 8mm, 10mm, 12mm, 14mm, 17mm

Square Recess Bits









1/4" Hex Insert Bits



Part Number	Point Size	Nominal Size In.	Overall Length	
			In.	mm
950-0	0	1/16	1	25
950-1X 	1	3/32	1	25
950-2X 	2	1/8	1	25
950-3	3	9/64	1	25





1/4" Hex Power Drive



Part Number	Point Size	Nominal Size In.	Overall Length	
			In.	mm
954-0	0	1/16	1 15/16	49
954-A-0	0	1/16	2 3/4	70
954-C-0	0	1/16	6	152
954-1X 	1	3/32	1 15/16	49
954-A-1	1	3/32	2 3/4	70
954-B-1	1	3/32	3 1/2	89
954-C-1	1	3/32	6	152
954-2X 	2	1/8	1 15/16	49
954-A-2X 	2	1/8	2 3/4	70
954-B-2X 	2	1/8	3 1/2	89
954-C-2X 	2	1/8	6	152
954-3X 	3	9/64	1 15/16	49
954-A-3	3	9/64	2 3/4	70
954-B-3	3	9/64	3 1/2	89
954-C-3	3	9/64	6	152

1/4" Hex Power Drive – Turned Body



Part Number	Point Size	Nominal Size In.	Overall Length		Turned Length	
			In.	mm	In.	mm
1950-0	0	1/16	1 15/16	49	1 1/4	32
1951-0	0	1/16	2 3/4	70	2	51
1953-0	0	1/16	3 1/2	89	2 3/4	70
1950-1	1	3/32	1 15/16	49	1 1/4	32
1951-1	1	3/32	2 3/4	70	2	51
1953-1	1	3/32	3 1/2	89	2 3/4	70
1950-2X 	2	1/8	1 15/16	49	1 1/4	32
1951-2X 	2	1/8	2 3/4	70	2	51
1953-2X 	2	1/8	3 1/2	89	2 3/4	70
1950-3	3	9/64	1 15/16	49	1 1/4	32
1951-3	3	9/64	2 3/4	70	2	51
1953-3X 	3	9/64	3 1/2	89	2 3/4	70

Screw Size	3 & 4	5, 6, 7	8, 9, 10	12-14 1/4
Square Point Size	0	1	2	3

Quad-rex bits available upon request.

Clutch Head Bits



1/4" Hex Insert Bits



Standard Part Number	G-Type Part Number	Clutch Size	Overall Length	
			In.	mm
190-1	190-1G	3/32	1 1/4	32
190-2	190-2G	1/8	1 1/4	32
190-3	190-3G	5/32	1 1/4	32
190-4	190-4G	3/16	1 1/4	32
190-5	190-5G	1/4	1 1/4	32
190-7	190-7G	5/16	1 1/4	32

1/4" Hex Power Drive

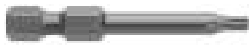

Type G power bits are available on request.

Standard Part Number	Clutch Size	Overall Length	
		In.	mm
2122	1/8	1 15/16	49
2123	5/32	1 15/16	49
2123-A	5/32	2 3/4	70
2123-B	5/32	3 1/2	89
2124	3/16	1 15/16	49
2125	1/4	1 15/16	49

Male Square Inserts for Pipe Plugs



1/4" to 1/2" Male Square











Part Number	Male Hex In.	Male Square In.	Overall Length	
			In.	mm
P-1408	7/16	1/4	1 1/4	32
P-1409	7/16	9/32	1 1/4	32
P-1410	7/16	5/16	1 1/4	32
P-1412	7/16	3/8	1 1/4	32
P-1414	7/16	7/16	1 1/4	32
P-1416	7/16	1/2	1 1/4	32
P-1418	7/16	9/16	1 1/2	38
P-2010	5/8	5/16	1 1/2	38
P-2012	5/8	3/8	1 1/2	38
P-2014	5/8	7/16	1 1/2	38
P-2016	5/8	1/2	1 1/2	38

Note: For pipe plug inserts use SC and RP bit holders found on page 51.

1/4" Hex Insert Bits





Part Number	Point Size	Overall Length	
		In.	mm
212-0	0	1	25
212-1	1	1	25
212-2 	2	1	25
212-3 	3	1	25
212-4 	4	1	25
212-5 	5	1	25
212-6 	6	1	25
212-8 	8	1	25
212-10 	10	1	25
212-1/4 	1/4	1	25

1/4" Hex Insert Bits – ACR®



Available with ACR® ribs for removal only



Part Number	Point Size	Overall Length	
		In.	mm
212-6-ACR	6	1 1/4	32
212-8-ACR 	8	1 1/4	32
212-10-ACR 	10	1 1/4	32
212-1/4-ACR	1/4	1 1/4	32

5/16" Hex Insert Bits



Part Number	Point Size	Overall Length	
		In.	mm
212-8A	8	1 1/4	32
212-10A	10	1 1/4	32
212-1/4A 	1/4	1 1/4	32
212-5/16A 	5/16	1 1/4	32
212-3/8A	3/8	1 1/4	32

5/16" Hex Insert Bits – ACR®











Available with ACR® ribs for removal only



Part Number	Point Size	Overall Length	
		In.	mm
212-1/4A-ACR	1/4	1 1/4	32
212-5/16A-ACR	5/16	1 1/4	32

1/4" Hex Power Drive



Part Number	Point Size	Overall Length	
		In.	mm
170-0	0	1 1/4	32
273A-0	0	1 13/16	46
273-0	0	1 15/16	49
273B-0	0	2 3/4	70
265-0	0	3 1/2	89
265A-0	0	6	152
170-1	1	1 1/4	32
273A-1	1	1 13/16	46
273-1	1	1 15/16	49
273B-1	1	2 3/4	70
265-1	1	3 1/2	89
265A-1	1	6	152
170-2	2	1 1/4	32
273A-2	2	1 13/16	46
273-2	2	1 15/16	49
273B-2	2	2 3/4	70
265-2	2	3 1/2	89
265A-2	2	6	152
170-3	3	1 1/4	32
273A-3	3	1 13/16	46
273-3	3	1 15/16	49
273B-3	3	2 3/4	70
265-3	3	3 1/2	89
265A-3	3	6	152
170-4 	4	1 1/4	32
273A-4	4	1 13/16	46
273-4	4	1 15/16	49
273B-4	4	2 3/4	70
265-4	4	3 1/2	89
265A-4	4	6	152
170-5 	5	1 1/4	32
273-5	5	1 15/16	49
273B-5	5	2 3/4	70
265-5	5	3 1/2	89
265A-5	5	6	152
170-6 	6	1 1/4	32
170-6-ACR*	6	1 1/4	32
273A-6	6	1 13/16	46
273-6	6	1 15/16	49
273B-6	6	2 3/4	70
265-6	6	3 1/2	89
265A-6	6	6	152
170-8 	8	1 1/4	32
170-8-ACR*	8	1 1/4	32
273A-8	8	1 13/16	46
273-8 	8	1 15/16	49
273B-8 	8	2 3/4	70
265-8	8	3 1/2	89
265A-8	8	6	152
170-10 	10	1 1/4	32
170-10-ACR* 	10	1 1/4	32
273A-10	10	1 13/16	46
273-10 	10	1 15/16	49
273B-10	10	2 3/4	70
265-10	10	3 1/2	89
265A-10	10	6	152
170-1/4B 	1/4	1 1/4	32
170-5/16B 	5/16	1 1/4	32
170-3/8B	3/8	1 1/4	32

*Feature ACR® anti-camout ribs.

 Refer to Page iv for description of Rapid Select.

5/16" Hex Power Drive



Part Number	Point Size	Overall Length	
		In.	mm
170-8A	8	1 1/4	32
170-10A	10	1 1/4	32
170-1/4A	1/4	1 1/4	32
170-5/16A	5/16	1 1/4	32
170-3/8A	3/8	1 1/4	32

7/16" Hex Power Drive



Part Number	Point Size	Overall Length	
		In.	mm
170-1/4 	1/4	1 1/4	32
265-1/4	1/4	3 1/2	89
265A-1/4	1/4	6	152
170-5/16	5/16	1 1/4	32
265-5/16	5/16	3 1/2	89
265A-5/16	5/16	6	152
170-3/8	3/8	1 1/4	32
170-3/8C	3/8	1 1/4	32
265A-3/8	3/8	6	152
170-7/16	7/16	1 1/4	32
170-7/16C	7/16	1 1/4	32
265-7/16	7/16	3 1/2	89
265A-7/16	7/16	6	152

7/16" Hex Power Drive – ACR®

Available with ACR® ribs for removal only



Part Number	Point Size	Overall Length	
		In.	mm
170-1/4-ACR	1/4	1 1/4	32
170-5/16-ACR	5/16	1 1/4	32





5/8" Hex Power Drive



Part Number	Point Size	Overall Length	
		In.	mm
170-1/2	1/4	1 1/4	32
170-9/16	9/16	1 1/4	32
170-5/8	5/8	1 1/4	32

1/4" Hex Insert Bits



Part Number	Recess Size	Screw Size Tension Head	Screw Size Shear Head	Overall Length	
				In.	mm
TWD-0	0	0-80	-	1	25
TWD-1	1	2-56	4-40	1	25
TWD-2 	2	4-40	6-32	1	25
TWD-3 	3	6-32	8-32	1	25
TWD-4 	4	8-32	10-32	1	25
TWD-5 	5	10-32	1/4-28	1	25
TWD-6 	6	1/4	5/16	1	25
TWD-7	7	5/16	3/8	1	25

1/4" Hex Insert Bits – ACR®

Available with ACR® ribs for removal only



Part Number	Recess Size	Screw Size Tension Head	Screw Size Shear Head	Overall Length	
				In.	mm
TWD-4-ACR	4	8-32	10-32	1	25
TWD-5-ACR	5	10-32	1/4-28	1	25



5/16" Hex Insert Bit



Part Number	Recess Size	Screw Size Tension Head	Screw Size Shear Head	Overall Length	
				In.	mm
TWE-4	4	8-32	10-32	1 1/4	32
TWE-5	5	10-32	1/4-28	1 1/4	32

1/4" Hex Power Drive



Part Number	Recess Size	Screw Size Tension Head	Screw Size Shear Head	Overall Length	
				In.	mm
TW-0	0	0-80	-	1 1/4	32
TW-1	1	2-56	4-40	1 1/4	32
TW-2	2	4-40	6-32	1 1/4	32
TW-3 	3	6-32	8-32	1 1/4	32
TW-4 	4	8-32	10-32	1 1/4	32
TW-5 	5	10-32	1/4-28	1 1/4	32
TWB-6	6	1/4-28	5/16-24	1 1/4	32
TWB-7	7	5/16-24	3/8-24	1 1/4	32
TWB-8	8	3/8-24	7/16-20	1 1/4	32

Tri-Wing® and ACR® are registered trademarks of the Phillips Screw Company.

 Refer to Page iv for description of Rapid Select.

1/4" Hex Power Drive – ACR®



Part Number	Recess Size	Screw Size Tension Head	Screw Size Shear Head	Overall Length In.	Overall Length mm
TW-5-ACR	5	10-32	1/4-28	1 1/4	32

5/16" Hex Power Drive



Part Number	Recess Size	Screw Size Tension Head	Screw Size Shear Head	Overall Length In.	Overall Length mm
TWA-4	4	8-32	10-32	1 1/4	32
TWA-5	5	10-32	1/4-28	1 1/4	32
TWA-6	6	1/4-28	5/16-24	1 1/4	32
TWA-7	7	5/16-24	3/8-24	1 1/4	32
TWA-8	8	3/8-24	7/16-20	1 1/4	32

7/16" Hex Power Drive



Part Number	Recess Size	Screw Size Tension Head	Screw Size Shear Head	Overall Length In.	Overall Length mm
TW-6	6	1/4-28	5/16-24	1 1/4	32
TW-7	7	5/16-24	3/8-24	1 1/4	32
TW-8	8	3/8-24	7/16-20	1 1/4	32

5/8" Hex Power Drive



Part Number	Recess Size	Screw Size Tension Head	Screw Size Shear Head	Overall Length In.	Overall Length mm
TW-9	9	7/16-20	1/2-20	1 1/4	32
TW-10	10	1/2-20	9/16-18	1 1/4	32
TW-11	11	9/16-18	5/8-18	1 1/4	32
TW-12	12	5/8-18	3/4-16	1 1/4	32
TW-13	13	3/4-16	7/8-14	2 1/2	64

3/4" Hex Power Drive



Part Number	Recess Size	Screw Size Tension Head	Screw Size Shear Head	Overall Length In.	Overall Length mm
TW-14	14	7/8-14	1-12	3	76
TW-15	15	1-12	-	3	76



1/4" Square Drive Insert Bits



Part Number	Recess	Overall Length In.	Body Diameter In.	Blade Thickness In.	Blade Width In.
HTS-0	0	1	1/2	.029	.167
HTS-1	1	1	1/2	.049	.274
HTS-2	2	1	1/2	.059	.295
HTS-3	3	1	1/2	.059	.377
HTS-4	4	1	1/2	.073	.502

3/8" Square Drive Insert Bits



Part Number	Recess	Overall Length In.	Body Diameter In.	Blade Thickness In.	Blade Width In.
HTS-3A	3	1	3/4	.059	.377
HTS-4A	4	1	3/4	.073	.502
HTS-5	5	1 1/4	3/4	.079	.629
HTS-6	6	1 1/4	3/4	.095	.745

1/2" Square Drive Insert Bits



Part Number	Recess	Overall Length In.	Body Diameter In.	Blade Thickness In.	Blade Width In.
HTS-7	7	1 5/8	1	.112	.884
HTS-8	8	1 5/8	1	.142	.995
HTS-9	9	1 5/8	1 1/4	.162	1.136
HTS-10	10	1 5/8	1 1/4	.182	1.250
HTS-12	12	2 3/8	1 1/4	.216	1.500

1/4" Hex Insert Bits



Part Number	Recess	Overall Length In.	Body Diameter In.	Blade Thickness In.	Blade Width In.
HTN-B-1	1	1 1/4	9/32	.049	.274
HTN-B-2	2	1 1/4	5/16	.059	.295
HTN-B-3	3	1 1/4	3/8	.059	.377
HTN-B-4	4	1 1/4	1/2	.073	.502

Nominal Screw Size	0	1	2	3	4	5	6	8	10	1/4	5/16	3/8	7/16	1/2	9/16	5/8	3/4
Hi-Torque Recess	0	0	0	1	1	1	1	2	3	4	5	6	7	8	9	10	12

Triple Square Bits



1/4" Hex Insert Bits



Part Number	Point Size	Overall Length	
		In.	mm
440-TSQ-4M	4mm	1	25
440-TSQ-5M	5mm	1	25
440-TSQ-6M	6mm	1	25
440-TSQ-8M	8mm	1	25
440-TSQ-10M	10mm	1	25

5/16" Hex Insert Bits



Part Number	Point Size	Overall Length	
		In.	mm
480-TSQ-4M	4mm	1 1/4	32
480-TSQ-5M	5mm	1 1/4	32
480-TSQ-6M	6mm	1 1/4	32
480-TSQ-8M	8mm	1 1/4	32
480-TSQ-10M	10mm	1 1/4	32
480-TSQ-12M	12mm	1 1/4	32
480-TSQ-14M	14mm	1 1/4	32

1/4" Hex Power Drive



Part Number	Point Size	Overall Length	
		In.	mm
49-TSQ-4M	4mm	2	50
49-TSQ-5M	5mm	2	50
49-TSQ-6M	6mm	2	50
49-TSQ-8M	8mm	2	50
49-TSQ-10M	10mm	2	50
49-TSQ-12M	12mm	2	50

7/16" Hex Power Drive



Part Number	Point Size	Overall Length	
		In.	mm
48-TSQ-4M	4mm	3 1/2	88
48-TSQ-5M	5mm	3 1/2	88
48-TSQ-6M	6mm	3 1/2	88
48-TSQ-8M	8mm	3 1/2	88
48-TSQ-10M	10mm	3 1/2	88
48-TSQ-12M	12mm	3 1/2	88
48-TSQ-14M	14mm	3 1/2	88



A series of horizontal lines for writing notes, spanning the width of the page.

APEX® Solutions

Does Apex offer magnetic bit holders?

Bit holders, like this Apex M-490, let you use a variety of insert bits in power tool applications. You get economy and flexibility – and fasteners can be magnetically held to the bit.

(See page 52)



Do Apex quick-release bit holders hold bits securely?

A quick-release bit holder allows fast, easy insert bit changes while assuring that bits stay securely in the bit holder. Simply pull back on the knurled sleeve to release the bit.

(See pages 53)



Does Apex offer quick release chucks?

Apex has a complete line of quick release chucks that provide fast and easy power bit changes.

(See page 56)



Bit Holders



1/4" Hex Drive for 1/4" Hex Inserts



Non-magnetic

Part Number	Overall Length		
	In.	mm	
490	2 1/8	54	
490-3	3	76	
490-4	4	102	
490-5	5	127	
490-6	6	152	
490-8	8	203	
490-10	10	254	
M-490-2	2	51	Magnetic
M-490	2 31/32	75	Magnetic
M-497	3 3/32	79	Magnetic; 3/8" (9.5mm) reduced diameter
M-490-4	4	102	Magnetic
M-490-6	6	152	Magnetic
M-490-8	8	203	Magnetic
M-490-10	10	254	Magnetic
M-490-12	12	304	Magnetic
M-44-90	3 1/4	83	Magnetic; for Flip-Tip™ reversible bits
M-495	2 7/8	73	Magnetic; 3/8" (9.5mm) turned shank
M-495-5	5	127	Magnetic; 3/8" (9.5mm) turned shank
RM-490	2 7/8	73	Magnetic; nose piece only, #490-RN
RM-490-4	4	102	Magnetic; nose piece only, #490-RN
RM-490-6	6	152	Magnetic; nose piece only, #490-RN
M-490-2-OR	2	51	Magnetic; with O-Ring retainer
M-490-OR	3	76	Magnetic; with O-Ring retainer

Bit Holders

1/4" Hex Drive for 1/4" Hex Inserts, Quick Release



Part Number	Overall Length		
	In.	mm	
QR-M-490-2	2	51	Magnetic; quick release
QR-M-490-A	2 29/32	74	Magnetic; quick release
QR-M-490-A6	6	152	Magnetic; quick release
QR-M-490-200M	7 7/8	200	Magnetic; quick release

1/4" Hex Drive for 5/16" Hex Inserts



Part Number	Overall Length		
	In.	mm	
498	2 3/8	60	
M-498	3 1/16	78	Magnetic

5/16" Hex Drive



Part Number	Overall Length		
	In.	mm	
630	1 13/16	46	For 1/4" hex inserts
M-630	3	76	For 1/4" hex inserts; magnetic
638	2 1/2	64	For 5/16" hex inserts
M-638	3 3/32	79	For 5/16" hex inserts; magnetic

5/16" Buckeye-Desoutter for 1/4" Hex Inserts



Part Number	Overall Length		
	In.	mm	
610	2	51	
M-610	3 3/16	81	Magnetic

Bit Holders



7/16" Hex Drive



Part Number	Overall Length		
	In.	mm	
488	2 3/4	70	For 1/4" hex inserts
M-488 	3 1/16	78	For 1/4" hex inserts; magnetic
480	2 3/4	70	For 5/16" hex inserts
M-480	3 5/16	84	For 5/16" hex inserts; magnetic
M-480-6	6	152	For 5/16" hex inserts; magnetic

9/32" 130-A Yankee Type for 1/4" Hex Inserts



Part Number	Overall Length		
	In.	mm	
450	2 1/4	57	
M-450	3 3/8	86	Magnetic

5/16" 131-A Yankee Type for 1/4" Hex Inserts



Part Number	Overall Length		
	In.	mm	
460	2 1/4	57	
M-460	3 3/8	86	Magnetic

7/32" 135-A Yankee Type for 1/4" Hex Inserts



Part Number	Overall Length		
	In.	mm	
470	2 1/4	57	
M-470	3 3/8	86	Magnetic

1/4"-20 Screw Shank for 1/4" Hex Inserts



Part Number	Overall Length		
	In.	mm	
510	1 1/16	30	
M-510	2 11/32	60	Magnetic

1/4"-24 Screw Shank for 1/4" Hex Inserts



Part Number	Overall Length		
	In.	mm	
400-BH	1 1/8	29	
M-400	2 13/32	61	Magnetic

Bit Holders

1/4" Female Square Drive



Part Number	Overall Length		
	In.	mm	
825	1	25	For 1/4" hex inserts
M-825	2 9/32	58	For 1/4" hex inserts; magnetic
820	23/32	18	For 1/4" square inserts

3/8" Female Square Drive

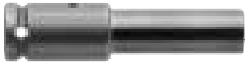

Part Number	Overall Length		
	In.	mm	
838	1 1/2	38	For 1/4" hex inserts
M-838	2 23/32	69	For 1/4" hex inserts; magnetic
835	1 1/2	38	For 5/16" hex inserts
M-835	2 3/4	70	For 5/16" hex inserts; magnetic
830	1 1/2	38	For 5/16" square inserts

1/2" Female Square Drive



Part Number	Overall Length		
	In.	mm	
858	1 3/4	45	For 1/4" hex inserts
M-858	2 3/4	70	For 1/4" hex inserts; magnetic
855	1 3/4	45	For 5/16" hex inserts
M-855	2 3/4	70	For 5/16" hex inserts; magnetic
850	1 3/4	45	For 5/16" square inserts

Bit Holders/Adapters with Set Screw or Thru Hole

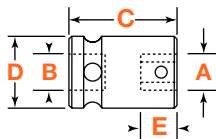

Set Screw Lock	Part Number		Hex Opening (A) In.	Square Drive (B) In.	Overall Length (C)		Body Diameter (D)		Opening Depth (E)	
	Spring Pin Retainer	Spring Pin Only			In.	mm	In.	mm	In.	mm
	SC-108	-	-	1/4	1/4	1 1/4	32	3/4	19	5/8 16
	SC-308	-	-	1/4	3/8	1 1/2	38	3/4	19	5/8 16
	SC-508	-	-	1/4	1/2	1 1/2	38	7/8	22	5/8 16
	SC-114	-	-	7/16	1/4	1	25	3/4	19	17/32 13
	SC-314	RP-314	21-S-156-0750	7/16	3/8	1 3/8	35	3/4	19	17/32 13
	SC-514	RP-514	21-S-156-0937	7/16	1/2	1 5/8	41	15/16	24	17/32 13
	SC-614	RP-614	21-S-156-0375	7/16	5/8	1 3/4	46	1 1/4	32	17/32 13
	SC-520	RP-520	21-S-187-1125	5/8	1/2	1 1/2	38	1 1/8	29	11/16 17
	SC-620	RP-620		5/8	5/8	1 1/2	38	1 1/4	32	11/16 17
	SC-720	RP-720	21-S-187-1500	5/8	3/4	1 11/16	43	1 1/2	38	11/16 17
	SC-820	RP-820	21-S-187-1375	5/8	1	2 1/8	54	2 1/8	54	11/16 17
	SC-724	RP-724	21-S-187-1500	3/4	3/4	2	51	1 5/8	42	7/8 22
	SC-728	RP-728	21-S-187-1625	7/8	3/4	2	51	1 5/8	42	57/64 23
	SC-828	RP-828	21-S-187-1625	7/8	1	2 1/8	54	2 1/8	54	5/8 23

Note: Use SC and RP bit holders with socket head inserts (page 36) and pipe plug inserts (page 40). Can be used with power bits.

Bit Holders



Female Threaded Drive, Quick Releasing Chucks



Part Number	Female Thread	Hex Opening In.	Overall Length In.	mm	Overall Diameter In.	mm	Opening Depth In.	mm
QRA-08	3/8"-24	1/4	1 3/4	45	3/4	19	61/64	24
QRA-14	3/8"-24	7/16	2	51	1 1/4	32	1 1/16	27
QRF-08	1/2"-20	1/4	1 3/4	45	3/4	19	61/64	24
QRF-14	1/2"-20	7/16	2	51	1 1/4	32	1 1/16	27
QRF-20	1/2"-20	5/8	2 5/8	67	1 5/8	41	1 1/2	38

Female Square Drive, Quick Releasing Chucks

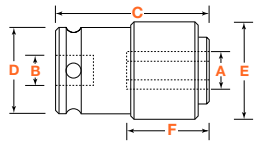

Part Number	Hex Opening (A)	Square Drive (B)	Overall Length (C)		Body Diameter (D)		Sleeve Diameter (E)		Opening Depth (F)	
	In.	In.	In.	mm	In.	mm	In.	mm	In.	mm
QR-108	1/4	1/4	1 1/2	38	3/4	19	3/4	19	61/64	24
QR-308	1/4	3/8	1 3/4	45	3/4	19	3/4	19	61/64	24
QR-508	1/4	1/2	2 1/8	54	7/8	22	3/4	19	61/64	24
QR-314	7/16	3/8	2	51	1	25	1 1/4	32	1 3/32	28
QR-514	7/16	1/2	2 1/8	54	1	25	1 1/4	32	1 1/16	27
QR-614	7/16	5/8	2 1/8	54	1 1/4	32	1 1/4	32	1 1/16	27
QR-714	7/16	3/4	2 3/8	60	1 1/2	38	1 1/4	32	1 1/16	27
QR-520	5/8	1/2	2 5/8	67	1 1/2	38	1 5/8	41	1 1/2	38
QR-620	5/8	5/8	2 5/8	67	1 1/2	38	1 5/8	41	1 1/2	38
QR-720	5/8	3/4	3 1/8	79	1 1/2	38	1 5/8	41	1 1/2	38
QR-820	5/8	1	3 1/4	83	2 1/8	54	1 5/8	41	1 1/2	38
QR-824	3/4	1	3 3/4	95	2	51	1 7/8	48	1 5/8	41

Hand Drivers

Drivers with Self-Contained Insert Bits



Part No.	Female Hex Size	Overall Length In.	mm	Blade Projection In.	mm	
M-15-SC	1/4	8 1/2	216	4 3/8	111	Phillips #1, #2, #3; Slotted 4F-5R, 10F-12R; hollow handle.
M-15-SC-A	1/4	8 1/2	216	4 3/8	111	Without bits; hollow handle.

Replaceable Bit Drivers



Part No.	Female Hex Size	Overall Length In.	mm	Blade Projection In.	mm
1505-P	1/4	1 7/8	48	-	-
1510-P	1/4	2 3/4	70	7/8	22
1555-P	5/16	2 7/8	73	7/8	22
1500-P	1/4	7 1/2	191	3 9/32	83
1550-P	5/16	10 1/2	267	6	152

Replaceable Bit Drivers – Magnetic



Part No.	Female Hex Size	Overall Length In.	mm	Blade Projection In.	mm
M-1505-P	1/4	2 3/8	60	3/8	10
M-1500-P	1/4	8 1/2	216	4 3/8	111
M-1550-P	5/16	10 1/2	267	6	152

Replaceable Socket Nut Runners



Part Number	Drive Size	Type Lock.	Overall Length In.	mm	Blade Projection In.	mm
SW-911-P	1/4" Sqr.	Pin	7 1/2	191	3	76
SW-911-BP	1/4" Sqr.	Ball	7 1/2	191	3	76
SWSC-911-C*	1/4" Sqr.	Ball	8 5/16	211	3 5/8	92

*Hollow handle with 3/16, 1/4, 5/16 and 3/8 sockets.

Industrial Bit Kit



24 Bit Kit Tool kit includes plastic carrying case with:

Magnetic hand driver and magnetic bit holder.

Phillips bits: #1, #2, #3

Slotted bits: 3F-4R, 4F-5R, 6F-8R, 8F-10R, 10F-12R

Torx® bits: T-10, T-15, T-20, T-25, T-27, T-30, T-40

Square Recess bits: 3/32", 1/8"

Hex bits: 5/64", 3/32", 7/64", 1/8", 9/64"

Pozidriv® bits: #1, #2

Pozidriv® is a registered trademark of the Phillips Screw Co. Torx® is a registered trademark of the Camcar Division of Textron.

Refer to Page iv for description of Rapid Select.

Hand Drivers







Torx® Keys



Part Number	Driver Size	A Ref.		Short Arm		Long Arm	
				In.	mm	In.	mm
71-TX-06*	T-6	.066		5/8	16	1 11/16	43
71-TX-07	T-7	.077		5/8	16	1 7/8	48
71-TX-08	T-8	.090		5/8	16	1 7/8	48
71-TX-09	T-9	.097		5/8	16	1 7/8	48
71-TX-10	T-10	.107		11/16	18	2	51
71-TX-15	T-15	.128		11/16	18	2 1/8	54
71-TX-20	T-20	.151		3/4	19	2 1/4	57
71-TX-25	T-25	.173		13/16	21	2 3/8	60
71-TX-27	T-27	.195		7/8	22	2 1/2	64
71-TX-30	T-30	.216		15/16	24	2 3/4	70
71-TX-40	T-40	.260		1 1/16	27	3	76
71-TX-45	T-45	.306		1 1/8	28	3 1/4	83
71-TX-50	T-50	.345		1 1/4	32	3 3/4	95
71-TX-55	T-55	.440		1 3/8	35	4 5/16	110

*T-6 key has Torx tip on short arm only.

Torx® Hand Drivers

Part Number	Driver Size	A Ref.		Overall Length		Blade Length	
				In.	mm	In.	mm
13-TX-06	T-6	0.066		6 3/4	171	3	76
13-TX-07	T-7	0.077		6 3/4	171	3	76
13-TX-08 	T-8	0.090		6 3/4	171	3	76
13-TX-09	T-9	0.097		6 3/4	171	3	76
13-TX-10 	T-10	0.107		6 3/4	171	3	76
13-TX-15 	T-15	0.128		6 3/4	171	3	76
13-TX-20	T-20	0.151		6 3/4	171	3	76
13-TX-25	T-25	0.173		6 3/4	171	3	76
13-TX-27	T-27	0.195		7 3/4	197	4	102
13-TX-30	T-30	0.216		7 3/4	197	4	102
13-TX-40	T-40	0.260		10 1/8	257	6	152

Hand Drivers

Torq-Set® Hand Drivers

Part Number	Screw Size	Overall Length		Blade Length	
		In.	mm	In.	mm
268P-0	0	3	76	1 1/4	32
268P-1	1	3	76	1 1/4	32
268P-2	2	6 1/4	159	3 1/8	79
268P-3	3	6 1/4	159	3 1/8	79
268P-4	4	6 1/4	159	3 1/8	79
268P-5	5	6 1/4	159	3 1/8	79
268P-6	6	7 1/2	190	4	102
268P-8	8	7 1/2	190	4	102
268P-10	10	7 1/2	190	4	102
268P-1/4	1/4	10 1/8	257	4	102

Awls



Part Number	Overall Length		Shank Diameter	
	In.	mm	In.	mm
AW-95	7 7/16	189	.307	7.8
AW-95-L	8	203	.307	7.8
AW-95-LL	8 7/8	225	.307	7.8
AW-375	9	228	.375	9.5

Use awls to line up hole and scratch mark surfaces.

Pivex™ Pivot Drivers



Part Number	Overall Length		
	In.	mm	
MQR-15PV	11.8	298	1/4" Magnetic Quick-Release Bit Holder
M-15PVH*	11.7	296	1/4" Magnetic Bit Holder, Hollow Handle with Bits
M-15PVH-A	11.7	296	1/4" Magnetic Bit Holder, Hollow Handle without Bits

*Includes Phillips #1, 2, 3 and Slotted 4F-5R, 10F-12R bits.

The Apex® Pivex™ replaceable bit hand driver has a jointed shaft that allows the handle to pivot 180°. This lets you apply five times more torque than an ordinary hand driver of the same length.

1/4" Hex Drive Nutsetters for SAE Sheet Metal Screws



6 Point



Power Drive

Part Number 6 Point	Size In.	Overall Length In.	Socket Nose Diameter In.		
DB-08	1/4	2 9/16	7/16	Non-magnetic	
DB-10	5/16	2 9/16	1/2	Non-magnetic	
DB-12	3/8	2 9/16	9/16	Non-magnetic	
MDA-08	1/4	1 3/4	7/16	Magnetic	
MDAT-08	1/4	1 3/4	3/8	Magnetic	
MDA-10	5/16	1 3/4	1/2	Magnetic	
MDA-12	3/8	1 3/4	9/16	Magnetic	
MDA-14	7/16	2	11/16	Magnetic	
MDB-08	1/4	2 9/16	7/16	Magnetic	5/16" Shank Diameter
MDB-10	5/16	2 9/16	1/2	Magnetic	5/16" Shank Diameter
MDB-12	3/8	2 9/16	9/16	Magnetic	5/16" Shank Diameter
MDB-14	7/16	2 9/16	5/8	Magnetic	5/16" Shank Diameter
MDC-08	1/4	2 9/16	7/16	Magnetic	3/8" Shank Diameter
MDC-10	5/16	2 9/16	1/2	Magnetic	3/8" Shank Diameter
MDC-12	3/8	2 9/16	9/16	Magnetic	3/8" Shank Diameter
MHM-2508	1/4	1 1/8	7/16	Magnetic	
MHM-1310	5/16	1 1/8	1/2	Magnetic	
MHM-1912	3/8	1 3/4	9/16	Magnetic	



Insert

1/4" Hex Drive Nutsetters for Metric Sheet Metal Screws

6 Point



Power Drive

Part Number 6 Point	Size mm	Overall Length mm	Socket Nose Diameter mm		
MDA-6mm	6	44.5	9.5	Magnetic	
MDA-7mm	7	44.5	11.1	Magnetic	
MDA-8mm	8	44.5	12.7	Magnetic	
MDA-10mm	10	44.5	14.3	Magnetic	
MDA-10mm-80m	10	80.0	14.3	Magnetic	
MHM-6mm	6	31.8	11.1	Magnetic	
MHM-7mm	7	31.8	11.1	Magnetic	
MHM-8mm	8	31.8	12.7	Magnetic	
MHM-10mm	10	31.8	14.3	Magnetic	



Insert

1/4" Hex Drive Nutsetters

6 Point and 6 Point Magnetic



Part Number 6 Point	Part Number Magnetic	Size In.	Overall Length In.	Socket Nose Diameter In.
6N-0806-2	M6N-0806-2	3/16	2	5/16
6N-0806-3	M6N-0806-3	3/16	3	5/16
6N-0806-4	-	3/16	4	5/16
-	M6N-0806-5	3/16	5	5/16
6N-0806-6	M6N-0806-6	3/16	6	5/16
6N-0808-2	M6N-0808-2	1/4	2	7/16
6N-0808-3	M6N-0808-3	1/4	3	7/16
6N-0808-4	M6N-0808-4	1/4	4	7/16
6N-0808-5	M6N-0808-5	1/4	5	7/16
6N-0808-6	M6N-0808-6	1/4	6	7/16
6N-0810-2	M6N-0810-2	5/16	2	1/2
6N-0810-3	M6N-0810-3	5/16	3	1/2
6N-0810-4	M6N-0810-4	5/16	4	1/2
6N-0810-5	M6N-0810-5	5/16	5	1/2
6N-0810-6	M6N-0810-6	5/16	6	1/2
6N-0811-2	M6N-0811-2	11/32	2	9/16
6N-0811-3	M6N-0811-3	11/32	3	9/16
6N-0812-2	M6N-0812-2	3/8	2	9/16
6N-0812-3	M6N-0812-3	3/8	3	9/16
6N-0812-4	M6N-0812-4	3/8	4	9/16
6N-0812-6	M6N-0812-6	3/8	6	9/16
6N-0814-2	M6N-0814-2	7/16	2	21/32
6N-0814-3	M6N-0814-3	7/16	3	21/32
6N-0814-4	M6N-0814-4	7/16	4	21/32
6N-0814-6	M6N-0814-6	7/16	6	21/32
6N-0816-2	M6N-0816-2	1/2	2	3/4
6N-0816-3	M6N-0816-3	1/2	3	3/4
6N-0818-2	M6N-0818-2	9/16	2	13/16

1/4" Hex Drive Nutsetters



6 Point Metric

Part Number 6 Point	Size mm	Overall Length mm	Socket Nose Diameter mm	
M6N-08-8M-4	8	102	12.7	Magnetic
M6N-08-8M-6	8	152	12.7	Magnetic
M6N-08-10M-4	10	102	14.3	Magnetic
M6N-08-10M-6	10	152	14.3	Magnetic
M6N-08-12M-4	12	102	19.0	Magnetic
M6N-08-12M-6	12	152	19.0	Magnetic

6 Point, Bolt Clearance

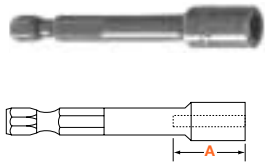

Part Number 6 Point	Size In.	Overall Length In.	Socket Nose Diameter In.	Depth of Clearance (A) In.
6B-0808	1/4	3 1/4	7/16	1 3/8
6B-0809	9/32	3 1/4	1/2	1 3/8
6B-0810	5/16	3 1/4	1/2	1 3/8
6B-0811	11/32	3 1/4	9/16	1 3/8
6B-0812	3/8	3 1/4	9/16	1 3/8
6B-0814	7/16	3 1/4	21/32	1 3/8
6B-0816	1/2	3 1/4	3/4	1 3/8
6B-0818	9/16	3 1/4	13/16	1 3/8
6B-0820	5/8	3 1/4	7/8	1 3/8

See bolt clearance Tool Tip page 73.

7/16" Hex Drive Nutsetters

6 Point



Part Number 6 Point	Size In.	Overall Length In.	Socket Nose Diameter In.
6N-1410-3	5/16	3	9/16
6N-1412-2	3/8	2	9/16
6N-1412-3	3/8	3	9/16
6N-1414-3	7/16	3	3/4
6N-1416-3	1/2	3	13/16
6N-1416-4	1/2	4	13/16
6N-1418-3	9/16	3	7/8
6N-1418-4	9/16	4	7/8
6N-1418-6	9/16	6	7/8
6N-1418-8	9/16	8	7/8
6N-1420-3	5/8	3	1
6N-1420-6	5/8	6	1
6N-1424-3	3/4	3	1 1/8
6N-1424-6	3/4	6	1 1/8

5/8" Hex Drive Nutsetters

6 Point



Part Number 6 Point	Size In.	Overall Length In.	Socket Nose Diameter In.
6N-2028-4	7/8	4	1 3/8
6N-2036-4	1 1/8	4	1 5/8

Hex Extensions



Male Hex Drive with 1/4" Male Square



Part Number	Hex Drive In.	Type of Lock	Overall Length	
			In.	mm
EX-250	1/4	Pin	1 3/8	35
EX-250-B	1/4	Ball	1 3/8	35
EX-250-2	1/4	Pin	2	51
EX-250-B-2	1/4	Ball	2	51
EX-250-3	1/4	Pin	3	76
EX-250-B-3	1/4	Ball	3	76
EX-250-4	1/4	Pin	4	102
EX-250-B-4	1/4	Ball	4	102
EX-250-5	1/4	Pin	5	127
EX-250-B-5	1/4	Ball	5	127
EX-250-6	1/4	Pin	6	152
EX-250-B-6	1/4	Ball	6	152
EX-250-8	1/4	Pin	8	203
EX-250-B-8	1/4	Ball	8	203
EX-250-12	1/4	Pin	12	305
EX-250-B-12	1/4	Ball	12	305
EX-262	5/16	Pin	1 1/2	38
EX-262-B	5/16	Ball	1 1/2	38
EX-262-2	5/16	Pin	2	51
EX-262-B-2	5/16	Ball	2	51
EX-262-3	5/16	Pin	3	76
EX-262-4	5/16	Pin	4	102
EX-262-B-4	5/16	Ball	4	102
EX-262-6	5/16	Pin	6	152
EX-262-B-6	5/16	Ball	6	152
EX-251	7/16	Pin	1 3/8	35
EX-251-B	7/16	Ball	1 3/8	35
EX-251-2	7/16	Pin	2	51
EX-251-B-2	7/16	Ball	2	51
EX-251-3	7/16	Pin	3	76
EX-251-B-3	7/16	Ball	3	76
EX-251-4	7/16	Pin	4	102
EX-251-B-4	7/16	Ball	4	102
EX-251-6	7/16	Pin	6	152
EX-251-8	7/16	Pin	8	203
EX-251-10	7/16	Pin	10	254

Hex Extensions



Male Hex Drive with 3/8" Male Square



Part Number	Hex Drive In.	Type of Lock	Overall Length	
			In.	mm
EX-370	1/4	Pin	1 5/8	41
EX-370-B	1/4	Ball	1 5/8	41
EX-370-2	1/4	Pin	2	51
EX-370-B-2	1/4	Ball	2	51
EX-370-3	1/4	Pin	3	76
EX-370-B-3	1/4	Ball	3	76
EX-370-4	1/4	Pin	4	102
EX-370-B-4	1/4	Ball	4	102
EX-370-5	1/4	Pin	5	127
EX-370-6	1/4	Pin	6	152
EX-370-B-6	1/4	Ball	6	152
EX-370-8	1/4	Pin	8	203
EX-370-B-8	1/4	Ball	8	203
EX-370-10	1/4	Pin	10	254
EX-370-B-10	1/4	Ball	10	254
EX-380	5/16	Pin	1 1/2	38
EX-380-B	5/16	Ball	1 1/2	38
EX-380-2	5/16	Pin	2	51
EX-380-B-2	5/16	Ball	2	51
EX-380-3	5/16	Pin	3	76
EX-380-4	5/16	Pin	4	102
EX-380-6	5/16	Pin	6	152
EX-371	7/16	Pin	1 3/4	45
EX-371-B	7/16	Ball	1 3/4	45
EX-371-2	7/16	Pin	2	51
EX-371-B-2	7/16	Ball	2	51
EX-371-2 3/4	7/16	Pin	2 3/4	70
EX-371-3	7/16	Pin	3	76
EX-371-B-3	7/16	Ball	3	76
EX-371-4	7/16	Pin	4	102
EX-371-B-4	7/16	Ball	4	102
EX-371-5	7/16	Pin	5	127
EX-371-6	7/16	Pin	6	152
EX-371-B-6	7/16	Ball	6	152
EX-371-8	7/16	Pin	8	203
EX-371-10	7/16	Pin	10	254
EX-371-12	7/16	Pin	12	305
EX-371-15	7/16	Pin	15	381

Hex Extensions



Male Hex Drive with 1/2" Male Square



Part Number	Hex Drive In.	Type of Lock	Overall Length	
			In.	mm
EX-500-2	1/4	Pin	2	51
EX-500-B-2	1/4	Ball	2	51
EX-500-3	1/4	Pin	3	76
EX-500-B-3	1/4	Ball	3	76
EX-500-4	1/4	Pin	4	102
EX-500B-4	1/4	Ball	4	102
EX-500-6	1/4	Pin	6	152
EX-500-B-6	1/4	Ball	6	152
EX-512-2	5/16	Pin	2	51
EX-512-B-2	5/16	Ball	2	51
EX-512-3	5/16	Pin	3	76
EX-512-B-4	5/16	Ball	4	102
EX-501-2	7/16	Pin	2 1/8	54
EX-501-B-2	7/16	Ball	2 1/8	54
EX-501-3	7/16	Pin	3	76
EX-501-B-3	7/16	Ball	3	76
EX-501-4	7/16	Pin	4	102
EX-501-B-4	7/16	Ball	4	102
EX-501-5	7/16	Pin	5	127
EX-501-B-5	7/16	Ball	5	127
EX-501-6	7/16	Pin	6	152
EX-501-B-6	7/16	Ball	6	152
EX-501-8	7/16	Pin	8	203
EX-501-B-8	7/16	Ball	8	203
EX-501-10	7/16	Pin	10	254
EX-501-B-10	7/16	Ball	10	254
EX-501-12	7/16	Pin	12	305
EX-501-B-12	7/16	Ball	12	305
EX-501-15	7/16	Pin	15	381
EX-502	5/8	Pin	2	51
EX-502-B	5/8	Ball	2	51
EX-502-3	5/8	Pin	3	76
EX-502-B-3	5/8	Ball	3	76
EX-502-4	5/8	Pin	4	102
EX-502-B-4	5/8	Ball	4	102
EX-502-5	5/8	Pin	5	127
EX-502-6	5/8	Pin	6	152
EX-502-8	5/8	Pin	8	203

Extensions

Male Hex Drive with 5/8" Male Square



Part Number	Hex Drive In.	Type of Lock	Overall Length	
			In.	mm
EX-620-3	7/16	Pin	3	76
EX-620-6	7/16	Pin	6	152
EX-621-3	5/8	Pin	3	76
EX-621-B-3	5/8	Ball	3	76
EX-621-4	5/8	Pin	4	102
EX-621-6	5/8	Pin	6	152
EX-621-8	5/8	Pin	8	203

Male Hex Drive with 3/4" Male Square



Part Number	Hex Drive In.	Type of Lock	Overall Length	
			In.	mm
EX-757-3	7/16	7/32 Drill Hole	3	76
EX-757-B-3	7/16	Ball	3	76
EX-758-4	5/8	7/32 Drill Hole	4	102
EX-758-B-4	5/8	Ball	4	102
EX-758-6	5/8	7/32 Drill Hole	6	152
EX-758-B-6	5/8	Ball	6	152
EX-758-9	5/8	7/32 Drill Hole	9	229
EX-759-4	3/4	7/32 Drill Hole	4	102

Threaded Screw Shank



Part Number	Male Square In.	Male Thread In.	Overall Length		Body Diameter	
			In.	mm	In.	mm
TH-256	1/4	1/4-28	1 5/8	41	7/16	11
TH-376	3/8	1/4-28	1 5/8	41	1/2	13
TH-250	1/4	1/4-24	1 5/8	41	7/16	11
TH-370	3/8	1/4-24	1 3/4	45	1/2	13
TH-252	1/4	1/4-20	1 3/4	45	7/16	11
TH-372	3/8	1/4-20	1 3/4	45	1/2	13
TH-254	1/4	10-32	1 3/4	45	3/8	10

Morse Taper Shank











Part Number	Male Square In.	Morse Taper	Type of Lock	Overall Length	
				In.	mm
MT-503	1/2	3	Pin	6	152
MT-752	3/4	2	7/32 Drill Hole	6	152
MT-753	3/4	3	7/32 Drill Hole	6	152
MT-754	3/4	4	7/32 Drill Hole	7	178

1/4" Male Hex Universal Wrenches, SAE

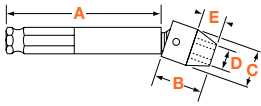

6 Point, Standard and Tension Type – Extension



	Part Number Standard	Part Number Tension	Hex Opening In.	Shank Length (A) In.	Socket Length (B) In.	Socket Diameter (C) In.	Nose End Diameter (D) In.	Clearance Depth (E) In.
	KC-25-3	-	1/4	3	3/4	5/8	3/8	3/8
	KC-25-4	-	1/4	4	3/4	5/8	3/8	3/8
	KC-25-6 	KS-25-6	1/4	6	3/4	5/8	3/8	3/8
	KC-25-9	KS-25-9	1/4	9	3/4	5/8	3/8	3/8
	KC-25-12	KS-25-12	1/4	12	3/4	5/8	3/8	3/8
	KC-26-3	-	5/16	3	3/4	5/8	7/16	3/8
	KC-26-4	-	5/16	4	3/4	5/8	7/16	3/8
	KC-26-6 	KS-26-6	5/16	6	3/4	5/8	7/16	3/8
	KC-26-9	KS-26-9	5/16	9	3/4	5/8	7/16	3/8
	KC-26-12	KS-26-12	5/16	12	3/4	5/8	7/16	3/8
	KC-100-3	-	5/16	3	3/4	3/4	7/16	5/16
	KC-100-6	KS-100-6	5/16	6	3/4	3/4	7/16	5/16
	-	KS-100-9	5/16	9	3/4	3/4	7/16	5/16
	KC-100-12	-	5/16	12	3/4	3/4	7/16	5/16
	KC-27-3	-	11/32	3	3/4	5/8	1/2	3/8
	KC-27-6	KS-27-6	11/32	6	3/4	5/8	1/2	3/8
	KC-27-12	-	11/32	12	3/4	5/8	1/2	3/8
	KC-101-3	-	11/32	3	3/4	3/4	15/32	5/16
	KC-101-6	KS-101-6	11/32	6	3/4	3/4	15/32	5/16
	KC-28-3	-	3/8	3	13/16	5/8	9/16	7/16
	KC-28-4	-	3/8	4	13/16	5/8	9/16	7/16
	KC-28-6 	KS-28-6	3/8	6	13/16	5/8	9/16	7/16
	KC-28-9	KS-28-9	3/8	9	13/16	5/8	9/16	7/16
	KC-28-12	KS-28-12	3/8	12	13/16	5/8	9/16	7/16
	KC-102-3	-	3/8	3	13/16	3/4	9/16	3/8
	KC-102-6	KS-102-6	3/8	6	13/16	3/4	9/16	3/8
KC-102-9	KS-102-9	3/8	9	13/16	3/4	9/16	3/8	
KC-29-3	-	7/16	3	7/8	5/8	5/8	1/2	
KC-29-6 	KS-29-6	7/16	6	7/8	5/8	5/8	1/2	
-	KS-29-9	7/16	9	7/8	5/8	5/8	1/2	
KC-29-12	-	7/16	12	7/8	5/8	5/8	1/2	
KC-103-3	-	7/16	3	15/16	3/4	5/8	1/2	
KC-103-6	KS-103-6	7/16	6	15/16	3/4	5/8	1/2	
KC-103-9	KS-103-9	7/16	9	15/16	3/4	5/8	1/2	
KC-30-3	-	1/2	3	7/8	11/16	11/16	1/2	
KC-30-4	-	1/2	4	7/8	11/16	11/16	1/2	
KC-30-6 	KS-30-6	1/2	6	7/8	11/16	11/16	1/2	
KC-30-9	KS-30-9	1/2	9	7/8	11/16	11/16	1/2	
-	KS-30-12	1/2	12	7/8	11/16	11/16	1/2	
KC-104-3	-	1/2	3	1	3/4	3/4	9/16	
KC-104-6	KS-104-6	1/2	6	1	3/4	3/4	9/16	
KC-104-9	KS-104-9	1/2	9	1	3/4	3/4	9/16	
KC-104-12	-	1/2	12	1	3/4	3/4	9/16	

Universal wrenches must not be used with impact drivers. Maximum operating angle is 30°.

1/4" Male Hex Universal Wrenches, SAE



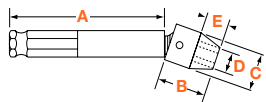

6 Point, Standard and Tension Type – Extension (continued)

	Part Number Standard	Part Number Tension	Hex Opening In.	Shank Length (A) In.	Socket Length (B) In.	Socket Diameter (C) In.	Nose End Diameter (D) In.	Clearance Depth (E) In.
 Standard Type	KC-105-3	-	9/16	3	1	13/16	13/16	9/16
	KC-105-4	-	9/16	4	1	13/16	13/16	9/16
 Tension Type	KC-105-6 	KS-105-6	9/16	6	1	13/16	13/16	9/16
	KC-105-9	KS-105-9	9/16	9	1	13/16	13/16	9/16
	KC-105-12	-	9/16	12	1	13/16	13/16	9/16



1/4" Male Hex Universal Wrenches, Metric

6 Point, Standard and Tension Type – Extension

	Part Number Standard	Part Number Tension	Hex Opening mm	Shank Length (A) mm	Socket Length (B) mm	Socket Diameter (C) mm	Nose End Diameter (D) mm	Clearance Depth (E) mm
 Standard Type	KC-5-7m-3	-	7	76	19.1	15.9	10.3	9.5
	KC-5-7m-4	-	7	102	19.1	15.9	10.3	9.5
 Tension Type	KC-5-7m-6	KS-5-7m-6	7	152	19.1	15.9	10.3	9.5
	KC-5-7m-9	KS-5-7m-9	7	229	19.1	15.9	10.3	9.5
	-	KS-5-7m-12	7	305	19.1	15.9	10.3	9.5
	KC-6-8m-3	-	8	76	19.1	19.1	11.1	7.9
	KC-6-8m-4	-	8	102	19.1	19.1	11.1	7.9
	KC-6-8m-6	KS-6-8m-6	8	152	19.1	19.1	11.1	7.9
	KC-6-8m-9	KS-6-8m-9	8	229	19.1	19.1	11.1	7.9
	KC-6-9m-3	-	9	76	19.1	19.1	12.7	7.9
	KC-6-9m-6	-	9	152	19.1	19.1	12.7	7.9
	KC-6-10m-3	-	10	76	20.6	19.1	15.1	9.5
	KC-6-10m-4	-	10	102	20.6	19.1	15.1	9.5
	KC-6-10m-6	KS-6-10m-6	10	152	20.6	19.1	15.1	9.5
KC-6-10m-9	KS-6-10m-9	10	229	20.6	19.1	15.1	9.5	
KC-6-10m-12	-	10	305	20.6	19.1	15.1	9.5	
KC-7-11m-3	-	11	76	23.8	22.2	15.9	10.3	
KC-7-11m-6	KS-7-11m-6	11	152	23.8	22.2	15.9	10.3	
KC-7-11m-9	KS-7-11m-9	11	229	23.8	22.2	15.9	10.3	
KC-7-12m-3	-	12	76	23.8	22.2	17.5	10.3	
KC-7-12m-6	-	12	152	23.8	22.2	17.5	10.3	
KC-7-12m-9	-	12	229	23.8	22.2	17.5	10.3	
KC-7-13m-3	-	13	76	25.4	22.2	17.5	11.9	
KC-7-13m-6	KS-7-13m-6	13	152	25.4	22.2	17.5	11.9	
KC-7-13m-9	KS-7-13m-9	13	229	25.4	22.2	17.5	11.9	
-	KS-7-13m-12	13	305	25.4	22.2	17.5	11.9	

Universal wrenches must not be used with impact drivers. Maximum operating angle is 30°.

7/16" Hex Drive Universal Wrenches, SAE



6 Point, Standard and Tension Type – Extension

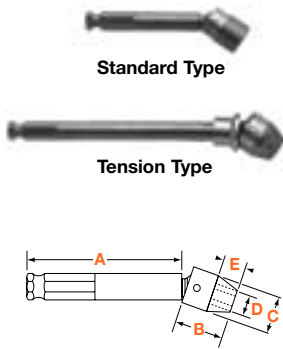



Universal wrenches must not be used with impact drivers. Maximum operating angle is 30°.

Part Number Standard	Part Number Tension	Hex Opening In.	Shank Length (A) In.	Socket Length (B) In.	Socket Diameter (C) In.	Nose End Diameter (D) In.	Clearance Depth (E) In.
KB-40-3	-	1/4	3	3/4	5/8	3/8	3/8
KB-40-4	-	1/4	4	3/4	5/8	3/8	3/8
KB-40-6	KT-40-6	1/4	6	3/4	5/8	3/8	3/8
KB-40-9	KT-40-9	1/4	9	3/4	5/8	3/8	3/8
KB-43-3	-	3/8	3	13/16	5/8	7/32	7/16
KB-43-4	-	3/8	4	13/16	5/8	7/32	7/16
KB-43-6	KT-43-6	3/8	6	13/16	5/8	7/32	7/16
-	KT-43-9	3/8	9	13/16	5/8	7/32	7/16
KB-44-3	-	7/16	3	7/8	5/8	5/8	1/2
KB-44-4	-	7/16	4	7/8	5/8	5/8	1/2
KB-44-6	KT-44-6	7/16	6	7/8	5/8	5/8	1/2
KB-44-9	KT-44-9	7/16	9	7/8	5/8	5/8	1/2
KB-44-12	KT-44-12	7/16	12	7/8	5/8	5/8	1/2
KB-45-3	-	1/2	3	7/8	11/16	11/16	1/2
KB-45-4	-	1/2	4	7/8	11/16	11/16	1/2
KB-45-6	KT-45-6	1/2	6	7/8	11/16	11/16	1/2
KB-45-9	KT-45-9	1/2	9	7/8	11/16	11/16	1/2
KB-45-12	KT-45-12	1/2	12	7/8	11/16	11/16	1/2
KB-104-6	KT-104-6	1/2	6	1	3/4	3/4	9/16
KB-104-9	KT-104-9	1/2	9	1	3/4	3/4	9/16
KB-202-4	-	1/2	4	1	7/8	11/16	15/32
KB-202-6	KT-202-6	1/2	6	1	7/8	11/16	15/32
-	KT-202-9	1/2	9	1	7/8	11/16	15/32
KB-202-12	KT-202-12	1/2	12	1	7/8	11/16	15/32
KB-317-3	-	1/2	3	1	1	11/16	7/16
KB-317-6	KT-317-6	1/2	6	1	1	11/16	7/16
KB-317-9	KT-317-9	1/2	9	1	1	11/16	7/16
KB-105-3	-	9/16	3	1	13/16	13/16	9/16
KB-105-4	-	9/16	4	1	13/16	13/16	9/16
KB-105-6	KT-105-6	9/16	6	1	13/16	13/16	9/16
-	KT-105-9	9/16	9	1	13/16	13/16	9/16
KB-105-12	KT-105-12	9/16	12	1	13/16	13/16	9/16
KB-203-3	-	9/16	3	1 1/16	7/8	3/4	17/32
KB-203-6	KT-203-6 	9/16	6	1 1/16	7/8	3/4	17/32
KB-203-9	KT-203-9	9/16	9	1 1/16	7/8	3/4	17/32
KB-203-12	KT-203-12	9/16	12	1 1/16	7/8	3/4	17/32
KB-318-3	KT-318-3	9/16	3	1 1/8	1	3/4	9/16

7/16" Hex Drive Universal Wrenches, SAE

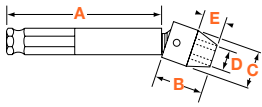

6 Point, Standard and Tension Type – Extension (continued)

	Part Number Standard	Part Number Tension	Hex Opening In.	Shank Length (A) In.	Socket Length (B) In.	Socket Diameter (C) In.	Nose End Diameter (D) In.	Clearance Depth (E) In.
 Standard Type	KB-318-6	KT-318-6 	9/16	6	1 1/8	1	3/4	9/16
	KB-318-9	KT-318-9	9/16	9	1 1/8	1	3/4	9/16
	KB-318-12	KT-318-12	9/16	12	1 1/8	1	3/4	9/16
 Tension Type	KB-205-3	-	5/8	3	1 1/8	7/8	7/8	19/32
	KB-205-4	-	5/8	4	1 1/8	7/8	7/8	19/32
	KB-205-6	KT-205-6	5/8	6	1 1/8	7/8	7/8	19/32
	KB-205-9	-	5/8	9	1 1/8	7/8	7/8	19/32
	KB-205-12	KT-205-12	5/8	12	1 1/8	7/8	7/8	19/32
	KB-320-3	-	5/8	3	1 3/16	1	27/32	5/8
	KB-320-4	-	5/8	4	1 3/16	1	27/32	5/8
	KB-320-6	KT-320-6	5/8	6	1 3/16	1	27/32	5/8
	KB-320-9	KT-320-9	5/8	9	1 3/16	1	27/32	5/8
	KB-320-12	KT-320-12	5/8	12	1 3/16	1	27/32	5/8
	KB-321-3	-	11/16	3	1 1/4	1	1	11/16
	KB-321-6	KT-321-6	11/16	6	1 1/4	1	1	11/16
KB-321-9	KT-321-9	11/16	9	1 1/4	1	1	11/16	
KB-321-12	KT-321-12	11/16	12	1 1/4	1	1	11/16	
KB-322-3	-	3/4	3	1 1/4	1 1/8	1 1/8	11/16	
KB-322-4	-	3/4	4	1 1/4	1 1/8	1 1/8	11/16	
KB-322-6	KT-322-6	3/4	6	1 1/4	1 1/8	1 1/8	11/16	
KB-322-9	KT-322-9	3/4	9	1 1/4	1 1/8	1 1/8	11/16	
KB-322-12	KT-322-12	3/4	12	1 1/4	1 1/8	1 1/8	11/16	



7/16" Hex Drive Universal Wrenches, Metric

6 Point, Standard and Tension Type – Extension

	Part Number Standard	Part Number Tension	Hex Opening mm	Shank Length (A) mm	Socket Length (B) mm	Socket Diameter (C) mm	Nose End Diameter (D) mm	Clearance Depth (E) mm
 Standard Type	KB-6-10m-3	-	10	76	20.6	19.1	15.1	9.5
	KB-6-10m-6	KT-6-10m-6	10	152	20.6	19.1	15.1	9.5
	KB-6-10m-9	KT-6-10m-9	10	229	20.6	19.1	15.1	9.5
 Tension Type	-	KT-6-10m-12	10	305	20.6	19.1	15.1	9.5
	KB-7-11m-3	-	11	76	23.8	22.2	15.9	10.3
	KB-7-11m-4	-	11	102	23.8	22.2	15.9	10.3
	KB-7-11m-6	KT-7-11m-6	11	152	23.8	22.2	15.9	10.3
	KB-7-11m-12	-	11	305	23.8	22.2	15.9	10.3

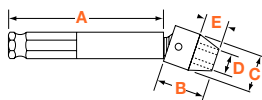

Universal wrenches must not be used with impact drivers. Maximum operating angle is 30°.

7/16" Hex Drive Universal Wrenches, Metric



6 Point, Standard and Tension Type – Extension (continued)

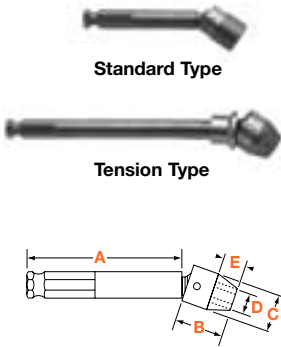

Universal wrenches must not be used with impact drivers. Maximum operating angle is 30°.

Part Number Standard	Part Number Tension	Hex Opening mm	Shank Length (A) mm	Socket Length (B) mm	Socket Diameter (C) mm	Nose End Diameter (D) mm	Clearance Depth (E) mm
KB-7-12m-6	-	12	152	23.8	22.2	17.5	10.3
KB-7-12m-9	-	12	229	23.8	22.2	17.5	10.3
KB-7-13m-3	-	13	76	25.4	22.2	17.5	11.9
KB-7-13m-4	-	13	102	25.4	22.2	17.5	11.9
KB-7-13m-6	KT-7-13m-6	13	152	25.4	22.2	17.5	11.9
KB-7-13m-9	KT-7-13m-9	13	229	25.4	22.2	17.5	11.9
KB-7-13m-12	-	13	305	25.4	22.2	17.5	11.9
KB-7-14m-3	-	14	76	27.0	22.2	19.1	13.5
KB-7-14m-4	-	14	102	27.0	22.2	19.1	13.5
KB-7-14m-6	KT-7-14m-6	14	152	27.0	22.2	19.1	13.5
KB-7-14m-9	KT-7-14m-9	14	229	27.0	22.2	19.1	14.3
-	KT-7-14m-12	14	305	27.0	22.2	19.1	14.3
-	KT-7-15m-6	15	152	27.0	22.2	19.1	14.3
-	KT-7-15m-8	15	204	27.0	22.2	19.1	14.3
KB-8-15m-6	KT-8-15m-6	15	152	28.6	25.4	19.8	14.3
KB-8-15m-9	KT-8-15m-9	15	229	28.6	25.4	19.8	14.3
KB-8-15m-12	KT-8-15m-12	15	305	28.6	25.4	19.8	14.3
KB-8-16m-3	-	16	76	30.2	25.4	21.4	15.9
KB-8-16m-6	KT-8-16m-6	16	152	30.2	25.4	21.4	15.9
KB-8-16m-9	KT-8-16m-9	16	229	30.2	25.4	21.4	15.9
KB-8-17m-12	KT-8-16m-12	16	305	30.2	25.4	21.4	15.9
KB-8-17m-3	-	17	76	31.8	25.4	25.4	17.5
KB-8-17m-6	KT-8-17m-6	17	152	31.8	25.4	25.4	17.5
KB-8-17m-9	KT-8-13m-9	17	229	31.8	25.4	25.4	17.5
KB-8-17m-12	KT-8-13m-12	17	305	31.8	25.4	25.4	17.5
KB-8-18m-3	-	18	76	31.8	25.4	25.4	17.5
KB-8-18m-6	KT-8-18m-6	18	152	31.8	25.4	25.4	17.5
KB-8-18m-9	KT-8-18m-9	18	229	31.8	25.	25.4	17.5
KB-8-18m-12	KT-8-18m-12	18	305	31.8	25.4	25.4	17.5
KB-10-19m-3	-	19	76	34.9	31.8	26.2	16.3
KB-10-19m-6	KT-10-19m-6	19	152	34.9	31.8	26.2	16.3
KB-10-19m-9	-	19	229	34.9	31.8	26.2	16.3
-	KT-10-19m-12	19	305	34.9	31.8	26.2	16.3

APEX® Solutions



When can I use a universal adapter?

A universal adapter gives all of your sockets the versatility of a universal wrench. Universal adapters must not be used with impact drivers.

(See page 83.)



Does Apex offer bolt clearance nutsetters?

Bolt clearance nutsetters allow the bolt or stud to recess into the nutsetter body as the nut is driven down. Bolt clearance nutsetters are prefixed with the numbers 6B-.

(See page 62.)

Does Apex offer Torx® sockets?

Like Torx® screws, Torx® bolts are becoming commonplace in a variety of assembly applications.



Apex offers a wide variety of Torx® sockets.

(See page 82.)

What is the advantage of surface drive sockets?

Use surface drive sockets if tools are still running when they engage the fasteners (such as on this multi-spindle machine). They're easier to engage and will result in less tool wear.



Does Apex universal wrenches with longer sockets?

Universal wrenches are available with a longer socket to allow a stud to recess into the socket opening.

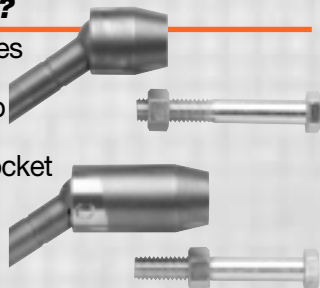

(Check with your Apex representative for details.)

What is the benefit of a tension sleeve?

A universal wrench with a tension sleeve holds the socket at the desired driving angle while aligning the tool and fastener. Other universal wrench sockets can “flop” making engagement difficult.

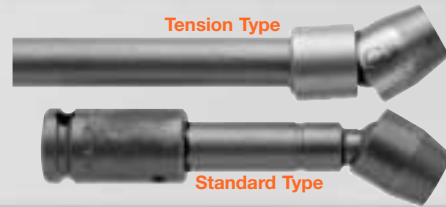

What types of magnetic sockets does Apex offer?

In addition to a fixed magnet socket (center), Apex offers spring-loaded (left) and cylindrical (right) magnet styles that allow the bolt to recess into the socket body as the nut is driven down. Fixed magnet sockets are designated by a M- part number prefix, spring-loaded by MB- prefix and cylindrical by a SM- prefix.



Does Apex offer thin wall sockets?

Thin wall sockets accommodate countersunk or limited clearance nut or bolt locations. Many of these sockets have a shouldered body design that can fit in tight quarters.



Does Apex offer a complete line of extensions?

Apex features a wide selection of extension lengths, styles and sizes.

(See the Table of Contents for a complete listing.)

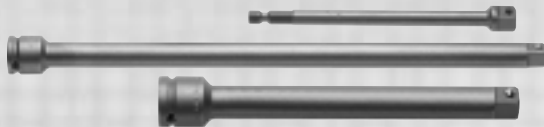

Can I use my extensions, adapters and universals with impact drivers?

Quality design and construction give Apex universal wrenches a long service life and durability. Remember, universal wrenches, extensions and adapters are not to be used with impact drivers.



Does Apex offer mar resistant bits and sockets?

Apex can nylon coat just about any of our bits or sockets. Nylon offers excellent mar resistance for assemblies that have painted, varnished or chromed surfaces. Nylon also offers some safety benefits by covering tool junctions. Contact your Apex distributor or representative for more information or for a quote.





Impact Sockets



Apex industrial grade impact sockets are available in a wide range of lengths and wall thicknesses, and with single or double hex openings. Square openings are available in select sizes.



Fixed Magnetic Sockets



Magnetic sockets hold the fastener in driving position, even when working straight down. Time-wasting motions are eliminated when starting fasteners or working in hard-to-reach areas. These sockets are identified with a M- prefix.



Magnetic Bolt Clearance Sockets



As the nut is run down, a spring-loaded or hollow cylinder magnet allows the bolt or stud to retract into the socket body. Nuts are held firmly in the socket. These sockets are identified with a MB- prefix.



Surface Drive Sockets



Large openings on the six corners of the opening create a “floating” action that allows the socket to slip quickly and easily onto the nut or bolt. Ideal for compensating for imperfect alignment between the tool and fastener. Not generally recommended for impact use. These sockets are identified with a SF- prefix.



Fast Lead Sockets



Designed for power tool and multiple spindle power tools, a specially tapered opening provides complete engagement with the nut almost instantly upon engagement. This speeds productivity and extends tool life. Engagement is possible without starting and stopping the tool for each nut. These sockets are identified with a FL- prefix.



Special Sockets

You'll find Spline, Torx®, tap holding, Budd Wheel, grease fitting and other sockets for special applications.



Extensions and Adapters

Apex provides the accessories needed to adapt sockets to nearly every tool and application.



Square Drive Universal Wrenches

Hard-to-reach areas are no problem with Apex's wide range of universal and extension universal wrenches.

1/4" Square Drive Sockets, SAE



Standard Length, 6 Point and Double Hex

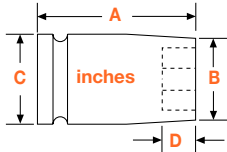

Part Number 6 Point	Part Number Double Hex	Hex Opening In.	Overall Length (A)	Diameter Nose End (B)	Diameter Drive End (C)	Opening Depth (D)
1105	-	5/32	7/8	1/4	1/2	3/32
1106	1106-D	3/16	7/8	5/16	1/2	3/32
1107	1107-D	7/32	7/8	3/8	1/2	5/32
1108	1108-D	1/4	7/8	3/8	1/2	5/32
X-1108*	-	1/4	7/8	3/8	1/2	5/32
1109	1109-D	9/32	1	7/16	1/2	3/16
1110	1110-D	5/16	1	1/2	1/2	3/16
X-1110*	-	5/16	1	1/2	1/2	3/16
HA-510	-	5/16	7/8	7/16	7/16	3/16
1111	1111-D	11/32	1	1/2	1/2	3/16
1112	1112-D	3/8	1	9/16	9/16	1/4
1113	1113-D	13/32	1	5/8	5/8	1/4
1114	1114-D	7/16	1	5/8	5/8	9/32
1115	-	15/32	1	11/16	11/16	9/32
1116	1116-D	1/2	1	11/16	11/16	11/32
1117	1117-D	17/32	1	3/4	3/4	11/32
1118	1118-D	9/16	1	13/16	13/16	7/16
1119	1119-D	19/32	1	7/8	7/8	7/16
1120	1120-D	5/8	1	7/8	7/8	7/16

* Parts have a harder heat treat.

Long Length, 6 Point and Double Hex

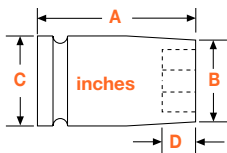

Part Number 6 Point	Part Number Double Hex	Hex Opening In.	Overall Length (A)	Diameter Nose End (B)	Diameter Drive End (C)	Opening Depth (D)
1206	1206-D	3/16	1 3/4	5/16	1/2	3/32
1207	1207-D	7/32	1 3/4	3/8	1/2	5/32
1208	1208-D	1/4	1 3/4	3/8	1/2	5/32
1209	1209-D	9/32	1 3/4	7/16	1/2	3/16
1210	1210-D	5/16	1 3/4	1/2	1/2	3/16
1211	1211-D	11/32	1 3/4	1/2	1/2	3/16
1212	1212-D	3/8	1 3/4	9/16	9/16	1/4
1213	-	13/32	1 3/4	5/8	5/8	1/4
1214	1214-D	7/16	1 3/4	5/8	5/8	9/32
1215	-	15/32	1 3/4	11/16	11/16	9/32
1216	1216-D	1/2	1 3/4	11/16	11/16	11/32
1217	-	17/32	1 3/4	3/4	3/4	11/32
1218	1218-D	9/16	1 3/4	13/16	13/16	7/16
1220	-	5/8	2	7/8	7/8	7/16

Refer to Page iv for description of Rapid Select.

1/4" Square Drive Sockets, SAE



Extra Long Length, 6 Point and Double Hex

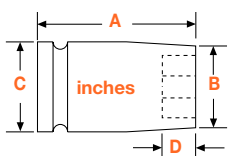

Part Number 6 Point	Part Number Double Hex	Hex Opening In.	Overall Length (A)	Diameter Nose End (B)	Diameter Drive End (C)	Opening Depth (D)
1308	1308-D	1/4	3	3/8	1/2	5/32
1310	1310-D	5/16	3	1/2	1/2	3/16
1311	1311-D	11/32	3	1/2	1/2	3/16
1312	1312-D	3/8	3	9/16	9/16	1/4
1313	1313-D	13/32	3	9/16	9/16	1/4
1314	1314-D	7/16	3	5/8	5/8	9/32
1316	1316-D	1/2	3	11/16	11/16	11/32
1318	-	9/16	3	13/16	13/16	7/16
1320	1320-D	5/8	3	7/8	7/8	7/16

Magnetic, Standard Length, 6 Point

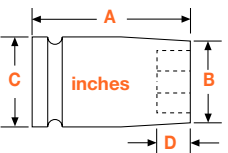

Part Number Fixed Magnet	Hex Opening In.	Overall Length (A)	Diameter Nose End (B)	Diameter Drive End (C)	Opening Depth (D)
M-1105	5/32	7/8	5/16	1/2	3/32
M-1106	3/16	7/8	5/16	1/2	3/32
M-1107	7/32	7/8	3/8	1/2	5/32
MX-1108*	1/4	7/8	3/8	1/2	5/32
M-1108-E*	1/4	7/8	3/8	1/2	5/32
MX-1109*	9/32	1	7/16	1/2	3/16
MHA-510	5/16	7/8	7/16	7/16	1/8
M-1110	5/16	1	1/2	1/2	3/16
MX-1110*	5/16	1	1/2	1/2	3/16
MX-1111	11/32	1	1/2	1/2	3/16
MHA-510	5/16	7/8	7/16	7/16	3/16
M-1112	3/8	1	9/16	9/16	1/4
MX-1112*	3/8	1	9/16	9/16	1/4
M-1114	7/16	1	5/8	5/8	9/32
M-1116	1/2	1	11/16	11/16	11/32
M-1118	9/16	1	11/16	11/16	11/32
M-1120	5/8	1	11/16	11/16	11/32

*Parts have a harder heat treat; MX-1108-E has no lead-in chamfer.

1/4" Square Drive Sockets, SAE

Magnetic, Long and Extra Long Length, 6 Point



Part No. Fixed Magnet	Part No. Magnetic Bolt Clearance	Hex Opening In.	Overall Length (A)	Diameter Nose End (B)	Diameter Drive End (C)	Opening Depth (D)
-	MB-1206	3/16	1 3/4	5/16	1/2	5/32
M-1208	MB-1208	1/4	1 3/4	3/8	1/2	5/32
-	MB-1308	1/4	3	3/8	1/2	5/32
M-1209	MB-1209	9/32	1 3/4	7/16	1/2	3/16
M-1210	MB-1210	5/16	1 3/4	1/2	1/2	3/16

(Continued on next page.)

Refer to Page iv for description of Rapid Select.

1/4" Square Drive Sockets, SAE

Magnetic, Long Length and Extra Long, 6 Point

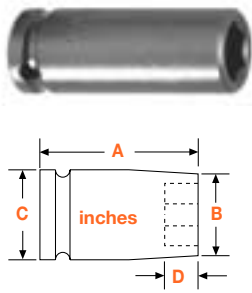

Part No. Fixed Magnet	Part No. Magnetic Bolt Clearance	Hex Opening In.	Overall Length (A)	Diameter Nose End (B)	Diameter Drive End (C)	Opening Depth (D)
M-1211	MB-1211	11/32	1 3/4	1/2	1/2	3/16
-	MB-1311	11/32	3	1/2	1/2	3/16
M-1212	MB-1212	3/8	1 3/4	9/16	9/16	1/4
-	MB-1312	3/8	3	9/16	9/16	1/4
M-1214	MB-1214	7/16	1 3/4	5/8	5/8	9/32
-	MB-1314	7/16	3	5/8	5/8	9/32
M-1216	MB-1216	1/2	1 3/4	11/16	11/16	11/32
-	MB-1218	9/16	1 3/4	13/16	13/16	7/16

* For explanation of magnets, see Tool Tip on page 120.

Surface Drive and Fast Lead, Standard and Long Length

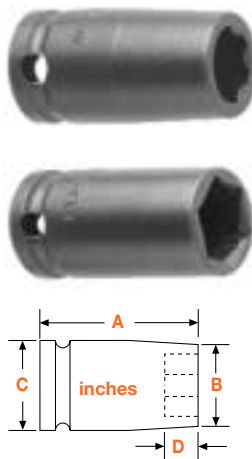

Part No. Surface Drive	Part No. Number Fast Lead	Hex Opening In.	Overall Length (A)	Diameter Nose End (B)	Diameter Drive End (C)	Opening Depth (D)
-	FL-1108	1/4	7/8	3/8	1/2	5/32
-	FL-1109	9/32	7/8	3/8	1/2	5/32
-	FL-1110	5/16	1	1/2	1/2	3/16
-	FL-1111	11/32	1	1/2	1/2	3/16
SF-1112	FL-1112	3/8	1	9/16	9/16	1/4
SF-1212	FL-1212	3/8	1 3/4	9/16	9/16	1/4
SF-1114	FL-1114	7/16	1	5/8	5/8	9/32
-	FL-1214	7/16	1 3/4	5/8	5/8	9/32
SF-1116	FL-1116	1/2	1	11/16	11/16	11/32
-	FL-1216	1/2	1 3/4	11/16	11/16	11/32
SF-1118	FL-1118	9/16	1	13/16	13/16	7/16

1/4" Square Drive Sockets For SAE Sheet Metal Screws

6 Point and 6 Point Magnetic, For Predrilled Holes*

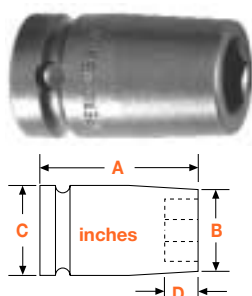

Part Number 6 Point	Part Number Magnetic	Hex Opening In.	Overall Length (A)	Diameter Nose End (B)	Diameter Drive End (C)	Opening Depth (D)
1E06	M1E06	3/16	7/8	5/16	1/2	3/32
1E07	M1E07	7/32	7/8	3/8	1/2	5/32
1E08	M1E08	1/4	7/8	3/8	1/2	5/32
1E09	M1E09	9/32	7/8	7/16	1/2	3/16
1E10	M1E10	5/16	7/8	1/2	1/2	3/16
1E11	M1E11	11/32	1	1/2	1/2	3/16
1E12	M1E12	3/8	1	5/8	5/8	1/4
1E14	M1E14	7/16	1	11/16	11/16	9/32
1E16	M1E16	1/2	1	11/16	11/16	11/32

*Sockets for predrilled holes are intermediate hardness; sockets for self-drilling and tapping screws are maximum hardness.

1/4" Square Drive Sockets For SAE Sheet Metal Screws



6 Point and 6 Point Magnetic, for Self-Drilling and Tapping Screws*

Part Number 6 Point	Part Number Magnetic	Hex Opening In.	Overall Length (A)	Diameter Nose End (B)	Diameter Drive End (C)	Opening Depth (D)
1P06	M1P06	3/16	7/8	5/16	1/2	3/32
1P07	M1P07	7/32	7/8	3/8	1/2	5/32
1P08	M1P08	1/4	7/8	7/16	1/2	5/32
	M1P09	9/32	7/8	1/2	1/2	3/16
1P10	M1P10	5/16	7/8	1/2	1/2	3/16
1P11	M1P11	11/32	1	1/2	1/2	3/16
1P12	M1P12	3/8	1	5/8	5/8	1/4
1P14	M1P14	7/16	1	11/16	11/16	9/32
1P16	M1P16	1/2	1	11/16	11/16	11/32

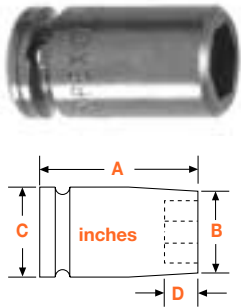

*Sockets for predrilled holes are intermediate hardness; sockets for self-drilling and tapping screws are maximum hardness.

1/4" Square Drive Sockets For SAE Square Nuts

Single Square and Double Square

Part Number Square	Part No. Double Square	Hex Opening In.	Overall Length (A)	Diameter Nose End (B)	Diameter Drive End (C)	Opening Depth (D)
1608	1608-D	1/4	1	1/2	1/2	3/16
1609	1609-D	9/32	1	9/16	9/16	3/16
1610	1610-D	5/16	1	5/8	5/8	1/4
1611	-	11/32	1	3/4	3/4	1/4
1612	1612-D	3/8	1	3/4	3/4	1/4
1614	1614-D	7/16	1	13/16	13/16	9/32

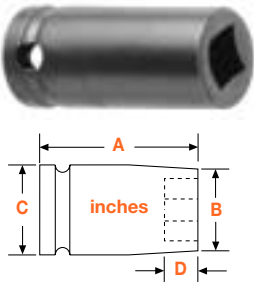

1/4" Square Drive Universal Wrenches, SAE

6 Point and Double Hex

Part Number 6 Point	Part Number Double Hex	Hex Opening In.	Overall Length (A)	Socket Length (B)	Socket Diameter (C)	Nose End Diameter (D)	Clearance Depth (E)
SA-25	SA-25-D	1/4	1 7/32	3/4	5/8	3/8	3/8
SA-26	SA-26-D	5/16	1 17/32	3/4	5/8	7/16	3/8
SA-28	SA-28-D	3/8	1 19/32	13/16	5/8	17/32	7/16
SA-29	SA-29-D	7/16	1 21/32	7/8	5/8	5/8	1/2
SA-30	SA-30-D	1/2	1 21/32	7/8	11/16	11/16	1/2
SA-65	-	9/16	1 21/32	7/8	11/16	11/16	1/2

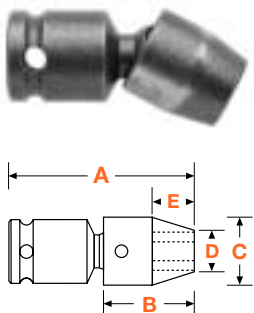

Universal wrenches must not be used with impact drivers. Maximum operating angle is 30°.

1/4" Square Drive Sockets, Metric

Standard Length, 6 Point and Double Hex

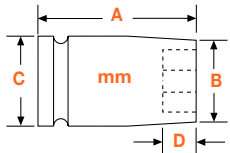

Part Number 6 Point	Part Number Double Hex	Hex Opening mm	Overall Length (A)	Diameter Nose End (B)	Diameter Drive End (C)	Opening Depth (D)
3.5mm11	-	3.5	22.2	6.4	12.7	2.4
4mm11	-	4	22.2	6.4	12.7	2.4
4.5mm11	-	4.5	22.2	7.9	12.7	2.4
5mm11	-	5	22.2	8.7	12.7	3.9
5.5mm11	-	5.5	22.2	9.5	12.7	3.9
6mm11	6mm11-D	6	22.2	9.5	12.7	3.9
7mm11	7mm11-D	7	22.2	11.1	12.7	4.8
8mm11	8mm11-D	8	25.4	12.7	12.7	4.8
9mm11	9mm11-D	9	25.4	14.3	14.3	4.8
10mm11	10mm11-D	10	25.4	15.9	15.9	6.4
OS-10mm11	-	10	25.4	14.3	14.3	6.4
11mm11	11mm11-D	11	25.4	15.9	15.9	7.2
12mm11	12mm11-D	12	25.4	17.5	17.5	7.2
13mm11	13mm11-D	13	25.4	19.1	19.1	8.7
14mm11	14mm11-D	14	25.4	20.6	20.6	11.1
15mm11	15mm11-D	15	25.4	22.2	22.2	11.1
16mm11	-	16	25.4	22.2	22.2	11.1

Long Length, 6 Point and Double Hex

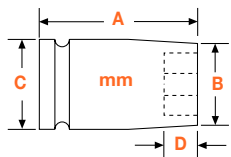

Part Number 6 Point	Part Number Double Hex	Hex Opening mm	Overall Length (A)	Diameter Nose End (B)	Diameter Drive End (C)	Opening Depth (D)
5mm21	-	5	44.4	8.7	12.7	3.9
5.5mm21	-	5.5	44.4	9.5	12.7	3.9
6mm21	-	6	44.4	9.5	12.7	3.9
7mm21	7mm21-D	7	44.4	11.1	12.7	4.8
8mm21	8mm21-D	8	44.4	12.7	12.7	4.8
9mm21	9mm21-D	9	44.4	14.3	14.3	4.8
10mm21	10mm21-D	10	44.4	15.9	15.9	6.4
11mm21	11mm21-D	11	44.4	15.9	15.9	7.2
12mm21	12mm21-D	12	44.4	17.5	17.5	7.2
13mm21	13mm21-D	13	44.4	19.1	19.1	8.7
14mm21	-	14	44.4	20.6	20.6	11.1
15mm21	15mm21-D	15	50.8	22.2	22.2	11.1
16mm21	-	16	50.8	22.2	22.2	11.1

1/4" Square Drive Sockets, Metric



Magnetic, Standard Length, 6 Point

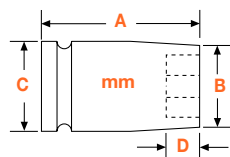

Part Number Fixed Magnet	Hex Opening mm	Overall Length (A)	Diameter Nose End (B)	Diameter Drive End (C)	Opening Depth (D)
M-5mm11	5	22.2	8.7	12.7	3.9
M-5.5mm11	5.5	22.2	9.5	12.7	3.9
M-6mm11	6	22.2	9.5	12.7	3.9
M-7mm11	7	22.2	11.9	12.7	4.8
M-8mm11	8	25.4	12.7	12.7	4.8
M-9mm11	9	25.4	14.3	14.3	4.8
M-10mm11	10	25.4	15.9	15.9	6.4
M-11mm11	11	25.4	15.9	15.9	7.2
M-12mm11	12	25.4	17.5	17.5	7.2
M-13mm11	13	25.4	19.1	19.1	8.7
M-14mm11	14	25.4	20.6	20.6	11.1
M-15mm11	15	25.4	22.2	22.2	11.1

Magnetic, Long Length, 6 Point

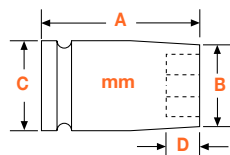

Part No. Fixed Magnet	Part No. Magnetic Bolt Clearance	Hex Opening mm	Overall Length (A)	Diameter Nose End (B)	Diameter Drive End (C)	Opening Depth (D)
M-5mm21	MB-5mm21	5	44.4	8.7	12.7	3.9
-	MB-5.5mm21	5.5	44.4	9.5	12.7	3.9
M-6mm21	MB-6mm21	6	44.4	9.5	12.7	3.9
M-7mm21	MB-7mm21	7	44.4	11.9	12.7	4.8
M-8mm21	MB-8mm21	8	44.4	12.7	12.7	4.8
M-9mm21	MB-9mm21	9	44.4	14.3	14.3	4.8
M-10mm21	MB-10mm21	10	44.4	15.9	15.9	6.4
-	**OSMB-10mm21	10	44.4	14.2	14.2	6.4
M-11mm21	MB-11mm21	11	44.4	15.9	15.9	7.2
M-12mm21	MB-12mm21	12	44.4	17.5	17.5	7.2
M-13mm21	MB-13mm21	13	44.4	19.1	19.1	8.7
M-14mm21	MB-14mm21	14	44.4	20.6	20.6	11.1
-	MB-15mm21	15	50.8	22.2	22.2	11.1
-	MB-16mm21	16	50.8	22.2	22.2	11.1

* For an explanation of magnets, see Tool Tip on page 112.

** No ring groove.

Surface Drive, Standard and Long Length

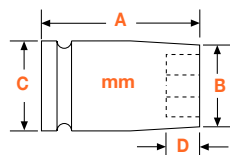

Part Number Surface Drive	Hex Opening mm	Overall Length (A)	Diameter Nose End (B)	Diameter Drive End (C)	Opening Depth (D)
SF-8mm11	8	25.4	12.7	12.7	4.7
SF-10mm11	10	25.4	15.9	15.9	6.4
SF-10mm21	10	44.4	15.9	15.9	6.4
SF-11mm11	11	25.4	15.9	15.9	7.2
SF-11mm21	11	44.4	15.9	15.9	7.2
SF-12mm21	11	44.4	17.5	15.9	7.2
SF-13mm11	13	25.4	19.1	19.1	8.7
SF-13mm21	13	44.4	19.1	19.1	8.7
SF-14mm11	14	25.4	20.6	20.6	11.1
SF-14mm21	14	44.4	20.6	20.6	11.1
SF-15mm11	15	25.4	22.2	22.2	11.1

Refer to Page iv for description of Rapid Select.

1/4" Square Drive Sockets For Metric Sheet Metal Screws

6 Point and 6 Point Magnetic

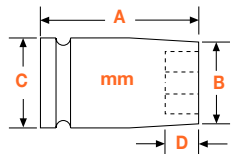

Part Number 6 Point	Part Number Magnetic	Hex Opening mm	Overall Length (A)	Diameter Nose End (B)	Diameter Drive End (C)	Opening Depth (D)
3.5mmE1	M-3.5mmE1	3.5	22.2	6.4	12.7	2.4
4mmE1	M-4mmE1	4	22.2	6.4	12.7	2.4
4.5mmE1	M-4.5mmE1	4.5	22.2	7.9	12.7	2.4
5mmE1	M-5mmE1	5	22.2	8.7	12.7	3.9
5.5mmE1	M-5.5mmE1	5.5	22.2	9.5	12.7	3.9
6mmE1	M-6mmE1	6	22.2	9.5	12.7	3.9
7mmE1	M-7mmE1	7	22.2	11.1	12.7	4.8
-	MR-7mmE1*	7	22.2	11.1	12.7	4.8
8mmE1	M-8mmE1	8	25.4	12.7	12.7	4.8
9mmE1	M-9mmE1	9	25.4	14.3	14.3	4.8
10mmE1	M-10mmE1	10	25.4	15.9	15.9	6.4
11mmE1	M-11mmE1	11	25.4	17.5	17.5	7.2
12mmE1	M-12mmE1	12	25.4	17.5	17.5	7.2
13mmE1	M-13mmE1	13	25.4	19.1	19.1	8.7

*MR-7mmE1 has stronger magnet

1/4" Square Drive Universal Wrenches, Metric 6 Point

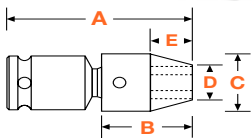

Part Number 6 Point	Hex Opening mm	Overall Length (A)	Socket Length (B)	Socket Diameter (C)	Nose End Diameter (D)	Opening Depth (E)
SA-15-6m	6	31	19.1	15.9	9.5	9.5
SA-15-7m	7	31	19.1	15.9	10.3	9.5
SA-16-8m	8	38	19.1	19.1	11.1	7.9
SA-16-10m	10	40	20.6	19.1	15.1	9.5

Universal wrenches must not be used with impact drivers. Maximum operating angle is 30°.

1/4" Square Drive Sockets For Spline Fasteners Standard and Long Length

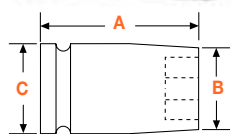

Apex spline sockets conform to military specifications MS-37787 and MIL-W-8982C.

Part Number	Spline Size	Nominal Size	Overall Length (A)		Diameter Nose End (B)		Diameter Drive End (C)	
			In.	mm	In.	mm	In.	mm
CMS-1407	7	7/32	7/8	22	21/64	8	7/16	11
CMS-1507	7	7/32	2	51	21/64	8	7/16	11
CMS-1408	8	1/4	7/8	22	3/8	10	7/16	11
CMS-1508	8	1/4	2	51	3/8	10	7/16	11
CMS-1409	9	9/32	7/8	22	7/16	11	7/16	11
CMS-1509	9	9/32	2	51	7/16	11	7/16	11
CMS-1410	10	5/16	7/8	22	29/64	12	29/64	12
CMS-1510	10	5/16	2	51	29/64	12	29/64	12
CMS-1412	12	3/8	7/8	22	17/32	14	17/32	14
CMS-1414	14	7/16	1	25	39/64	16	39/64	16

Refer to Page iv for description of Rapid Select.

1/4" Square Drive Torx® Sockets



For External Torx Screws

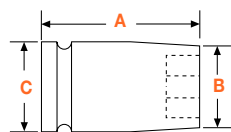

Part Number	Driver Size	Overall Length (A)		Nose End Diameter (B)		Drive End Diameter (C)	
		In.	mm	In.	mm	In.	mm
TX-1104	E-4	1	25.4	1/4	6.4	1/2	12.7
TX-1105	E-5	1	25.4	1/4	6.4	1/2	12.7
TX-1106	E-6	1	25.4	5/16	7.9	1/2	12.7
TX-1108	E-8	1	25.4	3/8	9.5	1/2	12.7
TX-1110	E-10	1	25.4	9/16	14.3	9/16	14.3
TX-1112	E-12	1	25.4	5/8	15.9	5/8	15.9

For External Torx Screws, Thin Wall

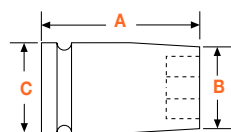

Part Number	Driver Size	Overall Length (A)		Nose End Diameter (B)		Drive End Diameter (C)	
		In.	mm	In.	mm	In.	mm
TX-1404	E-4	1	25.4	1/4	6.4	1/2	12.7
TX-1405	E-5	1	25.4	1/4	6.4	1/2	12.7
TX-1406	E-6	1	25.4	5/16	7.9	1/2	12.7
TX-1407	E-7	1	25.4	5/16	7.9	1/2	12.7
TX-1408	E-8	1	25.4	3/8	9.5	1/2	12.7
TX-1410	E-10	1	25.4	1/2	12.7	1/2	12.7
TX-1411	E-11	1	25.4	1/2	12.7	1/2	12.7
TX-1412	E-12	1	25.4	9/16	14.3	9/16	14.3

For Torx Nuts

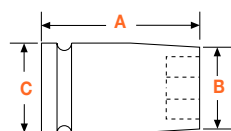

Part Number	Driver Size	Overall Length (A)		Nose End Diameter (B)		Drive End Diameter (C)	
		In.	mm	In.	mm	In.	mm
TX-1E04	E-4	7/8	22.2	5/16	7.9	1/2	12.7
TX-1E05	E-5	7/8	22.2	3/8	9.5	1/2	12.7
TX-1E06	E-6	7/8	22.2	7/16	11.1	1/2	12.7
TX-1E08	E-8	7/8	22.2	1/2	12.7	1/2	12.7
TX-1E10	E-10	1	25.4	9/16	14.3	9/16	14.3
TX-1E12	E-12	1	25.4	5/8	15.9	5/8	15.9

Sockets for Torx® nuts have a larger lead-in chamfer than sockets for external Torx® screws. Most Torx® sockets have a DIN (pin and o-ring) groove.

1/4" Square Drive Extensions

7/8" to 14" (22mm to 356mm) Length



Part Number	Male Square In.	Type of Lock	Overall Length	
			In.	mm
EX-252	1/4	Pin	7/8	22
EX-252-B	1/4	Ball	1	25
EX-255-2	1/4	Pin	2	51
EX-255-B-2	1/4	Ball	2	51
EX-255-3	1/4	Pin	3	76
EX-255-4	1/4	Pin	4	102
EX-255-B-4	1/4	Ball	4	102
EX-255-6	1/4	Pin	6	152
EX-255-B-6	1/4	Ball	6	152
EX-255-8	1/4	Pin	8	203
EX-255-10	1/4	Pin	10	254
EX-255-12	1/4	Pin	12	305
EX-255-14	1/4	Pin	14	356

1/4" Square Drive Adapters

1/4" to 3/8" Male Square



Part Number	Male Square In.	Female Square In.	Type of Lock	Overall Length	
				In.	mm
EX-372	3/8	1/4	Pin	1	0
EX-372-B	3/8	1/4	Ball	1	25

1/4" Square Drive Universal Adapters

Male Square to Female Square



Part Number	Male Sq. In.	Female Sq. In.	Type of Lock	Overall Length		Largest Diameter	
				In.	mm	In.	mm
MF-25	1/4	1/4	Pin	1 5/8	41	5/8	16
MF-25B	1/4	1/4	Ball	1 5/8	41	5/8	16

Universal wrenches must not be used with impact drivers. Maximum operating angle is 30°.

3/8" Square Drive Sockets, SAE



6 Point and Double Hex, Short and Standard Length

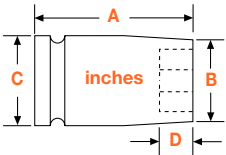

Part Number 6 Point	Part Number Double Hex	Hex Opening In.	Overall Length (A)	Diameter Nose End (B)	Diameter Drive End (C)	Opening Depth (D)
3108	3108-D	1/4	1 1/4	7/16	3/4	5/32
3109	3109-D	9/32	1 1/4	7/16	3/4	3/16
3010	-	5/16	7/8	1/2	3/4	3/16
3110	3110-D	5/16	1 1/4	1/2	3/4	3/16
3111	3111-D	11/32	1 1/4	1/2	3/4	3/16
3012	3012-D	3/8	7/8	19/32	3/4	3/16
3112	3112-D	3/8	1 1/4	19/32	3/4	1/4
3113	3113-D	13/32	1 1/2	11/16	3/4	1/4
3014	3014-D	7/16	7/8	11/16	3/4	9/32
3114	3114-D	7/16	1 1/2	11/16	3/4	9/32
SW-604	SW-604-D	7/16	1 1/2	21/32	3/4	9/32
3115	-	15/32	1 1/2	3/4	3/4	9/32
3016	3016-D	1/2	7/8	13/16	13/16	5/16
3116	3116-D	1/2	1 1/2	13/16	13/16	11/32
HC-3816	HC-3816-D	1/2	1 1/2	11/16	11/16	11/32
3117	3117-D	17/32	1 1/2	13/16	13/16	11/32
3018	3018-D	9/16	7/8	7/8	7/8	5/16
3118	3118-D	9/16	1 1/2	7/8	7/8	7/16
SW-343	SW-343-D	9/16	1 1/2	3/4	3/4	7/16
SW-605	SW-605-D	9/16	1 1/2	3/4	13/16	7/16
3119	-	19/32	1 1/2	7/8	7/8	7/16
3020	3020-D	5/8	1	15/16	15/16	7/16
3120	3120-D	5/8	1 1/2	15/16	15/16	7/16
HC-3520*	-	5/8	2 3/8	7/8	7/8	7/32
3121	3121-D	21/32	1 1/2	15/16	15/16	7/16
3022	3022-D	11/16	1	1	1	7/16
3122	3122-D	11/16	1 1/2	1	1	7/16
3024	3024-D	3/4	1	1 1/16	1 1/16	7/16
3124	3124-D	3/4	1 1/2	1 1/16	1 1/16	15/32
3026	3026-D	13/16	1	1 1/8	1 1/8	7/16
3126	-	13/16	1 1/2	1 1/8	1 1/8	7/16
3028	3028-D	7/8	1	1 1/4	1 1/4	7/16

*HC-3520 is spark plug socket.

3/8" Square Drive Sockets, SAE



6 Point and Double Hex, Thin Wall, Standard Length

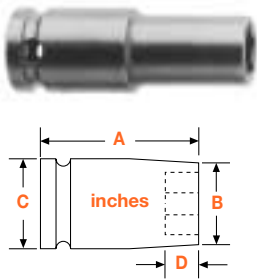

Part Number 6 Point	Part Number Double Hex	Hex Opening In.	Overall Length (A)	Diameter Nose End (B)	Diameter Drive End (C)	Opening Depth (D)
3408	3408-D	1/4	1 1/4	7/16	3/4	5/32
3409	-	9/32	1 1/4	7/16	3/4	3/16
3410	3410-D	5/16	1 1/4	1/2	3/4	3/16
OS-3410*	-	5/16	1 1/4	7/16	19/32	3/16
3411	-	11/32	1 1/4	1/2	3/4	3/16
3412	3412-D	3/8	1 1/2	19/32	3/4	1/4
3414	3414-D	7/16	1 1/2	5/8	3/4	9/32
3416	3416-D	1/2	1 1/2	3/4	3/4	11/32
3418	3418-D	9/16	1 1/2	25/32	13/16	7/16
3420	3420-D	5/8	1 1/2	7/8	7/8	7/16
3422	3422-D	11/16	1 1/2	15/16	15/16	7/16
3424	3424-D	3/4	1 1/2	1	1	15/32
3426	3426-D	13/16	1 1/2	1 1/8	1 1/8	17/32
3428	3428-D	7/8	1 1/2	1 3/16	1 1/4	9/16
3430	3430-D	15/16	1 1/2	1 5/16	1 5/16	5/8
3432	3432-D	1	1 1/2	1 3/8	1 3/8	5/8
3434	3434-D	1 1/16	1 1/2	1 1/2	1 1/2	11/16

*No ring groove.

6 Point and Double Hex, Long and Extra Long Length

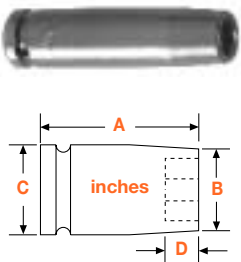

Part Number 6 Point	Part Number Double Hex	Hex Opening In.	Overall Length (A)	Diameter Nose End (B)	Diameter Drive End (C)	Opening Depth (D)
3208	3208-D	1/4	2	7/16	3/4	5/32
3308	3308-D	1/4	3 1/2	7/16	3/4	5/32
3209	3209-D	9/32	2	7/16	3/4	3/16
3210	3210-D	5/16	2	1/2	3/4	3/16
3310	3310-D	5/16	3 1/2	1/2	3/4	3/16
OS-3310-D*	-	5/16	3 1/2	15/32	5/8	3/16
3211	3211-D	11/32	2	1/2	3/4	3/16
3311	-	11/32	3 1/2	1/2	3/4	3/16
3212	3212-D	3/8	2	19/32	3/4	1/4
3312	3312-D	3/8	3 1/2	19/32	3/4	1/4
3214	3214-D	7/16	2	11/16	3/4	9/32
3314	3314-D	7/16	3 1/2	11/16	3/4	9/32
3216	3216-D	1/2	2	13/16	13/16	11/32
3316	3316-D	1/2	3 1/2	13/16	13/16	11/32
3218	3218-D	9/16	2	7/8	7/8	7/16
3318	3318-D	9/16	3 1/2	7/8	7/8	7/16
3220	3220-D	5/8	2	15/16	15/16	7/16
3320	3320-D	5/8	3 1/2	15/16	15/16	7/16
3222	3222-D	11/16	2	1	1	7/16
3322	3322-D	11/16	3 1/2	1	1	7/16
3224	3224-D	3/4	2	1 1/16	1 1/16	15/32
3324	3324-D	3/4	3 1/2	1 1/16	1 1/16	15/32
3226	3226-D	13/16	2	1 1/4	1 1/4	17/32
3326	3326-D	13/16	3 1/2	1 1/4	1 1/4	17/32
3228	3228-D	7/8	2	1 1/4	1 1/4	9/16
3328	3328-D	7/8	3 1/2	1 1/4	1 1/4	9/16

*No ring groove.

Refer to Page iv for description of Rapid Select.

3/8" Square Drive Sockets, SAE



6 Point and Double Hex, Thin Wall, Long Length

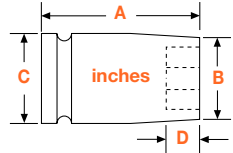

Part Number 6 Point	Part Number Double Hex	Hex Opening In.	Overall Length (A)	Diameter Nose End (B)	Diameter Drive End (C)	Opening Depth (D)
3510	-	5/16	2	1/2	3/4	3/16
3511	-	11/32	2	1/2	3/4	3/16
3512	3512-D	3/8	2	19/32	3/4	1/4
3513	-	3/8	2	5/8	3/4	1/4
3514	3514-D	7/16	2	5/8	3/4	9/32
3516	3516-D	1/2	2	3/4	3/4	11/32
3518	3518-D	9/16	2	25/32	13/16	7/16
3522	3522-D	11/16	2	15/16	15/16	7/16
3524	3524-D	3/4	2	1	1	15/32
3530	3530-D	15/16	2	1 5/16	1 5/16	5/8
3532	3532-D	1	2	1 3/8	1 3/8	5/8
3534	-	1 1/16	2	1 1/2	1 1/2	11/16

Magnetic, Short and Standard Length

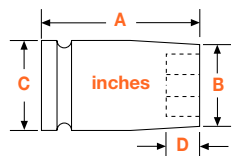

Part Number Fixed Magnet	Hex Opening In.	Overall Length (A)	Diameter Nose End (B)	Diameter Drive End (C)	Opening Depth (D)
M-3108	1/4	1 1/4	7/16	3/4	5/32
M-3109	9/32	1 1/4	7/16	3/4	3/16
M-3110	5/16	1 1/4	1/2	3/4	3/16
M-3111	11/32	1 1/4	1/2	3/4	3/16
M-3012	3/8	7/8	19/32	3/4	3/16
M-3112	3/8	1 1/4	19/32	3/4	1/4
M-3014	7/16	7/8	11/16	3/4	9/32
M-3114	7/16	1 1/2	11/16	3/4	9/32
MSW-604	7/16	1 1/2	21/32	3/4	9/32
M-3115	15/32	1 1/2	3/4	3/4	9/32
M-3016	1/2	7/8	13/16	13/16	5/16
M-3116	1/2	1 1/2	13/16	13/16	11/32
MHC-3816	1/2	1 1/2	11/16	11/16	11/32
M-3117	17/32	1 1/2	13/16	13/16	11/32
M-3018	9/16	7/8	7/8	7/8	5/16
M-3118	9/16	1 1/2	7/8	7/8	7/16
MSW-343	9/16	1 1/2	3/4	3/4	7/16
M-3119	19/32	1 1/2	7/8	7/8	7/16
M-3120	5/8	1 1/2	15/16	15/16	7/16
M-3122	11/16	1 1/2	1	1	7/16

3/8" Square Drive Sockets, SAE



Magnetic, Thin Wall, Standard Length

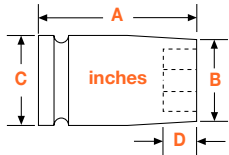

Part Number Fixed Magnet	Hex Opening In.	Overall Length (A)	Diameter Nose End (B)	Diameter Drive End (C)	Opening Depth (D)
M-3408	1/4	1 1/4	7/16	3/4	5/32
M-3409	9/32	1 1/4	7/16	3/4	3/16
M-3410	5/16	1 1/4	1/2	3/4	3/16
OSM-3410*	5/16	1 1/4	7/16	19/32	3/16
M-3411	11/32	1 1/4	1/2	3/4	3/16
M-3412	3/8	1 1/2	19/32	3/4	1/4
M-3414	7/16	1 1/2	5/8	3/4	9/32
OSM-3414*	7/16	1 1/2	5/8	5/8	9/32
M-3416	1/2	1 1/2	3/4	3/4	11/32
M-3418	9/16	1 1/2	25/32	13/16	7/16
M-3420	5/8	1 1/2	7/8	7/8	7/16
M-3424	3/4	1 1/2	1	1	15/32
M-3426	13/16	1 1/2	1 1/8	1 1/8	17/32
M-3430	15/16	1 1/2	1 5/16	1 5/16	17/32

*No ring groove.

Magnetic, Long Length and Extra Long Length

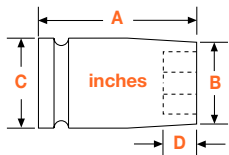

Part No. Fixed Magnet	Part No. Magnetic Bolt Clearance	Hex Opening In.	Overall Length (A)	Diameter Nose End (B)	Diameter Drive End (C)	Opening Depth (D)
-	MB-3210	5/16	2	1/2	3/4	3/16
M-3212	MB-3212	3/8	2	19/32	3/4	1/4
M-3214	MB-3214	7/16	2	11/16	3/4	9/32
-	MB-3314	7/16	3 1/2	11/16	3/4	9/32
M-3216	MB-3216	1/2	2	13/16	13/16	11/32
M-3218	MB-3218	9/16	2	7/8	7/8	7/16
-	MB-3318	9/16	3 1/2	7/8	7/8	7/16
-	MB-3220	5/8	2	15/16	15/16	7/16

Magnetic, Thin Wall, Long Length

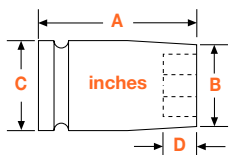

Part No. Fixed Magnet	Part No. Magnetic Bolt Clearance	Hex Opening In.	Overall Length (A)	Diameter Nose End (B)	Diameter Drive End (C)	Opening Depth (D)
-	MB-3512	3/8	2	19/32	3/4	1/4
M-3514	MB-3514	7/16	2	5/8	3/4	9/32
-	MB-3516	1/2	2	3/4	3/4	11/32

3/8" Square Drive Sockets, SAE



Surface Drive and Fast Lead, Short and Standard Length

	Part No. Surface Drive	Part Number Fast Lead	Hex Opening In.	Overall Length (A)	Diameter Nose End (B)	Diameter Drive End (C)	Opening Depth (D)
	SF-3108	FL-3108	1/4	1 1/4	7/16	3/4	5/32
	SF-3010	-	5/16	7/8	1/2	3/4	3/16
	SF-3110	FL-3110	5/16	1 1/4	1/2	3/4	3/16
	SF-3012	FL-3012	3/8	7/8	19/32	3/4	3/16
	SF-3112	FL-3112	3/8	1 1/4	19/32	3/4	1/4
	SF-3014	FL-3014	7/16	7/8	11/16	3/4	9/32
	SF-3114	FL-3114	7/16	1 1/2	11/16	3/4	9/32
	SF-3016	FL-3016	1/2	7/8	13/16	13/16	5/16
	SF-3116	FL-3116	1/2	1 1/2	13/16	13/16	11/32
	SF-HC3816	-	1/2	1 1/2	11/16	11/16	11/32
	SF-3018	FL-3018	9/16	7/8	7/8	7/8	5/16
	SF-3118	FL-3118	9/16	1 1/2	7/8	7/8	7/16
	-	FL-3119	19/32	1 1/2	7/8	7/8	7/16
-	FL-3020	5/8	1	15/16	15/16	7/16	
SF-3120	FL-3120	5/8	1 1/2	15/16	15/16	7/16	
-	FL-3022	11/16	1	15/16	15/16	7/16	
SF-3122	FL-3122	11/16	1 1/2	1	1	7/16	
-	FL-3024	3/4	1	1 1/16	1 1/16	7/16	
SF-3124	FL-3124	3/4	1 1/2	1 1/16	1 1/16	15/32	
SF-3028	-	7/8	1	1 1/4	1 1/4	9/16	

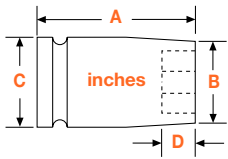

Surface Drive and Fast Lead, Thin Wall, Standard Length

	Part No. Surface Drive	Part Number Fast Lead	Hex Opening In.	Overall Length (A)	Diameter Nose End (B)	Diameter Drive End (C)	Opening Depth (D)
	-	FL-3410	5/16	1 1/4	1/2	3/4	3/16
	SF-3412	FL-3412	3/8	1 1/2	19/32	3/4	1/4
	SF-3414	FL-3414	7/16	1 1/2	5/8	3/4	9/32
	SF-3416	-	1/2	1 1/2	3/4	3/4	11/32
	SF-3418	-	9/16	1 1/2	25/32	13/16	7/16
	SF-3420	-	5/8	1 1/2	7/8	7/8	7/16
	SF-3422	-	11/16	1 1/2	15/16	15/16	7/16
	SF-3430	-	15/16	1 1/2	1 5/16	1 5/16	7/16
	SF-3432	-	1	1 1/2	1 3/8	1 3/8	5/8

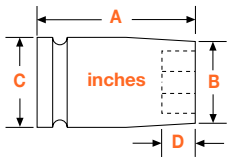

3/8" Square Drive Sockets, SAE



Surface Drive and Fast Lead, Long and Extra Long Length

Part No. Surface Drive	Part Number Fast Lead	Hex Opening In.	Overall Length (A)	Diameter Nose End (B)	Diameter Drive End (C)	Opening Depth (D)
-	FL-3210	5/16	2	1/2	3/4	3/16
SF-3212	FL-3212	3/8	2	19/32	3/4	1/4
SF-3312	FL-3312	3/8	3 1/2	19/32	3/4	1/4
SF-3214	FL-3214	7/16	2	11/16	3/4	9/32
SF-3314	FL-3314	7/16	3 1/2	11/16	3/4	9/32
SF-3216	FL-3216	1/2	2	13/16	13/16	11/32
SF-3316 	FL-3316	1/2	3 1/2	13/16	13/16	11/32
SF-3218	FL-3218	9/16	2	7/8	7/8	7/16
SF-3318	FL-3318	9/16	3 1/2	7/8	7/8	7/16
SF-3220	FL-3220	5/8	2	15/16	15/16	7/16
SF-3320	FL-3320	5/8	3 1/2	15/16	15/16	7/16
SF-3222	-	11/16	2	1	1	7/16
SF-3322	-	11/16	3 1/2	1	1	7/16
SF-3224	-	3/4	2	1 1/16	1 1/16	15/32
SF-3324	FL-3324	3/4	3 1/2	1 1/16	1 1/16	15/32
SF-3226	-	13/16	2	1 1/4	1 1/4	17/32
-	FL-3326	13/16	3 1/2	1 1/4	1 1/4	17/32

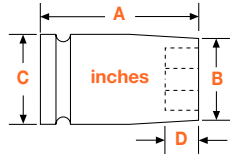

Surface Drive, Thin Wall, Long Length

Part No. Surface Drive	Hex Opening In.	Overall Length (A)	Diameter Nose End (B)	Diameter Drive End (C)	Opening Depth (D)
SF-3512	3/8	2	19/32	3/4	1/4
OSSF-3512*	3/8	2	19/32	19/32	1/4
SF-3514	7/16	2	5/8	3/4	9/32
OSSF-3514*	7/16	2	5/8	5/8	9/32
SF-3516	1/2	2	3/4	3/4	11/32
SF-3518	9/16	2	25/32	13/16	7/16
SF-3524	3/4	2	1	1	15/32

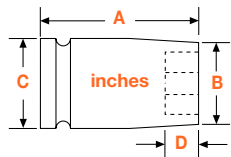





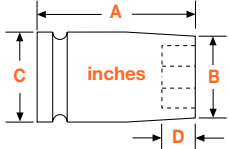

*No ring groove.

3/8" Square Drive Sockets For SAE Sheet Metal Screws







6 Point and 6 Point Magnetic, For Predrilled Holes*

Part Number 6 Point	Part Number Magnetic	Hex Opening In.	Overall Length (A)	Diameter Nose End (B)	Diameter Drive End (C)	Opening Depth (D)
3E06	-	3/16	1 1/4	5/16	3/4	3/32
3E07	-	7/32	1 1/4	3/8	3/4	5/32
3E08	M3E08 	1/4	1 1/4	7/16	3/4	5/32
-	M3E09 	9/32	1 1/4	7/16	3/4	3/16
3E10	M3E10 	5/16	1 1/4	1/2	3/4	3/16
3E11	M3E11	11/32	1 1/4	1/2	3/4	3/16
3E12	M3E12 	3/8	1 1/4	19/32	3/4	1/4
3E14	M3E14 	7/16	1 1/4	11/16	3/4	9/32
3E16	M3E16	1/2	1 1/2	13/16	13/16	11/32
3E18	M3E18	9/16	1 1/2	7/8	7/8	7/16

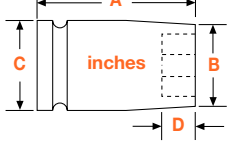
6 Point and 6 Point Magnetic, For Self-Tapping Screws*







Part Number 6 Point	Part Number Magnetic	Hex Opening In.	Overall Length (A)	Diameter Nose End (B)	Diameter Drive End (C)	Opening Depth (D)
3P06	M3P06	3/16	1 1/4	5/16	3/4	3/32
3P07	M3P07	7/32	1 1/4	3/8	3/4	5/32
3P08	M3P08	1/4	1 1/4	7/16	3/4	5/32
3P09	M3P09	9/32	1 1/4	7/16	3/4	3/16
3P10	M3P10 	5/16	1 1/4	1/2	3/4	3/16
3P11	M3P11	11/32	1 1/4	9/16	3/4	3/16
3P12	M3P12 	3/8	1 1/4	5/8	3/4	1/4
3P14	M3P14	7/16	1 1/4	11/16	3/4	9/32
3P16	M3P16 	1/2	1 1/2	13/16	13/16	11/32
3P18	M3P18	9/16	1 1/2	7/8	7/8	7/16

*Sockets for predrilled holes are intermediate hardness; sockets for self-tapping screws are maximum hardness.

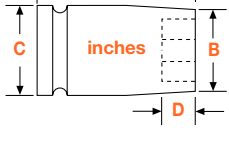
3/8" Square Drive Sockets For SAE Square Nuts

Single Square and Double Square

Part Number Square	Part No. Double Square	Square Opening In.	Overall Length (A)	Diameter Nose End (B)	Diameter Drive End (C)	Opening Depth (D)
3607	-	7/32	1 1/2	7/16	3/4	3/16
3608	3608-D	1/4	1 1/2	1/2	3/4	3/16
3609	3609-D	9/32	1 1/2	9/16	3/4	3/16
3610 	3610-D	5/16	1 1/2	5/8	3/4	1/4
3612 	3612-D	3/8	1 1/2	3/4	3/4	1/4
3614	3614-D	7/16	1 1/2	7/8	7/8	9/32
3616	3616-D	1/2	1 1/2	1	1	11/32
3618	3618-D	9/16	1 1/2	1	1	7/16
3620	-	5/8	1 1/2	1 1/8	1 1/8	7/16
3622	-	11/16	1 1/2	1 1/4	1 1/4	7/16
3624	-	3/4	1 1/2	1 3/8	1 3/8	15/32

 Refer to Page iv for description of Rapid Select.

3/8" Square Drive Socket Sets, SAE



6 Point



APS38	8 piece, standard length: 5/16, 3/8, 7/16, 1/2, 9/16, 5/8, 11/16, 3/4
APS38L	8 piece, long length: 5/16, 3/8, 7/16, 1/2, 9/16, 5/8, 11/16, 3/4

3/8" Square Drive Universal Wrenches, SAE

6 Point and 12 Point

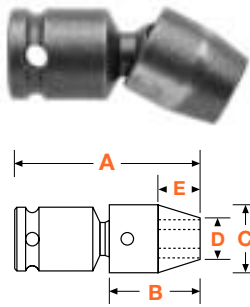

Part Number 6 Point	Part Number 12 Point	Hex Opening In.	Overall Length (A) In.	Socket Length (B) In.	Socket Diameter (C) In.	Nose End Diameter (D) In.	Clearance Depth (E) In.
SA-120	SA-120-D	5/16	1 53/64	3/4	3/4	7/16	5/16
SA-122	SA-122-D	3/8	1 57/64	13/16	3/4	9/16	3/8
SA-200	-	3/8	1 15/16	7/8	7/8	9/16	11/32
SA-123	SA-123-D	7/16	2 1/64	15/16	3/4	19/32	1/2
SA-201	-	7/16	2	15/16	7/8	5/8	13/32
SA-124	SA-124-D	1/2	2 5/64	1	3/4	3/4	9/16
SA-202	SA-202-D	1/2	2 1/16	1	7/8	11/16	15/32
SA-301	-	1/2	2 1/16	1	1	11/16	7/16
SA-125	SA-125-D	9/16	2 1/8	1	13/16	13/16	9/16
SA-203	SA-203-D	9/16	2 1/16	1 1/16	7/8	3/4	17/32
SA-302	-	9/16	2 1/8	1 1/8	1	3/4	9/16
SA-205	SA-205-D	5/8	2 1/8	1 1/8	7/8	7/8	19/32
SA-304	-	5/8	2 3/16	1 3/16	1	27/32	5/8
SA-305	-	11/16	2 5/16	1 1/4	1	1	11/16
SA-306	SA-306-D	3/4	2 5/16	1 1/4	1 1/8	1 1/8	11/16

Universal wrenches must not be used with impact drivers. Maximum operating angle is 30°.

3/8" Square Drive Universal Wrench Set, SAE

6 Point







APU37	7 piece, standard length: 3/8, 7/16, 1/2, 9/16, 5/8, 11/16, 3/4
-------	---

3/8" Square Drive Universal Wrenches, SAE - Extension



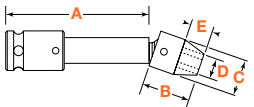
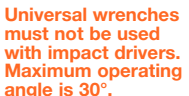







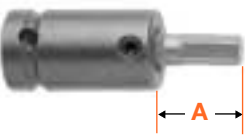













6 Point and Double Hex, Standard and Tension Type

	Part Number Standard	Part Number Tension	Hex Opening In.	Overall Length (A) In.	Socket Length (B) In.	Socket Diameter (C) In.	Nose End Diameter (D) In.	Clearance Depth (E) In.
	KA-43-3	-	3/8	3	13/16	5/8	17/32	7/16
	KA-43-4	-	3/8	4	13/16	5/8	17/32	7/16
	KA-43-6	KD-43-6	3/8	6	13/16	5/8	17/32	7/16
	-	KD-43-9	3/8	9	13/16	5/8	17/32	7/16
	KA-44-3	-	7/16	3	7/8	5/8	5/8	1/2
	KA-44-4	-	7/16	4	7/8	5/8	5/8	1/2
	KA-44-6	KD-44-6	7/16	6	7/8	5/8	5/8	1/2
	-	KD-44-9	7/16	9	7/8	5/8	5/8	1/2
	-	KD-44-12	7/16	12	7/8	5/8	5/8	1/2
	KA-103-3	-	7/16	3	15/16	3/4	19/32	1/2
	KA-103-4	-	7/16	4	15/16	3/4	19/32	1/2
	KA-103-6	KD-103-6	7/16	6	15/16	3/4	19/32	1/2
	KA-45-3	-	1/2	3	7/8	11/16	11/16	1/2
	KA-45-4	-	1/2	4	7/8	11/16	11/16	1/2
	KA-45-6	KD-45-6	1/2	6	7/8	11/16	11/16	1/2
	KA-45-9	KD-45-9	1/2	9	7/8	11/16	11/16	1/2
	KA-45-12	KD-45-12	1/2	12	7/8	11/16	11/16	1/2
	KA-104-3	-	1/2	3	1	3/4	3/4	9/16
	KA-104-4	-	1/2	4	1	3/4	3/4	9/16
	KA-104-6	KD-104-6	1/2	6	1	3/4	3/4	9/16
	KA-104-9	-	1/2	9	1	3/4	3/4	9/16
KA-104-12	KD-104-12	1/2	12	1	3/4	3/4	9/16	
KA-105-3	KD-105-3	9/16	3	1	13/16	13/16	9/16	
KA-105-4	KD-105-4	9/16	4	1	13/16	13/16	9/16	
KA-105-6	KD-105-6 	9/16	6	1	13/16	13/16	9/16	
KA-105-9	KD-105-9	9/16	9	1	13/16	13/16	9/16	
KA-105-12	KD-105-12	9/16	12	1	13/16	13/16	9/16	
KA-205-3	-	5/8	3	1 1/8	7/8	7/8	19/32	
KA-205-6	KD-205-6	5/8	6	1 1/8	7/8	7/8	19/32	
	-	KD-205-12	5/8	12	1 1/8	7/8	19/32	

3/8" Sq. Dr. Socket Head Bits, SAE

Complete, Adapter Only, Insert Only

	Part Number			Hex Size	Overall Length	Length of Insert (A)		
	Complete	Adapter Only	Insert Only			In.	mm	In.
	SZ-10 	SC-314 	SZ-10-A 	1/8	2 1/4	57	1 3/8	35
	SZ-11 	SC-314 	SZ-11-A 	5/32	2 1/4	57	1 3/8	35
	SZ-12 	SC-314 	SZ-12-A 	3/16	2 1/4	57	1 3/8	35
	SZ-13 	SC-314 	SZ-13-A 	7/32	2 1/4	57	1 3/8	35
	SZ-14 	SC-314 	SZ-14-A 	1/4	2 1/4	57	1 3/8	35
	SZ-15 	SC-314 	SZ-15-A 	5/16	2 1/4	57	1 3/8	35
	SZ-16 	SC-314 	SZ-16-A 	3/8	2 1/4	57	1 3/8	35

See page 35 for more 3/8" drive complete socket head bits.

 Refer to Page iv for description of Rapid Select.

3/8" Square Drive Sockets, Metric

6 Point and 12 Point, Short and Standard Length

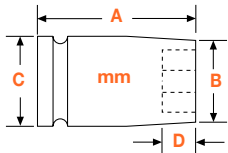

Part Number 6 Point	Part Number 12 Point	Hex Opening mm	Overall Length (A)	Diameter Nose End (B)	Diameter Drive End (C)	Opening Depth (D)
6mm13	-	6	31.7	11.1	19.1	3.9
7mm03	-	7	22.2	11.1	19.1	3.0
7mm13	-	7	31.7	11.1	19.1	4.8
8mm03	-	8	22.2	12.7	19.1	4.8
8mm13	8mm13-D	8	31.7	12.7	19.1	4.8
OS-8mm13*	-	8	31.7	11.7	15.7	4.8
9mm03	9mm03-D	9	22.2	15.1	19.1	4.8
9mm13	9mm13-D	9	31.7	15.1	19.1	4.8
10mm03	10mm03-D	10	22.2	16.8	19.1	6.4
OS-10mm03*	-	10	22.1	15.7	15.7	6.4
10mm13	10mm13-D	10	31.7	16.8	19.1	6.4
11mm03	11mm03-D	11	22.2	17.5	19.1	7.2
11mm13	11mm13-D	11	31.7	17.5	19.1	7.2
12mm03	12mm03-D	12	22.2	19.1	19.1	7.2
12mm13	12mm13-D	12	38.1	19.1	19.1	7.2
13mm03	13mm03-D	13	22.2	20.6	20.6	7.9
13mm13	13mm13-D	13	38.1	20.6	20.6	8.7
14mm03	14mm03-D	14	22.2	22.2	22.2	7.9
14mm13	14mm13-D	14	38.1	22.2	22.2	11.1
15mm03	15mm03-D	15	23.8	22.2	22.2	9.5
15mm13	15mm13-D	15	38.1	22.2	22.2	11.1
16mm03	16mm03-D	16	25.4	23.8	23.8	11.1
16mm13	16mm13-D	16	38.1	23.8	23.8	11.1
17mm03	17mm03-D	17	25.4	25.4	25.4	11.1
17mm13	17mm13-D	17	38.1	25.4	25.4	11.1
18mm03	18mm03-D	18	25.4	25.4	25.4	11.1
18mm13	18mm13-D	18	38.1	25.4	25.4	11.1
19mm03	19mm03-D	19	25.4	28.6	28.6	11.1
19mm13	19mm13-D	19	38.1	28.6	28.6	11.9
20mm03	-	20	25.4	28.6	28.6	11.1
20mm13	-	20	38.1	28.6	28.6	11.9
21mm03	-	21	25.4	31.7	31.7	11.1
21mm13	-	21	38.1	31.7	31.7	13.5
22mm03	-	22	25.4	31.7	31.7	11.1
22mm13	-	22	38.1	31.7	31.7	14.3

*No ring groove.

3/8" Square Drive Sockets, Metric



6 Point and Double Hex, Thin Wall, Standard Length

Part Number 6 Point	Part Number Double Hex	Hex Opening mm	Overall Length (A)	Diameter Nose End (B)	Diameter Drive End (C)	Opening Depth (D)
6mm43	-	6	31.7	9.5	19.1	3.9
7mm43	7mm43-D	7	31.7	11.1	19.1	4.8
8mm43	8mm43-D	8	31.7	12.7	19.1	4.8
9mm43	9mm43-D	9	31.7	12.7	19.1	4.8
10mm43	10mm43-D	10	31.7	15.1	19.1	6.4
11mm43	11mm43-D	11	38.1	15.9	19.1	7.2
12mm43	12mm43-D	12	38.1	17.5	19.1	7.2
13mm43	13mm43-D	13	38.1	19.1	19.1	8.7
14mm43	14mm43-D	14	38.1	19.8	20.6	11.1
15mm43	15mm43-D	15	38.1	20.6	20.6	11.1
16mm43	16mm43-D	16	38.1	22.2	22.2	11.1
17mm43	17mm43-D	17	38.1	23.8	23.8	11.1
18mm43	18mm43-D	18	38.1	23.8	23.8	11.1
19mm43	19mm43-D	19	38.1	25.4	25.4	11.9

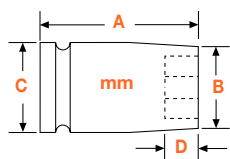

6 Point and Double Hex, Long and Extra Long Length

Part Number 6 Point	Part Number Double Hex	Hex Opening mm	Overall Length (A)	Diameter Nose End (B)	Diameter Drive End (C)	Opening Depth (D)
6mm23	-	6	50.8	11.1	19.1	3.9
7mm23	-	7	50.8	11.1	19.1	4.8
8mm23	8mm23-D	8	50.8	12.7	19.1	4.8
9mm23	9mm23-D	9	50.8	15.1	19.1	4.8
10mm23	10mm23-D	10	50.8	16.8	19.1	6.4
OS-10mm23*	OS-10mm23-D*	10	50.8	14.2	15.9	6.4
10mm33	-	10	88.9	16.8	19.1	6.4
11mm23	11mm23-D	11	50.8	17.5	19.1	7.2
12mm23	12mm23-D	12	50.8	19.1	19.1	7.2
13mm23	13mm23-D	13	50.8	20.6	20.6	8.7
13mm33	-	13	88.9	20.6	20.6	8.7
14mm23	14mm23-D	14	50.8	22.2	22.2	11.1
15mm23	15mm23-D	15	50.8	22.2	22.2	11.1
15mm33	15mm33-D	15	88.9	22.2	22.2	11.1
16mm23	16mm23-D	16	50.8	23.8	23.8	11.1
17mm23	17mm23-D	17	50.8	25.4	25.4	11.1
18mm23	18mm23-D	18	50.8	25.4	25.4	11.1
19mm23	19mm23-D	19	50.8	28.6	28.6	11.9
20mm23	20mm23-D	20	50.8	28.6	28.6	11.9
21mm23	-	21	50.8	31.7	31.7	13.5
22mm23	-	22	50.8	31.7	31.7	14.3

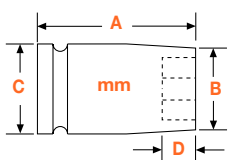

*No ring groove.

3/8" Square Drive Sockets, Metric



Magnetic, Short and Standard Length

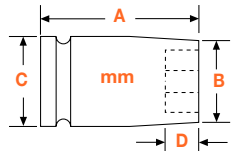

Part Number Fixed Magnet	Hex Opening mm	Overall Length (A)	Diameter Nose End (B)	Diameter Drive End (C)	Opening Depth (D)
M-6mm13	6	31.8	11.1	19.1	3.9
M-7mm13	7	31.8	11.1	19.1	4.8
M-8mm13	8	31.8	12.7	19.1	4.8
M-9mm13	9	31.8	15.1	19.1	4.8
M-10mm03	10	22.2	16.8	19.1	6.4
M-10mm13	10	31.8	16.8	19.1	6.4
M-11mm03	11	22.2	17.5	19.1	7.2
M-11mm13	11	38.1	17.5	19.1	7.2
M-12mm03	12	22.2	19.1	19.1	7.2
M-12mm13	12	38.1	19.1	19.1	7.2
M-13mm03	13	22.2	20.6	20.6	8.7
M-13mm13	13	38.1	20.6	20.6	8.7
M-14mm13	14	38.1	22.2	22.2	11.1
M-15mm03	15	23.8	22.2	22.2	9.5
M-15mm13	15	38.1	22.2	22.2	11.1
M-16mm13	16	38.1	23.8	23.8	11.1
M-17mm13	17	38.1	25.4	25.4	11.1
M-18mm03	18	25.4	25.4	25.4	11.1
M-18mm13	18	38.1	25.4	25.4	11.1

Magnetic, Thin Wall, Standard Length

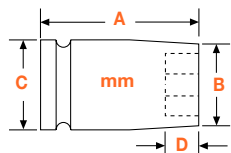

Part Number Fixed Magnet	Hex Opening mm	Overall Length (A)	Diameter Nose End (B)	Diameter Drive End (C)	Opening Depth (D)
M-6mm43	6	31.7	9.5	19.1	3.9
M-8mm43	8	31.7	12.7	19.1	4.8
M-9mm43	9	31.7	12.7	19.1	4.8
M-10mm43	10	31.7	15.1	19.1	6.4
M-11mm43	11	38.1	15.9	19.1	7.2
M-12mm43	12	38.1	17.5	19.1	7.2
M-13mm43	13	38.1	19.1	19.1	8.7
M-14mm43	14	38.1	19.8	20.6	11.1
M-15mm43	15	38.1	20.5	20.6	11.1

3/8" Square Drive Sockets, Metric



Magnetic, Long and Extra Long Length

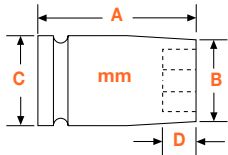

Part Number Magnetic Bolt Clearance	Hex Opening mm	Overall Length (A)	Diameter Nose End (B)	Diameter Drive End (C)	Opening Depth (D)
MB-6mm23	6	50.8	11.1	19.1	3.9
MB-7mm23	7	50.8	11.1	19.1	4.8
MB-8mm23	8	50.8	12.7	19.1	4.8
OSMB-8mm23*	8	50.8	11.7	15.9	4.8
MB-9mm23	9	50.8	15.1	19.1	4.8
MB-10mm23	10	50.8	16.8	19.1	6.4
OSMB-10mm23*	10	50.8	14.2	15.9	6.4
MB-10mm33	10	88.9	16.8	19.1	6.4
MB-11mm23	11	50.8	17.5	19.1	7.2
MB-12mm23	12	50.8	19.1	19.1	7.2
MB-13mm23	13	50.8	20.6	20.6	8.7
MB-13mm33	13	88.9	20.6	20.6	8.7
MB-14mm23	14	50.8	22.2	22.2	11.1
MB-15mm23	15	50.8	22.2	22.2	11.1
MB-15mm33	15	88.9	22.2	22.2	11.1
MB-16mm23	16	50.8	23.8	23.8	11.1
MB-17mm23	17	50.8	25.4	25.4	11.1
MB-18mm23	18	50.8	25.4	25.4	11.1

*No ring groove.

Surface Drive, Short and Standard Length

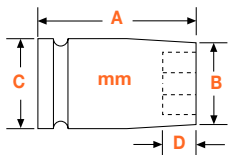

Part Number Surface Drive	Hex Opening mm	Overall Length (A)	Diameter Nose End (B)	Diameter Drive End (C)	Opening Depth (D)
SF-8mm13	8	31.7	12.7	19.1	4.8
SF-9mm13	9	31.7	15.1	19.1	4.8
SF-10mm03	10	22.2	16.8	19.1	6.4
SF-10mm13	10	31.7	16.8	19.1	6.4
SF-11mm03	11	22.2	17.5	19.1	7.2
SF-11mm13	11	38.1	17.5	19.1	7.2
SF-12mm03	12	22.2	19.1	19.1	7.2
SF-12mm13	12	38.1	19.1	19.1	7.2
SF-13mm03	13	22.2	20.6	20.6	8.7
SF-13mm13	13	38.1	20.6	20.6	8.7
SF-14mm03	14	22.2	22.2	22.2	11.1
SF-14mm13	14	38.1	22.2	22.2	11.1
SF-15mm03	15	23.8	22.2	22.2	11.1
SF-15mm13	15	38.1	22.2	22.2	11.1
SF-16mm13	16	38.1	23.8	23.8	11.1
SF-17mm03	17	25.4	25.4	25.4	11.1
SF-17mm13	17	38.1	25.4	25.4	11.1
SF-18mm03	18	25.4	25.4	25.4	11.1
SF-18mm13	18	38.1	25.4	25.4	11.1
SF-19mm03	18	25.4	28.6	28.6	11.9
SF-19mm13	18	38.1	28.6	28.6	11.9

3/8" Square Drive Sockets, Metric

Surface Drive, Thin Wall, Standard Length

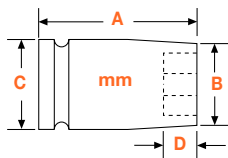

Part Number Surface Drive	Hex Opening mm	Overall Length (A)	Diameter Nose End (B)	Diameter Drive End (C)	Opening Depth (D)
SF-10mm43	10	31.7	15.1	19.1	6.4
OSSF-10mm43*	10	31.7	15.1	15.1	6.4
SF-11mm43	11	38.1	15.9	19.1	7.2
SF-12mm43	12	38.1	17.5	19.1	7.2
SF-13mm43	13	38.1	19.1	19.1	8.7
SF-15mm43	15	38.1	20.6	20.6	11.1
SF-16mm43	16	38.1	22.2	22.2	11.1
SF-17mm43	17	38.1	23.8	23.8	11.1
SF-18mm43	18	38.1	23.8	23.8	11.1
SF-19mm43	19	38.1	25.4	25.4	11.9

Surface Drive, Long and Extra Long Length

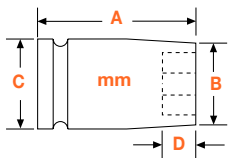

Part Number Surface Drive	Hex Opening mm	Overall Length (A)	Diameter Nose End (B)	Diameter Drive End (C)	Opening Depth (D)
SF-8mm23	8	50.8	12.7	19.1	4.8
OSSF-8mm23*	8	50.8	11.9	15.9	4.8
SF-10mm23	10	50.8	16.8	19.1	6.4
OSSF-10mm23*	10	50.8	14.2	15.9	6.4
SF-10mm33	10	88.9	16.8	19.1	6.4
SF-11mm23	11	50.8	17.5	19.1	7.2
SF-12mm23	12	50.8	19.1	19.1	7.2
SF-13mm23	13	50.8	20.6	20.6	8.7
SF-13mm33	13	88.9	20.6	20.6	8.7
SF-15mm23	15	50.8	22.2	22.2	11.1
SF-15mm33	15	88.9	22.2	22.2	11.1
SF-17mm23	17	50.8	25.4	25.4	11.1
SF-18mm23	18	50.8	25.4	25.4	11.1
SF-19mm23	19	50.8	28.6	28.6	11.9

*No ring groove.

3/8" Sq. Dr. Sockets For Metric Sheet Metal Screws

6 Point and 6 Point Magnetic, for Predrilled Holes

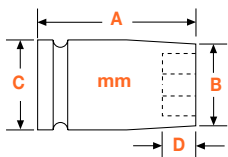

Part Number 6 Point	Part Number Magnetic	Hex Opening mm	Overall Length (A)	Diameter Nose End (B)	Diameter Drive End (C)	Opening Depth (D)
6mmE3	M-6mmE3	6	31.7	11.1	19.1	3.9
7mmE3	M-7mmE3	7	31.7	11.9	19.1	4.8
8mmE3	M-8mmE3	8	31.7	12.7	19.1	4.8
9mmE3	M-9mmE3	9	31.7	15.1	19.1	4.8
10mmE3	M-10mmE3	10	31.7	16.8	19.1	6.4
11mmE3	M-11mmE3	11	31.7	17.5	19.1	7.2
12mmE3	M-12mmE3	12	31.7	19.1	19.1	7.2
13mmE3	M-13mmE3	13	38.1	20.6	20.6	8.7

Refer to Page iv for description of Rapid Select.

3/8" Square Drive Socket Sets, Metric



6 Point



APS38M

8 piece, standard length: 8mm, 9mm, 10mm, 11mm, 12mm, 13mm, 14mm, 15mm

APS312M

12 piece, standard length: 7mm, 8mm, 9mm, 10mm, 11mm, 12mm, 13mm, 14mm, 15mm, 16mm, 17mm, 18mm

APS38LM

8 piece, long length: 8mm, 9mm, 10mm, 11mm, 12mm, 13mm, 14mm, 15mm

APS312LM

12 piece, long length: 7mm, 8mm, 9mm, 10mm, 11mm, 12mm, 13mm, 14mm, 15mm, 16mm, 17mm, 18mm

Universal Wrenches 3/8" Square Drive, Metric

6 Point

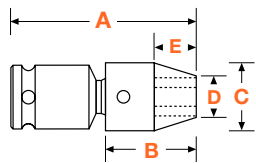

Part Number 6 Point	Hex Opening mm	Overall Length (A) mm	Socket Length (B) mm	Socket Diameter (C) mm	Nose End Diameter (D) mm	Clearance Depth (E) mm
SA-36-10m	10	48	20.6	19.1	15.1	9.5
SA-37-11m	11	51	23.8	22.2	15.9	10.3
SA-37-12m	12	51	23.8	22.2	17.5	10.3
SA-37-13m	13	52	25.4	22.2	17.5	11.9
SA-37-14m	14	54	27.0	22.2	19.1	13.5
SA-38-15m	15	56	28.6	25.4	19.8	14.3
SA-38-17m	17	59	31.8	25.4	25.4	17.5
SA-38-18m	18	59	31.8	25.4	25.4	17.5

Universal wrenches must not be used with impact drivers. Maximum operating angle is 30°.

3/8" Square Drive Universal Wrench Set, Metric

6 Point









APU37M

7 piece, standard length: 10mm, 12mm, 13mm, 14mm, 15mm, 17mm, 18mm

3/8" Square Drive Universal Wrenches, Metric – Extension

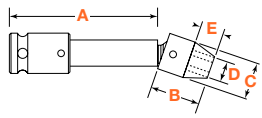







6 Point, Standard and Tension Type

	Part Number Standard	Part Number Tension	Hex Opening mm	Shank Length (A) mm	Socket Length (B) mm	Socket Diameter (C) mm	Nose End Diameter (D) mm	Clearance Depth (E) mm
	KA-6-10m-3	-	10	76	20.6	19.1	15.1	9.5
	KA-6-10m-4	-	10	102	20.6	19.1	15.1	9.5
	KA-6-10m-6	KD-6-10m-6 	10	152	20.6	19.1	15.1	9.5
	KA-6-10m-9	KD-6-10m-9	10	229	20.6	19.1	15.1	9.5
	KA-6-10m-12	KD-6-10m-12	10	305	20.6	19.1	15.1	9.5
	KA-7-11m-3	-	11	76	23.8	22.2	15.9	10.3
	KA-7-11m-6	KD-7-11m-6	11	152	23.8	22.2	15.9	10.3
	-	KD-7-11m-9	11	229	23.8	22.2	15.9	10.3
	KA-7-11m-12	KD-7-11m-12	11	305	23.8	22.2	15.9	10.3
	KA-7-12m-3	-	12	76	23.8	22.2	17.5	10.3
	KA-7-12m-4	-	12	102	23.8	22.2	17.5	10.3
	KA-7-12m-6	KD-7-12m-6	12	152	23.8	22.2	17.5	10.3
	KA-7-12m-9	KD-7-12m-9	12	229	23.8	22.2	17.5	10.3
	KA-7-12m-12	KD-7-12m-12	12	305	23.8	22.2	17.5	10.3
	KA-7-13m-3	-	13	76	25.4	22.2	17.5	11.9
	KA-7-13m-4	-	13	102	25.4	22.2	17.5	11.9
	KA-7-13m-6 	KD-7-13m-6 	13	152	25.4	22.2	17.5	11.9
	KA-7-13m-9	KD-7-13m-9	13	229	25.4	22.2	17.5	11.9
	KA-7-13m-12	KD-7-13m-12	13	305	25.4	22.2	17.5	11.9
	KA-7-14m-3	-	14	76	27.0	22.2	19.1	13.5
	KA-7-14m-4	-	14	102	27.0	22.2	19.1	13.5
	KA-7-14m-6	KD-7-14m-6 	14	152	27.0	22.2	19.1	13.5
	KA-7-14m-9	KD-7-14m-9	14	229	27.0	22.2	19.1	13.5
	KA-7-14m-12	-	14	305	27.0	22.2	19.1	13.5
	KA-8-15m-3	-	15	76	28.6	25.4	19.8	14.3
	KA-8-15m-4	-	15	102	28.6	25.4	19.8	14.3
	KA-8-15m-6	KD-8-15m-6 	15	152	28.6	25.4	19.8	14.3
	KA-8-15m-9	KD-8-15m-9	15	229	28.6	25.4	19.8	14.3
	KA-8-15m-12	KD-8-15m-12	15	305	28.6	25.4	19.8	14.3

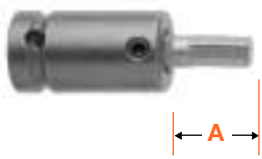
Universal wrenches must not be used with impact drivers. Maximum operating angle is 30°.

3/8" Square Drive Socket Head Bits, Metric

Complete, Adapter Only, Insert Only

	Part Number			Hex Size	Overall Length		Length of Insert (A)	
	Complete	Adapter Only	Insert Only		In.	mm	In.	mm
	SZ-3-7-4mm	SC-314 	SZ-7-4mm	4mm	2 1/4	57	1 3/8	35
	SZ-3-7-5mm	SC-314 	SZ-7-5mm	5mm	2 1/4	57	1 3/8	35
	SZ-3-7-6mm	SC-314 	SZ-7-6mm 	6mm	2 1/4	57	1 3/8	35
	SZ-3-7-8mm	SC-314 	SZ-7-8mm	8mm	2 1/4	57	1 3/8	35
	SZ-3-7-10mm	SC-314 	SZ-7-10mm	10mm	2 1/4	57	1 3/8	35

3/8" Square Drive Sockets For Spline Fasteners



Standard and Long Length

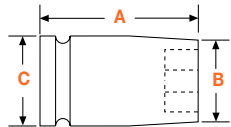

Part Number	Spline Size	Nominal Size	Overall Length (A)		Diameter Nose End (B)		Diameter Drive End (C)	
			In.	mm	In.	mm	In.	mm
CMS-3412	12	3/8	1	25	17/32	14	21/32	17
CMS-3512	12	3/8	2 1/8	54	17/32	14	21/32	17
CMS-3414	14	7/16	1 1/16	27	5/8	16	11/16	18
CMS-3514	14	7/16	2 1/8	54	5/8	16	11/16	18
CMS-3416	16	1/2	1 1/16	27	23/32	18	23/32	18
CMS-3418	18	9/16	1 1/16	27	13/16	21	13/16	21
CMS-3518	18	9/16	2 3/8	60	13/16	21	13/16	21
CMS-3420	20	5/8	1 3/16	30	7/8	22	7/8	22
CMS-3520	20	5/8	2 3/8	60	7/8	22	7/8	22

Apex spline sockets conform to military specifications MS-37787 and MIL-W-8982C.

3/8" Square Drive Torx® Sockets

For External Torx Screws

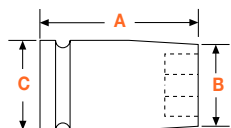

Part Number	Driver Size	Overall Length (A)		Nose End Diameter (B)		Drive End Diameter (C)	
		In.	mm	In.	mm	In.	mm
TX-3106	E-6	1 1/4	32	3/8	10	3/4	19
TX-3107	E-7	1 1/4	32	3/8	10	3/4	19
TX-3108	E-8	1 1/4	32	7/16	11	3/4	19
TX-3110	E-10	1 1/4	32	1/2	13	3/4	19
TX-3112	E-12	1 1/4	32	5/8	16	3/4	19
TX-3114	E-14	1 1/4	32	11/16	18	3/4	19
TX-3116	E-16	1 1/4	32	13/16	21	13/16	21

For External Torx Screws, Thin Wall

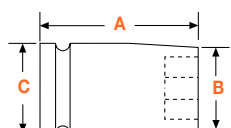

Part Number	Driver Size	Overall Length (A)		Nose End Diameter (B)		Drive End Diameter (C)	
		In.	mm	In.	mm	In.	mm
TX-3406	E-6	1 1/4	32	5/16	8	5/8	16
TX-3407	E-7	1 1/4	32	11/32	9	5/8	16
TX-3408	E-8	1 1/4	32	3/8	10	5/8	16
TX-3508	E-8	2	51	3/8	10	5/8	16
TX-3410	E-10	1 1/4	32	1/2	13	5/8	16
TX-3412	E-12	1 1/4	32	9/16	14	5/8	16
TX-3414	E-14	1 1/4	32	5/8	16	3/4	19
TX-3416	E-16	1 1/4	32	3/4	19	3/4	19

Some Torx® sockets have a DIN (pin and o-ring) groove.

3/8" Square Drive Torx® Sockets



For Torx Nuts

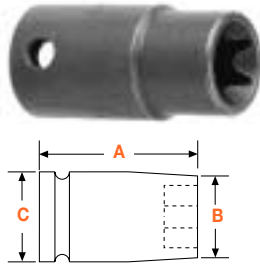

Part Number	Driver Size	Overall Length (A)		Nose End Diameter (B)		Drive End Diameter (C)	
		In.	mm	In.	mm	In.	mm
TX-3E08	E-8	1 1/4	32	5/8	16	5/8	16
TX-3E10	E-10	1 1/4	32	5/8	16	5/8	16
TX-3E12	E-12	1 1/4	32	11/16	17	11/16	17
TX-3E14	E-14	1 1/4	32	3/4	19	3/4	19
TX-3E16	E-16	1 1/4	32	13/16	21	13/16	21

Sockets for Torx® nuts have a larger lead-in chamfer than sockets for external Torx® screws. Some Torx® sockets have a DIN (pin and o-ring) groove.

3/8" Square Drive Extensions

1 1/4" to 18" (32mm to 457mm) Length



Part Number	Male Square In.	Type of Lock	Overall Length	
			In.	mm
EX-374	3/8	Pin	1 3/8	34
EX-374-B	3/8	Ball	1 3/8	34
EX-376-2	3/8	Pin	2	51
EX-376-B-2	3/8	Ball	2	51
EX-376-3	3/8	Pin	3	76
EX-376-B-3	3/8	Ball	3	76
EX-376-4	3/8	Pin	4	102
EX-376-B-4	3/8	Ball	4	102
EX-376-5	3/8	Pin	5	127
EX-376-B-5	3/8	Ball	5	127
EX-376-6	3/8	Pin	6	152
EX-376-B-6	3/8	Ball	6	152
EX-376-8	3/8	Pin	8	203
EX-376-B-8	3/8	Ball	8	203
EX-376-9	3/8	Pin	9	229
EX-376-B-9	3/8	Ball	9	229
EX-376-10	3/8	Pin	10	254
EX-376-B-10	3/8	Ball	10	254
EX-376-12	3/8	Pin	12	305
EX-376-B-12	3/8	Ball	12	305
EX-376-15	3/8	Pin	15	381
EX-376-B-15	3/8	Ball	15	381
EX-376-18	3/8	Pin	18	457

3/8" Square Drive Adapters



1/4" to 3/4" Male Square



Part Number	Male Square In.	Female Square In.	Type of Lock	Overall Length	
				In.	mm
EX-254	1/4	3/8	Pin	1 1/4	32
EX-254-B	1/4	3/8	Ball	1 1/4	32
EX-257-2	1/4	3/8	Pin	2	51
EX-257-B-2	1/4	3/8	Ball	2	51
EX-257-3	1/4	3/8	Pin	3	76
EX-257-B-3	1/4	3/8	Ball	3	76
EX-257-4	1/4	3/8	Pin	4	102
EX-257-B-4	1/4	3/8	Ball	4	102
EX-257-5	1/4	3/8	Pin	5	127
EX-257-B-5	1/4	3/8	Ball	5	127
EX-257-6	1/4	3/8	Pin	6	152
EX-257-B-6	1/4	3/8	Ball	6	152
EX-503	1/2	3/8	Pin	1 1/2	38
EX-503-B	1/2	3/8	Ball	1 1/2	38
EX-507-2	1/2	3/8	Pin	2	51
EX-507-3	1/2	3/8	Pin	3	76
EX-507-B-3	1/2	3/8	Ball	3	76
EX-507-4	1/2	3/8	Pin	4	102
EX-507-B-4	1/2	3/8	Ball	4	102
EX-507-6	1/2	3/8	Pin	6	152
EX-507-B-6	1/2	3/8	Ball	6	152
EX-622	5/8	3/8	Pin	1 1/2	38
EX-750	3/4	3/8	7/32 Drill Hole	1 1/2	38
EX-750-B	3/4	3/8	Ball	1 1/2	38

3/8" Square Drive Universal Adapters

Male Square to Female Square



Universal wrenches must not be used with impact drivers. Maximum operating angle is 30°.

Part Number	Male Square In.	Female Square In.	Type of Lock	Overall Length		Largest Diameter	
				In.	mm	In.	mm
MF-27	1/4	3/8	Pin	1 5/16	49	3/4	19
MF-27B	1/4	3/8	Ball	1 5/16	49	3/4	19
MF-37	3/8	3/8	Pin	2 1/8	54	3/4	19
MF-37B	3/8	3/8	Ball	2 1/8	54	3/4	19
MF-38	3/8	3/8	Pin	2 1/2	64	7/8	22
MF-38B	3/8	3/8	Ball	2 1/2	64	7/8	22

3/8" Square Drive Universal Adapters - Extension

Male Square to Female Square



(Standard Type Shown)

Standard lengths are 3", 6", 9" and 12" (76, 152, 229 and 305mm)

Standard	Part Number	Male Square In.	Female Square In.	Type of Lock	Largest Diameter		
	Tension				In.	mm	
	KAM-25-3	1/4	3/8	Pin	5/8	16	
	KAM-37-3	3/8	3/8	Pin	3/4	19	
	-	KAM-37-6	3/8	3/8	Pin	3/4	19
	KAM-37-B-3	KDM-37-B-3	3/8	3/8	Ball	3/4	19
	KAM-38-6	KDM-38-6	3/8	3/8	Pin	7/8	22

Refer to Page iv for description of Rapid Select.

1/2" Square Drive Sockets, SAE



6 Point and Double Hex, Standard Length

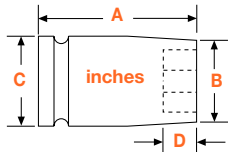

Part Number 6 Point	Part Number Double Hex	Hex Opening In.	Overall Length (A)	Diameter Nose End (B)	Diameter Drive End (C)	Opening Depth (D)
5108	5108-D	1/4	1 1/2	7/16	15/16	5/32
5109	-	9/32	1 1/2	7/16	15/16	3/16
5110	5110-D	5/16	1 1/2	1/2	15/16	3/16
5111	-	11/32	1 1/2	9/16	15/16	3/16
5112	5112-D	3/8	1 1/2	5/8	15/16	1/4
5113	5113-D	13/32	1 1/2	11/16	15/16	1/4
5114	5114-D	7/16	1 1/2	11/16	15/16	9/32
5115	-	15/32	1 1/2	3/4	15/16	9/32
5116	5116-D	1/2	1 1/2	13/16	15/16	11/32
SH-335	SH-335-D	1/2	1 1/2	45/64	15/16	11/32
5117	-	17/32	1 1/2	7/8	15/16	11/32
5118	5118-D	9/16	1 1/2	7/8	15/16	7/16
SH-336	SH-336-D	9/16	1 1/2	27/32	15/16	7/16
5119	5119-D	19/32	1 1/2	15/16	15/16	7/16
5120	5120-D	5/8	1 1/2	1	1	7/16
SH-338	SH-338-D	5/8	1 1/2	15/16	1	7/16
5121	-	21/32	1 1/2	1	1	7/16
5122	5122-D	11/16	1 1/2	1 1/8	1 1/8	7/16
SH-339	SH-339-D	11/16	1 1/2	1 1/64	1 1/16	7/16
SW-282	SW-282-D	3/4	1 1/2	1 1/4	1 1/4	15/32
5124	5124-D	3/4	1 1/2	1 1/8	1 1/8	15/32
5125	5125-D	25/32	1 1/2	1 1/4	1 1/4	15/32
5126	5126-D	13/16	1 1/2	1 1/4	1 1/4	17/32
5128	5128-D	7/8	1 1/2	1 5/16	1 5/16	9/16
5129	5129-D	29/32	1 1/2	1 3/8	1 3/8	5/8
5130	5130-D	15/16	1 1/2	1 3/8	1 3/8	5/8
5131	5131-D	31/32	1 1/2	1 1/2	1 1/2	5/8
5132	5132-D	1	1 1/2	1 1/2	1 1/2	5/8
5134	5134-D	1 1/16	1 5/8	1 1/2	1 1/2	11/16
5136	5136-D	1 1/8	1 5/8	1 5/8	1 5/8	3/4
5138	5138-D	1 3/16	1 5/8	1 3/4	1 3/4	3/4
5140	5140-D	1 1/4	1 3/4	1 3/4	1 3/4	13/16
5142	5142-D	1 5/16	1 3/4	1 7/8	1 7/8	13/16
5144	5144-D	1 3/8	1 7/8	2	2	13/16
5146	5146-D	1 7/16	2	2	2	15/16
5148	5148-D	1 1/2	2	2 1/8	2 1/8	1
5150	5150-D	1 9/16	2	2 1/4	2 1/4	1
5152	5152-D	1 5/8	2	2 3/8	2 3/8	1 1/8
5154	5154-D	1 11/16	2	2 3/8	2 3/8	1 1/8
5156	5156-D	1 3/4	2	2 1/2	2 1/2	1 1/8

Refer to Page iv for description of Rapid Select.

1/2" Square Drive Sockets, SAE



6 Point and Double Hex, Thin Wall, Standard Length

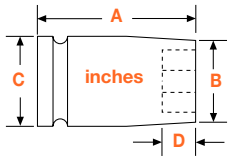

Part Number 6 Point	Part Number Double Hex	Hex Opening In.	Overall Length (A)	Diameter Nose End (B)	Diameter Drive End (C)	Opening Depth (D)
5410	-	5/16	1 1/2	19/32	15/16	1/4
5412	5412-D	3/8	1 1/2	19/32	15/16	1/4
5414	5414-D	7/16	1 1/2	21/32	15/16	9/32
5416	5416-D	1/2	1 1/2	23/32	15/16	11/32
5418	5418-D	9/16	1 1/2	13/16	15/16	7/16
5420	5420-D	5/8	1 1/2	7/8	15/16	7/16
5421	5421-D	21/32	1 1/2	29/32	15/16	7/16
HE-2422	HE-2422-D	11/16	1 1/2	1	1	7/16
*5422	*5422-D	11/16	1 1/2	15/16	15/16	7/16
OS-5424**	-	3/4	1 1/2	1 1/32	1 1/32	15/32
5424	5424-D	3/4	1 1/2	1 1/32	1 1/8	15/32
5425	5425-D	25/32	1 1/2	1 1/16	1 1/8	15/32
5426	5426-D	13/16	1 1/2	1 1/8	1 1/8	17/32
HE-1028	HE-1028-D	7/8	1 1/2	1 1/4	1 1/4	9/16
*5428	*5428-D	7/8	1 1/2	1 3/16	1 1/4	9/16
HE-530	HE-530-D	15/16	1 1/2	1 5/16	1 5/16	5/8
*5430	*5430-D	15/16	1 1/2	1 1/4	1 1/4	5/8
5432	5432-D	1	1 1/2	1 3/8	1 3/8	5/8
5434	5434-D	1 1/16	1 5/8	1 7/16	1 7/16	11/16
5436	5436-D	1 1/8	1 5/8	1 1/2	1 1/2	3/4
5438	5438-D	1 3/16	1 5/8	1 5/8	1 5/8	3/4
5440	5440-D	1 1/4	1 3/4	1 11/16	1 3/4	13/16
5442	5442-D	1 5/16	1 3/4	1 25/32	1 7/8	13/16

* Extra thin wall

** No ring groove

1/2" Square Drive Sockets, SAE



6 Point and Double Hex, Long and Extra Long Length

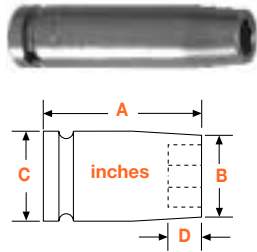

Part Number 6 Point	Part Number Double Hex	Hex Opening In.	Overall Length (A)	Diameter Nose End (B)	Diameter Drive End (C)	Opening Depth (D)
5210	-	5/16	2 1/4	1/2	15/16	3/16
5310	-	5/16	3 1/4	1/2	15/16	3/16
5212	5212-D	3/8	2 1/4	5/8	15/16	1/4
5312	5312-D	3/8	3 1/4	5/8	15/16	1/4
5214	5214-D	7/16	2 1/4	11/16	15/16	9/32
5314	5314-D	7/16	3 1/4	11/16	15/16	9/32
5216	5216-D	1/2	2 1/4	13/16	15/16	11/32
5316	5316-D	1/2	3 1/4	13/16	15/16	11/32
HE-9518	HE-9518-D	9/16	2 1/4	7/8	7/8	7/16
5218	5218-D	9/16	2 1/4	7/8	15/16	7/16
5318	5318-D	9/16	3 1/4	7/8	15/16	7/16
5220	5220-D	5/8	2 1/4	1	1	7/16
5320	5320-D	5/8	3 1/4	1	1	7/16
5222	5222-D	11/16	2 1/4	1 1/8	1 1/8	7/16
5322	5322-D	11/16	3 1/4	1 1/8	1 1/8	7/16
5224	5224-D	3/4	2 1/4	1 1/8	1 1/8	15/32
5324	5324-D	3/4	3 1/4	1 1/8	1 1/8	15/32
SW-493	SW-493-D	3/4	2 1/4	1 1/4	1 1/4	15/32
5226	5226-D	13/16	2 1/4	1 1/4	1 1/4	17/32
5326	5326-D	13/16	3 1/2	1 1/4	1 1/4	17/32
5228	5228-D	7/8	2 1/4	1 5/16	1 5/16	9/16
5328	5328-D	7/8	3 1/2	1 5/16	1 5/16	9/16
5230	5230-D	15/16	2 1/4	1 3/8	1 3/8	5/8
5330	5330-D	15/16	3 1/2	1 3/8	1 3/8	5/8
5232	5232-D	1	2 1/4	1 1/2	1 1/2	5/8
5332	5332-D	1	3 1/2	1 1/2	1 1/2	5/8
5234	5234-D	1 1/16	2 3/8	1 1/2	1 1/2	11/16
5334	5334-D	1 1/16	3 1/2	1 1/2	1 1/2	11/16
5236	5236-D	1 1/8	2 3/8	1 5/8	1 5/8	3/4
5336	5336-D	1 1/8	3 1/2	1 5/8	1 5/8	3/4
5238	5238-D	1 3/16	2 3/8	1 3/4	1 3/4	3/4
5338	5338-D	1 3/16	3 1/2	1 3/4	1 3/4	3/4
5240	5240-D	1 1/4	2 1/2	1 3/4	1 3/4	13/16
5340	5340-D	1 1/4	3 1/2	1 3/4	1 3/4	13/16
5242	-	1 5/16	2 1/2	1 7/8	1 7/8	13/16
5342	-	1 5/16	3 1/2	1 7/8	1 7/8	13/16
5244	-	1 3/8	2 1/2	2	2	13/16
5344	-	1 3/8	3 5/8	2	2	13/16
5246	-	1 7/16	2 1/2	2	2	15/16
5346	-	1 7/16	3 5/8	2	2	15/16
5248	-	1 1/2	2 1/2	2 1/8	2 1/8	1
5348	-	1 1/2	3 3/4	2 1/8	2 1/8	1

1/2" Square Drive Sockets, SAE



6 Point and Double Hex, Thin Wall, Extra Long Length

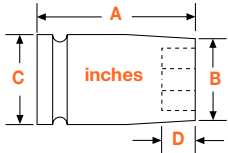

Part Number 6 Point	Part Number Double Hex	Hex Opening In.	Overall Length (A)	Diameter Nose End (B)	Diameter Drive End (C)	Opening Depth (D)
5510	-	5/16	3 1/4	1/2	15/16	3/16
5512	5512-D	3/8	3 1/4	19/32	15/16	1/4
5514	5514-D	7/16	3 1/4	21/32	15/16	9/32
5516	5516-D	1/2	3 1/4	23/32	15/16	11/32
OS-5516*	-	1/2	3 1/4	47/64	7/8	11/32
5518	5518-D	9/16	3 1/4	13/16	15/16	7/16
OS-5518*	-	9/16	3 1/4	13/16	27/32	7/16
5520	5520-D	5/8	3 1/4	7/8	15/16	7/16
5522	5522-D	11/16	3 1/4	15/16	15/16	7/16
5524	5524-D	3/4	3 1/4	1 1/32	1 1/8	15/32
5526	5526-D	13/16	3 1/2	1 1/8	1 1/8	17/32
5528	5528-D	7/8	3 1/2	1 3/16	1 1/4	9/16
5530	5530-D	15/16	3 1/2	1 1/4	1 1/4	5/8
5532	5532-D	1	3 1/2	1 3/8	1 3/8	5/8
5534	5534-D	1 1/16	3 1/2	1 7/16	1 7/16	11/16

Magnetic, Standard Length

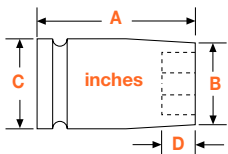

Part Number Fixed Magnet	Hex Opening In.	Overall Length (A)	Diameter Nose End (B)	Diameter Drive End (C)	Opening Depth (D)
M-5108	1/4	1 1/2	7/16	15/16	5/32
M-5110	5/16	1 1/2	1/2	15/16	3/16
M-5112	3/8	1 1/2	5/8	15/16	1/4
M-5114	7/16	1 1/2	11/16	15/16	9/32
M-5116	1/2	1 1/2	13/16	15/16	11/32
MSH-335	1/2	1 1/2	45/64	15/16	11/32
M-5118	9/16	1 1/2	7/8	15/16	7/16
MSH-336	9/16	1 1/2	27/32	15/16	7/16
M-5120	5/8	1 1/2	1	1	7/16
M-5122	11/16	1 1/2	1 1/8	1 1/8	7/16
M-5124	3/4	1 1/2	1 1/8	1 1/8	15/32
M-5126	13/16	1 1/2	1 1/4	1 1/4	17/32

Magnetic, Thin Wall, Standard Length

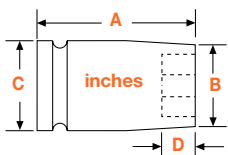

Part Number Fixed Magnet	Hex Opening In.	Overall Length (A)	Diameter Nose End (B)	Diameter Drive End (C)	Opening Depth (D)
M-5412	3/8	1 1/2	19/32	15/16	1/4
M-5414	7/16	1 1/2	21/32	15/16	9/32
M-5416	1/2	1 1/2	23/32	15/16	11/32
M-5418	9/16	1 1/2	13/16	15/16	7/16
M-5420	5/8	1 1/2	7/8	15/16	7/16

* No ring groove.

1/2" Square Drive Sockets, SAE



Magnetic, Long Length and Extra Long Length

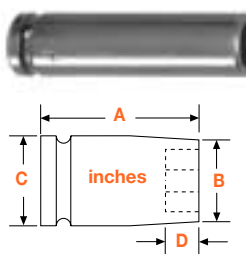

Part Number 6 Point	Part No. Magnetic Bolt Clearance	Hex Opening In.	Overall Length (A)	Diameter Nose End (B)	Diameter Drive End (C)	Opening Depth (D)
-	MB-5210	5/16	2 1/4	5/8	15/16	1/4
-	MB-5212	3/8	2 1/4	5/8	15/16	1/4
M-5512*	-	3/8	3 1/4	19/32	15/16	1/4
-	MB-5214	7/16	2 1/4	11/16	15/16	9/32
M-5216	MB-5216	1/2	2 1/4	13/16	15/16	11/32
M-5316	-	1/2	3 1/4	13/16	15/16	11/32
M-5218	-	9/16	2 1/4	7/8	15/16	7/16
-	MB-HE9518	9/16	2 1/4	7/8	15/16	7/16
M-5318	-	9/16	3 1/4	7/8	15/16	7/16
M-5518*	-	9/16	3 1/4	13/16	15/16	7/16
M-5220	MB-5220	5/8	2 1/4	1	1	7/16

*Thin Wall

Surface Drive and Fast Lead, Standard Length

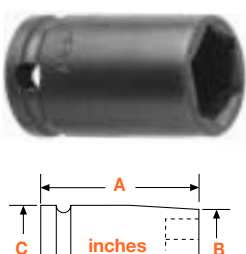

Part Number 6 Point	Part Number Fast Lead	Hex Opening In.	Overall Length (A)	Diameter Nose End (B)	Diameter Drive End (C)	Opening Depth (D)
SF-5112	FL-5112	3/8	1 1/2	5/8	15/16	1/4
SF-5114	FL-5114	7/16	1 1/2	11/16	15/16	9/32
SF-5116	FL-5116	1/2	1 1/2	13/16	15/16	11/32
SF-SH-335	FL-SH-335	1/2	1 1/2	45/64	15/16	11/32
SF-5118	FL-5118	9/16	1 1/2	7/8	15/16	7/16
SF-SH-336	FL-SH-336	9/16	1 1/2	27/32	15/16	7/16
SF-5120	FL-5120	5/8	1 1/2	1	1	7/16
-	FL-SH-338	5/8	1 1/2	15/16	1	7/16
SF-5122	FL-5122	11/16	1 1/2	1 1/8	1 1/8	7/16
SF-5124	FL-5124	3/4	1 1/2	1 1/8	1 1/8	15/32
SF-SW-282	FL-SW-282	3/4	1 1/2	1 1/4	1 1/4	15/32
SF-5126	FL-5126	13/16	1 1/2	1 1/4	1 1/4	17/32
SF-5128	FL-5128	7/8	1 1/2	1 5/16	1 5/16	9/16
SF-5130	FL-5130	15/16	1 1/2	1 3/8	1 3/8	5/8
SF-5132	FL-5132	1	1 1/2	1 1/2	1 1/2	5/8
SF-5134	FL-5134	1 1/16	1 5/8	1 1/2	1 1/2	11/16

Surface Drive and Fast Lead, Thin Wall, Standard Length



Part Number 6 Point	Part Number Fast Lead	Hex Opening In.	Overall Length (A)	Diameter Nose End (B)	Diameter Drive End (C)	Opening Depth (D)
SF-5412	-	3/8	1 1/2	19/32	15/16	1/4
SF-5414	FL-5414	7/16	1 1/2	21/32	15/16	9/32
SF-5416	FL-5416	1/2	1 1/2	23/32	15/16	11/32
SF-5418	FL-5418	9/16	1 1/2	13/16	15/16	7/16
SF-5420	-	5/8	1 1/2	7/8	15/16	7/16
SF-5422	-	11/16	1 1/2	15/16	15/16	7/16
SF-5424	-	3/4	1 1/2	1 1/32	1 1/8	15/32
SF-5426	-	13/16	1 1/2	1 1/8	1 1/8	17/32

1/2" Square Drive Sockets, SAE



Surface Drive and Fast Lead, Long and Extra Long Length

	Part Number 6 Point	Part Number Fast Lead	Hex Opening In.	Overall Length (A)	Diameter Nose End (B)	Diameter Drive End (C)	Opening Depth (D)
	SF-5212	-	3/8	2 1/4	9/16	15/16	9/32
	SF-5214	FL-5214	7/16	2 1/4	11/16	15/16	9/32
	SF-5216	FL-5216	1/2	2 1/4	13/16	15/16	11/32
	SF-5316	FL-5316	1/2	3 1/4	13/16	15/16	11/32
	SF-HE9518	FL- HE9518	9/16	2 1/4	7/8	7/8	7/16
	SF-5218	FL-5218	9/16	2 1/4	7/8	15/16	7/16
	SF-5318	FL-5318	9/16	3 1/4	7/8	15/16	7/16
	SF-5220	FL-5220	5/8	2 1/4	1	1	7/16
	SF-5320	FL-5320	5/8	3 1/4	1	1	7/16
	SF-5222	FL-5222	11/16	2 1/4	1 1/8	1 1/8	7/16
	SF-5322	FL-5322	11/16	3 1/4	1 1/8	1 1/8	7/16
	SF-5224	FL-5224	3/4	2 1/4	1 1/8	1 1/8	15/32
	-	FL-SW-493	3/4	2 1/4	1 1/4	1 1/4	15/32
	SF-5324	FL-5324	3/4	3 1/4	1 1/8	1 1/8	15/32
	SF-5226	FL-5226	13/16	2 1/4	1 1/4	1 1/4	17/32
	SF-5326	FL-5326	13/16	3 1/2	1 1/4	1 1/4	17/32
	SF-5228	FL-5228	7/8	2 1/4	1 5/16	1 5/16	9/16
	SF-5328	-	7/8	3 1/2	1 5/16	1 5/16	9/16
	SF-5230	-	15/16	2 1/4	1 3/8	1 3/8	5/8
	SF-5330	-	15/16	3 1/2	1 3/8	1 3/8	5/8
	SF-5232	-	1	2 1/4	1 1/2	1 1/2	5/8
	SF-5332	-	1	3 1/2	1 1/2	1 1/2	5/8
	SF-5334	-	1 1/16	3 1/2	1 1/2	1 1/2	11/16

Surface Drive, Thin Wall, Extra Long Length

	Part Number Surface Drive	Hex Opening In.	Overall Length (A)	Diameter Nose End (B)	Diameter Drive End (C)	Opening Depth (D)
	SF-5514	7/16	3 1/4	21/32	15/16	9/32
	SF-5516	1/2	3 1/4	23/32	15/16	11/32
	SF-5518	9/16	3 1/4	13/16	15/16	7/16
	SF-5520	5/8	3 1/4	7/8	15/16	7/16
	SF-5522	11/16	3 1/4	15/16	15/16	7/16
	SF-5524	3/4	3 1/4	1 1/32	1 1/8	15/32
	SF-5526	13/16	3 1/4	1 1/8	1 1/8	17/32
	SF-5528	7/8	3 1/2	1 3/16	1 1/4	9/16
	SF-5532	1	3 1/2	1 3/8	1 3/8	5/8
	SF-5534	1 1/16	3 1/2	1 7/16	1 7/16	11/16

1/2" Square Drive Sockets For SAE Sheet Metal Screws

6 Point and 6 Point Magnetic, for Predrilled Holes*

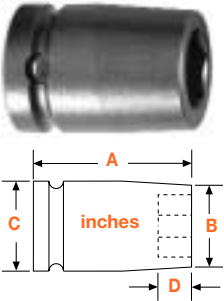

Part Number 6 Point	Part Number Magnetic	Hex Opening In.	Overall Length (A)	Diameter Nose End (B)	Diameter Drive End (C)	Opening Depth (D)
5E08	M5E08	1/4	1 1/2	7/16	15/16	5/32
5E10	M5E10	5/16	1 1/2	1/2	15/16	3/16
5E12	M5E12	3/8	1 1/2	5/8	15/16	1/4
5E14	M5E14	7/16	1 1/2	11/16	15/16	9/32
5E16	M5E16	1/2	1 1/2	13/16	15/16	11/32
5E18	M5E18	9/16	1 1/2	15/16	15/16	7/16

6 Point and 6 Point Magnetic, for Self-Tapping Screws*

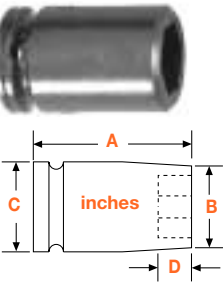

Part Number 6 Point	Part Number Magnetic	Hex Opening In.	Overall Length (A)	Diameter Nose End (B)	Diameter Drive End (C)	Opening Depth (D)
5P08	M5P08	1/4	1 1/2	7/16	15/16	5/32
5P10	M5P10	5/16	1 1/2	1/2	15/16	3/16
5P12	M5P12	3/8	1 1/2	5/8	15/16	1/4
5P14	M5P14	7/16	1 1/2	11/16	15/16	9/32
5P16	M5P16	1/2	1 1/2	13/16	15/16	11/32
5P18	M5P18	9/16	1 1/2	15/16	15/16	7/16

*Sockets for predrilled holes are intermediate hardness; sockets for self-tapping screws are maximum hardness.

1/2" Square Drive Sockets For SAE Square Nuts

Single Square and Double Square, Standard Length

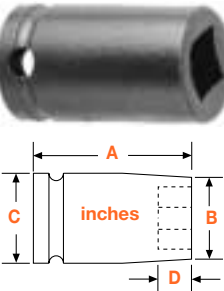

Part Number 6 Point	Part Number Double Square	Square Opening In.	Overall Length (A)	Diameter Nose End (B)	Diameter Drive End (C)	Opening Depth (D)
5608	5608-D	1/4	1 1/2	1/2	15/16	3/16
5609	5609-D	9/32	1 1/2	1/2	15/16	3/16
5610	5610-D	5/16	1 1/2	5/8	15/16	1/4
5612	5612-D	3/8	1 1/2	3/4	15/16	1/4
5614	5614-D	7/16	1 1/2	7/8	15/16	9/32
5616	5616-D	1/2	1 1/2	1	1	11/32
5618	5618-D	9/16	1 1/2	1 1/8	1 1/8	7/16
-	5619-D	19/32	1 1/2	1 1/8	1 1/8	7/16
5620	5620-D	5/8	1 1/2	1 1/4	1 1/4	7/16
5622	5622-D	11/16	1 1/2	1 1/4	1 1/4	7/16
5624	5624-D	3/4	1 1/2	1 3/8	1 3/8	15/32
5626	5626-D	13/16	1 1/2	1 1/2	1 1/2	17/32
5628	5628-D	7/8	1 1/2	1 5/8	1 5/8	5/8
5632	5632-D	1	1 5/8	1 3/4	1 3/4	5/8
5634	5634-D	1 1/16	1 3/4	1 7/8	1 7/8	11/16
5636	5636-D	1 1/8	1 3/4	2	2	3/4

Refer to Page iv for description of Rapid Select.

1/2" Square Drive Sockets For SAE Square Nuts



Single Square and Double Square, Thin Wall, Standard Length

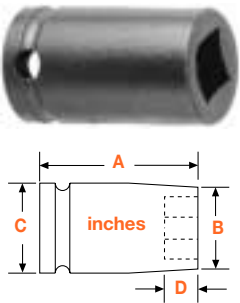

Part Number Square	Part Number Double Square	Square Opening In.	Overall Length (A)	Diameter Nose End (B)	Diameter Drive End (C)	Opening Depth (D)
5910	5910-D	5/16	1 1/2	19/32	15/16	1/4
5912	5912-D	3/8	1 1/2	11/16	15/16	1/4
5914	5914-D	7/16	1 1/2	25/32	15/16	9/32
5916	5916-D	1/2	1 1/2	15/16	15/16	11/32
5918	5918-D	9/16	1 1/2	1	1	7/16
5920	5920-D	5/8	1 1/2	1 3/32	1 1/8	7/16

Single Square and Double Square, Long and Extra Long Length

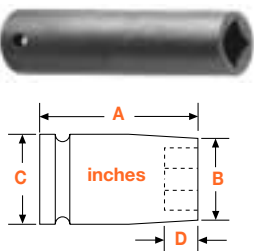

Part Number Square	Part Number Double Square	Square Opening In.	Overall Length (A)	Diameter Nose End (B)	Diameter Drive End (C)	Opening Depth (D)
5712	-	3/8	2 1/4	3/4	15/16	1/4
5812	5812-D	3/8	3 1/4	3/4	15/16	1/4
5714	-	7/16	2 1/4	7/8	15/16	9/32
-	5814-D	7/16	3 1/4	7/8	15/16	9/32
5716	5716-D	1/2	2 1/4	1	1	11/32
-	5816-D	1/2	3 1/4	1	1	7/16
5718	-	9/16	2 1/4	1 1/8	1 1/8	7/16
5818	5818-D	9/16	3 1/4	1 1/8	1 1/8	7/16
5720	-	5/8	2 1/4	1 1/4	1 1/4	7/16
5820	5820-D	5/8	3 1/2	1 1/4	1 1/4	7/16
5822	5822-D	11/16	3 1/2	1 1/4	1 1/4	7/16
5724	5724-D	3/4	2 1/4	1 3/8	1 3/8	15/32
-	5826-D	13/16	3 1/2	1 1/2	1 1/2	17/32
5728	-	7/8	2 1/4	1 5/8	1 5/8	5/8
-	5828-D	7/8	3 1/2	1 5/8	1 5/8	5/8
5732	-	1	2 1/4	1 3/4	1 3/4	5/8
-	5830-D	15/16	3 1/2	1 5/8	1 5/8	5/8
5832	5832-D	1	3 1/2	1 3/4	1 3/4	5/8
-	5834-D	1 1/16	3 1/2	1 7/8	1 7/8	11/16
5836	5836-D	1 1/8	3 1/2	2	2	3/4

1/2" Square Drive Socket Sets, SAE

6 Point



APS58	8 piece, standard length: 1/2, 9/16, 5/8, 11/16, 3/4, 13/16, 7/8, 15/16
APS510	10 piece, standard length: 7/16, 1/2, 9/16, 5/8, 11/16, 3/4, 13/16, 7/8, 15/16, 1
APS58XL	8 piece, extra long length: 1/2, 9/16, 5/8, 11/16, 3/4, 13/16, 7/8, 15/16

Universal Wrenches 1/2" Square Drive, SAE



6 Point and Double Hex

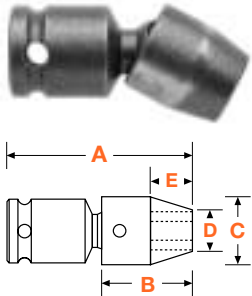

Part Number 6 Point	Part Number Double Hex	Hex Opening In.	Overall Length (A) In.	Socket Length (B) In.	Socket Diameter (C) In.	Nose End Diameter (D) In.	Clearance Depth (E) In.
SA-216	SA-216-D	3/8	2 11/64	7/8	7/8	9/16	11/32
SA-217	SA-217-D	7/16	2 15/64	15/16	7/8	5/8	13/32
SA-316	-	7/16	2 17/64	15/16	1	5/8	3/8
SA-218	SA-218-D	1/2	2 19/64	1	7/8	11/16	15/32
SA-317	-	1/2	2 31/64	1	1	11/16	7/16
SA-219	SA-219-D	9/16	2 23/64	1 1/16	7/8	3/4	17/32
SA-318	SA-318-D	9/16	2 29/64	1 1/8	1	3/4	9/16
SA-221	SA-221-D	5/8	2 27/64	1 1/8	7/8	7/8	19/32
SA-320	SA-320-D	5/8	2 33/64	1 3/16	1	27/32	5/8
SA-402	SA-402-D	5/8	2 49/64	1 1/4	1 1/4	7/8	33/64
SA-321	SA-321-D	11/16	2 37/64	1 1/4	1	1	11/16
SA-322	SA-322-D	3/4	2 37/64	1 1/4	1 1/8	1 1/8	11/16
SA-404	SA-404-D	3/4	2 57/64	1 3/8	1 1/4	1 1/32	5/8
SA-501	-	3/4	3 1/32	1 5/8	1 1/2	1 1/8	25/32
SA-406	-	13/16	2 57/64	1 3/8	1 1/4	1 1/8	41/64
SA-407	-	7/8	2 57/64	1 3/8	1 3/16	1 5/16	41/64
SA-409	SA-409-D	15/16	2 57/64	1 3/8	1 5/16	1 5/16	41/64
SA-505	-	15/16	3 5/32	1 3/4	1 1/2	1 3/8	29/32
SA-410	-	1	2 61/64	1 7/16	1 1/2	1 1/2	45/64
SA-411	-	1 1/16	3 1/64	1 1/2	1 1/2	1 1/2	49/64
SA-508	-	1 1/8	3 9/32	1 7/8	1 5/8	1 5/8	1 1/32
SA-510	-	1 1/4	3 13/32	2	1 3/4	1 3/4	1 5/32

Universal wrenches must not be used with impact drivers. Maximum operating angle is 30°.

1/2" Square Drive Universal Wrench Set, SAE

6 Point



APU56

6 piece, standard length: 7/16, 1/2, 9/16, 5/8, 11/16, 3/4

Universal Wrenches 1/2" Square Drive, SAE - Extension



6 Point, Standard and Tension Type

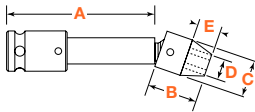



Universal wrenches must not be used with impact drivers. Maximum operating angle is 30°.

Part Number Standard	Part Number Tension	Hex Opening In.	Shank Length (A) In.	Socket Length (B) In.	Socket Diameter (C) In.	Nose End Diameter (D) In.	Opening Depth (E) In.
KH-43-3	-	3/8	3	13/16	5/8	17/32	7/16
KH-43-6	KN-43-6	3/8	6	13/16	5/8	17/32	7/16
KH-43-9	KN-43-9	3/8	9	13/16	5/8	17/32	7/16
KH-44-3	-	7/16	3	7/8	5/8	5/8	1/2
KH-44-4	KN-44-4	7/16	4	7/8	5/8	5/8	1/2
KH-44-6	KN-44-6	7/16	6	7/8	5/8	5/8	1/2
KH-44-9	-	7/16	9	7/8	5/8	5/8	1/2
-	KN-44-12	7/16	12	7/8	5/8	5/8	1/2
KH-45-3	-	1/2	3	7/8	11/16	11/16	1/2
KH-45-4	-	1/2	4	7/8	11/16	11/16	1/2
KH-45-6	KN-45-6	1/2	6	7/8	11/16	11/16	1/2
-	KN-45-9	1/2	9	7/8	11/16	11/16	1/2
KH-104-3	-	1/2	3	1	3/4	3/4	9/16
KH-104-4	-	1/2	4	1	3/4	3/4	9/16
KH-104-6	KN-104-6	1/2	6	1	3/4	3/4	9/16
KH-104-9	KN-104-9	1/2	9	1	3/4	3/4	9/16
KH-104-12	KN-104-12	1/2	12	1	3/4	3/4	9/16
KH-202-3	-	1/2	3	1	7/8	11/16	15/32
KH-202-6	KN-202-6	1/2	6	1	7/8	11/16	15/32
-	KN-202-8	1/2	9	1	7/8	11/16	15/32
KH-202-12	KN-202-12	1/2	12	1	7/8	11/16	15/32
KH-105-3	-	9/16	3	1	13/16	13/16	9/16
KH-105-4	-	9/16	4	1	13/16	13/16	9/16
KH-105-6	KN-105-6	9/16	6	1	13/16	13/16	9/16
-	KN-105-9	9/16	9	1	13/16	13/16	9/16
KH-105-12	KN-105-12	9/16	12	1	13/16	13/16	9/16
KH-203-3	-	9/16	3	1 1/16	7/8	3/4	17/32
KH-203-4	-	9/16	4	1 1/16	7/8	3/4	17/32
KH-203-6	KN-203-6	9/16	6	1 1/16	7/8	3/4	17/32
KH-203-9	KN-203-9	9/16	9	1 1/16	7/8	3/4	17/32
KH-203-12	KN-203-12	9/16	12	1 1/16	7/8	3/4	17/32
KH-318-3	KN-318-3	9/16	3	1 1/8	1	3/4	9/16
KH-318-4	KN-318-4	9/16	4	1 1/8	1	3/4	9/16
KH-318-6	KN-318-6	9/16	6	1 1/8	1	3/4	9/16
KH-318-9	-	9/16	9	1 1/8	1	3/4	9/16
KH-205-3	-	5/8	3	1 1/8	7/8	7/8	19/32
KH-205-4	-	5/8	4	1 1/8	7/8	7/8	19/32
KH-205-6	KN-205-6	5/8	6	1 1/8	7/8	7/8	19/32
KH-205-9	KN-205-9	5/8	9	1 1/8	7/8	7/8	19/32
KH-205-12	KN-205-12	5/8	12	1 1/8	7/8	7/8	19/32
KH-320-3	-	5/8	3	1 3/16	1	27/32	5/8

Universal Wrenches 1/2" Square Drive, SAE - Extension

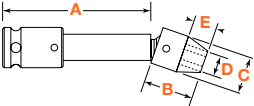

6 Point, Standard and Tension Type (continued)

	Part Number Standard	Part Number Tension	Hex Opening In.	Shank Length (A) In.	Socket Length (B) In.	Socket Diameter (C) In.	Nose End Diameter (D) In.	Clearance Depth (E) In.
	KH-320-6	KN-320-6	5/8	6	1 3/16	1	27/32	5/8
	KH-320-9	KN-320-9	5/8	9	1 3/16	1	27/32	5/8
	KH-320-12	KN-320-12	5/8	12	1 3/16	1	27/32	5/8
	KH-321-3	-	11/16	3	1 1/4	1	1	11/16
	KH-321-4	-	11/16	4	1 1/4	1	1	11/16
	KH-321-6	KN-321-6	11/16	6	1 1/4	1	1	11/16
	KH-321-9	KN-321-9	11/16	9	1 1/4	1	1	11/16
	KH-321-12	-	11/16	12	1 1/4	1	1	11/16
	KH-322-3	-	3/4	3	1 1/4	1 1/8	1 1/8	11/16
	KH-322-4	-	3/4	4	1 1/4	1 1/8	1 1/8	11/16
	KH-322-6	KN-322-6	3/4	6	1 1/4	1 1/8	1 1/8	11/16
	KH-322-9	KN-322-9	3/4	9	1 1/4	1 1/8	1 1/8	11/16
	KH-322-12	KN-322-12	3/4	12	1 1/4	1 1/8	1 1/8	11/16
	KH-404-3	-	3/4	3	1 3/8	1 1/4	1 1/32	41/64
	KH-404-4	-	3/4	4	1 3/8	1 1/4	1 1/32	41/64
	KH-404-6	KN-404-6	3/4	6	1 3/8	1 1/4	1 1/32	41/64
KH-404-9	KN-404-9	3/4	9	1 3/8	1 1/4	1 1/32	41/64	
KH-404-12	KN-404-12	3/4	12	1 3/8	1 1/4	1 1/32	41/64	
KH-409-3	-	15/16	3	1 3/8	1 5/16	1 5/16	41/64	
KH-409-4	-	15/16	4	1 3/8	1 5/16	1 5/16	41/64	
KH-409-6	-	15/16	6	1 3/8	1 5/16	1 5/16	41/64	
KH-409-9	-	15/16	9	1 3/8	1 5/16	1 5/16	41/64	
KH-409-12	-	15/16	12	1 3/8	1 5/16	1 5/16	41/64	

Universal wrenches must not be used with impact drivers. Maximum operating angle is 30°.

1/2" Square Drive Socket Head Bits, SAE

Complete, Adapter Only, Insert Only

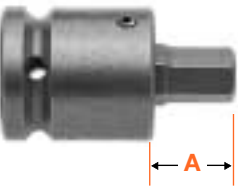
	Part Number			Hex Size	Overall Length		Length of Insert (A)	
	Complete	Adapter Only	Insert Only		In.	mm	In.	mm
	SZ-22	SC-514	SZ-14-A	1/4	2 1/2	64	1 3/8	35
	SZ-23	SC-514	SZ-15-A	5/16	2 1/2	64	1 3/8	35
	SZ-24	SC-514	SZ-16-A	3/8	2 1/2	64	1 3/8	35
	SZ-25	SC-514	SZ-17-A	1/2	2 1/2	64	1 3/8	35
	SZ-42	SC-520	SZ-31-A	1/2	2 1/2	64	1 9/16	35
	SZ-43	SC-514	SZ-18-A	9/16	2 1/2	64	1 3/8	35
	SZ-44	SC-529	SZ-32-A	9/16	2 1/2	64	1 9/16	35
	SZ-26	SC-514	SZ-19-A	5/8	2 1/2	64	1 3/8	35

For a complete listing, see page 36.
Adapters with an "SC" prefix feature a set screw for locking in the bit.
An "RP" prefix indicates adapters with a roll pin that is inserted through the bit.

1/2" Square Drive Sockets, Metric



6 Point and Double Hex, Standard Length

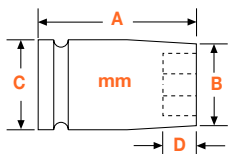

Part Number 6 Point	Part Number Double Hex	Hex Opening mm.	Overall Length (A)	Diameter Nose End (B)	Diameter Drive End (C)	Opening Depth (D)
10mm15	10mm15-D	10	38.1	16.7	23.8	6.4
11mm15	11mm15-D	11	38.1	17.5	23.8	7.2
12mm15	12mm15-D	12	38.1	19.1	23.8	7.2
13mm15	13mm15-D	13	38.1	22.2	23.8	8.7
14mm15	14mm15-D	14	38.1	22.2	23.8	11.1
15mm15	15mm15-D	15	38.1	23.8	23.8	11.1
16mm15	16mm15-D	16	38.1	25.4	25.4	11.1
17mm15	17mm15-D	17	38.1	28.6	28.6	11.1
18mm15	18mm15-D	18	38.1	28.6	28.6	11.1
19mm15	19mm15-D	19	38.1	28.6	28.6	11.9
20mm15	20mm15-D	20	38.1	31.7	31.7	11.9
21mm15	21mm15-D	21	38.1	31.7	31.7	13.5
22mm15	22mm15-D	22	38.1	33.3	33.3	14.3
23mm15	23mm15-D	23	38.1	34.9	34.9	15.9
24mm15	24mm15-D	24	38.1	34.9	34.9	15.9
25mm15	25mm15-D	25	38.1	38.1	38.1	15.9
26mm15	26mm15-D	26	38.1	38.1	38.1	15.9
27mm15	27mm15-D	27	41.3	41.3	41.3	17.5
28mm15	28mm15-D	28	41.3	41.3	41.3	19.1
29mm15	29mm15-D	29	41.3	44.4	44.4	19.1
30mm15	30mm15-D	30	41.3	44.4	44.4	19.1
32mm15	32mm15-D	32	44.4	44.4	44.4	20.6
33mm15	-	33	44.4	47.6	47.6	20.6
34mm15	-	34	47.6	47.5	47.5	20.5
35mm15	-	35	47.6	50.8	50.8	20.6
36mm15	-	36	47.6	50.8	50.8	23.8

6 Point and Double Hex, Thin Wall, Standard Length

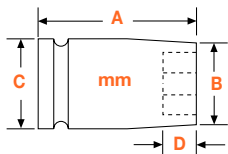

Part Number 6 Point	Part Number Double Hex	Hex Opening mm	Overall Length (A)	Diameter Nose End (B)	Diameter Drive End (C)	Opening Depth (D)
10mm45	10mm45-D	10	38.1	15.9	23.8	6.4
11mm45	11mm45-D	11	38.1	16.7	23.8	7.2
12mm45	12mm45-D	12	38.1	17.5	23.8	7.2
13mm45	13mm45-D	13	38.1	18.7	23.8	8.7
14mm45	14mm45-D	14	38.1	20.6	23.8	11.1
15mm45	15mm45-D	15	38.1	22.2	23.8	11.1
16mm45	16mm45-D	16	38.1	22.2	23.8	11.1
17mm45	17mm45-D	17	38.1	23.8	23.8	11.1
18mm45	18mm45-D	18	38.1	25.4	25.4	11.1
19mm45	19mm45-D	19	38.1	26.3	26.3	11.9
20mm45	-	20	38.1	27.0	28.6	11.9
21mm45	21mm45-D	21	38.1	28.6	28.6	13.5
22mm45	22mm45-D	22	38.1	30.2	31.7	14.3

1/2" Square Drive Sockets, Metric

6 Point and Double Hex, Long Length

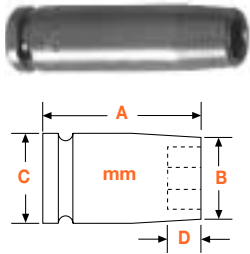

Part Number 6 Point	Part Number Double Hex	Hex Opening mm	Overall Length (A)	Diameter Nose End (B)	Diameter Drive End (C)	Opening Depth (D)
10mm25	10mm25-D	10	57.1	16.7	23.8	6.4
11mm25	11mm25-D	11	57.1	17.5	23.8	7.2
12mm25	12mm25-D	12	57.1	19.1	23.8	7.2
13mm25	13mm25-D	13	57.1	22.2	23.8	8.7
14mm25	-	14	57.1	22.2	23.8	11.1
15mm25	15mm25-D	15	57.1	23.8	23.8	11.1
16mm25	16mm25-D	16	57.1	25.4	25.4	11.1
17mm25	17mm25-D	17	57.1	28.6	28.6	11.1
18mm25	18mm25-D	18	57.1	28.6	28.6	11.1
19mm25	19mm25-D	19	57.1	28.6	28.6	11.9
20mm25	20mm25-D	20	57.1	31.7	31.7	11.9
21mm25	21mm25-D	21	57.1	31.7	31.7	13.5
22mm25	22mm25-D	22	57.1	33.3	33.3	14.3
23mm25	23mm25-D	23	57.1	34.9	34.9	15.9
24mm25	24mm25-D	24	57.1	34.9	34.9	15.9
25mm25	-	25	57.1	38.1	38.1	15.9
26mm25	-	26	57.1	38.1	38.1	15.9
27mm25	-	27	60.3	41.3	41.3	17.5
28mm25	-	28	60.3	41.3	41.3	19.1
29mm25	29mm25-D	29	60.3	44.4	44.4	19.1
30mm25	30mm25-D	30	60.3	44.4	44.4	19.1
32mm25	-	32	63.5	44.4	44.4	20.6

6 Point and Double Hex, Extra Long Length

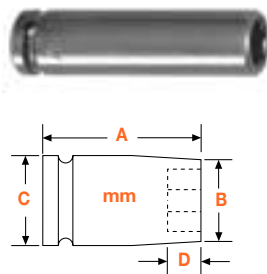

Part Number 6 Point	Part Number Double Hex	Hex Opening mm	Overall Length (A)	Diameter Nose End (B)	Diameter Drive End (C)	Opening Depth (D)
10mm35	10mm35-D	10	82.5	16.7	23.8	6.4
11mm35	11mm35-D	11	82.5	17.5	23.8	7.2
12mm35	12mm35-D	12	82.5	19.1	23.8	7.2
13mm35	13mm35-D	13	82.5	22.2	23.8	8.7
14mm35	14mm35-D	14	82.5	22.2	23.8	11.1
15mm35	15mm35-D	15	82.5	23.8	23.8	11.1
16mm35	16mm35-D	16	82.5	25.4	25.4	11.1
17mm35	17mm35-D	17	82.5	28.6	28.6	11.1
18mm35	18mm35-D	18	82.5	28.6	28.6	11.1
19mm35	19mm35-D	19	82.5	28.6	28.6	11.9
20mm35	20mm35-D	20	88.9	31.7	31.7	11.9
21mm35	21mm35-D	21	88.9	31.7	31.7	13.5
22mm35	22mm35-D	22	88.9	33.3	33.3	14.3
23mm35	-	23	88.9	34.9	34.9	15.9
24mm35	24mm35-D	24	88.9	34.9	34.9	15.9
25mm35	-	25	88.9	38.1	38.1	15.9

1/2" Square Drive Sockets, Metric



6 Point and Double Hex, Thin Wall, Extra Long Length

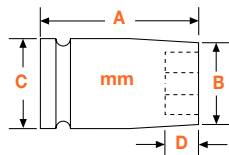

Part Number 6 Point	Part Number Double Hex	Hex Opening mm	Overall Length (A)	Diameter Nose End (B)	Diameter Drive End (C)	Opening Depth (D)
10mm55	10mm55-D	10	82.5	15.9	23.8	6.4
11mm55	-	11	82.5	16.7	23.8	7.2
12mm55	12mm55-D	12	82.5	17.5	23.8	7.2
13mm55	13mm55-D	13	82.5	18.7	23.8	8.7
14mm55	14mm55-D	14	82.5	20.6	23.8	11.1
15mm55	15mm55-D	15	82.5	22.2	23.8	11.1
16mm55	16mm55-D	16	82.5	22.2	23.8	11.1
17mm55	17mm55-D	17	82.5	23.8	23.8	11.1
18mm55	18mm55-D	18	82.5	25.4	25.4	11.1
19mm55	19mm55-D	19	82.5	26.3	26.3	11.9
20mm55	-	20	82.5	28.6	28.6	11.9
21mm55	21mm55-D	21	88.9	28.6	28.6	13.5
22mm55	22mm55-D	22	88.9	30.2	31.7	14.3
23mm55	-	23	88.9	31.7	31.7	15.9
24mm55	24mm55-D	24	88.9	33.3	33.3	15.9
26mm55	-	26	88.9	34.9	34.9	15.9
27mm55	27mm55-D	27	88.9	36.5	38.1	17.5
28mm55	-	28	88.9	36.5	38.1	19.1
29mm55	-	29	88.9	38.1	38.1	19.1
30mm55	-	30	88.9	39.7	41.1	19.1
32mm55	-	32	88.9	42.9	42.9	20.6

Magnetic, Standard Length

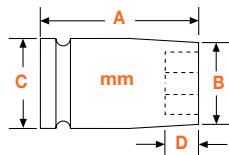

Part Number Fixed Magnet	Hex Opening mm	Overall Length (A)	Diameter Nose End (B)	Diameter Drive End (C)	Opening Depth (D)
M-10mm15	10	38.1	16.7	23.8	6.4
M-11mm15	11	38.1	17.5	23.8	7.2
M-12mm15	12	38.1	19.1	23.8	7.2
M-13mm15	13	38.1	22.2	23.8	8.7
M-14mm15	14	38.1	22.2	23.8	11.1
M-15mm15	15	38.1	23.8	23.8	11.1
M-16mm15	16	38.1	25.4	25.4	11.1
M-17mm15	17	38.1	28.6	28.6	11.1
M-18mm15	18	38.1	28.5	28.5	11.1
M-19mm15	19	38.1	28.6	28.6	11.9
M-21mm15	21	38.1	31.7	31.7	13.5

1/2" Square Drive Sockets, Metric

Magnetic, Thin Wall, Standard Length

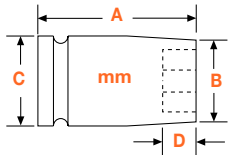

Part Number Fixed Magnet	Hex Opening mm	Overall Length (A)	Diameter Nose End (B)	Diameter Drive End (C)	Opening Depth (D)
M-10mm45	10	38.1	15.9	23.8	6.4
M-11mm45	11	38.1	16.7	23.8	7.2
M-12mm45	12	38.1	17.4	23.8	7.2
M-13mm45	13	38.1	18.7	23.8	8.7
M-14mm45	14	38.1	20.6	23.8	11.1
M-15mm45	15	38.1	22.2	23.8	11.1
M-16mm45	16	38.1	22.2	23.8	11.1

Magnetic, Long Length

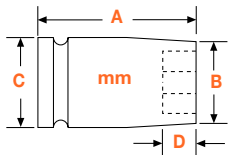

Part No. Fixed Magnet	Part No. Magnetic Bolt Clearance	Hex Opening mm	Overall Length (A)	Diameter Nose End (B)	Diameter Drive End (C)	Opening Depth (D)
-	MB-10mm25	10	57.1	16.7	23.8	6.4
-	MB-12mm25	12	57.1	19.1	23.8	7.2
M-13mm25	MB-13mm25	13	57.1	22.2	23.8	8.7
-	MB-14mm25	14	57.1	22.2	23.8	11.1
M-15mm25	MB-15mm25	15	57.1	23.8	23.8	11.1
-	MB-16mm25	16	57.1	25.4	25.4	11.1
M-18mm25	MB-18mm25	18	57.1	28.6	28.5	11.1

Magnetic, Extra Long Length

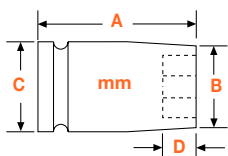

Part No. Fixed Magnet	Part No. Magnetic Bolt Clearance	Hex Opening mm	Overall Length (A)	Diameter Nose End (B)	Diameter Drive End (C)	Opening Depth (D)
M-12mm35	-	12	82.5	19.1	23.8	7.2
M-13mm35	-	13	82.5	22.2	23.8	8.7
M-13mm55*	-	13	82.5	18.7	23.8	8.7
M-15mm35	MB-15mm35	15	82.5	23.8	23.8	11.1
M-18mm35	MB-18mm35	18	82.5	28.6	28.6	11.1
M-18mm55*	-	18	82.5	25.4	25.4	11.1

*Thin Wall

1/2" Square Drive Sockets, Metric



Surface Drive, Standard Length

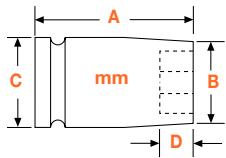

Part Number Surface Drive	Hex Opening mm	Overall Length (A)	Diameter Nose End (B)	Diameter Drive End (C)	Opening Depth (D)
SF-10mm15	10	38.1	16.7	23.8	6.4
SF-11mm15	11	38.1	17.5	23.8	7.2
SF-12mm15	12	38.1	19.1	23.8	7.2
SF-13mm15	13	38.1	22.2	23.8	8.7
SF-14mm15	14	38.1	22.2	23.8	11.1
SF-15mm15	15	38.1	23.8	23.8	11.1
SF-16mm15	16	38.1	25.4	25.4	11.1
SF-17mm15	17	38.1	28.6	28.6	11.1
SF-18mm15	18	38.1	28.6	28.6	11.1
SF-19mm15	19	38.1	28.6	28.6	11.9
SF-20mm15	20	38.1	31.7	31.7	11.9
SF-21mm15	21	38.1	31.7	31.7	13.5
SF-22mm15	22	38.1	33.3	33.3	14.3
SF-23mm15	23	38.1	34.9	34.9	15.9
SF-24mm15	24	38.1	34.9	34.9	15.9

Surface Drive, Thin Wall, Standard Length

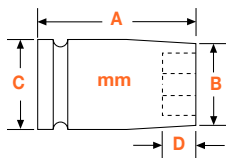

Part Number Surface Drive	Hex Opening mm	Overall Length (A)	Diameter Nose End (B)	Diameter Drive End (C)	Opening Depth (D)
SF-10mm45	10	38.1	15.9	23.8	6.4
SF-11mm45	11	38.1	16.7	23.8	7.2
SF-12mm45	12	38.1	17.5	23.8	7.2
SF-13mm45	13	38.1	18.7	23.8	8.7
SF-14mm45	14	38.1	20.6	23.8	11.1
SF-15mm45	15	38.1	22.2	23.8	11.1
SF-16mm45	16	38.1	22.2	23.8	11.1
SF-17mm45	17	38.1	23.8	23.8	11.1
SF-18mm45	18	38.1	25.4	25.4	11.1
SF-19mm45	19	38.1	26.3	26.3	11.9
SF-20mm45	20	38.1	27.0	28.6	11.9
SF-21mm45	21	38.1	28.6	28.6	11.9
SF-22mm45	22	38.1	30.2	31.7	11.9

1/2" Square Drive Sockets, Metric

Surface Drive, Long Length

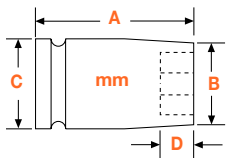

Part Number Surface Drive	Hex Opening mm	Overall Length (A)	Diameter Nose End (B)	Diameter Drive End (C)	Opening Depth (D)
SF-10mm25	10	57.1	16.7	23.8	6.4
SF-11mm25	11	57.1	17.5	23.8	7.2
SF-12mm25	12	57.1	19.1	23.8	7.2
SF-13mm25	13	57.1	22.2	23.8	7.2
SF-14mm25	14	57.1	22.2	23.8	11.1
SF-15mm25	15	57.1	23.8	23.8	11.1
SF-16mm25	16	57.1	25.4	25.4	11.1
SF-17mm25	17	57.1	28.6	28.6	11.1
SF-18mm25	18	57.1	28.6	28.6	11.1
SF-19mm25	19	57.1	28.6	28.6	11.9
SF-21mm25	21	57.1	31.7	31.7	13.5
SF-22mm25	22	57.1	33.3	33.3	14.3
SF-23mm25	23	57.1	34.9	34.9	15.9
SF-24mm25	24	57.1	34.9	34.9	15.9

Surface Drive, Extra Long Length

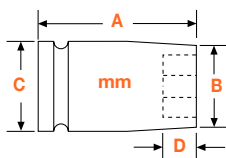

Part Number Surface Drive	Hex Opening mm	Overall Length (A)	Diameter Nose End (B)	Diameter Drive End (C)	Opening Depth (D)
SF-10mm35	10	82.5	16.7	23.8	6.4
SF-12mm35	12	82.5	17.5	23.8	7.2
SF-13mm35	13	82.5	19.1	23.8	7.2
SF-14mm35	14	82.5	22.2	23.8	11.1
SF-15mm35	15	82.5	23.8	23.8	11.1
SF-16mm35	16	82.5	25.4	25.4	11.1
SF-17mm35	17	82.5	28.6	28.6	11.1
SF-18mm35	18	82.5	28.6	28.6	11.1
SF-19mm35	19	82.5	28.6	28.6	11.9
SF-21mm35	21	88.9	31.7	31.7	13.5
SF-22mm35	22	88.9	33.3	33.3	14.3
SF-23mm35	23	88.9	34.9	34.9	15.9
SF-24mm35	24	88.9	34.9	34.9	15.9

1/2" Square Drive Sockets, Metric



Surface Drive, Thin Wall, Extra Long Length

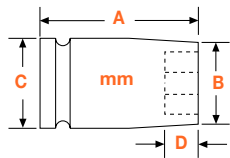

Part Number Surface Drive	Hex Opening mm	Overall Length (A)	Diameter Nose End (B)	Diameter Drive End (C)	Opening Depth (D)
SF-10mm55	10	82.5	15.9	23.8	6.4
SF-11mm55	11	82.5	16.7	23.8	7.2
SF-12mm55	12	82.5	17.5	23.8	7.2
SF-13mm55	13	82.5	18.7	23.8	8.7
SF-14mm55	14	82.5	20.6	23.8	11.1
SF-15mm55	15	82.5	22.2	23.8	11.1
SF-16mm55	16	82.5	22.2	23.8	11.1
SF-17mm55	17	82.5	23.8	23.8	11.1
SF-18mm55	18	82.5	25.4	25.4	11.1
SF-19mm55	19	82.5	26.3	26.3	11.9
SF-21mm55	21	88.9	28.6	28.6	13.5
SF-22mm55	22	88.9	30.2	31.7	15.9
SF-24mm55	24	88.9	33.3	33.3	15.9

1/2" Square Drive Sockets For Metric Sheet Metal Screws

6 Point and 6 Point Magnetic, For Regular Screws

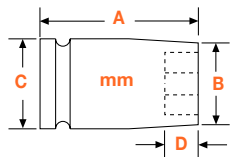

Part Number 6 Point	Part Number Magnetic	Hex Opening mm.	Overall Length (A)	Diameter Nose End (B)	Diameter Drive End (C)	Opening Depth (D)
13mmE5	M-13mmE5	13	38.1	22.2	23.8	8.7
15mmE5	M-15mmE5	15	38.1	23.8	23.8	11.1

1/2" Square Drive Socket Sets, Metric

6 Point

APS58M

8 piece, standard length: 13mm, 14mm, 15mm, 16mm, 17mm, 18mm, 19mm, 21mm



APS511M

11 piece, standard length: 10mm, 11mm, 12mm, 13mm, 14mm, 15mm, 16mm, 17mm, 18mm, 19mm, 21mm

APS58XLM

8 piece, extra long length: 13mm, 14mm, 15mm, 16mm, 17mm, 18mm, 19mm, 21mm

1/2" Square Drive Universal Wrenches, Metric

6 Point

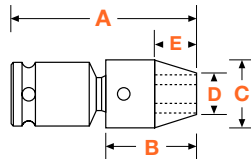

Part Number 6 Point	Hex Opening mm	Overall Length (A) mm	Socket Length (B) mm	Socket Diameter (C) mm	Nose End Diameter (D) mm	Clearance Depth (E) mm
SA-57-13m	13	58	25.4	22.2	17.5	11.9
SA-57-14m	14	60	27.0	22.2	19.1	13.5
SA-58-15m	15	62	28.6	25.4	19.8	14.3
SA-58-16m	16	64	30.2	25.4	21.4	15.9
SA-58-17m	17	66	31.8	25.4	25.4	17.5
SA-58-18m	18	66	31.8	25.4	25.4	17.5
SA-510-19m	19	73	34.9	31.8	26.2	16.3
SA-510-20m	20	73	34.9	31.8	27.0	16.3
SA-510-21m	21	73	34.9	31.8	28.6	16.3
SA-510-22m	22	73	34.9	31.8	31.8	16.3
SA-510-23m	23	73	34.9	31.8	33.3	16.3
SA-510-24m	24	73	34.9	31.8	34.9	16.3

1/2" Square Drive Universal Wrench Set, Metric

6 Point



APU56M 6 piece, standard length: 13mm, 14mm, 15mm, 16mm, 17mm, 18mm

1/2" Square Drive Universal Wrenches, Metric - Extension

6 Point, Standard and Tension Type

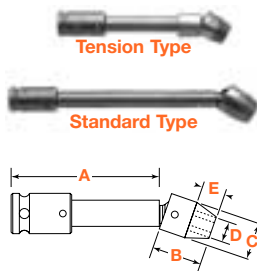







Part Number Standard	Part Number Tension	Hex Opening mm	Shank Length (A) mm	Socket Length (B) mm	Socket Diameter (C) mm	Nose End Diameter (D) mm	Clearance Depth (E) mm
KH-7-12m-3	-	12	76	23.8	22.2	17.5	10.3
KH-7-12m-4	-	12	102	23.8	22.2	17.5	10.3
KH-7-12m-6	KN-7-12m-6	12	152	23.8	22.2	17.5	10.3
KH-7-12m-9	KN-7-12m-9	12	229	23.8	22.2	17.5	10.3
KH-7-12m-12	-	12	305	23.8	22.2	17.5	10.3
KH-7-13m-3	-	13	76	25.4	22.2	17.5	11.9
KH-7-13m-4	-	13	102	25.4	22.2	17.5	11.9
KH-7-13m-6	KN-7-13m-6	13	152	25.4	22.2	17.5	11.9

Universal wrenches must not be used with impact drivers. Maximum operating angle is 30°.

1/2" Square Drive Universal Wrenches, Metric - Extension

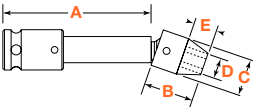





6 Point, Standard and Tension Type (continued)

	Part Number Standard	Part Number Tension	Hex Opening mm	Shank Length (A) mm	Socket Length (B) mm	Socket Diameter (C) mm	Nose End Diameter (D) mm	Clearance Depth (E) mm
	KH-7-13m-9	KN-7-13m-9	13	229	25.4	22.2	17.5	11.9
	KH-7-13m-12	KN-7-13m-12	13	305	25.4	22.2	17.5	11.9
	KH-7-14m-4	-	14	102	27.0	22.2	19.1	13.5
	KH-7-14m-6	KN-7-14m-6 	14	152	27.0	22.2	19.1	13.5
	-	KN-7-14m-9	14	229	27.0	22.2	19.1	13.5
	KH-7-14m-12	-	14	305	27.0	22.2	19.1	13.5
	KH-8-15m-3	-	15	76	28.6	25.4	19.8	14.3
	KH-8-15m-4	-	15	102	28.6	25.4	19.8	14.3
	KH-8-15m-6	KN-8-15m-6 	15	152	28.6	25.4	19.8	14.3
	KH-8-15m-9	KN-8-15m-9	15	229	28.6	25.4	19.8	14.3
	KH-8-15m-12	KN-8-15m-12	15	305	28.6	25.4	19.8	14.3
	KH-8-16m-3	-	16	76	30.2	25.4	21.4	15.9
	KH-8-16m-4	-	16	102	30.2	25.4	21.4	15.9
	KH-8-16m-6	KN-8-16m-6 	16	152	30.2	25.4	21.4	15.9
	KH-8-16m-9	KN-8-16m-9	16	229	30.2	25.4	21.4	15.9
	KH-8-16m-12	KN-8-16m-12	16	305	30.2	25.4	21.4	15.9
	KH-8-17m-3	-	17	76	31.8	25.4	25.4	17.5
	KH-8-17m-4	-	17	102	31.8	25.4	25.4	17.5
	KH-8-17m-6	KN-8-17m-6	17	152	31.8	25.4	25.4	17.5
	KH-8-17m-9	KN-8-17m-9	17	229	31.8	25.4	25.4	17.5
	KH-8-18m-3	-	18	76	31.8	25.4	25.4	17.5
	KH-8-18m-4	-	18	102	31.8	25.4	25.4	17.5
	KH-8-18m-6 	KN-8-18m-6	18	152	31.8	25.4	25.4	17.5
	KH-8-18m-9	KN-8-18m-9	18	229	31.8	25.4	25.4	17.5
	-	KN-8-18m-12	18	305	31.8	25.4	25.4	17.5
	KH-10-19m-3	-	19	76	34.9	31.8	26.2	16.3
	KH-10-19m-4	-	19	102	34.9	31.8	26.2	16.3
	KH-10-19m-6	-	19	152	34.9	31.8	26.2	16.3
	KH-10-19m-9	-	19	229	34.9	31.8	26.2	16.3
	KH-10-19m-12	-	19	305	34.9	31.8	26.2	16.3

Universal wrenches must not be used with impact drivers. Maximum operating angle is 30°.

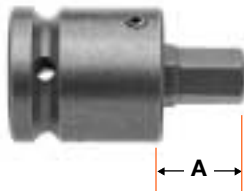
1/2" Square Drive Socket Head Bits, Metric

Complete, Adapter Only, Insert Only

	Part Number			Hex Size	Overall Length		Length of Insert (A)	
	Complete	Adapter Only	Insert Only		In.	mm	In.	mm
	SZ-5-7-8mm	SC-514 	SZ-7-8mm	8mm	2 1/2	64	1 3/8	35
	SZ-5-7-10mm	SC-514 	SZ-7-10mm	10mm	2 1/2	64	1 3/8	35
	SZ-5-7-12mm	SC-514 	SZ-7-12mm	12mm	2 1/2	64	1 3/8	35
	SZ-5-7-14mm	SC-514 	SZ-7-14mm	14mm	2 1/2	64	1 3/8	35
	SZ-5-10-14mm	RP-520	SZ-10-14mm	14mm	2 1/2	64	1 9/16	40
	SZ-5-10-17mm	RP-520	SZ-10-17mm	17mm	2 1/2	64	1 9/16	40

For a complete listing, see page 38.

 Refer to Page iv for description of Rapid Select.

1/2" Square Drive Sockets For Spline Fasteners

Standard and Long Length

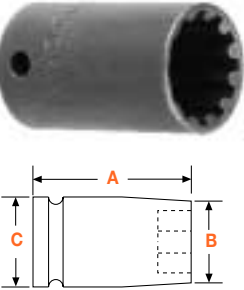

Part Number	Spline Size	Nominal Size	Overall Length (A)		Diameter Nose End (B)		Diameter Drive End (C)	
			In.	mm	In.	mm	In.	mm
CMS-5416	16	1/2	1 1/4	32	23/32	18	7/8	22
CMS-5420	20	5/8	1 1/2	38	7/8	22	7/8	22
CMS-5422	22	11/16	1 1/2	38	31/32	25	31/32	25
CMS-5424	24	3/4	1 1/2	38	1 1/32	26	1 1/32	26
CMS-5426	26	13/16	1 1/2	38	1 1/8	29	1 1/8	29
CMS-5526	26	13/16	3 1/4	83	1 1/8	29	1 1/8	29
CMS-5428	28	7/8	1 1/2	38	1 3/16	30	1 3/16	30
CMS-5430	30	15/16	1 1/2	38	1 1/4	32	1 1/4	32
CMS-5530	30	15/16	3 1/4	83	1 1/4	32	1 1/4	32

Apex spline sockets conform to military specifications MS-37787 and MIL-W-8982C.

1/2" Square Drive Torx® Sockets

For External Torx Screws

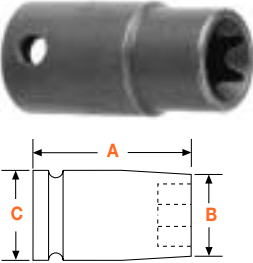

Part Number	Driver Size	Overall Length (A)		Diameter Nose End (B)		Diameter Drive End (C)	
		In.	mm	In.	mm	In.	mm
TX-5110	E-10	1 1/2	38	9/16	13	1	25
TX-5112	E-12	1 1/2	38	5/8	16	1	25
TX-5114	E-14	1 1/2	38	11/16	18	1	25
TX-5116	E-16	1 1/2	38	13/16	21	1	25
TX-5118	E-18	1 1/2	38	7/8	22	1	25
TX-5120	E-20	1 1/2	38	1	25	1 3/16	30
TX-5124	E-24	1 1/2	38	1 5/16	33	1 5/16	33

For External Torx Screws, Thin Wall

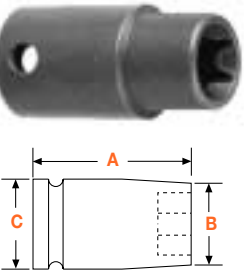

Part Number	Driver Size	Overall Length (A)		Diameter Nose End (B)		Diameter Drive End (C)	
		In.	mm	In.	mm	In.	mm
TX-5408	E-8	1 1/2	38	3/8	10	7/8	22
TX-5410	E-10	1 1/2	38	1/2	13	7/8	22
TX-5412	E-12	1 1/2	38	9/16	14	7/8	22
TX-5414	E-14	1 1/2	38	5/8	16	7/8	22
TX-5416	E-16	1 1/2	38	7/8	22	7/8	22
TX-5418	E-18	1 1/2	38	15/16	24	15/16	24
TX-5420	E-20	1 1/2	38	1 1/16	27	1 1/16	27

Refer to Page iv for description of Rapid Select.

1/2" Square Drive Extensions



1 23/32" to 18" (44mm to 457mm) Length



Part Number	Male Square In.	Type of Lock	Overall Length	
			In.	mm
EX-504	1/2	Pin	1 23/32	44
EX-504-B	1/2	Ball	1 23/32	44
EX-508-2	1/2	Pin	2	51
EX-508-B-2	1/2	Ball	2	51
EX-508-3	1/2	Pin	3	76
EX-508-B-3	1/2	Ball	3	76
EX-508-4	1/2	Pin	4	102
EX-508-B-4	1/2	Ball	4	102
EX-508-5	1/2	Pin	5	127
EX-508-B-5	1/2	Ball	5	127
EX-508-6	1/2	Pin	6	152
EX-508-B-6	1/2	Ball	6	152
EX-508-8	1/2	Pin	8	203
EX-508-B-8	1/2	Ball	8	203
EX-508-9	1/2	Pin	9	229
EX-508-B-9	1/2	Ball	9	229
EX-508-10	1/2	Pin	10	254
EX-508-B-10	1/2	Ball	10	254
EX-508-12	1/2	Pin	12	305
EX-508-B-12	1/2	Ball	12	305
EX-508-15	1/2	Pin	15	381
EX-508-B-15	1/2	Ball	15	381
EX-508-16	1/2	Pin	16	406
EX-508-18	1/2	Pin	18	457

1/2" Square Drive Adapters

1/4" to 3/8" Male Square



Part Number	Male Square In.	Female Square In.	Type of Lock	Overall Length	
				In.	mm
EX-260	1/4	1/2	Pin	1 1/2	38
EX-260-B	1/4	1/2	Ball	1 1/2	38
EX-258-2	1/4	1/2	Pin	2	51
EX-258-B-2	1/4	1/2	Ball	2	51
EX-258-4	1/4	1/2	Pin	4	102
EX-258-6	1/4	1/2	Pin	6	152
EX-375	3/8	1/2	Pin	1 1/2	38
EX-375-B	3/8	1/2	Ball	1 1/2	38
EX-377-2	3/8	1/2	Pin	2	51
EX-377-B-2	3/8	1/2	Ball	2	51
EX-377-3	3/8	1/2	Pin	3	76
EX-377-B-3	3/8	1/2	Ball	3	76
EX-377-4	3/8	1/2	Pin	4	102
EX-377-B-4	3/8	1/2	Ball	4	102

(Continued on next page.)

Refer to Page iv for description of Rapid Select.

1/2" Square Drive Adapters

3/8" to 3/4" Male Square (continued)



Part Number	Male Square In.	Female Square In.	Type of Lock	Overall Length	
				In.	mm
EX-377-5	3/8	1/2	Pin	5	127
EX-377-B-5	3/8	1/2	Ball	5	127
EX-377-6	3/8	1/2	Pin	6	152
EX-377-B-6	3/8	1/2	Ball	6	152
EX-377-8	3/8	1/2	Pin	8	203
EX-377-B-9	3/8	1/2	Ball	9	229
EX-377-10	3/8	1/2	Pin	10	254
EX-377-B-10	3/8	1/2	Ball	10	254
EX-377-12	3/8	1/2	Pin	12	305
EX-377-B-12	3/8	1/2	Ball	12	305
EX-377-15	3/8	1/2	Pin	15	381
EX-623	5/8	1/2	Pin	1 1/2	38
EX-623-B	5/8	1/2	Ball	1 1/2	38
EX-626-3	5/8	1/2	Pin	3	76
EX-626-4	5/8	1/2	Pin	4	102
EX-626-6	5/8	1/2	Pin	6	152
EX-751	3/4	1/2	7/32 Drill Hole	1 13/16	46
EX-751-B	3/4	1/2	Ball	1 13/16	46

1/2" Square Drive Universal Adapters

3/8" to 3/4" Male Square



Part Number	Male Square In.	Female Square In.	Type of Lock	Overall Length		Largest Diameter	
				In.	mm	in.	mm
MF-39	3/8	1/2	Pin	2 9/16	65	7/8	22
MF-39B	3/8	1/2	Ball	2 9/16	65	7/8	22
MF-50	1/2	1/2	Pin	2 11/16	68	1	25
MF-50B	1/2	1/2	Ball	2 11/16	68	1	25
MF-55	1/2	1/2	Pin	3 1/16	78	1 1/4	32
MF-55B	1/2	1/2	Ball	3 1/16	78	1 1/4	32
MF-70	3/4	1/2	7/32 Drill Hole	3 5/8	92	1 1/2	38
MF-70B	3/4	1/2	Ball	3 5/8	92	1 1/2	38

Universal wrenches must not be used with impact drivers. Maximum operating angle is 30°.

1/2" Square Drive Universal Adapters - Extension

1/2" Male Square



(Standard Type Shown)

Standard	Part Number		Male Sq. In.	Female Sq. In.	Type of Lock	Largest Diameter	
	Tension					In.	mm
KHM-37-6	KNM-37-6		3/8	1/2	Pin	3/4	19
KHM-38-6	KNM-38-6		3/8	1/2	Pin	7/8	22
KHM-50-6	KNM-50-6		1/2	1/2	Pin	1	25
KHM-50-B-6	KNM-50-B-6		1/2	1/2	Ball	1	25

Universal wrenches must not be used with impact drivers. Maximum operating angle is 30°. Standard lengths are 3", 6", 9" and 12" (76, 152, 229 and 305mm)

5/8" Square Drive Sockets, SAE



6 Point and Double Hex, Standard Length

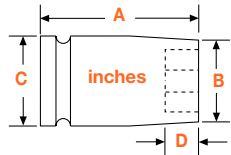

Part Number 6 Point	Part Number Double Hex	Hex Opening In.	Overall Length (A)	Diameter Nose End (B)	Diameter Drive End (C)	Opening Depth (D)
6116	6116-D	1/2	1 7/8	13/16	1 1/4	11/32
6118	6118-D	9/16	1 7/8	7/8	1 1/4	7/16
6120	6120-D	5/8	1 7/8	1	1 1/4	7/16
6122	6122-D	11/16	1 7/8	1 1/8	1 1/4	7/16
6124	6124-D	3/4	1 7/8	1 1/4	1 1/4	15/32
6126	-	13/16	1 7/8	1 1/4	1 1/4	17/32
6128	-	7/8	1 7/8	1 3/8	1 3/8	9/16
6130	6130-D	15/16	2	1 1/2	1 1/2	5/8
6132	-	1	2	1 5/8	1 5/8	5/8
6134	-	1 1/16	2	1 5/8	1 5/8	11/16
6136	-	1 1/8	2	1 5/8	1 5/8	3/4
6138	-	1 3/16	2	1 3/4	1 3/4	3/4
6140	-	1 1/4	2	1 7/8	1 7/8	13/16
6142	-	1 5/16	2	2	2	13/16
6144	-	1 3/8	2 1/8	2	2	13/16
6146	-	1 7/16	2 1/8	2 1/8	2 1/8	15/16
6148	-	1 1/2	2 1/4	2 1/8	2 1/8	1

6 Point and Double Hex, Thin Wall Standard Length

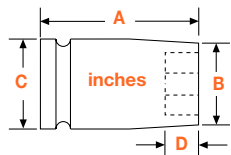

Part Number 6 Point	Part Number Double Hex	Hex Opening In.	Overall Length (A)	Diameter Nose End (B)	Diameter Drive End (C)	Opening Depth (D)
6414	6414-D	7/16	1 7/8	11/16	1 1/4	9/32
6418	-	9/16	1 7/8	7/8	1 1/4	7/16
6420	6420-D	5/8	1 7/8	15/16	1 1/4	7/16
6424	6424-D	3/4	1 7/8	1 1/16	1 1/4	15/32
6426	-	13/16	1 7/8	1 1/8	1 1/4	17/32
6428	6428-D	7/8	1 7/8	1 3/16	1 1/4	9/16
6430	6430-D	15/16	2	1 5/16	1 5/16	5/8
6432	-	1	2	1 3/8	1 3/8	5/8
6434	-	1 1/16	2	1 1/2	1 1/2	11/16
6436	-	1 1/8	2	1 1/2	1 1/2	3/4
6440	-	1 1/4	2	1 3/4	1 3/4	13/16
6444	-	1 3/8	2 1/8	1 7/8	1 7/8	13/16

5/8" Square Drive Sockets, SAE

6 Point and Double Hex, Extra Long Length

Part Number 6 Point	Part Number Double Hex	Hex Opening In.	Overall Length (A)	Diameter Nose End (B)	Diameter Drive End (C)	Opening Depth (D)
6320	-	5/8	3 1/2	1	1 1/4	7/16
6322	6322-D	11/16	3 1/2	1 1/8	1 1/4	7/16
6324	6324-D	3/4	3 1/2	1 1/4	1 1/4	15/32
6326	6326-D	13/16	3 1/2	1 1/4	1 1/4	17/32
6328	-	7/8	3 1/2	1 3/8	1 3/8	9/16
6330	6330-D	15/16	3 1/2	1 1/2	1 1/2	5/8
6332	6332-D	1	3 1/2	1 5/8	1 5/8	5/8
6334	6334-D	1 1/16	3 1/2	1 5/8	1 5/8	11/16
6336	6336-D	1 1/8	3 1/2	1 5/8	1 5/8	3/4
6338	-	1 3/16	3 1/2	1 3/4	1 3/4	3/4
6340	6340-D	1 1/4	3 1/2	1 7/8	1 7/8	13/16
6342	-	1 5/16	3 1/2	2	2	13/16
6344	6344-D	1 3/8	3 1/2	2	2	13/16
6346	6346-D	1 7/16	3 1/2	2 1/8	2 1/8	15/16
6348	-	1 1/2	3 1/2	2 1/8	2 1/8	1
6352	6352-D	1 5/8	3 3/4	2 1/4	2 1/4	1 1/8

6 Point and Double Hex, Thin Wall, Extra Long Length

Part Number 6 Point	Part Number Double Hex	Hex Opening In.	Overall Length (A)	Diameter Nose End (B)	Diameter Drive End (C)	Opening Depth (D)
6520	6520-D	5/8	3 1/2	15/16	1 1/4	7/16
6522	6522-D	11/16	3 1/2	1	1 1/4	7/16
6524	6524-D	3/4	3 1/2	1 1/16	1 1/4	15/32
6526	-	13/16	3 1/2	1 1/8	1 1/4	17/32
6528	6528-D	7/8	3 1/2	1 3/16	1 1/4	9/16
6530	6530-D	15/16	3 1/2	1 5/16	1 5/16	5/8

Surface Drive and Fast Lead, Standard Length

Part No. Surface Drive	Part Number Fast Lead	Hex Opening In.	Overall Length (A)	Diameter Nose End (B)	Diameter Drive End (C)	Opening Depth (D)
SF-6118	-	9/16	1 7/8	7/8	1 1/4	7/16
SF-6418*	-	9/16	1 7/8	7/8	1 1/4	7/16
SF-6120	FL-6120	5/8	1 7/8	1	1 1/4	7/16
SF-6122	-	11/16	1 7/8	1 1/8	1 1/4	7/16
SF-6124	FL-6124	3/4	1 7/8	1 1/4	1 1/4	15/32
SF-6424*	-	3/4	1 7/8	1 1/16	1 1/4	15/32
SF-6126	-	13/16	1 7/8	1 1/4	1 1/4	17/32
SF-6128	FL-6128	7/8	1 7/8	1 3/8	1 3/8	9/16
SF-6130	-	15/16	2	1 1/2	1 1/2	5/8
-	FL-6132	1	2	1 5/8	1 5/8	5/8

*Thin Wall

5/8" Square Drive Sockets, SAE



Surface Drive and Fast Lead, Extra Long Length

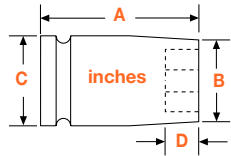

Part No. Surface Drive	Part Number Fast Lead	Hex Opening In.	Overall Length (A)	Diameter Nose End (B)	Diameter Drive End (C)	Opening Depth (D)
SF-6320	FL-6320	5/8	3 1/2	1	1 1/4	7/16
SF-6520*	-	5/8	3 1/2	15/16	1 1/4	7/16
SF-6522*	-	11/16	3 1/2	1	1 1/4	7/16
SF-6324	FL-6324	3/4	3 1/2	1 1/4	1 1/4	15/32
SF-6524*	-	3/4	3 1/2	1 1/16	1 1/4	15/32
SF-6326	FL-6326	13/16	3 1/2	1 1/4	1 1/4	17/32
SF-6526*	-	13/16	3 1/2	1 1/8	1 1/4	17/32
SF-6328	FL-6328	7/8	3 1/2	1 3/8	1 3/8	9/16
SF-6330	FL-6330	15/16	3 1/2	1 1/2	1 1/2	5/8

*Thin Wall

5/8" Square Drive Universal Wrenches, SAE

6 Point

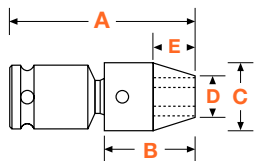

Part Number 6 Point	Hex Opening In.	Overall Length (A) In.	Socket Length (B) In.	Socket Diameter (C) In.	Nose End Diameter (D) In.	Clearance Depth (E) In.
SA-430	9/16	2 59/64	1 1/4	1 1/4	2 5/32	33/64
SA-432	5/8	2 59/64	1 1/4	1 1/4	7/8	33/64
SA-434	3/4	3 3/64	1 3/8	1 1/4	1 1/32	41/64
SA-436	13/16	3 3/64	1 3/8	1 1/4	1 1/8	41/64
SA-563	7/8	3 1/8	1 3/4	1 1/2	1 5/16	29/32
SA-439	15/16	3 3/64	1 3/8	1 5/16	1 5/16	41/64
SA-565	15/16	3 1/8	1 3/4	1 1/2	1 3/8	29/32
SA-568	1 1/8	3 1/4	1 7/8	1 5/8	1 5/8	1 1/32

Universal wrenches must not be used with impact drivers. Maximum operating angle is 30°.

Budd Wheel Socket

Combo. 13/16" Square 1 1/2" Hex



Part Number	Drive	Overall Length In.	Overall Length mm
BW-648	5/8" Square	3	76

5/8" Square Drive Sockets, Metric



6 Point and Surface Drive, Standard Length

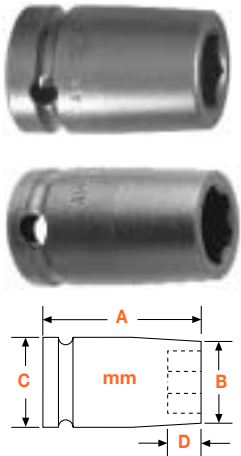

Part Number 6 Point	Part No. Surface Drive	Hex Opening mm	Overall Length (A)	Diameter Nose End (B)	Diameter Drive End (C)	Opening Depth (D)
15mm16	SF-15mm16	15	48	23.8	31.8	11.1
16mm16	SF-16mm16	16	48	25.4	31.8	11.1
17mm16	SF-17mm16	17	48	28.6	31.8	11.1
18mm16	SF-18mm16	18	48	28.5	31.8	11.1
19mm16	SF-19mm16	19	48	31.8	31.8	11.9
20mm16	-	20	48	31.8	31.8	11.9
21mm16	SF-21mm16	21	48	31.8	31.8	13.5
22mm16	SF-22mm16	22	48	34.9	34.9	14.3
23mm16	-	23	48	34.9	34.9	15.9
24mm16	SF-24mm16	24	51	38.1	38.1	15.9

6 Point and Surface Drive, Extra Long Length



Part Number 6 Point	Part No. Surface Drive	Hex Opening mm	Overall Length (A)	Diameter Nose End (B)	Diameter Drive End (C)	Opening Depth (D)
15mm36	SF-15mm36	15	89	23.8	31.8	11.1
17mm36	-	17	89	25.4	31.8	11.1
18mm36	SF-18mm36	18	89	28.6	31.8	11.1
19mm36	SF-19mm36	19	89	31.8	31.8	11.9
21mm36	SF-21mm36	21	89	31.8	31.8	13.5
22mm36	SF-22mm36	22	89	34.9	34.9	14.3
23mm36	-	23	89	34.9	34.9	15.9
24mm36	SF-24mm36	24	89	38.1	38.1	15.9

5/8" Square Drive Extensions

1 7/8" to 15" (48mm to 381mm) Length



Part Number	Male Square In.	Type of Lock	Overall Length	
			In.	mm
EX-624	5/8	Pin	1 7/8	48
EX-624-B	5/8	Ball	1 7/8	48
EX-627-3	5/8	Pin	3	76
EX-627-4	5/8	Pin	4	102
EX-627-6	5/8	Pin	6	152
EX-627-8	5/8	Pin	8	203
EX-627-10	5/8	Pin	10	254
EX-627-12	5/8	Pin	12	305
EX-627-15	5/8	Pin	15	381

5/8" Square Drive Adapters



1/2" to 3/4" Male Square



Part Number	Male Square In.	Female Square In.	Type of Lock	Overall Length	
				In.	mm
EX-505	1/2	5/8	Pin	1 7/8	48
EX-505-B	1/2	5/8	Ball	1 7/8	48
EX-509-3	1/2	5/8	Pin	3	76
EX-509-4	1/2	5/8	Pin	4	102
EX-509-5	1/2	5/8	Pin	5	127
EX-509-6	1/2	5/8	Pin	6	152
EX-509-10	1/2	5/8	Pin	10	254
EX-509-12	1/2	5/8	Pin	12	305
EX-752	3/4	5/8	7/32 Drill Hole	1 7/8	48
EX-752-B	3/4	5/8	Ball	1 7/8	48

5/8" Square Drive Universal Adapters

1/2" to 5/8" Male Square



Part Number	Male Square In.	Female Square In.	Type of Lock	Overall Length		Largest Diameter	
				In.	mm	in.	mm
MF-51	1/2	5/8	Pin	3 5/16	84	1 1/4	32
MF-51B	1/2	5/8	Ball	3 5/16	84	1 1/4	32
MF-62	5/8	5/8	Pin	3 1/4	83	1 1/4	32
MF-62B	5/8	5/8	Ball	3 1/4	83	1 1/4	32

Universal wrenches must not be used with impact drivers. Maximum operating angle is 30°.

3/4" Square Drive Sockets, SAE



6 Point and Double Hex, Standard Length

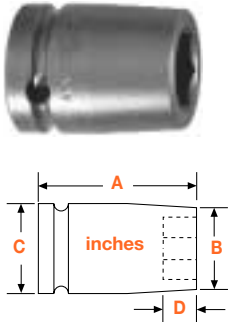

Part Number 6 Point	Part Number Double Hex	Hex Opening In.	Overall Length (A)	Diameter Nose End (B)	Diameter Drive End (C)	Opening Depth (D)
7116	-	1/2	2	13/16	1 1/2	11/32
7118	-	9/16	2	7/8	1 1/2	7/16
7120	7120-D	5/8	2	1 1/16	1 1/2	7/16
7122	7122-D	11/16	2	1 1/8	1 1/2	7/16
7124	7124-D	3/4	2	1 1/4	1 1/2	15/32
7126	7126-D	13/16	2	1 3/8	1 1/2	17/32
7128	7128-D	7/8	2	1 1/2	1 1/2	9/16
7130	7130-D	15/16	2	1 1/2	1 1/2	5/8
7132	7132-D	1	2	1 5/8	1 5/8	5/8
7134	7134-D	1 1/16	2	1 3/4	1 3/4	11/16
7136	7136-D	1 1/8	2 1/8	1 3/4	1 3/4	3/4
7138	7138-D	1 3/16	2 1/8	1 7/8	1 3/4	3/4
7140	7140-D	1 1/4	2 1/8	2	1 3/4	13/16
7142	7142-D	1 5/16	2 1/8	2	1 3/4	13/16
7144	7144-D	1 3/8	2 1/8	2 1/8	2 1/8	13/16
7146	-	1 7/16	2 1/4	2 1/4	2 1/8	15/16
7148	7148-D	1 1/2	2 1/4	2 1/4	2 1/8	1
7150	7150-D	1 9/16	2 1/4	2 3/8	2 1/8	1
7152	7152-D	1 5/8	2 1/4	2 1/2	2 1/8	1 1/8
7154	7154-D	1 11/16	2 1/4	2 1/2	2 1/8	1 1/8
7156	7156-D	1 3/4	2 1/4	2 5/8	2 1/8	1 1/8
7158	7158-D	1 13/16	2 1/4	2 3/4	2 1/8	1 1/4
7160	7160-D	1 7/8	2 1/4	2 3/4	2 1/8	1 1/4
7162	-	1 15/16	2 1/4	2 7/8	2 1/8	1 1/4
7164	7164-D	2	2 3/8	2 7/8	2 1/8	1 3/8
7166	7166-D	2 1/16	2 3/8	3	2 1/8	1 3/8
7168	7168-D	2 1/8	2 3/8	3 1/8	2 1/8	1 3/8
7170	7170-D	2 3/16	2 1/2	3 1/8	2 1/8	1 1/2
7172	7172-D	2 1/4	2 1/2	3 1/4	2 1/8	1 1/2
7174	-	2 5/16	2 1/2	3 3/8	2 1/8	1 1/2
7176	7176-D	2 3/8	2 5/8	3 1/2	2 1/8	1 5/8
7178	-	2 7/16	2 5/8	3 1/2	2 1/8	1 5/8
7180	7180-D	2 1/2	2 5/8	3 1/2	2 1/8	1 5/8

3/4" Square Drive Sockets, SAE



6 Point and Double Hex, Thin Wall, Standard Length

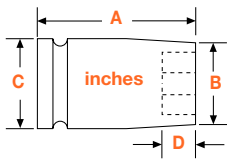

Part Number 6 Point	Part Number Double Hex	Hex Opening In.	Overall Length (A)	Diameter Nose End (B)	Diameter Drive End (C)	Opening Depth (D)
7424	7424-D	3/4	2	1 1/8	1 3/8	15/32
7426	-	13/16	2	1 1/4	1 3/8	17/32
7428	7428-D	7/8	2	1 5/16	1 3/8	9/16
7430	7430-D	15/16	2	1 3/8	1 3/8	5/8
7432	7432-D	1	2	1 7/16	1 7/16	5/8
7434	7434-D	1 1/16	2	1 1/2	1 1/2	11/16
7436	7436-D	1 1/8	2 1/8	1 5/8	1 5/8	3/4
7438	7438-D	1 3/16	2 1/8	1 5/8	1 5/8	3/4
7440	7440-D	1 1/4	2 1/8	1 3/4	1 3/4	13/16
7442	7442-D	1 5/16	2 1/8	1 7/8	1 3/4	13/16
7444	-	1 3/8	2 1/8	2	1 3/4	13/16
7446	-	1 7/16	2 1/4	2	1 3/4	15/16
7448	7448-D	1 1/2	2 1/4	2 1/8	2 1/8	1
7450	-	1 9/16	2 1/4	2 3/16	2 1/8	1 1/8
7452	-	1 5/8	2 1/4	2 1/4	2 1/8	1 1/8
7454	-	1 11/16	2 1/4	2 3/8	2 1/8	1 1/8
7456	-	1 3/4	2 1/4	2 7/16	2 1/8	1 1/8
7458	-	1 13/16	2 1/4	2 1/2	2 1/8	1 1/4
7460	-	1 7/8	2 1/4	2 5/8	2 1/8	1 1/4
7464	-	2	2 3/8	2 3/4	2 1/8	1 3/8
7466	-	2 1/16	2 3/8	2 13/16	2 5/8	1 3/8
7470	-	2 3/16	2 3/8	3	2 5/8	1 3/8
7472	-	2 1/4	2 3/8	3	2 5/8	1 3/8

3/4" Square Drive Sockets, SAE

6 Point and Double Hex, Extra Long Length

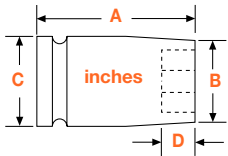

Part Number 6 Point	Part Number Double Hex	Hex Opening In.	Overall Length (A)	Diameter Nose End (B)	Diameter Drive End (C)	Opening Depth (D)
7320	-	5/8	4	1 1/16	1 1/2	7/16
7322	7322-D	11/16	4	1 1/8	1 1/2	7/16
7324SKT	7324-D	3/4	4	1 1/4	1 1/2	15/32
7326	-	13/16	4	1 3/8	1 1/2	17/32
7328	7328-D	7/8	4	1 7/16	1 1/2	9/16
7330	7330-D	15/16	4	1 1/2	1 1/2	5/8
7332	7332-D	1	4	1 1/2	1 1/2	5/8
7334	7334-D	1 1/16	4	1 5/8	1 5/8	11/16
7336	7336-D	1 1/8	4	1 3/4	1 3/4	3/4
7338	7338-D	1 3/16	4	1 3/4	1 3/4	3/4
7340	-	1 1/4	4	1 7/8	1 3/4	13/16
7342	-	1 5/16	4	2	1 3/4	13/16
7344	-	1 3/8	4	2 1/8	2 1/8	13/16
7346	-	1 7/16	4	2 1/8	2 1/8	15/16
7348	-	1 1/2	4	2 1/4	2 1/8	1
7350	-	1 9/16	4	2 3/8	2 1/8	1
7352	-	1 5/8	4	2 1/2	2 1/8	1 1/8
7354	-	1 11/16	4	2 1/2	2 1/8	1 1/8
7356	-	1 3/4	4	2 5/8	2 1/8	1 1/8
7358	-	1 13/16	4	2 3/4	2 1/8	1 1/4
7360	-	1 7/8	4	2 3/4	2 1/8	1 1/4
7362	-	1 15/16	4	2 3/4	2 1/8	1 1/4
7364	-	2	4 1/8	2 7/8	2 1/8	1 3/8
7372	-	2 1/4	4 1/4	3 1/4	2 1/8	1 1/2
7376	-	2 3/8	4 1/4	3 3/8	2 1/8	1 5/8

6 Point and Double Hex, Thin Wall, Extra Long Length

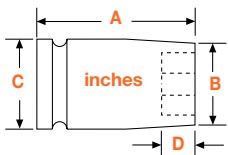

Part Number 6 Point	Part Number Double Hex	Hex Opening In.	Overall Length (A)	Diameter Nose End (B)	Diameter Drive End (C)	Opening Depth (D)
7524	-	3/4	4	1 1/8	1 3/8	15/32
7526	-	13/16	4	1 1/4	1 3/8	17/32
7528	-	7/8	4	1 3/8	1 3/8	9/16
7530	7530-D	15/16	4	1 3/8	1 3/8	5/8
7532	7532-D	1	4	1 7/16	1 7/16	5/8
7534	7534-D	1 1/16	4	1 1/2	1 1/2	11/16
7536	7536-D	1 1/8	4	1 5/8	1 5/8	3/4
7538	-	1 3/16	4	1 11/16	1 11/16	3/4
7540	-	1 1/4	4	1 3/4	1 3/4	13/16
7542	-	1 5/16	4	1 7/8	1 3/4	13/16
7544	-	1 3/8	4	2	1 3/4	13/16
7546	-	1 7/16	4	2	1 3/4	15/16
7548	-	1 1/2	4	2 1/8	2 1/8	1
7552	-	1 5/8	4	2 1/4	2 1/8	1 1/8
7556	-	1 3/4	4	2 1/2	2 1/8	1 1/8
7564	-	2	4 1/8	2 3/4	2 1/8	1 3/8

3/4" Square Drive Sockets For SAE Square Nuts



Single Square and Double Square, Standard Length

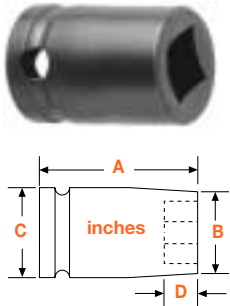

Part No. Single Square	Part No. Double Square	Square Opening In.	Overall Length (A)	Diameter Nose End (B)	Diameter Drive End (C)	Opening Depth (D)
7620	-	5/8	2	1 1/4	1 1/2	7/16
7622	-	11/16	2	1 3/8	1 1/2	7/16
7624	7624-D	3/4	2	1 1/2	1 1/2	15/32
7626	7626-D	13/16	2	1 5/8	1 5/8	17/32
7628	7628-D	7/8	2	1 3/4	1 3/4	5/8
7630	7630-D	15/16	2 1/8	1 7/8	1 3/4	5/8
7632	7632-D	1	2 1/8	2	1 3/4	5/8
-	7634-D	1 1/16	2 1/8	2	1 3/4	11/16
7636	7636-D	1 1/8	2 1/8	2 1/8	2 1/8	3/4
-	7638-D	1 3/16	2 1/8	2 1/4	2 1/8	5/8
-	7640-D	1 1/4	2 1/8	2 1/4	2 1/8	5/8
-	7642-D	1 5/16	2 1/8	2 1/2	2 1/8	5/8

3/4" Square Drive Universal Wrenches, SAE 6 Point

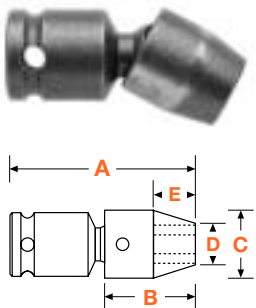

Part Number 6 Point	Hex Opening In.	Overall Length (A) In.	Socket Length (B) In.	Socket Diameter (C) In.	Nose End Diameter (D) In.	Clearance Depth (E) In.
SA-535	15/16	3 25/32	1 3/4	1 1/2	1 3/8	29/32
SA-601	15/16	4 1/32	1 15/16	1 3/4	1 1/2	29/32
SA-537	1 1/16	3 29/32	1 7/8	1 5/8	1 5/8	1 1/32
SA-603	1 1/16	4 3/32	2	1 3/4	1 5/8	31/32
SA-743	1 1/16	3 31/32	2	2	1 11/16	1 3/16
SA-538	1 1/8	3 29/32	1 7/8	1 5/8	1 5/8	1 1/32
SA-604	1 1/8	4 5/32	2 1/16	1 3/4	1 3/4	1 1/32
SA-606	1 1/4	4 7/32	2 1/8	1 7/8	1 7/8	1 3/32
SA-607	1 5/16	4 7/32	2 1/8	1 7/8	1 7/8	1 3/32
SA-609	1 7/16	4 11/32	2 1/4	2 1/8	2 1/8	1 5/32
SA-610	1 1/2	4 11/32	2 1/4	2 1/4	2 1/4	1 5/32
SA-712	1 5/8	4 11/32	2 3/8	2 3/8	2 3/8	1 3/16
SA-716	1 7/8	4 11/32	2 3/8	2 5/8	2 5/8	1 3/16

Universal wrenches must not be used with impact drivers. Maximum operating angle is 30°.

3/4" Square Drive Budd Wheel Sockets 13/16" Square and Combo. 13/16" Square – 1 1/2" Hex



Part Number	Drive	Overall Length In.	Overall Length mm	
BW-7626	3/4" Square	2	51	13/16" Square
BW-748	3/4" Square	3 3/8	86	Combo. 13/16 Square – 1 1/2" Hex

3/4" Square Drive Sockets, Metric

6 Point, Standard Length

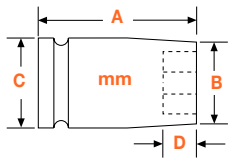

Part Number 6 Point	Hex Opening mm	Overall Length (A)	Diameter Nose End (B)	Diameter Drive End (C)	Opening Depth (D)
17mm17	17	51	31.8	38.1	11.2
18mm17	18	51	31.8	38.1	11.2
19mm17	19	51	31.8	38.1	11.9
20mm17	20	51	33.3	38.1	11.9
21mm17	21	51	34.9	38.1	13.5
22mm17	22	51	38.1	38.1	14.3
22mm47*	22	51	33.3	34.9	14.3
23mm17	23	51	38.1	38.1	15.9
24mm17	24	51	38.1	38.1	15.9
24mm47*	24	51	34.9	34.9	15.9
25mm17	25	51	41.3	41.3	15.9
26mm17	26	51	41.3	41.3	15.9
27mm17	27	51	44.4	44.4	17.5
27mm47*	27	51	38.1	38.1	17.5
28mm17	28	54	44.4	44.4	19.1
29mm17	29	54	47.6	44.4	19.1
30mm17	30	54	47.6	44.4	19.1
30mm47*	30	54	41.3	41.3	19.1
32mm17	32	54	50.8	44.4	20.6
32mm47*	32	54	44.4	44.4	20.6
33mm17	33	54	50.8	44.4	20.6
34mm17	34	54	54.0	54.0	20.6
35mm17	35	54	54.0	54.0	20.6
36mm17	36	57	57.1	54.0	23.8
37mm17	37	57	57.1	54.0	23.8
38mm17	38	57	57.1	54.0	25.4
41mm17	41	57	63.5	54.0	31.8
46mm17	46	57	69.9	54.0	31.8

*Thin Wall

3/4" Square Drive Sockets, Metric

6 Point, Extra Long Length

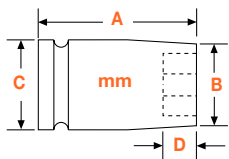

Part Number 6 Point	Hex Opening mm	Overall Length (A)	Diameter Nose End (B)	Diameter Drive End (C)	Opening Depth (D)
21mm37	21	102	34.9	38.1	13.5
21mm57*	21	102	34.9	34.9	13.5
22mm37	22	102	36.5	38.1	14.3
22mm57*	22	102	34.9	34.9	14.3
23mm37	23	102	38.1	38.1	15.9
24mm37	24	102	38.1	38.1	15.9
24mm57*	24	102	34.9	34.9	15.9
25mm37	25	102	38.1	38.1	15.9
26mm37	26	102	41.3	41.3	15.9
27mm37	27	102	41.3	41.3	17.5

*Thin Wall

Refer to Page iv for description of Rapid Select.

3/4" Square Drive Sockets, Metric



6 Point , Extra Long Length (continued)

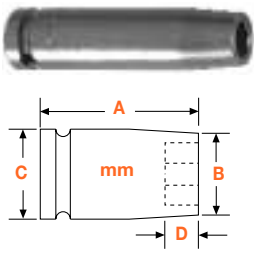

Part Number 6 Point	Hex Opening mm	Overall Length (A)	Diameter Nose End (B)	Diameter Drive End (C)	Opening Depth (D)
27mm57*	27	101.6	38.1	38.1	17.5
28mm37	28	101.6	44.4	44.4	19.1
29mm37	29	101.6	44.4	44.4	19.1
30mm37	30	101.6	44.4	44.4	19.1
30mm57*	30	101.6	42.9	42.9	19.1
32mm37	32	101.6	47.6	44.4	20.6
33mm37	33	101.6	50.8	44.4	20.6
34mm37	34	101.6	54.0	54.0	20.6
35mm37	35	101.6	54.0	54.0	20.6
36mm37	36	101.6	54.0	54.0	23.8
41mm37	41	101.6	63.5	54.0	28.6

*Thin Wall

3/4" Square Drive Sockets for Spline Fasteners Standard Length

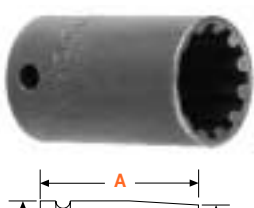

Part Number	Spline Size	Nominal Size	Overall Length (A)		Diameter Nose End (B)		Diameter Drive End (C)	
			In.	mm	In.	mm	In.	mm
CMS-7426	26	13/16	1 3/4	45	1 1/8	29	1 3/8	35
CMS-7428	28	7/8	1 13/16	46	1 1/4	32	1 3/8	35
CMS-7430	30	15/16	1 7/8	48	1 3/8	35	1 3/8	35
CMS-7432	32	1	1 15/16	49	1 7/16	37	1 7/16	37

Apex spline sockets conform to military specifications MS-37787 and MIL-W-8982C.

3/4" Square Drive Extensions 2 1/4" to 15" (57mm to 381mm) Length



Part Number	Male Square In.	Type of Lock	Overall Length	
			In.	mm
EX-753	3/4	7/32 Drill Hole	2 1/4	57
EX-753-B	3/4	Ball	2 1/4	57
EX-755-4	3/4	7/32 Drill Hole	4	102
EX-755-B-4	3/4	Ball	4	102
EX-755-6	3/4	7/32 Drill Hole	6	152
EX-755-B-6	3/4	Ball	6	152
EX-755-8	3/4	7/32 Drill Hole	8	203
EX-755-B-8	3/4	Ball	8	203
EX-755-10	3/4	7/32 Drill Hole	10	254
EX-755-B-10	3/4	Ball	10	254
EX-755-12	3/4	7/32 Drill Hole	12	305
EX-755-B-12	3/4	Ball	12	305
EX-755-15	3/4	7/32 Drill Hole	15	381
EX-755-B-15	3/4	Ball	15	381

3/4" Square Drive Adapters

1/2" to 1" Male Square



Part Number	Male Square In.	Female Square In.	Type of Lock	Overall Length	
				In.	mm
EX-506	1/2	3/4	Pin	2	51
EX-506-B	1/2	3/4	Ball	2	51
EX-510-3	1/2	3/4	Pin	3	76
EX-510-B-3	1/2	3/4	Ball	3	76
EX-510-4	1/2	3/4	Pin	4	102
EX-510-B-4	1/2	3/4	Ball	4	102
EX-510-B-5	1/2	3/4	Ball	5	127
EX-510-6	1/2	3/4	Pin	6	152
EX-510-B-6	1/2	3/4	Ball	6	152
EX-510-8	1/2	3/4	Pin	8	203
EX-510-B-8	1/2	3/4	Ball	8	203
EX-625	5/8	3/4	Pin	2	51
EX-625-B	5/8	3/4	Ball	2	51
EX-628-3	5/8	3/4	Pin	3	76
EX-1000	1	3/4	9/32 Drill Hole	2 9/16	65
EX-1000-B	1	3/4	Ball	2 9/16	65

3/4" Square Drive Universal Adapters

3/4" Male Square



Part Number	Male Sq. In.	Female Sq. In.	Type of Lock	Overall Length		Largest Diameter	
				In.	mm	In.	mm
MF-75	3/4	3/4	7/32 Drill Hole	4	102	1 1/2	38
MF-75B	3/4	3/4	Ball	4	102	1 1/2	38
MF-76	3/4	3/4	7/32 Drill Hole	4 3/8	111	1 3/4	45
MF-76B	3/4	3/4	Ball	4 3/8	111	1 3/4	45
MF-79	3/4	3/4	7/32 Drill Hole	4 1/2	114	2	51
MF-79B	3/4	3/4	Ball	4 1/2	114	2	51

1" Square Drive Sockets, SAE



6 Point and Double Hex , Standard Length

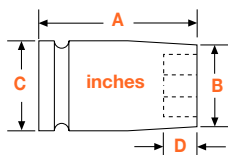

Part Number 6 Point	Part Number Double Hex	Hex Opening In.	Overall Length (A)	Diameter Nose End (B)	Diameter Drive End (C)	Opening Depth (D)
8124	8124-D	3/4	2 1/8	1 5/16	2	13/16
8126	-	13/16	2 1/8	1 3/8	2	13/16
8128	8128-D	7/8	2 1/8	1 1/2	2	13/16
8130	8130-D	15/16	2 1/8	1 1/2	2	13/16
8132	8132-D	1	2 1/8	1 5/8	2	13/16
8134	8134-D	1 1/16	2 1/8	1 11/16	2	13/16
8136	8136-D	1 1/8	2 1/8	1 3/4	2	13/16
8138	8138-D	1 3/16	2 1/8	2 1/8	2	13/16
8140	8140-D	1 1/4	2 1/8	2 1/8	2 1/8	13/16
8142	8142-D	1 5/16	2 1/8	2 1/8	2 1/8	13/16
8144	8144-D	1 3/8	2 1/8	2 1/8	2 1/8	13/16
8146	8146-D	1 7/16	2 1/4	2 1/4	2 1/8	15/16
8148	8148-D	1 1/2	2 1/4	2 1/4	2 1/8	15/16
-	8150-D	1 9/16	2 1/4	2 3/8	2 1/8	15/16
8152	-	1 5/8	2 3/8	2 1/2	2 1/8	15/16
8154	8154-D	1 11/16	2 3/8	2 1/2	2 1/8	15/16
-	8156-D	1 3/4	2 3/8	2 5/8	2 5/8	1 1/16
8158	-	1 13/16	2 1/2	2 3/4	2 5/8	1 1/16
8160	8160-D	1 7/8	2 1/2	2 3/4	2 5/8	1 1/16
8162	8162-D	1 15/16	2 1/2	2 7/8	2 5/8	1 1/16
8164	8164-D	2	2 5/8	3	2 5/8	1 3/16
8166	-	2 1/16	2 5/8	3	2 5/8	1 3/16
8168	-	2 1/8	2 5/8	3 1/8	2 5/8	1 3/16
8170	-	2 3/16	2 3/4	3 1/4	3 1/4	1 5/16
8172	-	2 1/4	2 3/4	3 1/4	3 1/4	1 5/16
8174	-	2 5/16	2 3/4	3 3/8	3 1/4	1 3/8
8176	-	2 3/8	2 7/8	3 1/2	3 1/4	1 3/8
8178	-	2 7/16	2 7/8	3 1/2	3 1/4	1 3/8
8180	-	2 1/2	2 7/8	3 3/4	3 1/4	1 3/8
8182	-	2 9/16	3	3 3/4	3 1/4	1 1/2
8184	-	2 5/8	3	3 3/4	3 1/4	1 1/2
8186	-	2 11/16	3	4	3 1/4	1 1/2
8188	-	2 3/4	3 1/8	4	3 1/4	1 5/8
8190	-	2 13/16	3 1/8	4	3 1/4	1 5/8

1" Square Drive Sockets, SAE

6 Point and Double Hex, Thin Wall Standard Length

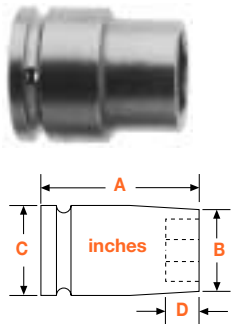

Part Number 6 Point	Part Number Double Hex	Hex Opening In.	Overall Length (A)	Diameter Nose End (B)	Diameter Drive End (C)	Opening Depth (D)
8430	8430-D	15/16	2 1/8	1 7/16	1 7/8	13/16
8432	8432-D	1	2 1/8	1 1/2	1 7/8	13/16
8434	8434-D	1 1/16	2 1/8	1 9/16	1 7/8	13/16
8436	8436-D	1 1/8	2 1/8	1 5/8	1 7/8	13/16
8438	8438-D	1 3/16	2 1/8	1 3/4	2	13/16
8440	8440-D	1 1/4	2 1/8	1 13/16	2	13/16
8442	8442-D	1 5/16	2 1/8	1 7/8	2	13/16
8444	8444-D	1 3/8	2 1/8	1 15/16	2	13/16
8446	8446-D	1 7/16	2 1/4	2	2	15/16
8448	8448-D	1 1/2	2 1/4	2 1/8	2 1/8	15/16
8452	-	1 5/8	2 3/8	2 5/16	2 1/8	15/16
8454	-	1 11/16	2 3/8	2 3/8	2 1/8	15/16
8456	-	1 3/4	2 3/8	2 7/16	2 1/8	1 1/16
8458	-	1 13/16	2 1/2	2 9/16	2 1/8	1 1/16
8460	-	1 7/8	2 1/2	2 5/8	2 5/8	1 1/16
8464	-	2	2 5/8	2 3/4	2 5/8	1 3/16
8468	-	2 1/8	2 5/8	2 15/16	2 5/8	1 3/16
8472	-	2 1/4	2 3/4	3 1/8	2 5/8	1 5/16
8480	-	2 1/2	2 7/8	3 3/8	3 1/4	1 7/16

6 Point, Long Length

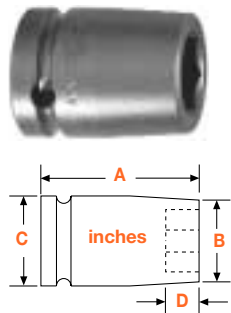

Part Number 6 Point	Hex Opening In.	Overall Length (A)	Diameter Nose End (B)	Diameter Drive End (C)	Opening Depth (D)
8226	13/16	3	1 3/8	2 1/8	17/32
8228	7/8	3	1 7/16	2 1/8	9/16
8230	15/16	3	1 1/2	2 1/8	5/8
8232	1	3	1 5/8	2 1/8	5/8
8236	1 1/8	3	1 3/4	2 1/8	3/4
8240	1 1/4	3	2 1/8	2 1/8	13/16
8242	1 5/16	3	2 1/8	2 1/8	13/16
8244	1 3/8	3	2 1/8	2 1/8	13/16
8246	1 7/16	3	2 1/4	2 1/8	15/16
8248	1 1/2	3 1/4	2 1/4	2 1/8	15/16

1" Square Drive Sockets, SAE



6 Point, Extra Long Length

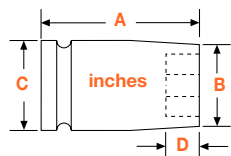

Part Number 6 Point	Hex Opening In.	Overall Length (A)	Diameter Nose End (B)	Diameter Drive End (C)	Opening Depth (D)
8324	3/4	4 1/4	1 1/4	2 1/8	15/32
8326	13/16	4 1/4	1 3/8	2 1/8	17/32
8328	7/8	4 1/4	1 7/16	2 1/8	9/16
8330	15/16	4 1/4	1 1/2	2 1/8	5/8
8332	1	4 1/4	1 9/16	2 1/8	5/8
8334	1 1/16	4 1/4	1 5/8	2 1/8	11/16
8336	1 1/8	4 1/4	1 3/4	2 1/8	3/4
8338	1 3/16	4 1/4	1 7/8	2 1/8	3/4
8340	1 1/4	4 1/4	2 1/8	2 1/8	13/16
8342	1 5/16	4 1/4	2 1/8	2 1/8	13/16
8344	1 3/8	4 1/4	2 1/8	2 1/8	13/16
8346	1 7/16	4 1/4	2 1/4	2 1/8	15/16
8348	1 1/2	4 1/4	2 1/4	2 1/8	1
8350	1 9/16	4 1/4	2 3/8	2 1/8	1
8352	1 5/8	4 1/4	2 1/2	2 1/8	1 1/8
8354	1 11/16	4 1/4	2 1/2	2 1/8	1 1/8
8356	1 3/4	4 1/4	2 5/8	2 5/8	1 1/8
8358	1 13/16	4 1/4	2 3/4	2 5/8	1 1/4
8360	1 7/8	4 1/4	2 3/4	2 5/8	1 1/4
8362	1 15/16	4 1/4	2 7/8	2 5/8	1 1/4
8364	2	4 3/8	2 7/8	2 5/8	1 3/8
8366	2 1/16	4 3/8	3	2 5/8	1 3/8
8368	2 1/8	4 3/8	3 1/8	2 5/8	1 3/8
8370	2 3/16	4 1/2	3 1/8	2 5/8	1 1/2
8372	2 1/4	4 1/2	3 1/4	3 1/4	1 1/2
8374	2 5/16	4 1/2	3 3/8	3 1/4	1 1/2
8376	2 3/8	4 1/2	3 1/2	3 1/4	1 5/8
8378	2 7/16	4 1/2	3 1/2	3 1/4	1 5/8
8380	2 1/2	4 1/2	3 1/2	3 1/4	1 5/8
8382	2 9/16	4 1/2	3 3/4	3 1/4	1 3/4
8384	2 5/8	4 1/2	3 3/4	3 1/4	1 3/4
8386	2 11/16	4 1/2	4	3 1/4	1 3/4
8388	2 3/4	4 5/8	4	3 1/4	1 7/8
8390	2 13/16	4 5/8	4	3 1/4	1 7/8

6 Point, Thin Wall, Extra Long Length

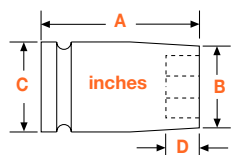

Part Number 6 Point	Hex Opening In.	Overall Length (A)	Diameter Nose End (B)	Diameter Drive End (C)	Opening Depth (D)
8528	7/8	4 1/4	1 7/16	2 1/8	9/16
8530	15/16	4 1/4	1 1/2	2 1/8	5/8
8534	1 1/16	4 1/4	1 9/16	2 1/8	3/4
8536	1 1/8	4 1/4	1 5/8	2 1/8	3/4
8540	1 1/4	4 1/4	1 13/16	2 1/8	13/16
8542	1 5/16	4 1/4	1 7/8	2 1/8	13/16
8548	1 1/2	4 1/4	2 1/8	2 1/8	1

1" Square Drive Sockets, SAE



Single Square and Double Square, Standard Length

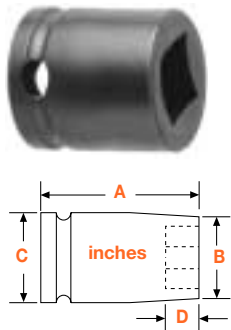

Part No. Single Square	Part No. Double Square	Square Opening In.	Overall Length (A)	Diameter Nose End (B)	Diameter Drive End (C)	Opening Depth (D)
8620	-	5/8	2 1/8	1 3/8	2	13/16
-	8622-D	11/16	2 1/8	1 1/2	2	13/16
8624	8624-D	3/4	2 1/8	1 5/8	2	13/16
8626	8626-D	13/16	2 1/8	1 3/4	2	13/16
8628	8628-D	7/8	2 1/8	2	2	13/16
8630	8630-D	15/16	2 1/8	2 1/8	2 1/8	13/16
8632	8632-D	1	2 1/8	2 1/8	2 1/8	13/16
8634	8634-D	1 1/16	2 1/8	2 1/8	2 1/8	13/16
8636	8636-D	1 1/8	2 1/4	2 1/4	2 1/8	15/16
8638	8638-D	1 3/16	2 1/4	2 1/4	2 1/8	15/16
8640	8640-D	1 1/4	2 1/4	2 3/8	2 1/8	15/16
8642	-	1 5/16	2 1/4	2 1/2	2 1/8	15/16
8644	8644-D	1 3/8	2 5/16	2 5/8	2 5/8	1
8646	8646-D	1 7/16	2 3/8	2 5/8	2 5/8	1
8648	8648-D	1 1/2	2 3/8	2 3/4	2 5/8	1 1/16
8650	-	1 9/16	2 3/8	2 3/4	2 5/8	1 1/16
8652	8652-D	1 5/8	2 1/2	2 7/8	2 5/8	1 1/16
8654	8654-D	1 11/16	2 1/2	3 1/4	3 1/4	1 1/8
8656	-	1 3/4	2 1/2	3 1/2	3 1/4	1 1/8
8658	-	1 13/16	2 5/8	3 1/2	3 1/4	1 1/4
8660	-	1 7/8	2 5/8	3 1/2	3 1/4	1 1/4
8662	-	1 15/16	2 5/8	3 3/4	3 1/4	1 1/4
8664	8664-D	2	2 3/4	3 3/4	3 1/4	1 5/16

Budd Wheel Sockets

13/16" Square and Combo. 13/16" Square 1 1/2" Hex



Part Number	Drive	Overall Length		
		In.	mm	
BW-8626	1" Square	2 1/8	54	13/16" Square
BW-848	1" Square	3 3/4	95	Combo. 13/16 Square—1 1/2" Hex
BW-848-F	1" Square	3 3/4	95	Combo. 13/16 Square—1 1/2" Hex for mag. wheels

1" Square Drive Sockets, Metric



6 Point, Standard Length

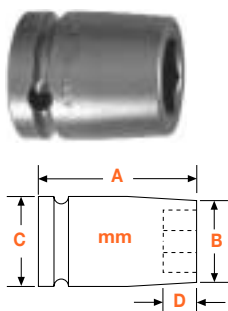

Part Number 6 Point	Hex Opening mm	Overall Length (A)	Diameter Nose End (B)	Diameter Drive End (C)	Opening Depth (D)
21mm18	21	54	34.9	50.8	13.5
22mm18	22	54	38.1	50.8	14.2
23mm18	23	54	38.1	50.8	20.6
24mm18	24	54	38.1	50.8	20.6
25mm18	25	54	41.3	50.8	20.6
26mm18	26	54	41.3	50.8	20.6
27mm18	27	54	42.9	50.8	20.6
28mm18	28	54	44.4	50.8	20.6
29mm18	29	54	47.6	50.8	20.6
30mm18	30	54	50.8	50.8	20.6
30mm48*	30	54	44.4	54.0	20.6
32mm18	32	54	54.0	54.0	20.6
33mm18	33	54	54.0	54.0	20.6
34mm18	34	54	54.0	54.0	20.6
35mm18	35	54	54.0	54.0	20.6
36mm18	36	57	57.1	54.0	23.9
37mm18	37	57	57.1	54.0	23.9
38mm18	38	57	57.1	54.0	23.9
41mm18	41	60	63.5	54.0	23.9
42mm18	42	60	63.5	54.0	23.9
46mm18	46	64	69.8	66.7	26.9
47mm18	47	64	69.8	66.7	26.9
48mm18	48	64	69.8	66.7	26.9
50mm18	50	66	76.2	66.7	30.2

*Thin Wall

6 Point, Long Length

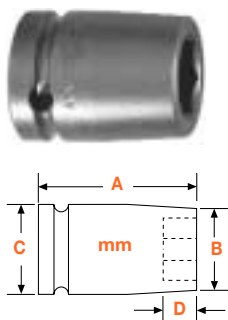

Part Number 6 Point	Hex Opening mm	Overall Length (A)	Diameter Nose End (B)	Diameter Drive End (C)	Opening Depth (D)
21mm38	21	108	34.9	54.0	13.5
23mm38	23	108	36.5	54.0	15.9
24mm38	24	108	38.1	54.0	15.9
27mm38	27	108	41.3	54.0	17.5
28mm38	28	108	44.4	54.0	19.1
29mm38	29	108	47.6	54.0	19.1
32mm38	32	108	54.0	54.0	20.6
33mm38	33	108	54.0	54.0	20.6
35mm38	35	108	54.0	54.0	20.6
36mm38	36	108	54.0	54.0	23.8
37mm38	37	108	57.1	54.0	23.8
38mm38	38	108	57.1	54.0	25.4
41mm38	41	108	63.5	54.0	28.6
46mm38	46	108	69.8	66.7	31.8
47mm38	47	108	69.8	66.7	31.8
50mm38	50	111	73.0	66.7	34.9

1" Square Drive Sockets for Spline Fasteners

Standard Length

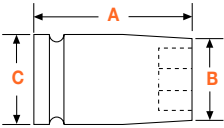

Part Number	Spline Size	Nominal Size	Overall Length (A)		Diameter Nose End (B)		Diameter Drive End (C)	
			In.	mm	In.	mm	In.	mm
CMS-8432	32	1	2 7/16	62	1 7/16	37	2	51
CMS-8434	34	1 1/16	2 1/2	64	1 17/32	39	2	51

Apex spline sockets conform to military specifications MS-37787 and MIL-W-8982C.

1" Square Drive Extensions

2 13/16" to 15" (71mm to 381mm) Length



Part Number	Male Square In.	Type of Lock	Overall Length	
			In.	mm
EX-1001	1	9/32 Drill Hole	2 13/16	71
EX-1001-B	1	Ball	2 13/16	71
EX-1003-4	1	9/32 Drill Hole	4	102
EX-1003-B-4	1	Ball	4	102
EX-1003-6	1	9/32 Drill Hole	6	152
EX-1003-B-6	1	Ball	6	152
EX-1003-8	1	9/32 Drill Hole	8	203
EX-1003-B-8	1	Ball	8	203
EX-1003-10	1	9/32 Drill Hole	10	254
EX-1003-B-10	1	Ball	10	254
EX-1003-12	1	9/32 Drill Hole	12	305
EX-1003-B-12	1	Ball	12	305
EX-1003-15	1	9/32 Drill Hole	15	381
EX-1003-B-15	1	Ball	15	381

1" Square Drive Adapters

3/4" to 1 1/2" Male Square



Part Number	Male Square In.	Female Square In.	Type of Lock	Overall Length	
				In.	mm
EX-754	3/4	1	7/32 Drill Hole	2 13/16	71
EX-754-B	3/4	1	Ball	2 13/16	71
EX-756-4	3/4	1	7/32 Drill Hole	4	102
EX-756-B-4	3/4	1	Ball	4	102
EX-756-6	3/4	1	7/32 Drill Hole	6	152
EX-756-B-6	3/4	1	Ball	6	152
EX-756-8	3/4	1	7/32 Drill Hole	8	203
EX-756-B-8	3/4	1	Ball	8	203
EX-1101	1 1/2	1	3/8 Drill Hole	3 9/16	91

1" Square Drive Universal Adapters

3/4" to 1" Male Square



Part Number	Male Sq. In.	Female Sq. In.	Type of Lock	Overall Length		Largest Diameter	
				In.	mm	In.	mm
MF-77	3/4	1	7/32 Drill Hole	4 3/4	121	2	51
MF-77B	3/4	1	Ball	4 3/4	121	2	51
MF-82	1	1	9/32 Drill Hole	5	127	2	51
MF-82B	1	1	Ball	5	127	2	51

Universal wrenches must not be used with impact drivers. Maximum operating angle is 30°.

1 1/4" Square Drive Adapter

1" Male Square



Part Number	Male Square In.	Female Square In.	Type of Lock	Overall Length	
				In.	mm
EX-1008	1	1 1/4	9/32 Drill Hole	3 1/4	83

1 1/2" Square Drive Sockets, SAE



6 Point, Standard Length

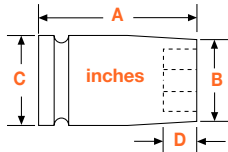

Part Number 6 Point	Hex Opening In.	Overall Length (A)	Diameter Nose End (B)	Diameter Drive End (C)	Opening Depth (D)
9140	1 1/4	2 3/4	2 1/4	3	1 1/4
9142	1 5/16	2 3/4	2 5/16	3	1 1/4
9144	1 3/8	2 3/4	2 3/8	3	1 1/4
9146	1 7/16	2 3/4	2 7/16	3	1 1/4
9148	1 1/2	2 3/4	2 1/2	3	1
9150	1 9/16	2 3/4	2 5/8	3	1
9152	1 5/8	2 7/8	2 3/4	3	1 1/8
9154	1 11/16	2 7/8	2 13/16	3	1 1/8
9156	1 3/4	2 7/8	2 7/8	3	1 1/8
9158	1 13/16	3	3	3	1 3/8
9160	1 7/8	3	3 1/8	3	1 1/4
9162	1 15/16	3	3 1/4	3 1/4	1 1/4
9164	2	3 1/8	3 1/4	3 1/4	1 3/8
9166	2 1/16	3 1/8	3 1/4	3 1/4	1 3/8
9168	2 1/8	3 1/8	3 1/4	3 1/4	1 3/8
9170	2 3/16	3 1/4	3 1/4	3 1/4	1 1/2
9172	2 1/4	3 1/4	3 3/8	3 1/4	1 1/2
9174	2 5/16	3 1/4	3 3/8	3 1/4	1 1/2
9176	2 3/8	3 3/8	3 1/2	3 1/4	1 5/8
9178	2 7/16	3 3/8	3 1/2	3 1/4	1 5/8
9180	2 1/2	3 3/8	3 3/4	3 1/4	1 5/8
9182	2 9/16	3 1/2	3 3/4	3 1/4	1 3/4
9184	2 5/8	3 1/2	4	4	1 3/4
9186	2 11/16	3 1/2	4	4	1 3/4
9190	2 13/16	3 5/8	4 1/4	4	1 7/8
9192	2 7/8	3 5/8	4 1/2	4	1 7/8
9194	2 15/16	3 5/8	4 1/2	4	1 7/8
9196	3	3 5/8	4 1/2	4	1 7/8
9198	3 1/16	3 5/8	4 3/4	4	1 7/8
91100	3 1/8	3 7/8	4 3/4	4	2 1/8
91102	3 3/16	3 7/8	4 3/4	4	2 1/8
91104	3 1/4	4	5	4	2 1/4
91106	3 5/16	4	5	4	2 1/4
91108	3 3/8	4	5	4	2 1/4
91110	3 7/16	4 1/8	5 1/4	4	2 3/8
91112	3 1/2	4 1/4	5 1/4	4	2 1/2
91116	3 5/8	4 1/4	5 1/4	4	2 1/2
91120	3 3/4	4 1/4	5 1/2	4	2 1/2
91124	3 7/8	4 1/4	5 3/4	4	2 1/2
91128	4	4 3/8	5 3/4	4	2 5/8
91132	4 1/8	4 1/2	6	4	2 3/4
91136	4 1/4	4 3/4	6	4	3
91140	4 3/8	4 3/4	6 1/2	4	3
91144	4 1/2	4 7/8	6 1/2	4	3 1/8
91152	4 3/4	5 1/8	6 3/4	4	3 3/8

1 1/2" Square Drive Adapters

1" Male Square



Part Number	Male Square In.	Female Square In.	Type of Lock	Overall Length In.	Overall Length mm
EX-1005	1	1 1/2	9/32 Drill Hole	3 15/16	100
EX-1005-B	1	1 1/2	Ball	3 15/16	100

2 1/2" Square Drive Sockets, SAE

6 Point, Standard Length

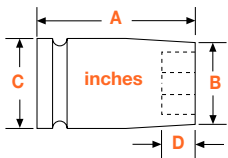

Part Number 6 Point	Hex Opening In.	Overall Length (A)	Diameter Nose End (B)	Diameter Drive End (C)	Opening Depth (D)
0172	2 1/4	4 1/8	3 3/4	5	1 1/2
0176	2 3/8	4 1/8	3 7/8	5	1 3/4
0180	2 1/2	4 1/8	4	5	1 3/4
0184	2 5/8	4 1/8	4	5	1 7/8
0188	2 3/4	4 1/8	4 1/4	5	1 7/8
0192	2 7/8	4 1/8	4 1/2	5	1 7/8
01100	3 1/8	4 3/8	4 7/8	5	2 1/8
01112	3 1/2	4 3/4	5 1/2	5 1/2	2 1/2
01116	3 5/8	4 3/4	5 1/2	5 1/2	2 1/2
01120	3 3/4	4 3/4	5 3/4	5 3/4	2 1/2
01124	3 7/8	4 3/4	6	6	2 1/2
01128	4	4 7/8	6	6	2 5/8
01136	4 1/4	5 1/4	6	6	3
01144	4 1/2	5 3/8	6 1/2	6	3 1/8

2 1/2" Square Drive Adapter

1 1/2" Male Square



Part Number	Male Square In.	Female Square In.	Type of Lock	Overall Length In.	Overall Length mm
EX-1105	1 1/2	2 1/2	3/8 Drill Hole	5 3/8	137

APEX® Solutions

Does Apex offer sockets for the installation of grease fittings?

Specially designed Apex sockets are the easy way to install or remove grease fittings.

(See page 153)



What's the real advantage of using socket adapters?

Socket adapters are an easy and economical solution for applications that require several different nut sizes.

(See pages 158 & 159)



Does Apex offer tap holding sockets?

Apex offers a wide variety of tap holding adapters. These adapters allow you to easily convert your power tool into a tap drill.

(See page 152)

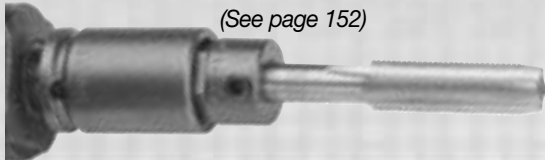

What's the advantage of a male hex drive socket?

A male hex drive socket lets you quickly accommodate a different nut size without pulling the primary socket off the power tool.

(See page 160)



Reversible Sockets for SAE Hex Head Sheet Metal Screws

Standard



*Tapered Ends

Part Number	Hex Size	Overall Length	Outside Diameter	Roll Pin Part Number
SW-350	1/4	9/16	3/8	21-S-078-0375
SW-90	1/4	9/16	7/16	21-S-078-0437
SW-90-B*	1/4	9/16	7/16	21-S-078-0437
SW-984	5/16	9/16	9/16	21-S-078-0562
SH-575	11/32	9/16	9/16	21-S-078-0562
SH-400	3/8	11/16	11/16	21-S-078-0687
SH-401	7/16	23/32	3/4	21-S-078-0750
SH-402	13/16	3/4	13/16	21-S-078-0750

Magnetic



*Tapered Ends

Part Number	Hex Size	Overall Length	Outside Diameter	Spring Pin Part Number
MSW-350	1/4	31/32	3/8	21-S-078-0375
MSW-90	1/4	31/32	7/16	21-S-078-0437
MSW-90-B*	1/4	31/32	7/16	21-S-078-0437
MSW-984	5/16	31/32	9/16	21-S-078-0562
MSW-984-B*	5/16	31/32	9/16	21-S-078-0562
MSH-575	11/32	31/32	9/16	21-S-078-0562
MSH-400	3/8	1 1/8	11/16	21-S-078-0687
MSH-401	7/16	1 5/32	3/4	21-S-078-0750
MSH-402	13/16	1 3/16	13/16	21-S-078-0750

Shanks for Reversible Sockets



Part Number	Male Hex Power Drive	Male Hex Size	Overall Length
SH-629	1/4	1/4	2
SH-629-P	1/4	1/4	2 Pin Lock
SH-629-3	1/4	1/4	3
SH-629-4	1/4	1/4	4
SH-629-5	1/4	1/4	5
SH-629-6	1/4	1/4	6
SH-57	1/4	1/4	2 Full Length Hex
SH-57-3	1/4	1/4	3 Full Length Hex
SH-57-4	1/4	1/4	4 Full Length Hex
SH-57-6	1/4	1/4	6 Full Length Hex
SH-57-8	1/4	1/4	8 Full Length Hex
SH-59	1/4	5/16	2
SH-59-3	1/4	5/16	3
SH-59-4	1/4	5/16	4
SH-59-6	1/4	5/16	6
SH-412	1/4	3/8	2
SH-413	1/4	7/16	2
SH-414	1/4	1/2	2
SH-913	7/16	5/16	2
SH-404	7/16	3/8	2
SH-406	7/16	1/2	2

Tap Holding Sockets



Male Hex Drive, SAE



Part Number	Tap Size	Male Hex	Socket Length		Socket Diameter	
			In.	mm	In.	mm
SJ-935-1/4	1/4	7/16	15/16	24	5/8	16
SJ-935-5/16	5/16	1/2	15/16	24	5/8	16
SJ-935-3/8FS	3/8	9/16	1	25	21/32	17
SJ-935-7/16	7/16	5/8	1	25	3/4	19
SJ-935-1/2	1/2	3/4	1 1/4	32	7/8	22

Male Hex Drive, Metric

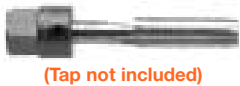

Part Number	Tap Size	Male Hex	Socket Length		Socket Diameter	
			In.	mm	In.	mm
SJ-935-10MXM6	M6	10	15/16	24	5/8	16
SJ-935-12MXM8	M8	12	15/16	24	5/8	16
SJ-935-14MXM10	M10	14	1	25	21/32	17
SJ-935-17MXM8	M8	17	1	25	13/16	21
SJ-935-17MXM12	M12	17	1	25	13/16	21

Female Square Drive, SAE



Part Number	Tap Size	Female Square	Socket Length		Socket Diameter	
			In.	mm	In.	mm
HC-100-10	#10	3/8	1 1/2	38	3/4	19
HC-100-1/4	1/4	3/8	1 1/2	38	3/4	19
HC-100-5/16	5/16	3/8	1 1/2	38	3/4	19
HC-100-3/8FS	3/8	3/8	1 1/2	38	3/4	19
HC-100-7/16	7/16	3/8	1 1/2	38	3/4	19
HC-100-1/2	1/2	3/8	1 1/2	38	3/4	19
HC-100-5/8	5/8	3/8	1 3/4	46	1	25
HC-100-3/4	3/4	3/8	2	51	1	25
HE-100-1/4	1/4	1/2	1 1/2	38	7/8	22
HE-100-5/16	5/16	1/2	1 1/2	38	7/8	22
HE-100-3/8FS	3/8	1/2	1 1/2	38	7/8	22
HE-100-7/16	7/16	1/2	1 1/2	38	7/8	22
HE-100-1/2	1/2	1/2	1 5/8	41	7/8	22
HE-100-5/8	5/8	1/2	1 3/4	46	1	25
HE-100-3/4	3/4	1/2	2	51	1	25

Grease Fitting Sockets



For Angled Grease Fittings, Deep and Shallow Broach Depth



Part Number		Hex Size	Square Drive	Overall Length		Broach Depth		Magnet Depth	
6 Point	Magnetic			In.	mm	In.	mm	In.	mm
ZN-112	-	3/8	1/4	1 1/4	32	9/16	14	-	-
ZN-312	MZN-312	3/8	3/8	1 1/2	38	9/16	14	7/32	6
ZN-512	-	3/8	1/2	1 1/2	32	9/16	14	-	-
ZN-114	-	7/16	1/4	1 1/4	32	7/16	11	-	-
ZN-314	MZN-314	7/16	3/8	1 1/2	38	7/16	11	7/16	11
ZN-514	MZN-514	7/16	1/2	1 1/2	38	7/16	11	7/16	11
ZE-112	-	3/8	1/4	1 1/4	32	1/8	3	-	-
ZE-312	-	3/8	3/8	1 1/2	38	1/8	3	-	-
ZE-512	-	3/8	1/2	1 1/2	32	1/8	3	-	-
ZE-314	-	7/16	3/8	1 1/2	38	3/16	5	-	-
ZE-514	-	7/16	1/2	1 1/2	38	3/16	5	-	-

For Straight Grease Fittings



Part Number		Hex Size	Square Drive	Overall Length		Broach Depth		Magnet Depth	
6 Point	Magnetic			In.	mm	In.	mm	In.	mm
ZA-110	MZA-110	5/16	1/4	1	25	1/8	3	21/64	8
ZA-310	MZA-310	5/16	3/8	1 1/4	32	1/8	3	21/64	8
ZA-510	MZA-510	5/16	1/2	1 1/2	38	1/8	3	19/64	7
ZA-112	-	3/8	1/4	1	25	1/8	3	-	-
ZA-312	-	3/8	3/8	1 1/4	32	1/8	3	-	-
ZA-512	-	3/8	1/2	1 1/2	38	1/8	3	-	-
ZA-314	MZA-314	7/16	3/8	1 1/4	32	3/16	5	23/64	9
ZA-514	MZA-514	7/16	1/2	1 1/2	38	3/16	5	3/8	10

Drill Holders



1/4" Male Hex Drive



Part Number	Drill Size	Overall Length		Body Diameter	
		In.	mm	In.	mm
WJ-284-7/64	7/64	2 5/8	67	1/2	13
WJ-284-1/8	1/8	2 5/8	67	5/8	16
WJ-284-9/64	9/64	2 5/8	67	5/8	16
WJ-284-5/32	5/32	2 5/8	67	3/4	19
WJ-284-3/16	3/16	2 5/8	67	3/4	19
WJ-284-1/4 	1/4	2 5/8	67	3/4	19
WJ-284-5/16	5/16	2 5/8	67	3/4	19
WJ-284-3/8	3/8	2 5/8	67	1	25
WJ-284-13/32	13/32	2 5/8	67	1	25

7/16" Male Hex Drive



Part Number	Drill Size	Overall Length		Body Diameter	
		In.	mm	In.	mm
WJ-265-1/8	1/8	2 3/8	60	5/8	16
WJ-265-9/64	9/64	2 3/8	60	5/8	16
WJ-265-13/64	13/64	2 3/8	60	3/4	19
WJ-265-5/32	5/32	2 3/8	60	3/4	19
WJ-265-3/16	3/16	2 3/8	60	3/4	19
WJ-265-1/4	1/4	2 3/8	60	3/4	19
WJ-265-5/16	5/16	2 3/8	60	3/4	19
WJ-265-7/16	7/16	2 3/8	60	1	25
WJ-265-3/8	3/8	2 3/8	60	1	25
WJ-265-17/32	17/32	2 3/8	60	1 1/8	29
WJ-265-1/2	1/2	2 3/8	60	1 1/8	29

#5 (1 5/8") Spline Drive



SAE Hex Opening Sockets

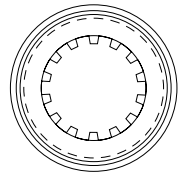

Part Number	Single Hex Opening		Overall Length		Diameter Nose End		Bolt Clearance	
	In.	In.	mm	In.	mm	In.	mm	
SPL-132	1	3 1/4	82	1 3/4	45	1 1/2	38	
SPL-134	1 1/16	3 1/4	82	1 7/8	48	1 5/8	41	
SPL-136	1 1/8	3 1/4	82	2	51	1 5/8	41	
SPL-138	1 3/16	3 1/4	82	2 3/8	60	1 5/8	41	
SPL-140	1 1/4	3 1/4	82	2 3/8	60	1 3/4	45	
SPL-142	1 5/16	3 1/4	82	2 3/8	60	1 3/4	45	
SPL-144	1 3/8	3 1/4	82	2 3/8	60	1 3/4	45	
SPL-146	1 7/16	3 1/4	82	2 3/8	60	1 3/4	45	
SPL-148	1 1/2	3 3/8	86	2 3/8	60	1 1/2	38	
SPL-150	1 9/16	3 3/8	86	2 5/8	67	1 5/8	41	
SPL-152	1 5/8	3 3/8	86	2 5/8	67	1 5/8	41	
SPL-154	1 11/16	3 1/2	89	2 5/8	67	1 3/4	45	
SPL-156	1 3/4	3 1/2	89	2 7/8	73	1 3/4	45	
SPL-158	1 13/16	3 1/2	89	3	76	1 3/4	45	
SPL-160	1 7/8	3 1/2	89	3	76	1 7/8	48	
SPL-162	1 15/16	3 5/8	92	3 1/4	83	2	51	
SPL-166	2 1/16	3 5/8	92	3 1/4	83	2	51	
SPL-168	2 1/8	3 5/8	92	3 1/4	83	2	51	
SPL-170	2 3/16	3 5/8	92	3 1/4	83	2	51	
SPL-174	2 5/16	4	102	3 1/2	89	2 1/8	54	
SPL-176	2 3/8	4	102	3 3/4	95	2 1/4	57	
SPL-178	2 7/16	4	102	3 1/2	89	2 1/4	57	
SPL-180	2 1/2	4	102	3 3/4	95	2 1/4	57	
SPL-182	2 9/16	4	102	3 3/4	95	2 1/4	57	
SPL-184	2 5/8	4	102	4	102	2 1/4	57	
SPL-186	2 11/16	4	102	4	102	2 3/8	60	
SPL-188	2 3/4	4 1/4	108	4 1/4	108	2 3/8	60	

Extensions



Part Number	Overall Length		
	In.	mm	
EXL-8	8	203	Female spline to male spline
EXL-15	15	381	Female spline to male spline

Adapters



Part Number	
EXL-750	Female spline to 3/4" male square
EXL-1000	Female spline to 1" male square
EXL-1100	Female spline to 1 1/2" male square

#5 (1 5/8") Spline Drive



Universal Wrenches



Part Number	
MFL-250	Female spline to male spline (heavy duty)
MFL-1000	Female spline to 1" male square

Universal wrenches must not be used with impact drivers. Maximum operating angle is 30°.

#5 (1 5/8") Spline Drive Budd Wheel Sockets

Combo. 13/16" Square 1 1/2" Hex



Part Number	Drive	Overall Length	
		In.	mm
HT-848	#5 Spline	4 1/4	108

Socket Retaining Rings

Plastic Retaining Ring With Steel Insert



Part Number	Drive	Inside Diameter	
		In.	mm
10005S	3/4" Square	1 1/4	31.8
10032S	3/4" Square	1 7/16	36.5
10034S	3/4" Square	1 5/8	41.3
10008S	1" Square	1 3/4	44.5
10010S	1" Square	2	50.8
10015S	1" Square	2 1/8	54.0
10016S	1" Square	2 1/4	57.2
10017S	1" Square	2 1/2	63.5
10019S	1" Square	2 5/8	66.7
10020S	1 1/2" Square	2 7/8	73.0
10025S	1 1/2" Square	3 3/8	85.7
10030S	1 1/2" Square	3 7/8	98.4
10035S	1 1/2" Square	4 3/8	111.1

Metal Retaining Ring



Part Number	Drive	Inside Diameter	
		In.	mm
MET-1301C	3/8" Square	.677	17.2
MET-1302C	3/8" Square	.771	19.6
MET-1401C	1/2" Square	.885	22.5
MET-1402C	1/2" Square	1.086	27.6
MET-1600C	3/4" Square	1.594	40.5
MET-1800C	1" Square	1.948	49.5

Adapters



#130-A Yankee Drive for Spiral Type Driver



Part Number	Male Square In.	Overall Length		Shank Diameter	
		In.	mm	In.	mm
YK-250	1/4	1 15/16	49	.277	7.0
YK-370	3/8	2 3/16	56	.277	7.0
YK-500	1/2	2 5/16	59	.277	7.0

#131-A Yankee Drive for Spiral Type Driver



Part Number	Male Square In.	Overall Length		Shank Diameter	
		In.	mm	In.	mm
YK-251	1/4	1 15/16	49	.310	8.0
YK-371	3/8	2 3/16	56	.310	8.0
YK-501	1/2	2 5/16	59	.310	8.0

#135-A Yankee Drive for Spiral Type Driver



Part Number	Male Square In.	Overall Length		Shank Diameter	
		In.	mm	In.	mm
YK-252	1/4	1 15/16	49	.215	5.5
YK-372	3/8	2 3/16	56	.215	5.5
YK-502	1/2	2 5/16	59	.215	5.5

Female Threaded Adapters



Part Number	Female Thread	Male Square In.	Type of Lock
TH-257	3/8"-24	1/4	Pin
TH-377	3/8"-24	3/8	Pin
TH-501	3/8"-24	1/2	Pin
TH-378	1/2"-20	3/8	Pin
TH-502	1/2"-20	1/2	Pin

Male Threaded Adapters



Part Number	Male Thread	Hex Drive
TM-24	3/8"-24	1/4
TN-24	3/8"-24	7/16
TM-20	1/2"-20	1/4
TN-20	1/2"-20	7/16

Adapters



Socket and Ratchet Wrench Adapters, SAE



Part Number	Male Square In.	Male Hex In.	Overall Length In.
A-108	1/4	1/4	25/32
A-110	1/4	5/16	25/32
A-112	1/4	3/8	25/32
A-114	1/4	7/16	25/32
A-116	1/4	1/2	25/32
A-118	1/4	9/16	25/32
A-120	1/4	5/8	25/32
A-312	3/8	3/8	1 1/64
A-314	3/8	7/16	1 1/64
A-316	3/8	1/2	1 5/64
A-318	3/8	9/16	1 5/64
A-320	3/8	5/8	1 5/64
A-322	3/8	11/16	1 5/64
A-324	3/8	3/4	1 5/64
A-326	3/8	13/16	1 5/64
A-328	3/8	7/8	1 5/64
A-512	1/2	3/8	1 3/32
A-514	1/2	7/16	1 3/32
A-516	1/2	1/2	1 3/32
A-518	1/2	9/16	1 3/32
A-520	1/2	5/8	1 1/8
A-522	1/2	11/16	1 1/8
A-524	1/2	3/4	1 1/8

(Continued on next page.)

Socket and Ratchet Wrench Adapters, SAE (continued)



Part Number	Male Square In.	Male Hex In.	Overall Length In.
A-526	1/2	13/16	1 1/8
A-528	1/2	7/8	1 1/8
A-530	1/2	15/16	1 1/8
A-532	1/2	1	1 1/8
A-534	1/2	1 1/16	1 1/8
A-536	1/2	1 1/8	1 1/8
A-538	1/2	1 3/16	1 1/8
A-540	1/2	1 1/4	1 1/8

Socket and Ratchet Wrench Adapters, Metric



Part Number	Male Square In.	Male Hex mm	Overall Length	
			In.	mm
A-1-6mm	1/4	6	25/32	20
A-1-7mm	1/4	7	25/32	20
A-1-8mm	1/4	8	25/32	20
A-1-9mm	1/4	9	25/32	20
A-1-10mm	1/4	10	25/32	20
A-1-11mm	1/4	11	25/32	20
A-1-12mm	1/4	12	25/32	20
A-1-13mm	1/4	13	25/32	20
A-3-10mm	3/8	10	15/16	24
A-3-11mm	3/8	11	15/16	24
A-3-12mm	3/8	12	15/16	24
A-3-13mm	3/8	13	15/16	24
A-3-14mm	3/8	14	15/16	24
A-3-15mm	3/8	15	15/16	24
A-3-16mm	3/8	16	15/16	24
A-3-17mm	3/8	17	15/16	24
A-3-18mm	3/8	18	15/16	24
A-3-19mm	3/8	19	15/16	24
A-5-10mm	1/2	10	1 1/8	29
A-5-11mm	1/2	11	1 1/8	29
A-5-12mm	1/2	12	1 1/8	29
A-5-13mm	1/2	13	1 1/8	29
A-5-14mm	1/2	14	1 1/8	29
A-5-15mm	1/2	15	1 1/8	29
A-5-16mm	1/2	16	1 1/8	29
A-5-17mm	1/2	17	1 1/8	29
A-5-18mm	1/2	18	1 1/8	29
A-5-19mm	1/2	19	1 1/8	29
A-5-20mm	1/2	20	1 1/8	29
A-5-21mm	1/2	21	1 1/8	29
A-5-22mm	1/2	22	1 1/8	29
A-5-23mm	1/2	23	1 1/8	29
A-5-24mm	1/2	24	1 1/8	29
A-5-25mm	1/2	25	1 1/8	29

Refer to Page iv for description of Rapid Select.

Adapters



Sockets with Male Hex



Part Number	Female Hex In.	Male Hex In.	Overall Length	
			In.	mm
SJ-375	5/16	3/8	13/16	21
SJ-378	7/16	3/8	15/16	24
SJ-379	1/2	3/8	1	25
SJ-380	9/16	3/8	1	25
SJ-349	3/8	7/16	15/16	24
SJ-350	7/16	7/16	15/16	24
SJ-351	1/2	7/16	1	25
SJ-352	9/16	7/16	1	25
SJ-360	3/8	1/2	15/16	24
SJ-361	7/16	1/2	15/16	24
SJ-241	1/2	1/2	1	25
SJ-362	9/16	1/2	1	25
SJ-363	5/8	1/2	1 1/8	28
SJ-364	11/16	1/2	1 3/16	30
SJ-365	3/4	1/2	1 3/16	30
SJ-55	7/16	9/16	15/16	24
SJ-66	1/2	9/16	1	25
SJ-67	9/16	9/16	1	25
SJ-68	5/8	9/16	1 1/8	28

Hex Drive Universal Adapters

Male Hex to Male Square – Extension



(Tension Type Shown)

Part Number Standard	Tension	Male Sq. In.	Male Hex In.	Type of Lock	Overall Length		Largest Diameter	
					In.	mm	In.	mm
KCM-25-3	KSM-25-3	1/4	1/4	Pin	3	76	5/8	15.9
KCM-25-B-6	KSM-25-B-6	1/4	1/4	Ball	6	152	5/8	15.9
KCM-37-6	KSM-37-6	3/8	1/4	Pin	6	152	3/4	19.1
KCM-37-B-6	KSM-37-B-6	3/8	1/4	Ball	6	152	3/4	19.1
KEM-37-B-6	-	3/8	5/16	Ball	6	152	7/8	22.2
KBM-37-6	KTM-37-6	3/8	7/16	Pin	6	152	3/4	19.1

Universal wrenches must not be used with impact drivers. Maximum operating angle is 30°. Standard lengths are 3", 6", 9" and 12" (76, 152, 229 and 305mm).

Part Number Index

Part No.	Page No.	Part No.	Page No.	Part No.	Page No.	Part No.	Page No.	Part No.	Page No.	Part No.	Page No.	Part No.	Page No.	Part No.	Page No.	Part No.	Page No.
400-BH	54	1208*	77	3222	87	5119	105	5416*	106	6124	128	7158	133	7540	135	8342*	142
401	6	1209	77	3224	87	5120*	105	5418*	106	6126	128	7160	133	7542	135	8344	142
402*	6	1210*	77	3226	87	5121	105	5420*	106	6128	128	7162	133	7544	135	8346	142
403	6	1211	77	3228	87	5122*	105	5421	106	6130	128	7164	133	7546	135	8348	142
440	54	1212*	77	3308	87	5124*	105	5422	106	6132	128	7166	133	7548	135	8350	142
450	54	1213	77	3310	87	5125	105	5424*	106	6134	128	7168	133	7552	135	8352	142
451	6	1214*	77	3311	87	5126*	105	5426*	106	6136	128	7170	133	7556	135	8354	142
452	6	1215	77	3312*	87	5128*	105	5428*	106	6138	128	7172	133	7564	135	8356	142
453	6	1216	77	3314*	87	5129	105	5430*	106	6140	128	7174	133	7620	136	8358	142
454	6	1217	77	3316*	87	5130*	105	5432	106	6142	128	7176	133	7622	136	8360	142
460	58	1218	77	3318*	87	5131	105	5434	106	6144	128	7180	133	7624	136	8362	142
470	58	1220	8	3320*	87	5132*	105	5436*	106	6146	128	7320	135	7626	136	8364	142
480	54	1308	78	3322	87	5134*	105	5438	106	6148*	128	7322	135	7628	136	8366	142
482	5	1310*	78	3324*	87	5136*	105	5440*	106	6320	129	7324SKT	135	7630	136	8368	142
483*	5	1311	78	3326	87	5138	105	5442	106	6322	129	7326	135	7632	136	8370	142
484	5	1312	78	3328	87	5140*	105	5510	108	6324*	129	7328	135	7636*	136	8372	142
488	54	1313	78	3408	87	5142*	105	5512*	108	6326	129	7330*	135	8124	140	8374	142
490*	52	1314	78	3409	87	5144	105	5514*	108	6328	129	7332	135	8126	140	8376	142
491*	4	1316	78	3410*	87	5146	105	5516*	108	6330	129	7334	135	8128	140	8380	142
492*	4	1318	78	3411	87	5148*	105	5518*	108	6332	129	7336	135	8130	140	8382	142
493*	4	1320	78	3412*	87	5150	105	5520*	108	6334	129	7338	135	8132	140	8384	142
494	4	1608	80	3414*	87	5152*	105	5522*	108	6336	129	7340	135	8134	140	8386	142
498	53	1609	80	3416*	87	5154	105	5524*	108	6338	129	7342	135	8136	140	8388	142
501	6	1610	80	3418*	87	5156	105	5526*	108	6340	129	7344	135	8138	140	8390	142
502*	6	1611	80	3420	87	5210	107	5528*	108	6342	129	7346	135	8140	140	8430	141
503	6	1612	80	3422	87	5212	107	5530*	108	6344	129	7348*	135	8142	140	8432	141
551	6	1614	80	3424	87	5214	107	5532*	108	6346	129	7350	135	8144	140	8434	141
552*	6	2122	42	3426	87	5216*	107	5534*	108	6348	129	7352	135	8146	140	8436	141
553	6	2123	42	3428	87	5218*	107	5608	111	6352	129	7354	135	8148	140	8438	141
591	7	2124	42	3430	87	5220*	107	5609	111	6414	128	7356	135	8152	140	8440	141
592*	7	2125	42	3432	87	5222	107	5610	111	6418	128	7358	135	8154	140	8442	141
610	53	3010	94	3434	87	5224*	107	5612*	111	6420	128	7360	135	8158	140	8444	141
630	53	3012	86	3510*	88	5226	107	5614	111	6424	128	7362	135	8160	140	8446	141
638	53	3014*	86	3511	88	5228	107	5616*	111	6426	128	7364	135	8162	140	8448	141
820	55	3016*	86	3512*	88	5230*	107	5618	111	6428	128	7372	135	8164	140	8452	141
821	7	3018*	86	3513	88	5232	107	5620	111	6430	128	7376	135	8166	140	8456	141
822	7	3020	86	3514*	88	5234	107	5622	111	6432	128	7424*	134	8168	140	8458	141
825*	55	3022	86	3516*	88	5236*	107	5624	111	6436	128	7426	134	8170	140	8460	141
830*	55	3024*	86	3518*	88	5238	107	5626	111	6440	128	7428	134	8172	140	8464	141
832*	7	3026	86	3522	88	5240	107	5628	111	6444	128	7430*	134	8174	140	8468	141
833*	7	3028	86	3524	88	5242	107	5632	111	6520	129	7432	134	8176	140	8472	141
834	7	3108*	86	3530	88	5244	107	5634	111	6522	129	7434	134	8178	140	8480	141
835*	55	3109	86	3532	88	5246	107	5636	111	6524	129	7436*	134	8180	140	8528	142
838*	13	3110*	86	3534	88	5248	107	5712	112	6526	129	7438	134	8182	140	8530	142
850	55	3111	86	3607	92	5310	107	5714	112	6528	129	7440	134	8184	140	8534	142
852	7	3112*	86	3608	92	5312	107	5716	112	6530	129	7442	134	8186	140	8536	142
853	7	3113	86	3609	92	5314*	107	5718	112	7116	133	7444	134	8188	140	8540	142
854*	7	3114*	86	3610*	92	5316*	107	5720	112	7118	133	7446	134	8190	140	8542	142
855*	55	3115	86	3612*	92	5318*	107	5724	112	7120	133	7448	134	8226	141	8548	142
858*	13	3116*	86	3614	92	5320*	107	5728	112	7122	133	7450	134	8228	141	8620	143
1105	77	3117	86	3618	92	5322*	107	5732	112	7124	133	7452	134	8230	141	8624	143
1106	77	3118*	86	3620	92	5324*	107	5812	112	7126	133	7454	134	8232	141	8626	143
1107	77	3119	86	3622	92	5326*	107	5818	112	7128	133	7456	134	8236	141	8628	143
1108*	77	3120*	86	3624	92	5328*	107	5820	112	7130	133	7458	134	8240	141	8630	143
1109*	77	3121	86	4910*	4	5330*	107	5822	112	7132	133	7460	134	8242	141	8632	143
1110*	77	3122	86	4930	4	5332*	107	5832	112	7134	133	7464	134	8244	141	8634	143
1111*	77	3124*	86	5108	105	5334*	107	5836	112	7136	133	7466	134	8246	141	8636	143
1112*	77	3126	86	5109	105	5336*	107	5910	112	7138	133	7470	134	8248	141	8638	143
1113	77	3208	87	5110*	105	5338	107	5912	112	7140	133	7472	134	8324	142	8640	143
1114*	77	3209	87	5111	105	5340*	107	5914	112	7142	133	7524*	135	8326	142	8642	143
1115	77	3210*	87	5112*	105	5342*	107	5916	112	7144	133	7526	135	8328	142	8644	143
1116*	77	3211	87	5113	105	5344	107	5918	112	7146	133	7528*	135	8330	142	8646	143
1118*	77	3212*	87	5114*	105	5346	107	5920	112	7148*	133	7530*	135	8332	142	8648	143
1119	77	3214*	87	5115	105	5348*	107	6116	128	7150	133	7532	135	8334	142	8650	143
1120	77	3216*	87	5116*	105	5410	106	6118	128	7152	133	7534	135	8336	142	8652	143
1206	77	3218*	87	5117	105	5412	106	6120	128	7154	133	7536*	135	8338	142	8654	143
1207	77	3220*	87	5118*	105	5414	106	6122	128	7156	133	7538	135	8340	142	8656	143

*Denotes a Rapid Select item. Refer to Page iv for description of Rapid Select.

Part No.	Page No.	Part No.	Page No.	Part No.	Page No.	Part No.	Page No.	Part No.	Page No.	Part No.	Page No.	Part No.	Page No.	Part No.	Page No.	Part No.	Page No.
8658	143	10MM11*	81	12MM03-D	95	13-TX-40	58	16MM35-D	117	185-3MM*	33	19MM55	118	21MM38	144	260-7	15
8660	143	10MM11-D	81	12MM11*	81	14MM03	95	16MM43	96	185-4*	33	19MM55-D	118	21MM45	116	260-8	15
8662	143	10MM13*	95	12MM11-D	81	14MM03-D	95	16MM43-D	96	185-4-4	33	1E06	79	21MM45-D	116	260-9	15
9140	147	10MM13-D*	95	12MM13*	95	14MM11	81	16MM45	116	185-4MM*	33	1E07	79	21MM55	118	265-0	44
9142	147	10MM15*	116	12MM13-D	95	14MM11-D	81	16MM45-D	116	185-5	33	1E08	79	21MM57	137	265-1	44
9144	147	10MM15-D	116	12MM15*	116	14MM13*	95	16MM55*	118	185-5MM*	33	1E09	79	21-S-156-0375	55	265-1/4	45
9146	147	10MM21*	78	12MM15-D*	116	14MM13-D	95	16MM55-D	116	185-6	33	1E10	79	21-S-156-0750	55	265-10	44
9148	147	10MM21-D	78	12MM21	81	14MM15*	116	170-0	44	185-6MM	33	1E11	79	21-S-156-0937	55	265-2	44
9150	147	10MM23*	96	12MM21-D	81	14MM15-D*	116	170-1	44	185-7	33	1E12	79	21-S-187-1125	55	265-3	44
9152	147	10MM23-D	96	12MM23*	96	14MM21	95	170-1/2	45	185-7MM	33	1E14	79	21-S-187-1375	55	265-3/8	45
9154	147	10MM25	117	12MM23-D	96	14MM23*	96	170-1/4*	45	185-8	33	1E15	79	21-S-187-1500	55	265-4	44
9156	147	10MM25-D	117	12MM25	117	14MM23-D	96	170-1/4A	45	185-8MM	33	1P06	80	21-S-187-1625	55	265-5	44
9158	147	10MM33*	96	12MM25-D	117	14MM25*	117	170-1/4-ACR	45	185-9*	33	1P07	80	22MM03	95	265-5/16	45
9162	147	10MM35	117	12MM35	117	14MM35	117	170-1/4B*	44	185-9MM	33	1P08	80	22MM13	95	265-6	44
9164	147	10MM35-D	117	12MM35-D	117	14MM35-D	117	170-10*	44	18MM03	95	1P09	80	22MM15*	116	265-7/16	45
9166	147	10MM43*	96	12MM43*	96	14MM43	96	170-10A	45	18MM03-D	95	1P10	80	22MM15-D	116	265-8	44
9168	147	10MM43-D	96	12MM43-D	96	14MM43-D	96	170-10-ACR*	44	18MM13*	95	1P11	80	22MM16	131	265A-0	44
9170	147	10MM45	116	12MM45	116	14MM45*	116	170-2	44	18MM13-D	95	1P12	80	22MM17	137	265A-1	44
9172	147	10MM45-D	116	12MM45-D	116	14MM45-D	116	170-3	44	18MM15*	116	1P14	80	22MM18	144	265A-1/4	45
9174	147	10MM55	118	12MM55	118	14MM55	116	170-3/8	45	18MM15-D	116	1P16	80	22MM23	96	265A-10	44
9176	147	10MM55-D	118	12MM55-D	118	14MM55-D	116	170-3/8A	45	18MM16	131	20MM03	95	22MM25*	117	265A-2	44
9178	147	10MME1*	83	12MME1	83	1500-P*	57	170-3/8B	44	18MM17*	137	20MM13	95	22MM25-D	117	265A-3	44
9180	147	10MME3	99	12MME3	99	1505-P	57	170-3/8C	45	18MM23*	96	20MM15	116	22MM35	117	265A-3/8	45
9182	147	1106-D	77	130-3	15	1510-P	57	170-4*	44	18MM23-D	96	20MM15-D	116	22MM35-D	117	265A-4	44
9184	147	1107-D	77	130-4	15	1550-P	57	170-5*	44	18MM25*	117	20MM16	131	22MM36	131	265A-5	44
9186	147	1108-D*	77	130-5	15	1555-P	57	170-5/16	45	18MM25-D*	117	20MM17	136	22MM37	137	265A-5/16	45
9190	147	1109-D	77	130-6	15	15MM03*	95	170-5/16A	45	18MM35*	117	20MM23	96	22MM45	116	265A-6	44
9192	147	1110-D*	77	130-7	15	15MM03-D	95	170-5/16-ACR	45	18MM35-D	117	20MM23-D	96	22MM45-D	116	265A-7/16	45
9194	147	1111-D	77	130-8	15	15MM11	81	170-5/16B*	44	18MM36	131	20MM25	117	22MM47	137	265A-8	44
9196	147	1112-D	77	1308-D	78	15MM11-D	81	170-5/8	45	18MM43	96	20MM25-D	117	22MM55	118	268P-0	59
9198	147	1113-D	77	1310-D	78	15MM13*	95	170-5/8D	45	18MM43-D	96	20MM35	117	22MM55-D	118	268P-1	59
91100	147	1114-D	77	1312-D	78	15MM13-D	95	170-6*	44	18MM45*	116	20MM35-D	117	22MM57	137	268P-2	59
91102	147	1116-D	77	1313-D	78	15MM15*	116	170-6-ACR	44	18MM45-D	116	20MM45	116	23MM15	116	268P-3	59
91104	147	1117-D	77	1314-D	78	15MM15-D	116	170-7/16	45	18MM55*	118	20MM55	118	23MM15-D	116	268P-4	59
91106	147	1118-D	77	1316-D	78	15MM16	131	170-7/16C	45	18MM55-D	118	212-0	43	23MM16	131	268P-5	59
91108	147	1119-D	77	1320-D	78	15MM21	81	170-8*	44	190-1	42	212-1	43	23MM17	137	268P-6	59
91110	147	1120-D	77	13MM03*	95	15MM21-D	81	170-8A	45	190-3	42	212-1/4*	43	23MM18	144	268P-8	59
91112	147	11MM03	95	13MM03-D	95	15MM23*	95	170-8-ACR	44	190-4	42	212-1/4A*	43	23MM25	117	268P-10	59
91116	147	11MM03-D	95	13MM11*	81	15MM23-D	96	170-9/16	45	190-5	42	212-1/4A-ACR	43	23MM25-D	117	268P-1/4	59
91120	147	11MM11*	81	13MM11-D	81	15MM25*	117	17MM03	95	190-7	42	212-1/4-ACR	43	23MM35	117	268P-15	116
91124	147	11MM11-D	81	13MM13*	95	15MM25-D	117	17MM03-D	95	1950-0	41	212-10*	43	23MM37	137	268P-15-D	116
91128	147	11MM13*	95	13MM13-D	95	15MM33*	96	17MM13*	95	1950-1	41	212-10A	43	23MM38	144	268P-17	137
91132	147	11MM13-D	95	13MM15*	116	15MM33-D	96	17MM13-D	95	1950-2*	41	212-10-ACR*	43	23MM55	118	268P-18	144
91136	147	11MM15	116	13MM15-D	116	15MM35*	117	17MM15*	116	1950-3	41	212-2*	43	24BITKIT	57	268P-25	117
91140	147	11MM15-D	116	13MM21*	81	15MM35-D	117	17MM15-D	116	1951-0	41	212-3*	43	24MM15*	116	268P-37	137
91144	147	11MM21	81	13MM21-D	81	15MM36	131	17MM16	131	1951-1	41	212-3/8A	43	24MM15-D	116	268P-55	118
91152	147	11MM21-D	81	13MM23*	96	15MM43	96	17MM17	137	1951-2*	41	2123-A	42	24MM16	131	273-0	44
10005S	156	11MM23*	96	13MM23-D	96	15MM43-D	96	17MM23*	96	1951-3	41	2123-B	42	24MM17	137	273-1	44
10008S	156	11MM23-D	96	13MM25*	117	15MM45*	116	17MM23-D	96	1953-0	41	212-4*	43	24MM18	144	273-10*	44
10010S	156	11MM25	117	13MM25-D*	117	15MM45-D	116	17MM25*	117	1953-1	41	212-5*	43	24MM25*	117	273-2	44
10015S	156	11MM25-D	117	13MM33*	96	15MM55*	118	17MM25-D	117	1953-2*	41	212-5/16A*	43	24MM25-D	117	273-3	44
10016S	156	11MM35	117	13MM35*	117	15MM55-D	118	17MM35*	117	1953-3*	41	212-5/16A-ACR	43	24MM35*	117	273-4	44
10017S	156	11MM35-D	117	13MM35-D	117	1608-D	80	17MM35-D	117	19MM03	95	212-6*	43	24MM35-D	117	273-5	44
10019S	156	11MM43	96	13MM43*	96	1609-D	80	17MM36	131	19MM03-D	95	212-6-ACR	43	24MM36	131	273-6	44
10020S	156	11MM43-D	96	13MM43-D	96	1610-D	80	17MM43	96	19MM13	95	212-8*	43	24MM37*	137	273-8*	44
10025S	156	11MM45	116	13MM45*	116	1612-D	80	17MM43-D	96	19MM13-D	95	212-8A	43	24MM38	144	273A-0	44
10030S	156	11MM45-D	116	13MM45-D	116	1614-D	80	17MM45*	116	19MM15*	116	212-8-ACR*	43	24MM47*	137	273A-1	44
10032S	156	11MM55	118	13MM55*	118	16MM03	95	17MM45-D	116	19MM15-D	116	21MM03	95	24MM55	118	273A-10	44
10034S	156	11MME1	83	13MM55-D*	118	16MM03-D	95	17MM55*	118	19MM16	131	21MM13	95	24MM55-D	118	273A-2	44
10035S	156	11MME3	99	13MME1	83	16MM11	81	17MM55-D	118	19MM17	137	21MM15*	116	24MM57*	137	273A-3	44
103-0	14	1206-D	77	13MME5	121	16MM13*	95	185-0	33	19MM23	96	21MM15-D	116	25MM15	116	273A-4	44
103-00	14	1207-D	77	13-TX-06	58	16MM13-D	95	185-00	33	19MM23-D	96	21MM16	131	25MM15-D	116	273A-6	44
103-000	14	1208-D	77	13-TX-07	58	16MM15*	116	185-000*	33	19MM25*	117	21MM17*	137	25MM17	137	273A-8	44
103-1	14	1209-D	77	13-TX-08*	58	16MM15-D	116	185-1*	33	19MM25-D	117	21MM18	144	25MM18	144	273B-0	44
103-2	14	1210-D	77	13-TX-09	58	16MM16	131	185-1.5MM	33	19MM35*	117	21MM23	96	25MM35	117	273B-1	44
103-3	14	1211-D	77	13-TX-10*	58	16MM21	81	185-10*	33	19MM35-D	117	21MM25*	117	25MM37	137	273B-10	44
103-4	14	1212-D	77	13-TX-15*	58	16MM23	96	185-10MM	33	19MM36	131	21MM25-D	117	260-1	15	273B-2	44
103-5	14	1214-D	77	13-TX-20	58	16MM23-D	96	185-2*	33	19MM43	96	21MM35*	117	260-2	15	273B-3	44
103-6	14	1216-D	77	13-TX-25	58	16MM25*	117	185-2.5MM	33	19MM43-D	96	21MM35-D	117	260-3	15	273B-4	44
10MM03*	95	1218-D	77	13-TX-27	58	16MM25-D	117	185-2MM	33	19MM45	116	21MM36	131	260-4	15	273B-5	44
10MM03-D*	95	12MM03*	95	13-TX-30	58	16MM35	117	185-3*	33	19MM45-D	116	21MM37	137	260-5	15	273B-6	44

*Denotes a Rapid Select item. Refer to Page iv for description of Rapid Select.

Part No.	Page No.	Part No.	Page No.	Part No.	Page No.	Part No.	Page No.	Part No.	Page No.	Part No.	Page No.	Part No.	Page No.	Part No.	Page No.	Part No.	Page No.
273B-8*	44	3122-D	86	324-3	13	3324-D	87	3P11	92	440-F	30	446-22T*	2	48-TSQ-12M	49	492-SF	29
27MM15*	116	3124-D	86	324-4	13	3326-D	87	3P12	92	440-TSQ-10M	49	446-23T	1	48-TSQ-14M	49	4930-A	4
27MM15-D	116	315-10MM	34	324-5	13	3328-D	87	3P14	92	440-TSQ-4M	49	446-27	2	48-TSQ-4M	49	4930-B	4
27MM17	137	315-12MM	34	324-6	13	33MM15	196	3P16	92	440-TSQ-5M	49	446-2-ACR2-D	2	48-TSQ-5M	49	4930-C	4
27MM18	144	315-14MM	34	325-0	12	33MM17	137	3P18	92	440-TSQ-6M	49	446-2-PZD*	26	48-TSQ-6M	49	4930-CC	4
27MM25	117	315-2.5MM	34	325-0	12	33MM18	144	4.5MM11	81	440-TSQ-8M	49	446-2-SF	29	48-TSQ-8M	49	49-30IP	25
27MM37	137	315-3	33	325-00	12	33MM37	138	4.5MME1	83	440-TX-05	19	446-F	30	48-TX-40	22	493-A*	4
27MM38	144	315-3MM	34	325-000	12	33MM38	144	401-PZD	27	440-TX-06	19	46MM17	137	48-TX-45	22	493-ACR3*	5
27MM47	137	315-4	33	325-1	13	3408-D	87	402-PZD	27	440-TX-07	19	46MM18	144	48-TX-50*	22	493-ACR3-D	5
27MM55	118	315-4MM	34	325-2	13	3410-D	87	403-PZD	27	440-TX-07-H	19	46MM38	144	48-TX-55	22	493-ACR3-R	5
27MM55-D	118	315-5	33	325-20	13	3412-D*	87	41MM17	137	440-TX-08	19	47MM18	144	490-10	50	493-AF	30
27MM57	138	315-5MM	34	325-3	13	3414-D	87	41MM18	144	440-TX-08-H	19	47MM38	144	490-3	50	493-A-PZD	27
28MM15	116	315-6	33	325-4	13	3416-D	87	41MM37	138	440-TX-09	19	480-1	1	490-4*	50	493-A-SF	29
28MM15-D	116	315-6MM	34	325-5	13	3418-D	87	41MM38	144	440-TX-09-H	19	480-1-PZD	26	490-5	50	493-B*	4
28MM17	137	315-7	33	325-6	13	3420-D	87	42MM18	144	440-TX-10	19	480-2*	3	490-6	50	493-BF	30
28MM18	144	315-7MM	34	326-0	12	3422-D	87	440-1*	1	440-TX-10-H	19	480-22	3	490-8	50	493-B-SF	29
28MM25	117	315-8	33	326-00	12	3424-D	87	440-10IP	25	440-TX-10-W	19	480-225	3	4910-A	4	493-C*	4
28MM37	138	315-8MM	34	326-000	12	3426-D	87	440-115	1	440-TX-15	19	480-24	3	4910-B*	4	493-CF	30
28MM38	144	315-9MM	34	326-1	12	3428-D	87	440-12	1	440-TX-15-125	19	480-27	3	4910-C	4	493-C-SF	29
29MM15	115	320-0	12	326-2	13	3430-D	87	440-125	1	440-TX-15-H	19	480-2-ACR2*	3	49-10IP	25	493-F	30
29MM15-D	115	320-00	12	326-20	13	3432-D	87	440-125-PZD	26	440-TX-15-W	19	480-2-ACR2-D	3	49-15IP	25	493-PZD	27
29MM17	137	320-000	12	326-3	13	3434-D	87	440-13	1	440-TX-20	19	480-2-ACR2-R	3	491-A*	4	493-SF	29
29MM18	144	320-1*	12	326-4	13	34MM15	116	440-15IP	25	440-TX-20	19	480-2-PZD	26	491-ACR1	5	49-40IP	25
29MM25	117	320-2*	13	326-5	13	34MM17	137	440-1-ACR1	2	440-TX-20-2	19	480-2-SF	29	491-ACR1-D	5	49-A-10IP	25
29MM25-D	117	320-20	13	326-6	13	34MM18	144	440-1-ACR1-D	2	440-TX-20-H	19	480-3*	3	491-ACR1-R	5	49-A-15IP	25
29MM37	138	320-20	13	327-0	12	34MM37	138	440-1-ACR1-R	2	440-TX-20-W	19	480-325	3	491-AF	30	49-A-20IP	25
29MM38	144	320-3*	13	327-0	12	3512-D	88	440-1-PZD	26	440-TX-25	19	480-3-ACR3	3	491-A-PZD	27	49-A-25IP	25
29MM55	118	320-4*	13	327-00	12	3514-D*	88	440-1-SF	29	440-TX-25-H	19	480-3-ACR3-D	3	491-A-SF	29	49-A-27IP	25
3.5MM11	81	320-5*	13	327-000	12	3516-D	8	440-2*	1	440-TX-25-W	19	480-3-ACR3-R	3	491-B*	4	49-A-30IP	25
3.5MME1	83	320-5	13	327-1	12	3518-D	88	440-20IP	25	440-TX-27	19	480-3-PZD	26	491-BF	30	49-A-40IP	25
3012-D	85	320-6	13	327-2	12	3522-D	88	440-215*	1	440-TX-27-H	19	480-3-PZD	26	491-B-PZD	27	49-A-TX-05	21
3014-D*	85	3209-D	87	327-20	12	3524-D	88	440-215-PZD	26	440-TX-27-W	19	480-3-SF	29	491-B-SF	29	49-A-TX-06	21
3016-D	86	320-L*	17	327-3	12	3530-D	88	440-215-SF	29	440-TX-30	19	480-4*	3	491-C*	4	49-A-TX-07	21
3018-D	86	320-M*	17	327-4	12	3532-D	88	440-22	1	440-TX-30-H	19	480-4-ACR4	3	491-CC*	4	49-A-TX-08*	21
3020-D	86	320-P*	17	327-5	13	35MM15	116	440-225*	1	440-TX-30-W	19	480-4-ACR4-R	3	491-CF	30	49-A-TX-09	21
3022-D	86	320-R*	17	327-6	13	35MM17	137	440-225-PZD	26	440-TX-40	19	480-4BN*	3	491-C-SF	29	49-A-TX-10*	21
3024-D	86	320-S	17	328-0	12	35MM18	144	440-225-SF	29	440-TX-40-H	19	480-4BN-PZD	26	491-F	30	49-A-TX-10-H	22
3026-D	86	320-T*	17	328-0	12	35MM37	138	440-22-ACR2	2	440-TX-40-W	19	480-4BN-SF	29	491-PZD	27	49-A-TX-15*	21
309-0	15	3210-D	87	328-00	12	35MM38	144	440-22-ACR2-D	2	440-TX-45	19	480-4-PZD	26	491-SF	29	49-A-TX-15-H	22
309-00	15	3211-D	87	328-000	12	3608-D	92	440-22-ACR2-R	2	440-TX-50	19	480-4-SF	29	49-20IP	25	49-A-TX-15-W	22
309-000	15	3212-D	87	328-1	13	3609-D	92	440-22-PZD	26	445-0	11	480-F	30	492-200MM	4	49-A-TX-20*	21
309-1	15	3214-D	87	328-2	13	3610-D	92	440-22-SF	29	445-00	11	480-TSQ-10M	49	492-27	4	49-A-TX-20-H	22
309-2	15	3216-D	87	328-2	13	3612-D	92	440-23	1	445-000	11	480-TSQ-12M	49	49-25IP	25	49-A-TX-25*	21
309-3	15	3218-D	87	328-20	13	3614-D	92	440-24	1	445-00-15	11	480-TSQ-14M	49	49-27IP	25	49-A-TX-27	21
309-4	15	3220-D	87	328-3	13	3616-D	92	440-255	1	445-0-15	11	480-TSQ-4M	49	492-A*	4	49-A-TX-30*	21
309-5	15	3222-D	87	328-4	13	3618-D	92	440-25IP	25	445-1	11	480-TSQ-5M	49	492-A-27	4	49-A-TX-40	21
309-6	15	3224-D	87	328-5	13	36MM15	116	440-26	1	445-10	11	480-TSQ-6M	49	492-A-ACR2*	5	49-B-10IP	25
309-7	15	3226-D	87	328-6	13	36MM17*	137	440-27	1	445-10-15	11	480-TSQ-8M	49	492-A-ACR2-D	5	49-B-15IP	25
309-8	15	3228-D	87	328-L	17	36MM18	144	440-27IP	25	445-1-15	11	480-TX-20	20	492-A-ACR2-R	5	49-B-20IP	25
30MM15*	116	322-L	17	328-M	17	36MM37	138	440-2-ACR2*	2	445-2	11	480-TX-25	20	492-ACR2*	5	49-B-25IP	25
30MM15-D	116	322-M	17	328-P	17	36MM38	144	440-2-ACR2-D	2	445-20	11	480-TX-27	20	492-ACR2-D	5	49-B-27IP	25
30MM17*	137	322-OL	17	328-R	17	37MM17	137	440-2-ACR2-R	2	445-20-15	11	480-TX-30*	20	492-ACR2-R	5	49-B-30IP	25
30MM18	144	322-OOL	17	328-S	17	37MM18	144	440-2-PZD*	26	445-2-15	11	480-TX-40*	20	492-AF	30	49-B-40IP	25
30MM25	117	322-OOOL	17	328-T	17	37MM38	144	440-2-SF	29	445-3	11	480-TX-40-4	20	492-A-PZD*	27	49-B-TX-05	21
30MM25-D	117	322-P	17	32MM15*	116	38MM17	137	440-3*	1	445-30	11	480-TX-40-H	20	492-A-SF	29	49-B-TX-07	21
30MM37	138	322-R	17	32MM15-D	116	38MM18	144	440-30IP	25	445-30-15	11	480-TX-45*	20	492-B*	4	49-B-TX-08*	21
30MM47	137	323-0	12	32MM17	137	38MM38	144	440-3125	1	445-3-15	11	480-TX-45-6	20	492-B-27	4	49-B-TX-09	21
30MM48	144	323-00	12	32MM18	144	3E06	92	440-32	1	445-4	11	480-TX-45-H	20	492-B-ACR2*	5	49-B-TX-10*	21
30MM55	118	323-000	12	32MM25-D	117	3E07	92	440-325	1	445-4-15	11	480-TX-50*	20	492-B-ACR2-D	5	49-B-TX-15*	21
30MM57	138	323-1	12	32MM37	138	3E08	92	440-33	1	445-5	11	480-TX-50-H	20	492-B-ACR2-R	5	49-B-TX-15-H	22
3108-D	86	323-2	13	32MM38	144	3E10	92	440-34	1	445-6	11	480-TX-55*	20	492-BF	30	49-B-TX-15-W	22
3109-D	86	323-3	13	32MM47	137	3E11	92	440-3-ACR3	2	446-1	2	480-TX-55-H	20	492-B-PZD*	27	49-B-TX-20*	21
3110-D*	86	323-4	13	32MM55	118	3E12	92	440-3-ACR3-D	2	446-12	1	485-1	12	492-B-SF	29	49-B-TX-20-H	22
3111-D	86	323-5	13	3208-D	87	3E14	92	440-3-ACR3-R*	2	446-1-PZD	26	485-2	12	492-C*	4	49-B-TX-20-W	22
3112-D	86	323-6	13	3310-D	87	3E16	92	440-3BN*	1	446-1-SF	29	485-3	12	492-C-27	4	49-B-TX-25*	21
3114-D*	86	324-0	12	3312-D*	87	3E18	92	440-3-PZD	26	446-2	2	485-4	12	492-C-ACR2-D	5	49-B-TX-27	21
3116-D	86	324-00	12	3314-D	87	3P06	92	440-3-SF	29	446-215	2	485-5	12	492-CC*	4	49-B-TX-30*	21
3117-D	86	324-000	12	3316-D	87	3P07	92	440-4*	1	446-215T	2	485-6	12	492-CF	30	49-B-TX-30-W	22
3118-D	86	324-1	13	3318-D	87	3P08	92	440-40IP	25	446-22	2	485-7*	12	492-C-SF	29	49-B-TX-40	21
3120-D	86	324-2	13	3320-D	87	3P09	92	440-4-PZD	26	446-225T	1	48MM18	144	492-F	30	49-C-TX-07	21
3121-D	86	324-20	13	3322-D	87	3P10	92	440-4-SF	29	446-22-PZD	26	48-TSQ-10M	49	492-PZD*	27	49-C-TX-08*	21

*Denotes a Rapid Select item. Refer to Page iv for description of Rapid Select.

Part No.	Page No.	Part No.	Page No.	Part No.	Page No.	Part No.	Page No.	Part No.	Page No.	Part No.	Page No.	Part No.	Page No.	Part No.	Page No.	Part No.	Page No.
49-C-TX-09	21	5132-D	105	5532-D	108	6334-D	129	6N-1416-4	63	7532-D	135	8630-D	143	A-3-11MM	159	AM-06-3	34
49-C-TX-10	21	5134-D	105	5534-D	108	6336-D	129	6N-1416-6	63	7534-D	135	8632-D	143	A-312	158	AM-06-4	34
49-C-TX-15	21	5136-D	105	55-TX-10	23	6340-D	129	6N-1418-3	63	7536-D	135	8634-D	143	A-3-12MM	159	AM-06-6	34
49-C-TX-20	21	5138-D	105	55-TX-15	23	6344-D	129	6N-1418-4	63	7624-D	136	8636-D	143	A-3-13MM	159	AM-07	34
49-C-TX-20-H	22	5140-D	105	55-TX-20	23	635-10	10	6N-1418-8	63	7626-D	136	8640-D	143	A-314	158	AM-08	34
49-C-TX-25	21	5142-D	105	55-TX-25	23	6352-D	129	6N-1420-3	63	7628-D	136	8644-D	143	A-3-14MM	159	AM-1.5MM	35
49-C-TX-27	21	5144-D	105	55-TX-30	23	635-3	14	6N-1420-6	63	7630-D	136	8646-D	143	A-3-15MM	159	AM-10	34
49-C-TX-30	21	5146-D	105	5608-D	111	635-4	14	6N-1424-3	63	7632-D	136	8648-D	143	A-316	158	AM-10MM	35
49-C-TX-40	21	5148-D	105	5609-D	111	635-5	14	6N-1424-6	63	7634-D	136	8652-D	143	A-3-16MM	159	AM-2.5MM	35
49-TSQ-10M	49	5150-D	105	5610-D	111	635-6	14	6N-2028-4	63	7636-D	136	8654-D	143	A-3-17MM	159	AM-2MM	35
49-TSQ-12M	49	5152-D	105	5612-D	111	635-7	14	6N-2036-4	63	7638-D	136	8MM03	95	A-318	158	AM-3MM	35
49-TSQ-4M	49	5154-D	105	5614-D	111	635-8	14	7120-D	133	7640-D	136	8MM11	81	A-3-18MM	159	AM-3MM-3	35
49-TSQ-5M	49	5156-D	105	5616-D	111	635-9	14	7122-D	133	7642-D	136	8MM11-D	81	A-3-19MM	159	AM-3MM-4	35
49-TSQ-6M	49	5212-D	107	5618-D	111	6414-D	128	7124-D	133	7MM03	95	8MM13	95	A-320	158	AM-4MM	35
49-TSQ-8M	49	5214-D	107	5619-D	111	6420-D	128	7126-D	133	7MM11	81	8MM13-D	95	A-322	158	AM-5MM	35
49-TX-05	21	5216-D	107	5620-D	111	6424-D	128	7128-D	133	7MM11-D	81	8MM21	81	A-324	158	AM-5MM-4	35
49-TX-06	21	5218-D	107	5622-D	111	6428-D	128	7130-D	133	7MM13	95	8MM21-D	81	A-326	158	AM-6MM	35
49-TX-07	21	5220-D	107	5624-D	111	6430-D	128	7132-D	133	7MM21	81	8MM23	96	A-328	158	AM-6MM-4	35
49-TX-08	21	5222-D	107	5626-D	111	6520-D	130	7134-D	133	7MM21-D	81	8MM23-D	96	A-5-10MM	159	AM-7MM	35
49-TX-08-W	22	5224-D	107	5628-D	111	6524-D	130	7136-D	133	7MM23	96	8MM43	96	A-5-11MM	159	AM-8MM	35
49-TX-09	21	5228-D	107	5632-D	111	6528-D	130	7138-D	133	7MM43	96	8MM43-D	96	A-512	158	AN-04	36
49-TX-09-W	22	5230-D	107	5634-D	111	6530-D	130	7140-D	133	7MM43-D	96	8MME1	83	A-5-12MM	159	AN-04-6	34
49-TX-10	21	5232-D	107	5636-D	111	6B-0808	62	7142-D	133	7MME1	83	8MME3	99	A-5-13MM	159	AN-04-A	36
49-TX-10-H	22	5234-D	107	5716-D	112	6B-0809	62	7144-D	133	7MME3	99	950-0	41	A-514	158	AN-05	36
49-TX-10-W	22	5236-D	107	5724-D	112	6B-0810	62	7148-D	133	8124-D	140	950-1	41	A-5-14MM	159	AN-05-6	36
49-TX-15	21	5238-D	107	5812-D	112	6B-0811	62	7150-D	133	8128-D	140	950-2	41	A-5-15MM	159	AN-06	36
49-TX-15-H	22	5240-D	107	5814-D	112	6B-0812	62	7152-D	133	8130-D	140	950-3	41	A-516	158	AN-06-6	36
49-TX-15-W	22	5312-D	107	5816-D	112	6B-0814	62	7154-D	133	8132-D	140	954-0	41	A-5-16MM	159	AN-07	36
49-TX-20	21	5314-D	107	5818-D	112	6B-0816	62	7156-D	133	8134-D	140	954-1	41	A-5-17MM	159	AN-07-8	36
49-TX-20-5	21	5316-D	107	5820-D	112	6B-0818	62	7158-D	133	8136-D	140	954-2	41	A-518	158	AN-08	36
49-TX-20-W	22	5318-D	107	5822-D	112	6B-0820	62	7160-D	133	8138-D	140	954-3	41	A-5-18MM	159	AN-08-8	36
49-TX-25	21	5320-D	107	5826-D	112	6MM11	81	7164-D	133	8140-D	140	954-A-0	41	A-5-19MM	159	AN-09	36
49-TX-25-W	22	5322-D	107	5828-D	112	6MM11-D	81	7166-D	133	8142-D	140	954-A-1	41	A-520	158	AN-10	36
49-TX-27	21	5324-D	107	5830-D	112	6MM13	95	7168-D	133	8144-D	140	954-A-2	41	A-5-20MM	159	AN-10-6	36
49-TX-27-W	22	5326-D	107	5832-D	112	6MM21	81	7170-D	133	8146-D	140	954-A-3	41	A-5-21MM	159	AN-10MM	36
49-TX-30	21	5328-D	107	5834-D	112	6MM23	96	7172-D	133	8148-D	140	954-B-1	41	A-522	158	AN-12	36
49-TX-30-W	22	5330-D	107	5836-D	112	6MM43	96	7176-D	133	8150-D	140	954-B-2	41	A-5-22MM	159	AN-12-6	36
49-TX-40	21	5332-D	107	5910-D	112	6MME1	83	7180-D	133	8154-D	140	954-B-3	41	A-5-23MM	159	AN-12MM	36
4MM11	81	5334-D	107	5912-D	112	6MME3	99	71-TX-06	58	8156-D	140	954-C-0	41	A-524	158	AN-14MM	36
4MME1	83	5336-D	107	5914-D	112	6N-0806-2	61	71-TX-07	58	8160-D	140	954-C-1	41	A-5-24MM	159	AN-14MM-6	36
5.5MM11	81	5338-D	107	5916-D	112	6N-0806-3	61	71-TX-08	58	8162-D	140	954-C-2	41	A-5-25MM	159	AN-16	36
5.5MM21	81	5340-D	107	5918-D	18	6N-0806-4	61	71-TX-09	58	8164-D	140	954-C-3	41	A-526	159	AN-16-6	36
5.5MME1	83	5412-D	106	591-PZD	27	6N-0806-6	61	71-TX-10	58	822-F	31	9MM03	95	A-528	159	AN-3MM	36
501-A	6	5414-D	106	5920-D	112	6N-0808-2	61	71-TX-15	58	830-1	4	9MM03-D	95	A-530	159	AN-4MM	36
502-A	6	5416-D	106	592-27	7	6N-0808-3	61	71-TX-20	58	830-2	4	9MM11	81	A-532	159	AN-5MM	36
502-ACR2	6	5418-D	106	592-PZD	27	6N-0808-4	61	71-TX-25	58	830-27	4	9MM11-D	81	A-534	159	AN-6MM	36
502-PZD	27	5420-D	106	5E08	111	6N-0808-5	61	71-TX-27	58	830-3	4	9MM13	93	A-536	159	AN-8MM	36
50MM18	144	5421-D	106	5E12	111	6N-0808-6	61	71-TX-30	58	830-4	4	9MM21	79	A-538	159	AP-08	37
50MM38	144	5422-D	106	5E14	111	6N-0810-2	61	71-TX-40	58	832-F	31	9MM21-D	79	A-540	159	AP-10	37
50-TX-08	23	5424-D	106	5E16	111	6N-0810-3	61	71-TX-45	58	833-F	31	9MM23	96	AM-02	34	AP-12	37
50-TX-10	23	5425-D	106	5E18	111	6N-0810-4	61	71-TX-50	58	834-F	31	9MM23-D	96	AM-02-3	34	AP-14MM	36
50-TX-15	23	5426-D	106	5MM11	83	6N-0810-5	61	71-TX-55	58	834-TX-25	23	9MM43	96	AM-02-A	34	AP-16	37
50-TX-20	23	5428-D	106	5MM21	81	6N-0810-6	61	7322-D	135	834-TX30-1.62	23	9MM43-D	96	AM-03	34	AP-18	37
5108-D	105	5430-D	106	5MME1	83	6N-0811-2	61	7324-D	135	834-TX40-2.95	23	9MME1	83	AM-03-3	34	AP-20	37
510-BH	55	5432-D	106	5P08	111	6N-0811-3	61	7328-D	135	834-TX-45-5	23	9MME3	99	AM-03-6	34	AP-24	37
5110-D	105	5434-D	106	5P10	111	6N-0812-2	61	7330-D	135	834-TX-50	23	A-108	158	AM-03-A	34	APH35M	40
5112-D	105	5436-D	106	5P12	111	6N-0812-3	61	7332-D	135	834-TX50-1.62	23	A-110	158	AM-04	34	APH38	39
5113-D	105	5438-D	106	5P14	111	6N-0812-4	61	7334-D	135	8430-D	141	A-1-10MM	159	AM-04-3	34	APH56	39
5114-D	105	5440-D	106	5P16	111	6N-0812-6	61	7336-D	135	8432-D	141	A-1-11MM	159	AM-04-35	34	APH56M	40
5116-D	105	5442-D	106	5P18	111	6N-0814-2	61	7338-D	135	8434-D	141	A-112	158	AM-04-4	34	APS312LM	100
5118-D	105	5512-D	108	6116-D	128	6N-0814-3	61	7424-D	134	8436-D	141	A-1-12MM	159	AM-04-5	34	APS312M	100
5119-D	105	5514-D	108	6118-D	128	6N-0814-4	61	7428-D	134	8438-D	141	A-1-13MM	159	AM-04-6	34	APS38	93
5120-D	105	5516-D	108	6120-D	128	6N-0814-6	61	7430-D	134	8440-D	141	A-114	158	AM-04-A	34	APS38L	93
5122-D	105	5518-D	108	6122-D	128	6N-0816-2	61	7432-D	134	8442-D	141	A-116	158	AM-05	34	APS38LM	100
5124-D	105	5520-D	108	6124-D	128	6N-0816-3	61	7434-D	134	8448-D	141	A-118	158	AM-05-3	34	APS38M	100
5125-D	105	5522-D	108	6130-D	128	6N-0818-2	61	7436-D	134	854-TX-50	23	A-120	158	AM-05-35	34	APS510	112
5126-D	105	5524-D	108	6322-D	130	6N-1410-3	63	7438-D	134	854-TX55-150M	23	A-1-6MM	159	AM-05-4	34	APS511M	123
5128-D	105	5526-D	108	6324-D	130	6N-1412-2	63	7440-D	134	8622-D	143	A-1-7MM	159	AM-05-5	34	APS58	112
5129-D	105	5528-D	108	6326-D	130	6N-1412-3	63	7442-D	134	8624-D	143	A-1-8MM	159	AM-05-6	34	APS58M	123
5130-D	105	552-F	31	6330-D	130	6N-1414-3	63	7448-D	134	8626-D	143	A-1-9MM	159	AM-05-8	34	APS58XL	112
5131-D	105	5530-D	108	6332-D	130	6N-1416-3	63	7530-D	135	8628-D	143	A-3-10MM	159	AM-06	34	APS58XLM	123

• Denotes a Rapid Select item. Refer to Page iv for description of Rapid Select.

Part No.	Page No.	Part No.	Page No.	Part No.	Page No.	Part No.	Page No.	Part No.	Page No.	Part No.	Page No.	Part No.	Page No.	Part No.	Page No.	Part No.	Page No.
APU37	93	EX-1003-15	145	EX-258-B-2	126	EX-377-12	127	EX-507-B-4	104	EX-752-B	132	FL-3312	91	FND-3PH	7	KA-44-4	94
APU37M	100	EX-1003-4	145	EX-260	126	EX-377-15	127	EX-507-B-6	104	EX-753	138	FL-3314	91	FND-3PZD	28	KA-44-6	94
APU56	113	EX-1003-6	145	EX-260-B	126	EX-377-2	126	EX-508-10	126	EX-753-B	138	FL-3316	91	FND-3PZD-70M	28	KA-45-3	94
AS-04	35	EX-1003-8	145	EX-262	64	EX-377-3	126	EX-508-12	126	EX-754	146	FL-3318	91	FND-TX10	24	KA-45-4	94
AS-05	35	EX-1003-B-10	145	EX-262-2	64	EX-377-4	126	EX-508-15	126	EX-754-B	146	FL-3320	91	FND-TX20	24	KA-45-6	94
AS-06	35	EX-1003-B-12	145	EX-262-3	64	EX-377-5	127	EX-508-16	126	EX-755-10	138	FL-3324	91	FND-TX25	24	KA-45-9	94
AS-07	35	EX-1003-B-15	145	EX-262-4	64	EX-377-6	127	EX-508-18	126	EX-755-12	138	FL-3326	90	FND-TX27	24	KA-6-10M-12	101
AS-08	35	EX-1003-B-4	145	EX-262-6	64	EX-377-8	127	EX-508-2	126	EX-755-15	138	FL-3410	90	FND-TX30	24	KA-6-10M-3	101
AS-10	35	EX-1003-B-6	145	EX-262-B	64	EX-377-B-10	127	EX-508-3	126	EX-755-4	138	FL-3412	90	HA-510	77	KA-6-10M-6	101
AS-12	35	EX-1003-B-8	145	EX-262-B-2	64	EX-377-B-12	127	EX-508-4	126	EX-755-6	138	FL-3414	90	HC-100-1/2	152	KA-6-10M-9	101
AW-375	59	EX-1005	148	EX-262-B-4	64	EX-377-B-4	126	EX-508-5	126	EX-755-8	138	FL-5112	109	HC-100-1/4	152	KA-7-11M-12	101
AW-95	59	EX-1005-B	148	EX-262-B-6	64	EX-377-B-3	126	EX-508-6	126	EX-755-B-10	138	FL-5114	109	HC-100-10	152	KA-7-11M-3	101
AW-95-L	59	EX-1008	146	EX-370	65	EX-377-B-4	126	EX-508-8	126	EX-755-B-12	138	FL-5116	109	HC-100-3/4	152	KA-7-11M-6	101
AW-95-LL	59	EX-1101	146	EX-370-10	65	EX-377-B-5	127	EX-508-9	126	EX-755-B-15	138	FL-5118	109	HC-100-3/8 FS	152	KA-7-12M-10	101
BNAE-3MM	31	EX-1105	148	EX-370-2	65	EX-377-B-6	127	EX-508-B-10	127	EX-755-B-4	138	FL-5120	109	HC-100-5/16	152	KA-7-12M-3	101
BNAE-4MM	31	EX-250	64	EX-370-3	65	EX-377-B-9	127	EX-508-B-12	127	EX-755-B-6	138	FL-5122	109	HC-100-5/8	152	KA-7-12M-4	101
BNAE-4MM-ACR31	31	EX-250-10	64	EX-370-4	65	EX-380	65	EX-508-B-15	127	EX-755-B-8	138	FL-5124	109	HC-100-7/16	152	KA-7-12M-6	101
BNAE-5MM	31	EX-250-12	64	EX-370-5	65	EX-380-2	65	EX-508-B-2	126	EX-756-4	146	FL-5126	109	HC-3520	86	KA-7-12M-9	101
BNAE-5MM-ACR31	31	EX-250-2	64	EX-370-6	65	EX-380-3	65	EX-508-B-3	126	EX-756-6	146	FL-5128	109	HC-3816	86	KA-7-13M-12	101
BNAE-6MM	31	EX-250-3	64	EX-370-8	65	EX-380-4	65	EX-508-B-4	126	EX-756-8	146	FL-5130	109	HC-3816-D	86	KA-7-13M-3	101
BNAE-6MM-ACR31	31	EX-250-4	64	EX-370-B	65	EX-380-6	65	EX-508-B-5	126	EX-756-B-4	146	FL-5132	109	HE-100-1/2	152	KA-7-13M-4	101
BNAE-8MM	31	EX-250-5	64	EX-370-B-10	65	EX-380-B	65	EX-508-B-6	126	EX-756-B-6	146	FL-5134	109	HE-100-1/4	152	KA-7-13M-6	101
BW-648	130	EX-250-6	64	EX-370-B-2	65	EX-380-B-2	65	EX-508-B-8	126	EX-756-B-8	146	FL-5214	110	HE-100-3/4	152	KA-7-13M-9	101
BW-748	136	EX-250-8	64	EX-370-B-3	65	EX-380-B-3	65	EX-508-B-9	126	EX-757-3	67	FL-5216	110	HE-100-3/8 FS	152	KA-7-14M-12	101
BW-7626	136	EX-250-B	64	EX-370-B-4	65	EX-500-2	66	EX-509-10	132	EX-757-B-3	67	FL-5218	110	HE-100-5/16	152	KA-7-14M-3	101
BW-848	143	EX-250-B-12	64	EX-370-B-6	65	EX-500-3	66	EX-509-12	132	EX-758-4	67	FL-5220	110	HE-100-5/8	152	KA-7-14M-4	101
BW-848-F	143	EX-250-B-2	64	EX-370-B-8	65	EX-500-4	66	EX-509-3	132	EX-758-6	67	FL-5222	110	HE-100-7/16	152	KA-7-14M-6	101
BW-8626	143	EX-250-B-3	64	EX-371	65	EX-500-6	66	EX-509-4	132	EX-758-9	67	FL-5224	110	HE-1028	106	KA-7-14M-9	101
CMS-1407	83	EX-250-B-4	64	EX-371-10	65	EX-500-B-2	66	EX-509-5	132	EX-758-B-4	67	FL-5226	110	HE-1028-D	106	KA-8-15M-12	101
CMS-1408	83	EX-250-B-5	64	EX-371-12	65	EX-500-B-3	66	EX-509-6	132	EX-758-B-6	67	FL-5228	110	HE-2422	106	KA-8-15M-4	101
CMS-1409	83	EX-250-B-6	64	EX-371-15	65	EX-500-B-4	66	EX-510-3	139	EX-759-4	67	FL-5316	110	HE-2422-D	106	KA-8-15M-6	101
CMS-1410	83	EX-250-B-8	64	EX-371-2	65	EX-500-B-6	66	EX-510-4	139	EXL-1000	155	FL-5318	110	HE-530	106	KA-8-15M-9	101
CMS-1412	83	EX-251	64	EX-371-2 3/4	65	EX-501-10	66	EX-510-6	139	EXL-1003-15	155	FL-5320	110	HE-530-D	106	KAM-25-3	104
CMS-1414	83	EX-251-10	64	EX-371-3	65	EX-501-12	66	EX-510-8	139	EXL-1003-8	155	FL-5322	110	HE-9518	107	KAM-37-3	104
CMS-1507	83	EX-251-2	64	EX-371-4	65	EX-501-15	66	EX-510-B-3	139	EXL-1100	155	FL-5324	110	HE-9518-D	107	KAM-37-B-3	104
CMS-1508	83	EX-251-3	64	EX-371-5	65	EX-501-2	66	EX-510-B-4	139	EXL-15	155	FL-5326	110	HT-848	156	KAM-38-3	104
CMS-1509	83	EX-251-4	64	EX-371-6	65	EX-501-3	66	EX-510-B-6	139	EXL-750	155	FL-5414	109	HT-848-6 1/2	156	KAM-38-6	104
CMS-1510	83	EX-251-6	64	EX-371-8	65	EX-501-4	66	EX-510-B-8	139	EXL-8	155	FL-5416	109	HTN-B-1	48	KB-10-19M-3	72
CMS-3412	112	EX-251-8	64	EX-371-B	65	EX-501-5	66	EX-512-2	66	FL-1108	79	FL-5418	109	HTN-B-2	48	KB-10-19M-6	72
CMS-3414	112	EX-251-B	64	EX-371-B-2	65	EX-501-6	66	EX-512-3	66	FL-1109	79	FL-6120	129	HTN-B-3	48	KB-10-19M-9	72
CMS-3416	112	EX-251-B-2	64	EX-371-B-3	65	EX-501-8	66	EX-512-B-2	66	FL-1110	79	FL-6124	129	HTN-B-4	48	KB-104-6	70
CMS-3418	112	EX-251-B-3	64	EX-371-B-4	65	EX-501-B-10	66	EX-512-B-4	66	FL-1111	79	FL-6128	129	HTS-0	48	KB-104-9	70
CMS-3420	112	EX-251-B-4	64	EX-371-B-6	65	EX-501-B-12	66	EX-512-1	67	FL-1112	79	FL-6132	129	HTS-1	48	KB-105-12	70
CMS-3512	112	EX-252	85	EX-372	85	EX-501-B-2	66	EX-620-6	67	FL-1114	79	FL-6320	130	HTS-10	48	KB-105-3	70
CMS-3514	112	EX-252-B	85	EX-372-B	85	EX-501-B-3	66	EX-621-3	67	FL-1116	79	FL-6324	130	HTS-12	48	KB-105-4	70
CMS-3518	112	EX-254	104	EX-374	103	EX-501-B-4	66	EX-621-4	67	FL-1118	79	FL-6326	130	HTS-2	48	KB-105-6	70
CMS-3520	112	EX-254-B	104	EX-374-B	103	EX-501-B-5	66	EX-621-6	67	FL-1212	79	FL-6328	130	HTS-3	48	KB-105-9	70
CMS-5416	125	EX-255-10	85	EX-375	126	EX-501-B-6	66	EX-621-8	67	FL-1214	79	FL-6330	130	HTS-3A	48	KB-202-12	70
CMS-5420	125	EX-255-12	85	EX-375-B	126	EX-501-B-8	66	EX-621-B-3	67	FL-1216	79	FL-HE-9518	130	HTS-4	48	KB-202-4	70
CMS-5422	125	EX-255-14	85	EX-376-10	103	EX-502	66	EX-622	104	FL-3012	90	FL-SH-335	109	HTS-4A	48	KB-202-6	70
CMS-5424	125	EX-255-2	85	EX-376-12	103	EX-502-3	66	EX-623	127	FL-3014	90	FL-SH-336	109	HTS-5	48	KB-203-12	70
CMS-5426	125	EX-255-3	85	EX-376-15	103	EX-502-4	66	EX-623-B	127	FL-3016	90	FL-SH-338	109	HTS-6	48	KB-203-3	70
CMS-5428	125	EX-255-4	85	EX-376-18	103	EX-502-5	66	EX-624	131	FL-3020	90	FL-SW-282	109	HTS-7	48	KB-203-6	70
CMS-5430	125	EX-255-6	85	EX-376-2	103	EX-502-6	66	EX-624-B	131	FL-3022	90	FL-SW-493	110	HTS-8	48	KB-203-9	70
CMS-5526	125	EX-255-8	85	EX-376-3	103	EX-502-8	66	EX-625	139	FL-3024	90	FND-185-3MM	37	HTS-9	48	KB-205-12	71
CMS-5530	125	EX-255-B-2	85	EX-376-4	103	EX-502-B	66	EX-625-B	139	FL-3108	90	FND-185-4MM	37	KA-103-3	94	KB-205-3	71
CMS-7426	138	EX-255-B-4	85	EX-376-5	103	EX-502-B-3	66	EX-626-3	127	FL-3110	90	FND-185-5MM	37	KA-103-4	94	KB-205-4	71
CMS-7428	138	EX-255-B-6	85	EX-376-6	103	EX-502-B-4	66	EX-626-4	127	FL-3112	90	FND-185-8MM	37	KA-103-6	94	KB-205-6	71
CMS-7430	138	EX-257-2	104	EX-376-8	103	EX-503	104	EX-626-6	127	FL-3114	90	FND-1PH	7	KA-104-12	94	KB-205-9	71
CMS-7432	138	EX-257-3	104	EX-376-9	103	EX-503-B	104	EX-627-10	131	FL-3116	90	FND-1PZD	28	KA-104-3	94	KB-317-3	70
CMS-8432	145	EX-257-4	104	EX-376-B-10	103	EX-504	126	EX-627-12	131	FL-3118	90	FND-2PH	7	KA-104-4	94	KB-317-6	70
CMS-8434	145	EX-257-5	104	EX-376-B-12	103	EX-504-B	126	EX-627-15	131	FL-3119	90	FND-2PH-70M	7	KA-104-6	94	KB-318-12	70
DB-08	60	EX-257-6	104	EX-376-B-15	103	EX-505	132	EX-627-4	131	FL-3120	90	FND-2PZD	28	KA-104-9	94	KB-318-3	70
DB-10	60	EX-257-B-2	104	EX-376-B-2	103	EX-505-B	132	EX-627-6	131	FL-3122	90	FND-2PZD-70M	28	KA-105-12	94	KB-318-6	71
DB-12	60	EX-257-B-3	104	EX-376-B-3	103	EX-506	139	EX-627-8	131	FL-3124	90	FND-320-A	18	KA-105-3	94	KB-318-9	71
EX-1000	139	EX-257-B-4	104	EX-376-B-4	103	EX-506-B	139	EX-628-3	139	FL-3210	91	FND-320-B	18	KA-105-4	94	KB-320-12	71
EX-1000-B	145	EX-257-B-5	104	EX-376-B-5	103	EX-507-2	104	EX-750	104	FL-3212	91	FND-320-C	18	KA-105-6	94	KB-320-3	71
EX-1001	145	EX-257-B-6	104	EX-376-B-6	103	EX-507-3	104	EX-750-B	104	FL-3214							

Part No.	Page No.	Part No.	Page No.	Part No.	Page No.	Part No.	Page No.	Part No.	Page No.	Part No.	Page No.	Part No.	Page No.	Part No.	Page No.	Part No.	Page No.
KB-321-3	71	KC-104-3	68	KD-44-6	94	KH-409-9	115	KN-45-9	114	KT-202-9	70	M-1107	78	M-16MM45	118	M3E10	92
KB-321-6	71	KC-104-6	68	KD-44-9	94	KH-43-3	114	KN-7-12M-6	123	KT-203-12	70	M-1108	78	M-17MM13	97	M3E11	92
KB-321-9	71	KC-104-9	68	KD-45-6	94	KH-43-6	114	KN-7-12M-9	123	KT-203-6	70	M-1110	77	M-17MM15	118	M3E12	92
KB-322-12	71	KC-105-12	69	KD-6-10M-12	111	KH-43-9	114	KN-7-13M-6	123	KT-203-9	70	M-1112	78	M-18MM03	97	M3E14	92
KB-322-3	71	KC-105-3	69	KD-6-10M-6	111	KH-44-3	114	KN-7-13M-9	124	KT-205-12	71	M-1114	78	M-18MM13	97	M3E16	92
KB-322-4	71	KC-105-4	69	KD-6-10M-9	111	KH-44-4	114	KN-7-14M-6	124	KT-205-6	71	M-1116	78	M-18MM15	118	M3E18	92
KB-322-6	71	KC-105-6	69	KD-7-11M-12	111	KH-44-6	114	KN-7-14M-9	124	KT-205-9	71	M-1118	78	M-18MM25	119	M3P08	92
KB-322-9	71	KC-105-9	69	KD-7-12M-12	111	KH-44-9	114	KN-8-15M-12	124	KT-317-6	70	M-1120	78	M-19MM15	118	M3P09	92
KB-40-3	70	KC-25-12	68	KD-7-12M-6	111	KH-45-3	114	KN-8-15M-6	124	KT-318-12	71	M-11MM03	97	M1E06	79	M3P10	92
KB-40-4	70	KC-25-3	68	KD-7-12M-9	111	KH-45-4	114	KN-8-15M-9	124	KT-318-3	70	M-11MM11	83	M1E07	79	M3P11	92
KB-40-6	70	KC-25-4	68	KD-7-13M-12	111	KH-45-6	114	KN-8-16M-12	124	KT-318-6	71	M-11MM13	97	M1E08	79	M3P12	92
KB-40-9	70	KC-25-6	68	KD-7-13M-6	111	KH-7-12M-12	123	KN-8-16M-6	124	KT-318-9	71	M-11MM15	118	M1E09	79	M3P14	92
KB-43-3	70	KC-25-9	68	KD-7-13M-9	111	KH-7-12M-3	123	KN-8-16M-9	124	KT-320-12	71	M-11MM21	83	M1E10	79	M3P16	92
KB-43-4	70	KC-26-12	68	KD-7-14M-6	111	KH-7-12M-4	123	KN-8-17M-6	124	KT-320-6	71	M-11MM43	97	M1E11	79	M3P18	92
KB-43-6	70	KC-26-3	68	KD-7-14M-9	111	KH-7-12M-6	123	KN-8-17M-9	124	KT-320-9	71	M-11MM45	118	M1E12	79	M-4.5MME1	83
KB-44-12	70	KC-26-4	68	KD-8-15M-12	111	KH-7-12M-9	123	KN-8-18M-12	124	KT-321-12	71	M-11MME1	83	M1E14	79	M-400	54
KB-44-3	70	KC-26-6	68	KD-8-15M-6	111	KH-7-13M-12	124	KN-8-18M-6	124	KT-321-6	71	M-11MME3	99	M1E16	79	M-44-90	52
KB-44-4	70	KC-26-9	68	KD-8-15M-9	111	KH-7-13M-3	123	KN-8-18M-9	124	KT-321-9	71	M-1208	78	M1P06	80	M-450	54
KB-44-6	70	KC-27-12	68	KDM-25-3	104	KH-7-13M-4	123	KNM-50-3	127	KT-322-12	71	M-1209	78	M1P07	80	M-460	54
KB-44-9	70	KC-27-3	68	KDM-37-3	104	KH-7-13M-6	123	KNM-50-B-6	127	KT-322-6	71	M-1210	78	M1P08	80	M-470	54
KB-45-12	70	KC-27-6	68	KDM-37-B-3	104	KH-7-13M-9	124	KS-100-6	68	KT-322-9	71	M-1211	79	M1P10	80	M-480	54
KB-45-3	70	KC-28-12	68	KDM-37-6	104	KH-7-14M-12	124	KS-100-9	68	KT-40-6	70	M-1212	79	M1P11	80	M-480-6	54
KB-45-4	70	KC-28-3	68	KDM-38-3	104	KH-7-14M-4	124	KS-101-6	68	KT-40-9	70	M-1214	79	M1P12	80	M-488	54
KB-45-6	70	KC-28-4	68	KEM-37-B-6	160	KH-7-14M-6	124	KS-102-6	68	KT-43-6	70	M-1216	79	M1P14	80	M-490	52
KB-45-9	70	KC-28-6	68	KH-10-19M-6	123	KH-8-15M-12	124	KS-102-9	68	KT-43-9	70	M-12MM03	97	M1P16	80	M-490-10	52
KB-6-10M-3	71	KC-28-9	68	KH-104-12	114	KH-8-15M-3	124	KS-103-6	68	KT-44-12	70	M-12MM11	90	M-21MM15	118	M-490-12	52
KB-6-10M-6	71	KC-29-12	68	KH-104-3	114	KH-8-15M-4	124	KS-103-9	68	KT-44-6	70	M-12MM13	97	M-3.5MME1	83	M-490-2	52
KB-6-10M-9	71	KC-29-3	68	KH-104-4	114	KH-8-15M-6	124	KS-104-6	68	KT-44-9	70	M-12MM15	118	M-3012	88	M-490-2-OR	52
KB-7-11M-12	71	KC-29-6	68	KH-104-6	114	KH-8-15M-9	124	KS-104-9	68	KT-45-12	70	M-12MM21	83	M-3014	88	M-490-4	52
KB-7-11M-3	71	KC-30-3	68	KH-104-9	114	KH-8-16M-12	124	KS-105-6	69	KT-45-6	70	M-12MM35	119	M-3016	88	M-490-6	52
KB-7-11M-4	71	KC-30-4	68	KH-105-3	114	KH-8-16M-6	124	KS-105-9	69	KT-45-9	70	M-12MM43	97	M-3018	88	M-490-8	52
KB-7-11M-6	71	KC-30-6	68	KH-105-4	114	KH-8-16M-9	124	KS-25-12	68	KT-6-10M-12	71	M-12MM45	118	M-3108	88	M-490-OR	52
KB-7-12M-3	72	KC-30-9	68	KH-105-6	114	KH-8-17M-4	124	KS-25-6	68	KT-6-10M-6	71	M-12MME1	83	M-3109	88	M-495	52
KB-7-12M-6	72	KC-5-7M-3	69	KH-202-12	114	KH-8-17M-6	124	KS-25-9	68	KT-6-10M-9	71	M-12MME3	99	M-3110	88	M-495-5	52
KB-7-12M-9	72	KC-5-7M-4	69	KH-202-3	114	KH-8-17M-9	124	KS-26-12	68	KT-7-11M-6	71	M-13MM03	97	M-3111	88	M-497	52
KB-7-13M-12	72	KC-5-7M-6	69	KH-202-6	114	KH-8-18M-3	124	KS-26-6	68	KT-7-13M-12	72	M-13MM11	83	M-3112	88	M-498	53
KB-7-13M-3	72	KC-5-7M-9	69	KH-203-12	114	KH-8-18M-4	124	KS-26-9	68	KT-7-13M-6	72	M-13MM13	97	M-3114	88	M-4MME1	83
KB-7-13M-4	72	KC-6-10M-12	69	KH-203-6	114	KH-8-18M-6	124	KS-27-6	68	KT-7-13M-9	72	M-13MM15	118	M-3115	88	M-5.5MM11	83
KB-7-13M-6	72	KC-6-10M-3	69	KH-203-9	114	KHM-50-3	127	KS-28-12	68	KT-7-14M-12	72	M-13MM21	83	M-3116	88	M-5.5MME1	82
KB-7-13M-9	72	KC-6-10M-4	69	KH-205-12	114	KHM-50-B-3	127	KS-28-6	68	KT-7-14M-6	72	M-13MM25	119	M-3117	88	M-510	54
KB-7-14M-3	72	KC-6-10M-6	69	KH-205-3	114	KN-104-12	114	KS-28-9	68	KT-7-14M-9	72	M-13MM35	119	M-3118	88	M-5108	108
KB-7-14M-4	72	KC-6-10M-9	69	KH-205-4	114	KN-104-6	114	KS-29-6	68	KT-7-15M-6	72	M-13MM43	97	M-3119	88	M-5110	108
KB-7-14M-6	72	KC-6-8M-3	69	KH-205-6	114	KN-105-6	114	KS-29-9	68	KT-7-15M-8	72	M-13MM45	118	M-3120	88	M-5112	108
KB-7-14M-9	72	KC-6-8M-4	69	KH-205-9	114	KN-105-9	114	KS-30-12	68	KT-8-13M-9	72	M-13MME1	83	M-3122	88	M-5114	108
KB-8-15M-12	72	KC-6-8M-6	69	KH-318-3	114	KN-202-12	114	KS-30-6	68	KT-8-15M-12	72	M-13MME3	99	M-320*J	17	M-5116	108
KB-8-15M-6	72	KC-6-8M-9	69	KH-318-4	114	KN-202-6	114	KS-30-9	68	KT-8-15M-6	72	M-13MME5	122	M-320*R	17	M-5118	108
KB-8-15M-9	72	KC-6-9M-3	69	KH-318-6	114	KN-202-8	114	KS-5-7M-12	69	KT-8-15M-9	72	M-14MM11	82	M-320*X	17	M-5120	108
KB-8-16M-3	72	KC-6-9M-6	69	KH-318-9	114	KN-203-12	114	KS-5-7M-6	69	KT-8-16M-12	72	M-14MM13	97	M-321*X	18	M-5122	108
KB-8-16M-6	72	KC-7-11M-3	69	KH-320-12	115	KN-203-6	114	KS-5-7M-9	69	KT-8-16M-6	72	M-14MM15	118	M-3212	89	M-5124	108
KB-8-16M-9	72	KC-7-11M-6	69	KH-320-3	114	KN-203-9	114	KS-6-10M-6	69	KT-8-16M-9	72	M-14MM21	82	M-3214	89	M-5126	108
KB-8-17M-12	72	KC-7-11M-9	69	KH-320-6	115	KN-205-12	114	KS-6-10M-9	69	KT-8-17M-6	72	M-14MM43	97	M-3216	89	M-5126	109
KB-8-17M-3	72	KC-7-12M-3	69	KH-320-9	115	KN-205-6	114	KS-6-8M-6	69	KT-8-18M-12	72	M-14MM45	118	M-3218	89	M-5218	109
KB-8-17M-6	72	KC-7-12M-6	69	KH-321-12	115	KN-205-9	114	KS-6-8M-9	69	KT-8-18M-6	72	M-1500-P	57	M-322*X	17	M-5220	109
KB-8-17M-9	72	KC-7-12M-9	69	KH-321-3	115	KN-318-3	114	KS-7-11M-6	69	KT-8-18M-9	72	M-1505-P	57	M-328*X	17	M-5316	109
KB-8-18M-12	72	KC-7-13M-3	69	KH-321-4	115	KN-318-4	114	KS-7-11M-9	69	KTM-37-3	160	M-1550-P	57	M-32-TX-15	22	M-5318	109
KB-8-18M-3	72	KC-7-13M-6	69	KH-321-6	115	KN-318-6	114	KS-7-13M-12	69	L	16	M-15MM03	97	M-32-TX-20	22	M-5412	108
KB-8-18M-6	72	KC-7-13M-9	69	KH-321-9	115	KN-320-12	115	KS-7-13M-6	69	L-320	17	M-15MM11	82	M-3408	88	M-5414	108
KB-8-18M-9	72	KCM-25-3	160	KH-322-12	115	KN-320-6	115	KS-7-13M-9	69	L-322	17	M-15MM13	97	M-3409	89	M-5416	108
KBM-37-3	160	KCM-25-B-3	160	KH-322-3	115	KN-320-9	115	KSM-25-3	160	L-328	17	M-15MM15	118	M-3410	89	M-5418	108
KC-100-12	68	KCM-37-3	160	KH-322-4	115	KN-321-6	115	KSM-25-B-3	160	M	16	M-15MM25	119	M-3411	89	M-5420	108
KC-100-3	68	KCM-37-B-3	160	KH-322-6	114	KN-321-9	115	KSM-37-3	160	M-10MM03	97	M-15MM35	119	M-3412	89	M-5512	109
KC-100-6	68	KD-103-6	94	KH-322-9	115	KN-322-12	115	KSM-37-B-4	160	M-10MM11	82	M-15MM43	97	M-3414	89	M-5518	109
KC-101-3	68	KD-104-6	94	KH-404-12	115	KN-322-6	115	KT-10-19M-12	72	M-10MM13	97	M-15MM45	118	M-3416	89	M5E08	111
KC-101-6	68	KD-105-3	94	KH-404-3	115	KN-322-9	115	KT-10-19M-6	72	M-10MM15	118	M-15MME5	122	M-3418	89	M5E10	111
KC-102-3	68	KD-105-4	94	KH-404-4	115	KN-404-12	115	KT-104-6	70	M-10MM21	82	M-15PV	59	M-3420	89	M5E12	111
KC-102-6	68	KD-105-6	94	KH-404-6	115	KN-404-6	115	KT-104-9	70	M-10MM43	97	M-15PVH	59	M-3424	89	M5E14	111
KC-102-9	68	KD-205-12	94	KH-404-9	115	KN-404-9	115	KT-105-12	70	M-10MM45	118	M-15PVH-A	59	M-3426	89	M5E16	111
KC-103-3	68	KD-205-6	94	KH-409-12	115	KN-43-6	114	KT-105-6	70	M-10MME1	83	M-15-SC	58	M-3430	89	M5E18	111
KC-103-6	68	KD-43-6	94	KH-409-3	115	KN-44-12	114	KT-105-9									

Part No.	Page No.	Part No.	Page No.	Part No.	Page No.	Part No.	Page No.	Part No.	Page No.	Part No.	Page No.	Part No.	Page No.	Part No.	Page No.	Part No.	Page No.
M5P08	111	MB-10MM23*	98	MDA-14*	60	MSH-575	151	QR-714	56	SA-221-D*	113	SA-58-18M*	123	SF-12MM35	121	SF-19MM23	99
M5P10	111	MB-10MM25*	119	MDA-6MM	60	MSW-343	96	QR-720*	56	SA-25	80	SA-601	136	SF-12MM43	99	SF-19MM25	131
M5P12	111	MB-10MM33*	98	MDA-7MM*	60	MSW-350*	151	QR-820	56	SA-25-D	80	SA-603	136	SF-12MM45	120	SF-19MM35	121
M5P14	111	MB-11MM21*	82	MDA-8MM*	60	MSW-604	96	QR-824	56	SA-26	80	SA-604	136	SF-12MM55	122	SF-19MM36*	131
M5P16	111	MB-11MM23*	98	MDA-10MM*	60	MSW-90*	151	QRA-08*	56	SA-26-D	80	SA-606	136	SF-13MM03*	98	SF-19MM43	99
M5P18	111	MB-1206	78	MDA-		MSW-90-B*	151	QRA-14	56	SA-28*	80	SA-607	136	SF-13MM11	82	SF-19MM45	120
M-610	53	MB-1208*	78	10MM-80M	60	MSW-984	15	QRF-08	56	SA-28-D	80	SA-609	136	SF-13MM13*	98	SF-19MM55	122
M-630	53	MB-1209	78	MDAT-08*	60	MSW-984-B*	151	QRF-14*	56	SA-29	80	SA-610	136	SF-13MM15*	120	SF-20MM15	120
M-638	53	MB-1210*	78	MDB-08*	56	MT-503	78	QRF-20	56	SA-29-D	80	SA-65	80	SF-13MM21	82	SF-20MM45	120
M-6MM11*	82	MB-1211*	79	MDB-10*	60	MT-752	78	QR-M-490-2	53	SA-30	80	SA-712	136	SF-13MM23*	99	SF-21MM15*	120
M-6MM13	97	MB-1212*	79	MDB-12*	60	MT-753	78	QR-M-490-		SA-301	93	SA-716	136	SF-13MM13*	121	SF-21MM16*	131
M-6MM21	82	MB-1214*	79	MDB-14*	60	MT-754	78	200M	53	SA-302	93	SA-743	136	SF-13MM33*	99	SF-21MM25*	131
M-6MM43	97	MB-1216*	79	MDC-08	60	MX-1108	78	QR-M-490-A*	53	SA-304	93	SC-108*	55	SF-13MM35*	121	SF-21MM35*	131
M-6MME1*	83	MB-1218	79	MDC-10	60	MX-1108-E*	78	QR-M-490-A6	53	SA-305	93	SC-114	55	SF-13MM43*	99	SF-21MM36*	131
M-6MME3	99	MB-12MM21*	82	MDC-12	60	MX-1109	78	R*	16	SA-306	93	SC-308*	55	SF-13MM45*	120	SF-21MM45	120
M6N-08-8M-4	62	MB-12MM23*	98	MET-1301C	156	MX-1110*	78	R-320*	17	SA-306-D	93	SC-314*	55	SF-13MM55*	122	SF-21MM55	122
M6N-08-8M-6	62	MB-12MM25	119	MET-1302C	156	MX-1111	78	R-321	18	SA-30-D	80	SC-508	55	SF-14MM03	98	SF-22MM15*	120
M6N-08-10M-4	62	MB-12MM33	98	MET-1401C	156	MX-1112*	78	R-322	17	SA-316	113	SC-514*	55	SF-14MM11	82	SF-22MM16	131
M6N-08-10M-6	62	MB-1308*	78	MET-1402C	156	MZA-110*	153	R-328	17	SA-317	113	SC-520*	55	SF-14MM13	98	SF-22MM25	121
M6N-08-12M-4	62	MB-1311	79	MET-1600C	156	MZA-310*	153	R-32-TX-27	22	SA-318	113	SC-529*	115	SF-14MM15	120	SF-22MM35	121
M6N-08-12M-6	62	MB-1312*	79	MET-1800C	156	MZA-314	153	RM-490*	52	SA-318-D	113	SC-614	55	SF-14MM21	82	SF-22MM36	131
M6N-0806-2*	61	MB-1314	79	MF-25*	82	MZA-510	153	RM-490-4	52	SA-320	113	SC-620	55	SF-14MM25	121	SF-22MM45	120
M6N-0806-3*	61	MB-13MM21*	82	MF-25-B	82	MZA-514	153	RM-490-6	52	SA-320-D	113	SC-720	55	SF-14MM35	121	SF-23MM35	121
M6N-0806-5	61	MB-13MM23*	98	MF-27	104	MZN-312	153	RP-314*	55	SA-321	113	SC-724	55	SF-14MM45	120	SF-24MM15	119
M6N-0806-6	61	MB-13MM25*	119	MF-27-B	104	MZN-314	153	RP-514*	55	SA-321-D	113	SC-728	55	SF-14MM55	122	SF-24MM16	131
M6N-0808-2*	61	MB-13MM33*	98	MF-37*	104	MZN-514	153	RP-520	55	SA-322*	113	SC-820	55	SF-15MM03	98	SF-24MM25	121
M6N-0808-3*	61	MB-14MM21	82	MF-37-B*	104	NOL	16	RP-614	55	SA-322-D	113	SC-828	55	SF-15MM11	82	SF-24MM35	121
M6N-0808-4*	61	MB-14MM23*	98	MF-38*	104	NOL-320	17	RP-620	55	SA-36-10M*	100	SD-1055-A	2	SF-15MM13	98	SF-24MM36	131
M6N-0808-5	61	MB-14MM25	119	MF-38-B	104	NOL-320	17	RP-720	55	SA-37-11M	100	SD-1342-2*	6	SF-15MM15*	120	SF-24MM55	122
M6N-0808-6*	61	MB-15MM21	82	MF-39	127	NP-32-TX-25	22	RP-724	55	SA-37-12M*	100	SD-1342-2-PZD	29	SF-15MM16*	131	SF-3010	90
M6N-0810-2*	61	MB-15MM23*	98	MF-39-B	127	OL-322	17	RP-728	55	SA-37-13M*	100	SD-2052-10	4	SF-15MM23*	99	SF-3012	90
M6N-0810-3*	61	MB-15MM25*	119	MF-50*	127	OOL-322	17	RP-820	55	SA-37-14M	100	SD-2052-8*	4	SF-15MM25*	121	SF-3014	90
M6N-0810-4*	61	MB-15MM33	98	MF-50-B*	127	OOL-322	17	RP-820-L	56	SA-38-15M*	100	SD-3749	26	SF-15MM33	99	SF-3016	90
M6N-0810-5	61	MB-15MM35	119	MF-51	132	OS-8MM13	95	RP-828	55	SA-38-17M	100	SD-4048	25	SF-15MM35*	121	SF-3018	90
M6N-0810-6*	61	MB-16MM21	82	MF-51-B	132	OS-10MM	81	S*	16	SA-38-18M	100	SD-4064-G	26	SF-15MM36*	131	SF-3028	90
M6N-0811-2	61	MB-16MM23	98	MF-55*	127	OS-10MM03	95	S-320	17	SA-402	113	SD-4693	21	SF-15MM43	99	SF-3108	90
M6N-0811-3	61	MB-16MM25	119	MF-55-B	127	OS-10MM23	96	S-321	18	SA-402-D	113	SD-556	5	SF-15MM45*	120	SF-3110	90
M6N-0812-2*	61	MB-17MM23	98	MF-62	132	OS-10MM23-D	96	S-321	18	SA-404*	113	SD-556-A	5	SF-15MM55	122	SF-3112	90
M6N-0812-3*	61	MB-18MM23*	98	MF-62-B	132	OS-3310-D	87	S-328	17	SA-404-D	113	SF-10MM03*	98	SF-16MM13	98	SF-3114	90
M6N-0812-4	61	MB-18MM25*	119	MF-70	127	OS-3410*	87	S-32-TX-30	22	SA-406	113	SF-10MM11	82	SF-16MM15	120	SF-3116	90
M6N-0812-6*	61	MB-18MM35*	119	MF-70-B	127	OS-5424	106	SA-120	93	SA-407	113	SF-10MM13*	98	SF-16MM16	131	SF-3118	90
M6N-0814-2*	61	MB-3210*	89	MF-75	139	OS-5516	108	SA-120-D	93	SA-409*	113	SF-10MM15*	120	SF-16MM25*	121	SF-3120	90
M6N-0814-3	61	MB-3212*	89	MF-75-B	139	OS-5518	108	SA-122*	93	SF-10MM21	82	SF-10MM21	82	SF-16MM35	121	SF-3122	90
M6N-0814-4	61	MB-3214*	89	MF-76	139	OSM-3410	89	SA-122-D*	93	SA-410	113	SF-10MM23*	99	SF-16MM43	99	SF-3124	90
M6N-0814-6	61	MB-3216*	89	MF-76-B	139	OSM-3414	89	SA-123*	93	SA-411	113	SF-10MM25*	121	SF-16MM45	120	SF-3212	91
M6N-0816-2*	61	MB-3218*	89	MF-77	146	OSMB-10MM21*83	99	SA-123-D	93	SA-430	130	SF-10MM33*	99	SF-16MM55	122	SF-3214	91
M6N-0816-3*	61	MB-3220	89	MF-77-B	146	OSMB-10MM23*98	98	SA-124*	93	SA-432	130	SF-10MM35	121	SF-17MM03	98	SF-3216	91
M6N-0818-2	61	MB-3314*	89	MF-79	139	OSSF-8MM23	99	SA-124-D	93	SA-434	130	SF-10MM43*	99	SF-17MM13	98	SF-3218	91
M-7MM11*	82	MB-3318	89	MF-79-B	139	OSSF-10MM23	99	SA-125*	93	SA-436	130	SF-10MM45	120	SF-17MM15*	120	SF-3220	91
M-7MM13*	97	MB-3512*	89	MF-82	146	OSSF-10MM43*	99	SA-125-D	93	SA-439	130	SF-10MM55	122	SF-17MM16	131	SF-3222	91
M-7MM21*	82	MB-3514*	89	MF-82-B	146	OSSF-3512	91	SA-15-6M	83	SA-501	113	SF-1112	79	SF-17MM23	99	SF-3224	91
M-7MME1*	83	MB-3516	89	MFL	156	OSSF-3514	91	SA-15-7M	83	SA-505	113	SF-1114	79	SF-17MM25*	121	SF-3226	91
M-7MME3*	99	MB-5.5MM21*	82	MFL-1000	156	P*	16	SA-16-10M	83	SA-508*	113	SF-1116	79	SF-17MM35	121	SF-3312	91
M-825*	55	MB-5210	109	MFL-250	156	P-1408	42	SA-16-8M	83	SA-510	113	SF-1118	79	SF-17MM43	99	SF-3314	91
M-835*	55	MB-5212	109	MFL-750	156	P-1409	42	SA-200	93	SA-510-19M	123	SF-11MM03	98	SF-17MM45*	120	SF-3316*	91
M-838*	55	MB-5214*	109	MHA-510*	78	P-1410	42	SA-201	93	SA-510-20M	123	SF-11MM11	82	SF-17MM55	122	SF-3318	91
M-855*	55	MB-5216*	109	MHC-3816	96	P-1412	42	SA-202	101	SA-510-21M	123	SF-11MM13	98	SF-18MM03	98	SF-3320	90
M-858	55	MB-5220	109	MHM-10MM	69	P-1414	42	SA-202-D	93	SA-510-22M	123	SF-11MM15*	120	SF-18MM13	98	SF-3322	91
M-8MM11*	82	MB-5MM21	82	MHM-1310	69	P-1416	42	SA-203	93	SA-510-23M	123	SF-11MM21	82	SF-18MM15*	120	SF-3324	91
M-8MM13*	97	MB-6MM21*	82	MHM-1912	69	P-320*	17	SA-203-D	93	SA-510-24M*	123	SF-11MM23	99	SF-18MM16*	131	SF-3412	90
M-8MM21*	82	MB-6MM23	98	MHM-2508	69	P-321	18	SA-205	93	SA-535	136	SF-11MM25	121	SF-18MM23	99	SF-3414	90
M-8MM43	97	MB-7MM21*	82	MHM-6MM	76	P-322	17	SA-205-D	93	SA-537	136	SF-11MM43	99	SF-18MM25*	121	SF-3416*	90
M-8MME1*	83	MB-7MM23	98	MHM-7MM	76	P-328	17	SA-216	113	SA-538	136	SF-11MM45*	120	SF-18MM35	121	SF-3418	90
M-8MME3*	99	MB-8MM21*	82	MHM-8MM	76	QR-108*	56	SA-216-D	113	SA-563	130	SF-11MM55	122	SF-18MM36*	131	SF-3420	91
M-9MM11	82	MB-8MM23*	98	MQR-15PV	68	QR-308*	56	SA-217	113	SA-565	130	SF-1212	79	SF-18MM43	99	SF-3422	90
M-9MM13	97	MB-9MM21*	82	MR-7MME1*	83	QR-314*	56	SA-217-D	113	SA-568	130	SF-12MM03	98	SF-18MM45	120	SF-3430	90
M-9MM21*	82	MB-9MM23	98	MSH-335	116	QR-508*	56	SA-218*	113	SA-57-13M*	123	SF-12MM13	98	SF-18MM55*	122	SF-3432	90
M-9MM43	97	MB-HE-9518	109	MSH-336	116	QR-514*	56	SA-218-D	113	SA-57-14M	123	SF-12MM15	120	SF-19MM03	98	SF-3512	91
M-9MME1*	83	MDA-08*	60	MSH-400	151	QR-520	56	SA-219*	113	SA-58-15M*	123	SF-12MM21	82	SF-19MM13	98	SF-3514	91
M-9MME3	99	MDA-10*	60	MSH-401	151	QR-614	56	SA-219-D	113	SA-58-16M	123	SF-12MM23	99	SF-19MM15*	120	SF-3516	91
MB-10MM21*	83	MDA-12*	60	MSH-402	151	QR-620	56	SA-221*	113	SA-58-17M*	123	SF-12MM25	121	SF-19MM16	131	SF-3518	91

Part No.	Page No.	Part No.	Page No.	Part No.	Page No.	Part No.	Page No.	Part No.	Page No.	Part No.	Page No.	Part No.	Page No.	Part No.	Page No.	Part No.	Page No.	
SF-3524	91	SF-6124	129	SH-913	151	SPL-184	155	SZ-16*	95	SZ-5-7-5MM	40	TH-377	157	TX-1412	84	WJ-284-1/4*	154	
SF-5112	109	SF-6126	129	SJ-241	160	SPL-186	155	SZ-16-A*	115	SZ-5-7-6MM	40	TH-378	157	TX-1E04	84	WJ-284-1/8	154	
SF-5114	109	SF-6128	129	SJ-349	160	SPL-188	155	SZ-16-A-3	37	SZ-5-7-8MM	124	TH-501	157	TX-1E05	84	WJ-284-13/32	154	
SF-5116	109	SF-6320	130	SJ-350	160	SW-282	105	SZ-16-A-4	37	SZ-7	38	TH-502	157	TX-1E06	84	WJ-284-3/16	154	
SF-5118	109	SF-6324	130	SJ-351	160	SW-282-D	105	SZ-17	38	SZ-7-10-10MM	40	TM-20	157	TX-1E08	84	WJ-284-3/8	154	
SF-5120	109	SF-6326	130	SJ-352	160	SW-343	86	SZ-17-A	115	SZ-7-10-12MM	40	TM-24*	157	TX-1E10	84	WJ-284-5/16	154	
SF-5122	109	SF-6328	130	SJ-360	160	SW-343-D	86	SZ-18	38	SZ-7-10-14MM	40	TN-20	157	TX-1E12	84	WJ-284-5/32	154	
SF-5124*	109	SF-6330	139	SJ-361	160	SW-350	151	SZ-18-A	115	SZ-7-10-17MM	40	TN-24	157	TX-3106	102	WJ-284-7/64	154	
SF-5126	109	SF-6418	129	SJ-362	160	SW-493	107	SZ-19	38	SZ-7-10MM	124	TW-1	46	TX-3107*	102	WJ-284-9/64	154	
SF-5128*	109	SF-6424*	129	SJ-363	160	SW-493-D	107	SZ-19-A	115	SZ-7-12MM	124	TW-10	47	TX-3108*	102	X-1108	77	
SF-5130	109	SF-6520	130	SJ-364	160	SW-604	86	SZ-20*	38	SZ-7-14MM	124	TW-11	47	TX-3110*	102	X-1110	77	
SF-5132	109	SF-6522	130	SJ-365	160	SW-604-D	85	SZ-21*	38	SZ-7-3MM	40	TW-12	47	TX-3112*	102	Y	16	
SF-5134	109	SF-6524*	130	SJ-375	160	SW-605	86	SZ-22*	115	SZ-7-4MM	101	TW-13	47	TX-3114	102	Y-321	18	
SF-5212	110	SF-6526	130	SJ-379	160	SW-605-D	86	SZ-23*	115	SZ-7-5MM	101	TW-14	47	TX-3116	102	YK-250	157	
SF-5214	110	SF-8MM11*	82	SJ-380	160	SW-90	151	SZ-24*	115	SZ-7-6MM*	101	TW-15	47	TX-3406	102	YK-251	157	
SF-5216	110	SF-8MM13*	98	SJ-55	160	SW-90-B	151	SZ-25	115	SZ-7-8MM	124	TW-2	46	TX-3407*	102	YK-252	157	
SF-5218	110	SF-8MM23*	99	SJ-66	160	SW-911-BP	57	SZ-26	115	SZ-7-A	37	TW-3*	46	TX-3408*	102	YK-370	157	
SF-5220	110	SF-9MM13	98	SJ-67	160	SW-911-P	57	SZ-27	38	SZ-80	39	TW-4*	46	TX-3410*	102	YK-371	157	
SF-5222	110	SF-HC-3816	90	SJ-68	160	SW-984	151	SZ-30	39	SZ-8-14-17MM	40	TW-5*	46	TX-3412*	102	YK-372	157	
SF-5224	110	SF-HE-9518	110	SJ-935-1/2	152	SWSC-911-C	57	SZ-30-A	39	SZ-8-14-19MM	40	TW-5-ACR	47	TX-3414	102	YK-500	157	
SF-5226	110	SF-SH-335	110	SJ-935-1/4*	152	SZ-10*	95	SZ-31	39	SZ-8-14-22MM	40	TW-6	47	TX-3416	102	YK-501	157	
SF-5228	110	SF-SH-336	110	SJ-935-	10MXM6*	152	SZ-100	39	SZ-31-A*	115	SZ-8-14-24MM	40	TW-7	47	TX-3508*	102	YK-502	157
SF-5230	110	SF-SW-282	110	SJ-935-	12MXM8*	152	SZ-100-A	39	SZ-32	39	SZ-8-14-27MM	40	TW-8	47	TX-3E08	103	ZA-110	153
SF-5232	110	SH-335	105	SJ-935-	SZ-101	39	SZ-101	39	SZ-32-A	115	SZ-82	39	TW-9	47	TX-3E10	103	ZA-112	153
SF-5314	110	SH-335-D	105	12MXM6	SZ-10-14MM	124	SZ-101-A	39	SZ-33	39	SZ-83	39	TWA-4	47	TX-3E12	103	ZA-310	153
SF-5316	110	SH-336	105	SJ-935-	SZ-10-17MM	124	SZ-101-A	39	SZ-33-A	39	SZ-84	39	TWA-5	47	TX-3E14	103	ZA-312	153
SF-5318	110	SH-336-D	105	12MXM8*	SZ-101-A	39	SZ-101-A	39	SZ-34	39	SZ-85	39	TWA-6	47	TX-3E16	103	ZA-314*	153
SF-5320	110	SH-338	105	SJ-935-	SZ-102	39	SZ-102	39	SZ-34-A	39	SZ-85-A	39	TWA-7	47	TX-5110	125	ZA-510	153
SF-5322	110	SH-338-D	105	14MXM10*	SZ-102-A	39	SZ-102-A	39	SZ-35	39	SZ-86	39	TWA-8	47	TX-5112*	125	ZA-512	153
SF-5324	110	SH-339	105	SJ-935-3/8 FS	SZ-104	39	SZ-104	39	SZ-35-A	39	SZ-87	39	TWB-6	46	TX-5114*	125	ZA-514	153
SF-5326	110	SH-339-D	105	SJ-935-5/16	SZ-10-A*	95	SZ-10-A*	95	SZ-36	39	SZ-88	39	TWB-7	46	TX-5116	125	ZE-112	153
SF-5328	110	SH-400	151	SJ-935-7/16	SZ-11*	95	SZ-11*	95	SZ-36-A	39	SZ-89	39	TWB-8	46	TX-5118*	125	ZE-312	153
SF-5330	110	SH-401	151	SPL-132	SZ-11-A*	95	SZ-11-A*	95	SZ-37	39	SZ-8L-TX-70	24	TWD-1	46	TX-5120	125	ZE-314	153
SF-5332	110	SH-402	151	SPL-134	SZ-11-A-3	37	SZ-11-A-3	37	SZ-37-10MM	40	SZ-9	38	TWD-2*	46	TX-5124	125	ZE-512	153
SF-5334	110	SH-404	151	SPL-136	SZ-12*	95	SZ-12*	95	SZ-3-7-4MM	40	SZ-91	39	TWD-3*	46	TX-5408	125	ZE-514	153
SF-5412	109	SH-406	151	SPL-138	SZ-12-A*	95	SZ-12-A*	95	SZ-3-7-5MM	40	SZ-9-A	37	TWD-4*	46	TX-5410*	125	ZN-112	153
SF-5414	109	SH-412	151	SPL-140	SZ-12-A-2	37	SZ-12-A-2	37	SZ-3-7-6MM	40	SZ-TX-100	24	TWD-4-ACR	46	TX-5412*	125	ZN-114	153
SF-5416	109	SH-413	151	SPL-142	SZ-12-A-3	37	SZ-12-A-3	37	SZ-3-7-8MM	40	SZ-TX-100-A	20	TWD-5*	46	TX-5414	125	ZN-312	153
SF-5418	109	SH-414	151	SPL-144	SZ-12-A-6	37	SZ-12-A-6	37	SZ-37-A	39	SZ-TX-55-A*	20	TWD-5-ACR	46	TX-5416	125	ZN-314	153
SF-5420	109	SH-57	151	SPL-146	SZ-13*	95	SZ-13*	95	SZ-38	39	SZ-TX-60-A	20	TWD-6*	46	TX-5418	125	ZN-512	153
SF-5422	109	SH-57-3	151	SPL-148	SZ-13-A*	95	SZ-13-A*	95	SZ-38-A	39	SZ-TX-70-A	20	TWD-7	46	TX-5420	125	ZN-514	153
SF-5424	109	SH-57-4	151	SPL-150	SZ-13-A-3	37	SZ-13-A-3	37	SZ-39	39	SZ-TX-70-A-3	20	TWE-4	46	U	16		
SF-5426	109	SH-575	151	SPL-152	SZ-14*	95	SZ-14*	95	SZ-39-A	39	SZ-TX-80-A	20	TWE-5	46	U-321	18		
SF-5514*	110	SH-57-6	151	SPL-154	SZ-14-17MM	40	SZ-14-17MM	40	SZ-40*	38	SZ-TX-90-A	20	TX-1104	84	W	16		
SF-5516	110	SH-57-8	151	SPL-156	SZ-14-19MM	40	SZ-14-19MM	40	SZ-41*	38	T*	16	TX-1105	84	W-321	18		
SF-5518*	110	SH-59	151	SPL-158	SZ-14-22MM	40	SZ-14-22MM	40	SZ-42*	115	T-320*	17	TX-1106	84	WJ-265-1/2	154		
SF-5520	110	SH-59-3	151	SPL-160	SZ-14-24MM	40	SZ-14-24MM	40	SZ-43	115	T-321	18	TX-1108*	84	WJ-265-1/4	154		
SF-5522	110	SH-59-4	151	SPL-162	SZ-14-27MM	40	SZ-14-27MM	40	SZ-44	115	T-328	17	TX-1110	84	WJ-265-1/8	154		
SF-5524*	110	SH-59-6	151	SPL-166	SZ-14-A*	115	SZ-5-10-14MM	124	SZ-5-10-14MM	124	TH-250	67	TX-1112	84	WJ-265-13/64	154		
SF-5526	110	SH-629	151	SPL-168	SZ-14-A-3	37	SZ-5-10-17MM	124	SZ-5-10-17MM	124	TH-252	67	TX-1404*	84	WJ-265-17/32	154		
SF-5528	110	SH-629P	151	SPL-170	SZ-14-A-4	37	SZ-5-10-19MM	40	SZ-5-10-19MM	40	TH-254	67	TX-1405*	84	WJ-265-3/16	154		
SF-5532	110	SH-629-3	151	SPL-174	SZ-15*	95	SZ-5-7-10MM	124	SZ-5-7-10MM	124	TH-256	67	TX-1406*	84	WJ-265-3/8	154		
SF-5534	110	SH-629-4	151	SPL-176	SZ-15-A*	115	SZ-5-7-12MM	124	SZ-5-7-12MM	124	TH-257	157	TX-1407	84	WJ-265-5/16	154		
SF-6118	129	SH-629-5	151	SPL-178	SZ-15-A-2	37	SZ-5-7-14MM	124	SZ-5-7-14MM	124	TH-370	67	TX-1408*	84	WJ-265-5/32	154		
SF-6120	129	SH-629-6	151	SPL-180	SZ-15-A-3	37	SZ-5-7-3MM	40	SZ-5-7-3MM	40	TH-372	67	TX-1410	84	WJ-265-7/16	154		
SF-6122	129	SH-629-P*	151	SPL-182	SZ-15-A-4	37	SZ-5-7-4MM	40	SZ-5-7-4MM	40	TH-376	67	TX-1411	84	WJ-265-9/64	154		

*Denotes a Rapid Select item. Refer to Page iv for description of Rapid Select.

Screwdriver Bit Quotation Worksheet

For quotation only. Not an order.



Name _____ Title _____

Company _____

Address _____

Phone _____ FAX _____

Style	Point Size	Style	Point Size
<input type="checkbox"/> Phillips	_____	<input type="checkbox"/> Frearson/Reed Prince	_____
<input type="checkbox"/> Phillips ACR®	_____	<input type="checkbox"/> Socket Head	_____
<input type="checkbox"/> Slotted	_____	<input type="checkbox"/> Socket/Robertson	_____
<input type="checkbox"/> Torx®	_____	<input type="checkbox"/> Torx-Set®	_____
<input type="checkbox"/> Torx Plus®	_____	<input type="checkbox"/> Triple Square	_____
<input type="checkbox"/> Pozidriv®	_____	<input type="checkbox"/> Tri-Wing	_____
		<input type="checkbox"/> Other	_____

Drive Type	Size
<input type="checkbox"/> Hex Insert	_____
<input type="checkbox"/> Hex Power	_____
<input type="checkbox"/> Threaded	_____
<input type="checkbox"/> Female Square	_____
<input type="checkbox"/> Other	_____

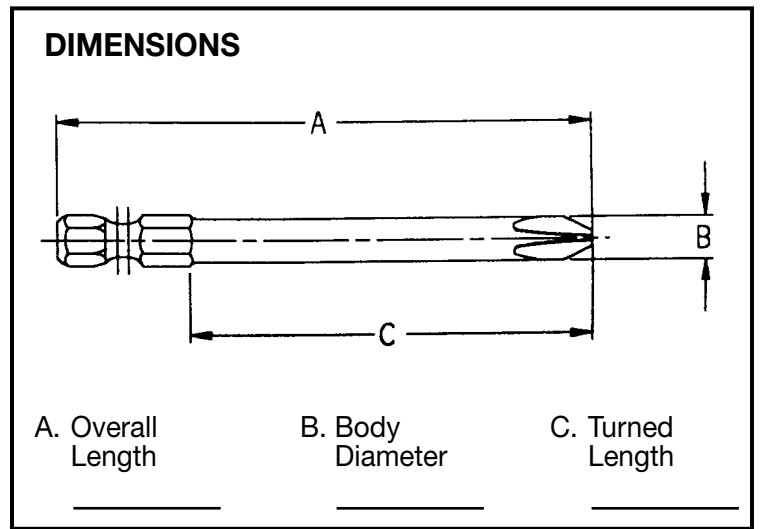

Quantity _____

APPLIED or DRIVING TORQUE _____

Additional Specifications _____

Sockets Quotation Worksheet

For quotation only. Not an order.



Name _____ Title _____

Company _____

Address _____

Phone _____ FAX _____

Socket Type

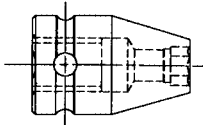

Type A (tapered)

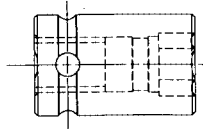

Type B (straight)

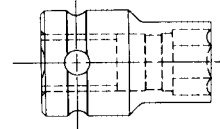

Type C (shouldered)

Broach Opening

- | | |
|--|--|
| <input type="checkbox"/> Hex | <input type="checkbox"/> Fast Lead |
| <input type="checkbox"/> Double Hex | <input type="checkbox"/> Surface Drive |
| <input type="checkbox"/> Square | <input type="checkbox"/> Torx® |
| <input type="checkbox"/> Double Square | <input type="checkbox"/> Other |

Magnetic

- Magnetic Bolt Clearance (MB)
- Magnetic Bolt Clearance, with retaining ring (RMB)
- Strip Magnet (SM)
- Fixed Magnet (M)
- Non-magnetic

Drive Configuration

- DIN Standard
- No DIN groove
- Cross Hole (one wall only)

DIMENSIONS

A. Square drive _____

B. Drive end diameter _____

C. Overall length _____

D. Taper or shoulder length _____

E. Bolt clearance depth _____

F. Broach depth _____

G. Nose end diameter _____

H. Broach opening _____

I. Torx® size _____

Quantity _____

APPLIED or DRIVING TORQUE _____

Additional Specifications _____

Universal Wrench Quotation Worksheet

For quotation only. Not an order.



Name _____ Title _____

Company _____

Address _____

Phone _____ FAX _____

DIMENSIONS

Female square drive, standard type

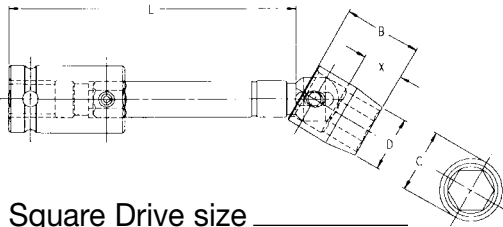

Square Drive size _____

Female square drive, tension type

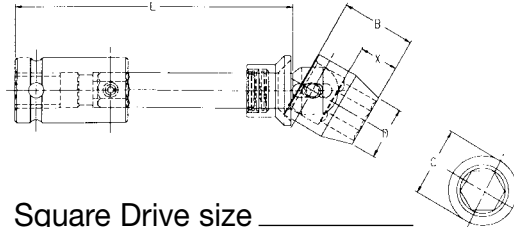

Square Drive size _____

Male hex drive, standard type

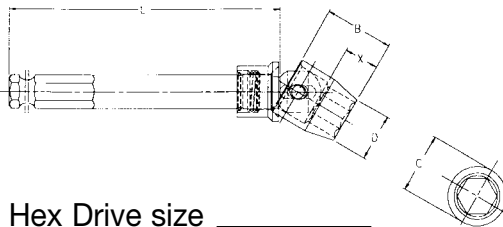

Hex Drive size _____

Male hex drive, tension type

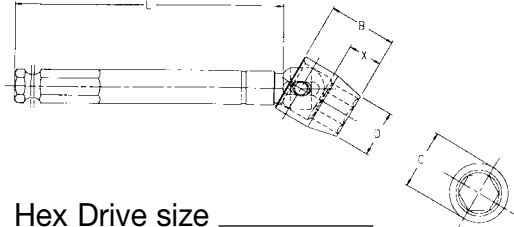

Hex Drive size _____

Female square drive, (short)

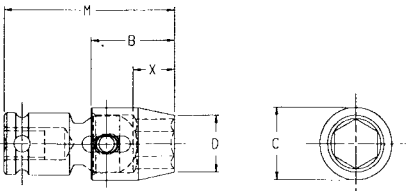

Square Drive size _____

B. Socket length _____ C. Socket diameter* _____

D. Socket nose dia. _____ G. Depth of Clearance _____

L. Shank length _____ M. Overall length _____

*Standard diameters are 5/8", 3/4", 7/8", 1", 1 1/4", 1 1/2", 1 3/4", 2"

BROACH OPENING STYLE & SIZE

Hex _____

Double Hex _____

Quantity _____

Male square

- Pin lock _____
- Ball lock _____
- Hole _____

APPLIED or DRIVING TORQUE _____

Additional Specifications _____

Conversion Chart

Inch, Fractions Inch, Decimals Millimeters

Inch, Fraction	Inch, Decimal	Millimeters	Inch, Fraction	Inch, Decimal	Millimeters	Inch, Fraction	Inch, Decimal	Millimeters	Inch, Fraction	Inch, Decimal	Millimeters
1/64	.0156	0.3969	31/64	.4844	12.3031		.9449	24.0000	1 5/8	1.6250	41.2750
1/32	.0313	0.7938	1/2	.5000	12.7000	61/64	.9531	24.2094		1.6536	42.0000
	.0394	1.000		.5118	13.0000	31/32	.9688	24.6063	1 21/32	1.6563	42.0688
3/64	.0469	1.1906	33/64	.5156	13.0969		.9843	25.0000	1 11/16	1.6875	42.8625
1/16	.0625	1.5875	17/32	.5313	13.4938	63/64	.9844	25.0031		1.6930	43.0000
5/64	.0781	1.9844	35/64	.5469	13.8906	1	1.0000	25.4000	1 23/32	1.7188	43.6563
	.0787	2.0000		.5512	14.0000		1.0237	26.0000		1.7324	44.0000
3/32	.0938	2.3813	9/16	.5625	14.2875	1 1/32	1.0313	26.1938	1 3/4	1.7500	44.4500
7/64	.1094	2.7781	37/64	.5781	14.6844	1 1/16	1.0625	26.9875		1.7717	45.0000
	.1181	3.0000		.5906	15.0000		1.0630	27.0000	1 25/32	1.7813	45.2438
1/8	.1250	3.1750	19/32	.5938	15.0813	1 3/32	1.0938	27.7813		1.8111	46.0000
9/64	.1406	3.5719	39/64	.6094	15.4781		1.1024	28.0000	1 13/16	1.8125	46.0375
5/32	.1563	3.9688	5/8	.6250	15.8750	1 1/18	1.1250	28.5750	1 27/32	1.8438	46.8313
	.1575	4.0000		.6299	16.0000		1.1418	29.0000		1.8505	47.0000
11/64	.1719	4.3656	41/64	.6406	16.2719	1 5/32	1.1563	29.3688	1 7/8	1.8750	47.6250
3/16	.1875	4.7625	21/32	.6563	16.6688		1.1812	30.0000		1.8898	48.0000
	.1969	5.0000		.6693	17.0000	1 3/16	1.1875	30.1625	1 29/32	1.9063	48.4188
13/64	.2031	5.1594	43/64	.6719	17.0656	1 7/32	1.2188	30.9563		1.9292	49.0000
7/32	.2188	5.5563	11/16	.6875	17.4625		1.2205	31.0000	1 15/16	1.9375	49.2125
15/64	.2344	5.9531	45/64	.7031	17.8594	1 1/4	1.2500	31.7500		1.9686	50.0000
	.2362	6.0000		.7087	18.0000		1.2599	32.0000	1 31/32	1.9688	50.0063
1/4	.2500	6.3500	23/32	.7188	18.2563	1 9/32	1.2813	32.5438	2	2.0000	50.8000
17/64	.2656	6.7469	47/64	.7344	18.6531		1.2993	33.0000		2.0080	51.0000
	.2756	7.0000		.7480	19.0000	1 5/16	1.3125	33.3375	2 1/32	2.0313	51.5938
9/32	.2813	7.1438	3/4	.7500	19.0500		1.3386	34.0000		2.0473	52.0000
19/64	.2969	7.5406	49/64	.7656	19.4469	1 11/32	1.3438	34.1313	2 1/16	2.0625	52.3875
5/16	.3125	7.9375	25/32	.7813	19.8438	1 3/8	1.3750	34.9250		2.0867	53.0000
	.3150	8.0000		.7874	20.0000		1.3780	35.0000	2 3/32	2.0938	53.1813
21/64	.3281	8.3344	51/64	.7969	20.2406	1 13/32	1.4063	35.7188	2 1/8	2.1250	53.9750
11/32	.3438	8.7313	13/16	.8125	20.6375		1.4174	36.0000		2.1261	54.0000
	.3543	9.0000		.8268	21.0000	1 7/16	1.4375	36.5125	2 5/32	2.1563	54.7688
23/64	.3594	9.1281	53/64	.8281	21.0344		1.4568	37.0000		2.1654	55.0000
3/8	.3750	9.5250	27/32	.8438	21.4313	1 15/32	1.4688	37.3063	2 3/16	2.1875	55.5625
25/64	.3906	9.9219	55/64	.8594	21.8281		1.4961	38.0000		2.2048	56.0000
	.3937	10.0000		.8661	22.0000	1 1/2	1.5000	38.1000	2 7/32	2.2188	56.3575
13/32	.4063	10.3188	7/8	.8750	22.2250	1 17/32	1.5313	38.8938		2.2442	57.0000
27/64	.4219	10.7156	57/64	.8906	22.6219		1.5355	39.0000	2 1/4	2.2500	57.1500
	.4331	11.0000		.9055	23.0000	1 9/16	1.5625	39.6875	2 9/32	2.2813	57.9450
7/16	.4375	11.1125	29/32	.9063	23.0188		1.5749	40.0000		2.2835	58.0000
29/64	.4531	11.5094	59/64	.9219	23.4156	1 19/32	1.5938	40.4813	2 5/16	2.3125	58.7375
15/32	.4688	11.9063	15/16	.9375	23.8125		1.6143	41.0000		2.3228	59.0000
	.4724	12.0000									



AIRETOOL®
APEX® • BUCKEYE®
CAMPBELL® • CLECO®
COOPER AUTOMATION™ • CRESCENT®
DGD® • DOLER® • DOTCO® • EREM®
GARDNER-DENVER® • GARDOTRANS™
GETA™ • KAHNETICS® • LUFKIN®
MASTER POWER® • METRONIX™
NICHOLSON® • PLUMB® • H.K. PORTER®
QUACKENBUSH™ • RECOULES™ • ROTOR™
UTICA® • WELLER® • WIRE-WRAP®
WISS® • XCELITE®

Apex Operation
P.O. Box 952
Dayton, OH 45401-0952
Phone: (937) 222-7871
Fax: (937) 228-0422
www.cooperindustries.com