

Humble Pi v1.3 Getting started guide

CISECO

Always read this guide before beginning. This kit requires basic soldering skills before use.

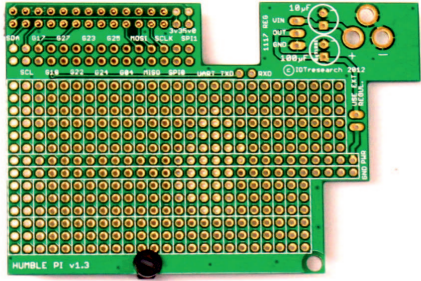

The Humble Pi is a self assembly add on for the Raspberry Pi computer. The board has a large electronic prototyping area for soldering parts to make custom circuits connected to the Pi. The solderable pads are arranged in threes around two central power connectors. This makes the Pi the easiest product of it's type to use. All the GPIO pins for the Pi are broken out into easy to solder pads. There is space to add an optional voltage regulator to power projects when the power from the Pi is insufficient.

1

You will need these tools

- 1 x Soldering iron
- 1 x Length of electronics solder wire (not plumbers solder)
- 1 x Side cutters



Optional but will make the build much easier

- 1 x Blob of Blu-tack
- 1 x Multimeter (preferably with continuity check)



Note: The Blu-tack is very good at holding parts while soldering. Checking the solder joints for good connections will in our experience save you time overall

2

First check the contents for 4 items

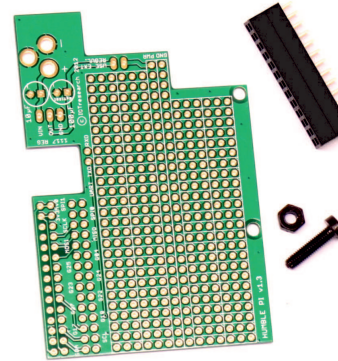

- 1 x Green printed circuit board (PCB)
- 1 x 2x13 female 2.54mm pitch connector
- 1 x M3.5 12mm nylon screw
- 1 x M3.5 nylon nut

For help please email: somethingismissing@ciseco.co.uk

3

Deciding what order to fit the parts

We suggest you normally start with the smallest height parts first, leaving the larger parts till later on, this usually leaves most room to manoeuvre the iron.

Dry fit the parts

What is a really good thing to do on boards where the parts are close to each other is to do a "dry fit" first.

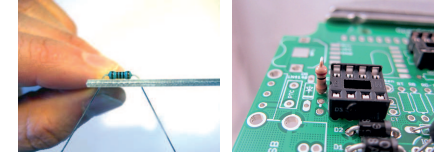

This means pushing parts into place without soldering so you can decide what order is easiest for you. Left handed people almost always decide to do things in a different order to a right handed person for example. The order is ultimately up to you so don't rush in, think about it first.

Not confident in soldering?

Google "soldering guide" or "soldering how to". There's many great articles that people have produced. There's videos on YouTube also. Soldering is simple to learn. Why not ask your local school / college for a little help or what we hope people have near them is a Hackspace or Makerspace (google it) they are brilliant places to join.

4

Solder the parts

Soldering normal electronic parts (none in this kit)

1. Carefully push the part through the board, hold in place by either Blu-tack or gently bending the part legs before turning upside down to solder. DO NOT hold with your finger, most parts easily conduct heat, don't burn yourself!

Soldering connectors (some are in this kit)

1. Using the Blu-tack or your fingers, hold the connector in place and solder just a single pin at one end.
2. Check that the connector is aligned in every direction, if not simply reheat for a second or two and gently move. Avoid excessive heat and always be patient, soldering is a skill anyone can do badly, doing it well is about practice and not rushing things.
3. When you are happy, solder the pin at the opposite end of the connector. Check visually **very carefully** again as this is the last time it will be easy to move position of the part. Complete by soldering the rest of the connector pins.

Soldering surface mount parts (none in this kit)

1. Tin (cover in a coat of solder) a single pad first, put the part on top, perfectly aligned with the other pads. Melt the tinned pad so that the first pin is soldered down. Re-melt till the part is aligned then solder the rest of the pads. Tweezers are perfect for holding parts, whilst soldering.

Handy tips for this kit (the Humble Pi)

1. Only install the connectors you actually need for your project you can always add the ones you didn't use later if needed.

5

Locations of the parts

Install the 2 row x 13 way header as shown, make sure the end 4 holes are not soldered.

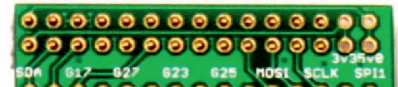

The spacer nut and bolt can be used in any hole, you should decide where this gives greatest stability.

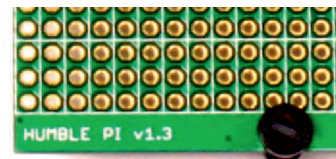

6

Check everything

Even if you are confident in soldering, please still check your work. Almost all the problems we see (where boards do not function correctly) are down to a poor/dry joint somewhere.

With a multimeter make sure you have good connections between the various pins. On the back of this page is the schematic layout so you can see what is connected where.

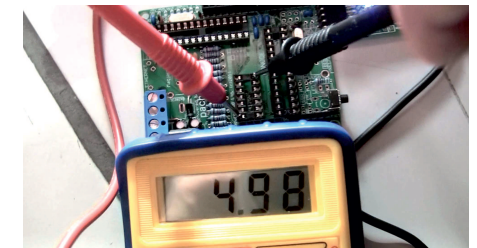

Testing & Building your projects

Build and test as you go in small stages, take your time and always check twice before soldering, this extra small amount of effort is always worthwhile. Rushing is the best recipe for getting things wrong, backwards or poorly soldered.

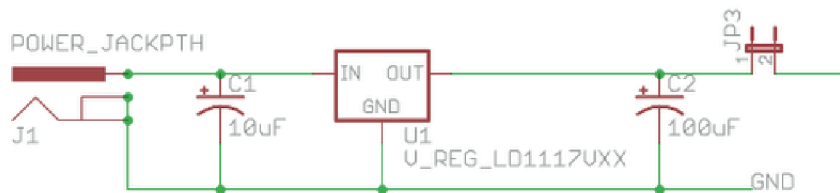
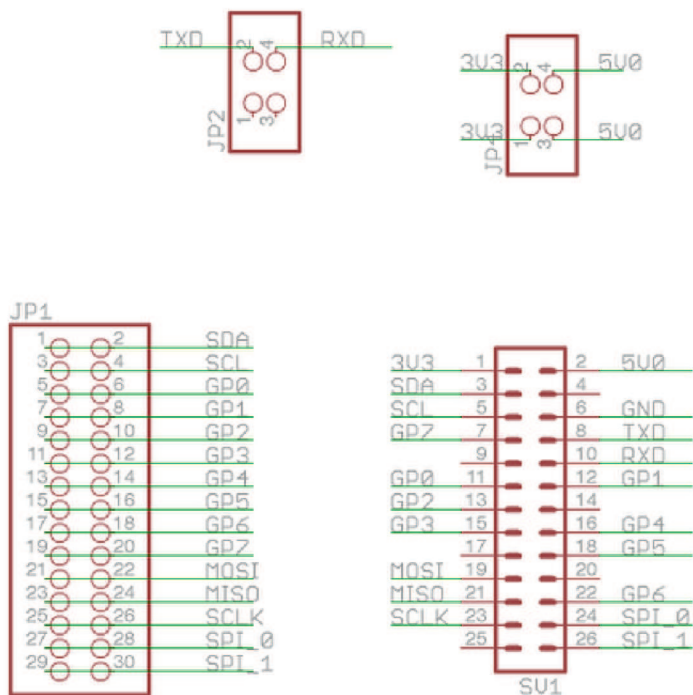

Now your kit is built here comes the interesting part. What are you going to do with it? Our forum is a great place to discuss your ideas with others. We love to hear what people are up to and have built.

Feel free to drop in and say hello. Our forum is not just about our products it's also intended for any discussion and sharing about the use of computers with microcontrollers, electronics and wireless.

www.openmicros.org

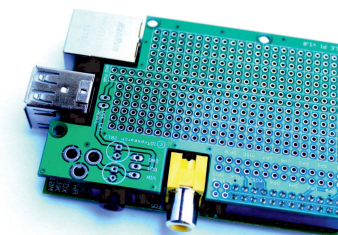

what your board might look when installed

Last point of manufacture UK

Ciseco Plc,
Cleantech Centre,
St Peters St,
Nottingham
NG7 3EN

Always recycle where possible.

Blutack is a registered name of Bostik Limited

Raspberry Pi is a registered name of the Raspberry Pi Foundation

