



## MIC864

### Dual 350kHz Rail-to-Rail Operational Amplifier

#### General Description

The MIC864 is a dual operational amplifier offering small-size, low-power consumption (33 $\mu$ A/channel typical), 'greater-than-the-rails' input capability, and output range to within 15mV of the supply rails. The MIC864 can be operated with a single supply of +2.5V to +5.5V or a dual-supply of  $\pm$ 1.25V to  $\pm$ 2.75V, and features an excellent speed/power ratio with a gain bandwidth product of 350kHz.

The MIC864 was designed with input stage transconductance normalization, making it immune to common-mode rejection ratio (CMRR) and power supply rejection ratio (PSRR) degradation across the input voltage range. This feature makes the MIC864 superior to some earlier operational amplifiers, in which a region of the input voltage range was subject to degraded performance.

The MIC864 is available with an industry standard pin configuration in an 8-pin SOIC package, and is specified to operate from  $-40^{\circ}$ C to  $+125^{\circ}$ C junction temperature.

Data sheets and support documentation can be found on Micrel's web site at: [www.micrel.com](http://www.micrel.com).

#### Features

- 2.5V to 5.5V single or  $\pm$ 1.25V to  $\pm$ 2.75V dual supply voltage
- 33 $\mu$ A per channel quiescent current
- 350kHz gain bandwidth product
- 0.2V/ $\mu$ s slew rate
- 18mA output drive capability (sink or source)
- 200mV greater-than-the-rails input capability
- Rail-to-rail output (within 15mV)
- 80dB common mode rejection ratio (CMRR)
- 80dB power supply rejection ratio (PSRR)
- 8-pin SOIC Package

#### Applications

- Battery-powered equipment
- Cellular phone PA biasing circuits
- Carbon monoxide detectors
- Smoke detectors

#### Pin Configuration

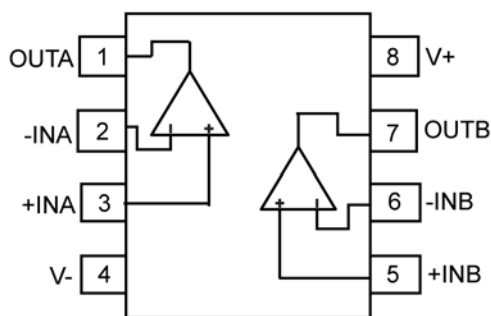

MIC864 8-Pin SOIC (M)  
(Top View)

## Ordering Information

Part Number	Junction Temperature Range	Package
MIC864YM	-40°C to +125°C	8-Pin SOIC

## Pin Configuration

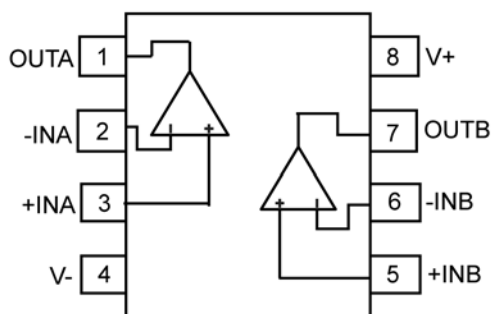

MIC864 8-Pin SOIC (M)  
(Top View)

## Pin Description

Pin Number	Pin Name	Pin Function
1	OUTA	Output of operational amplifier A.
2	-INA	Inverting input of operational amplifier A.
3	+INA	Non-inverting input of operational amplifier A.
4	V-	Negative Power Supply Connection. Connect to GND for single supply operation.
5	+INB	Non-inverting input of operational amplifier B.
6	-INB	Inverting input of operational amplifier B.
7	OUTB	Output of operational amplifier B.
8	V+	Positive Power Supply Input. Connect a 0.1 $\mu$ F ceramic bypass capacitor from V+ to V-, placed within 0.2in (5mm) of the MIC864.

**Absolute Maximum Ratings<sup>(1)</sup>**

Supply Voltage (V+ to V-)	+6.0V
Differential Input Voltage ( $ V_{+IN} - V_{-IN} $ )	+6.0V
Input Voltage ( $V_{+IN}, V_{-IN}$ )	(V+) + 0.2V, (V-) - 0.2V
Output Short-Circuit Duration	Continuous
Lead Temperature (soldering, 10s)	260°C
Storage Temperature ( $T_S$ )	-65°C to +150°C
Junction Temperature ( $T_J$ )	-40°C to +150°C
ESD Rating <sup>(3)</sup>	ESD Sensitive

**Operating Ratings<sup>(2)</sup>**

Supply Voltage (V+ to V-)	+2.5V to +5.5V
Differential Input Voltage ( $ V_{+IN} - V_{-IN} $ )	+2.5V to +5.5V
Input Voltage ( $V_{+IN}, V_{-IN}$ )	(V+) + 0.2V, (V-) - 0.2V
Ambient Temperature ( $T_A$ )	-40°C to +125°C
Package Thermal Resistance	
SOIC-8 ( $\theta_{JA}$ )	99°C/W

**Electrical Characteristics<sup>(4)</sup>**

V+ = +2.5V, V- = -2.5V,  $V_{CM} = ((V+) - (V-))/2$ ;  $R_L = 100k\Omega$  connected to  $((V+) - (V-))/2$ ;  $T_J = +25^\circ\text{C}$ , unless otherwise noted.

**Bold** values indicate  $-40^\circ\text{C} \leq T_J \leq +125^\circ\text{C}$ .

Symbol	Parameter	Condition	Min.	Typ.	Max.	Units
V <sub>OS</sub>	Input Offset Voltage			2	<b>8</b>	mV
	Input Offset Voltage Temperature Coefficient			4		$\mu\text{V}/^\circ\text{C}$
I <sub>B</sub>	Input Bias Current			$\pm 2.5$	$\pm 20$	pA
I <sub>OS</sub>	Input Offset Current			$\pm 0.5$	$\pm 15$	pA
V <sub>CM</sub>	Input Voltage Range		(V-) - 0.2		(V+) + 0.2	V
CMRR	Common-Mode Rejection Ratio	$(V-) - 0.2\text{V} < V_{CM} < (V+) + 0.2\text{V}$	54	80		dB
PSRR	Power Supply Rejection Ratio	$2.5 < V_S < 5.25\text{V}$		80		dB
A <sub>VOL</sub>	Large-Signal Voltage Gain	$C_L = 100\text{pF}, R_L = 100k\Omega$		80		dB
V <sub>OUT</sub>	Maximum Output Voltage Swing	$R_L = 100k\Omega$	<b>(V-) + 0.015</b>		<b>(V+) - 0.015</b>	V
		$R_L = 5k\Omega$	<b>(V-) + 0.125</b>		<b>(V+) - 0.125</b>	
GBW	Gain-Bandwidth Product	$C_L = 100\text{pF}, R_L = 100k\Omega$		350		kHz
SR	Slew Rate	$A_V = 1, C_L = 100\text{pF}, R_L = 100k\Omega$		0.2		V/ $\mu\text{s}$
I <sub>SC</sub>	Short-Circuit Output Current	Source, $R_L$ connected to V-		23		mA
		Sink, $R_L$ connected to V+		15		
I <sub>S</sub>	Supply Current per Amplifier	No Load		33	<b>50</b>	$\mu\text{A}$

**Notes:**

- Exceeding the absolute maximum rating may damage the device.
- The device is not guaranteed to function outside its operating rating.
- Devices are ESD Sensitive. Handling precautions recommended. Human body model, 1.5k $\Omega$  in series with 100pF.
- Specification for packaged product only.

## Typical Characteristics

$V_+ = V_S/2 = 2.5V$ ,  $V_- = -V_S/2 = -2.5V$ ,  $R_L = 100k\Omega$ ,  $R_L$  and  $C_L$  connected in parallel to GND;  $T_A = +25^\circ C$ , unless otherwise noted.

PSRR vs. Frequency

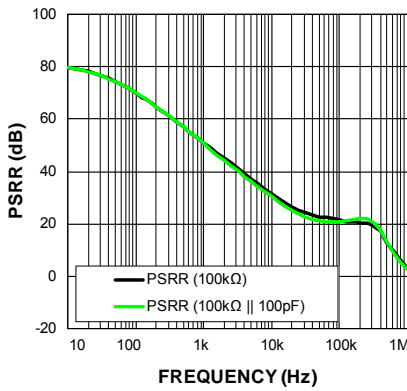

CMRR vs. Frequency

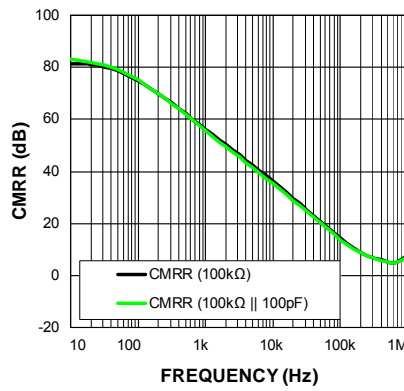

Open-Loop Gain and Phase vs. Frequency

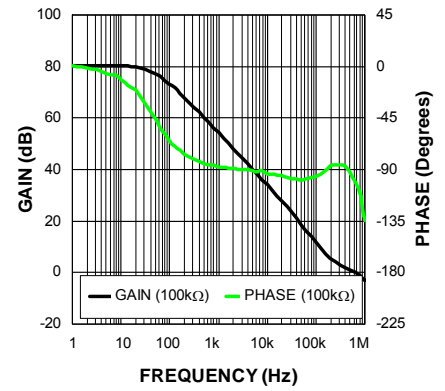

Open-Loop Gain and Phase vs. Frequency

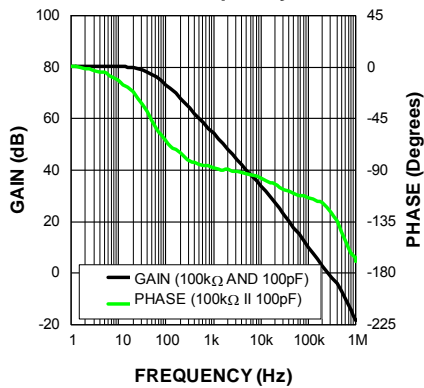

Open-Loop Gain and Phase vs. Frequency

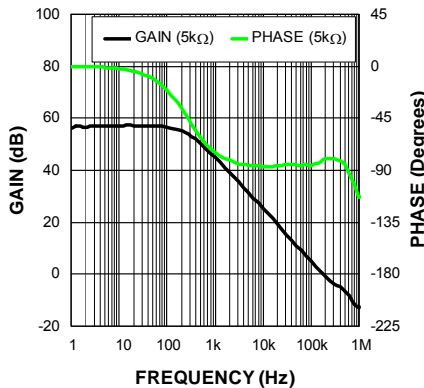

Open-Loop Gain and Phase vs. Frequency

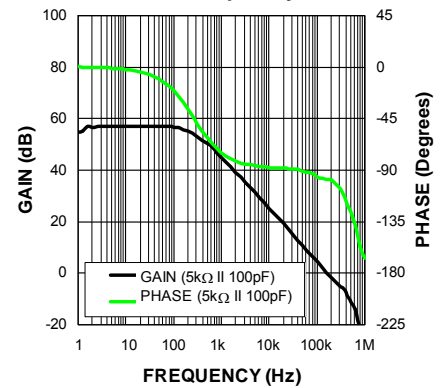

Output Voltage Swing vs. Output Current

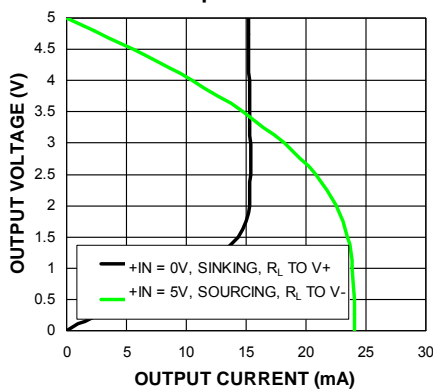

Supply Current vs. Supply Voltage

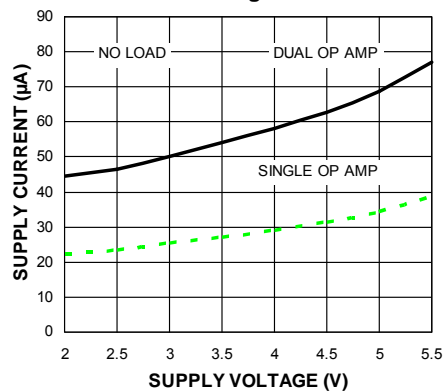

Short Circuit Current vs. Supply Voltage

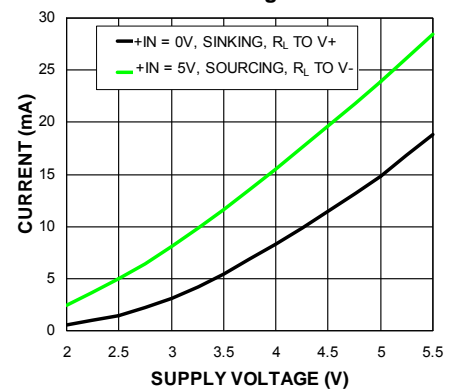

## Functional Characteristics

$V_+ = V_S/2 = 2.5V$ ,  $V_- = -V_S/2 = 2.5V$ ,  $R_L = 100k\Omega$ ,  $R_L$  and  $C_L$  connected in parallel to GND;  $T_A = +25^\circ C$ , unless otherwise noted.

**Small Signal Step Response (Inverting)**

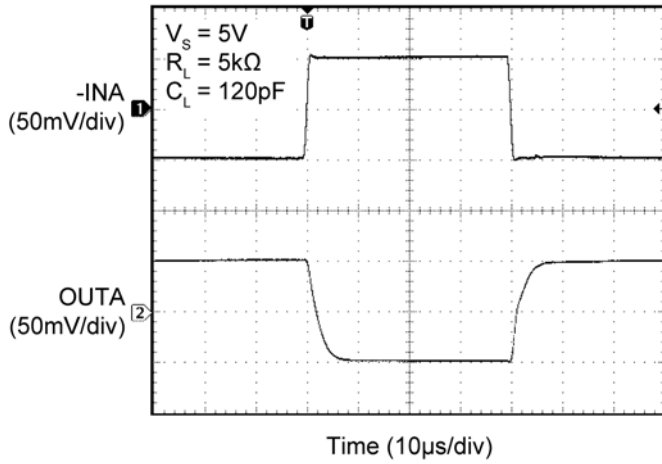

**Small Signal Step Response (Inverting)**

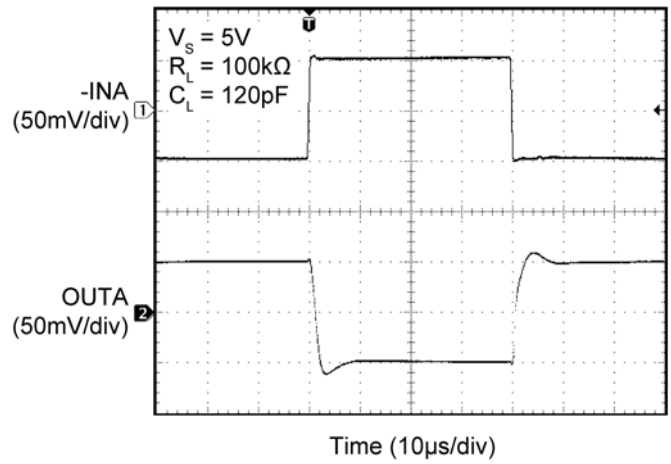

**Large Signal Step Response (Inverting)**

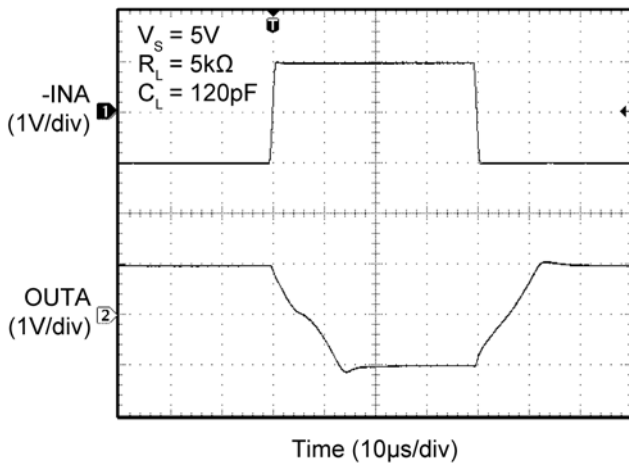

**Large Signal Step Response (Inverting)**

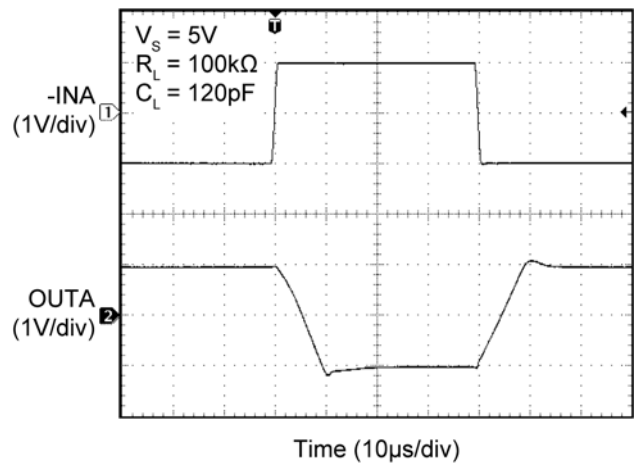

**Small Signal Step Response (Non-Inverting)**

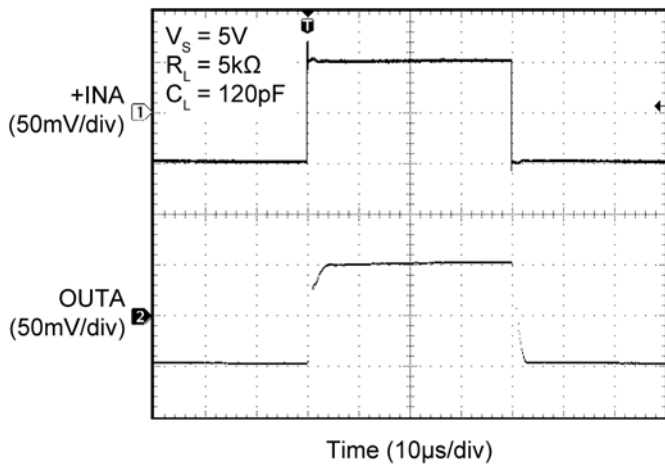

**Small Signal Step Response (Non-Inverting)**

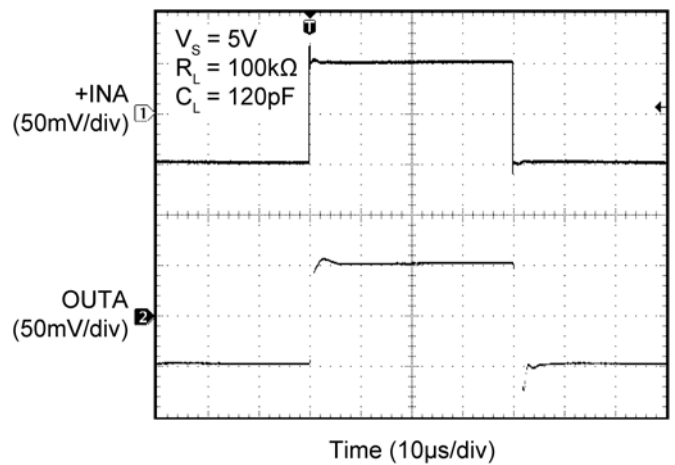

## Functional Characteristics (Continued)

$V_+ = V_S/2 = 2.5V$ ,  $V_- = -V_S/2 = 2.5V$ ,  $R_L = 100k\Omega$ ,  $R_L$  and  $C_L$  connected in parallel to GND;  $T_A = +25^\circ C$ , unless otherwise noted.

**Large Signal Step Response (Non-Inverting)**

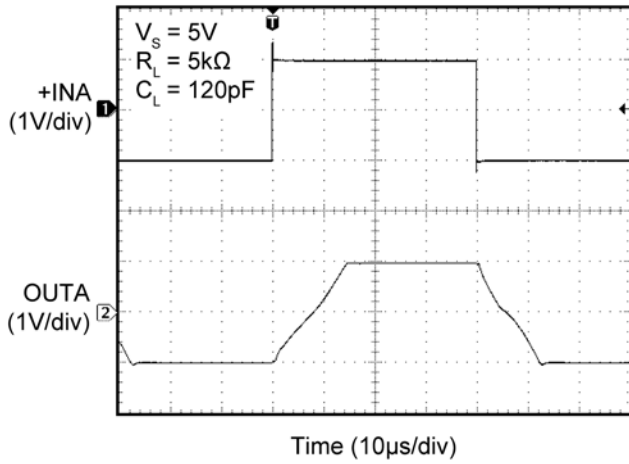

**Large Signal Step Response (Non-Inverting)**

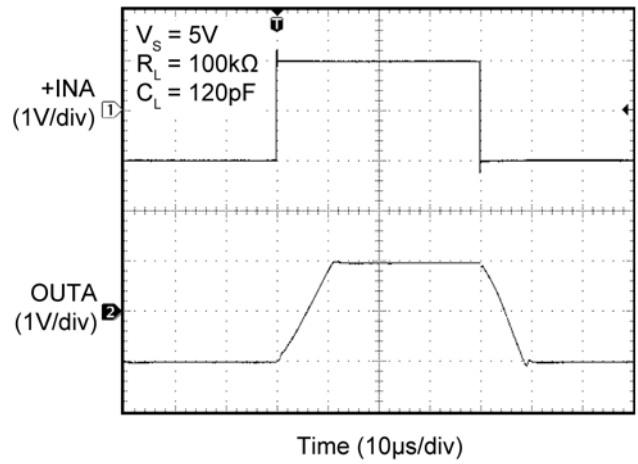

**Channel A – B Separation**

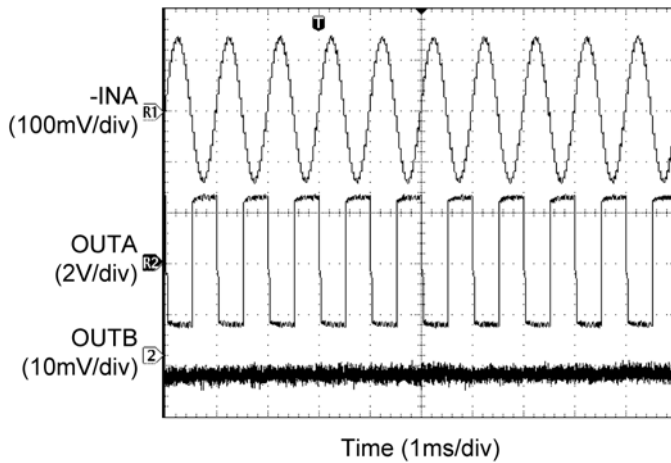

**0.1Hz to 10Hz Input Referred Voltage Noise**

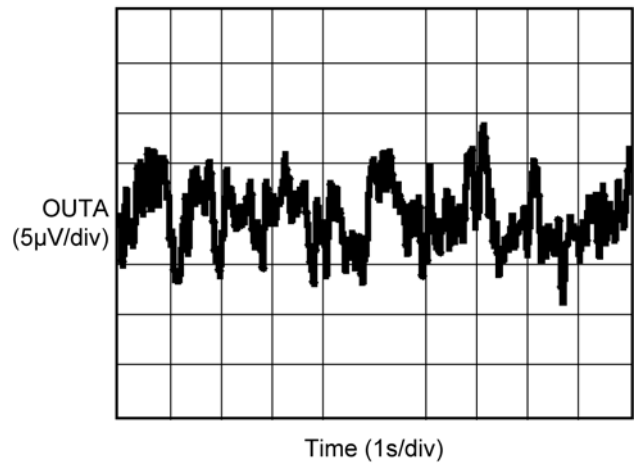

## Functional Description

The MIC864 is a dual-operational amplifier with an input range 0.2V greater than the supply rails and an output range to within 15mV of the supply rails (100k $\Omega$  load). The MIC864 can be operated from a single from 2.5V to 5.5V supply or a dual  $\pm 1.25V$  to  $\pm 2.75V$  supply. It features a low 33 $\mu A$  quiescent current per channel with a gain bandwidth product of 350kHz.

Compared with other operational amplifiers in its class, the MIC864 offers dependable CMRR and PSRR. This is achieved through transconductance normalization, which ensures consistent performance across the entire input voltage range. This feature eliminates a region of the input voltage range where some earlier operational amplifiers were subject to degraded CMRR and PSRR.

### Input Stage

The MIC864 uses parallel NFET and PFET differential input transistor pairs for a common-mode input voltage range beyond the supply rails. When input voltages are high, the NFET differential input pair operates. When input voltages are low, the PFET differential input pair operates.

## Functional Diagram

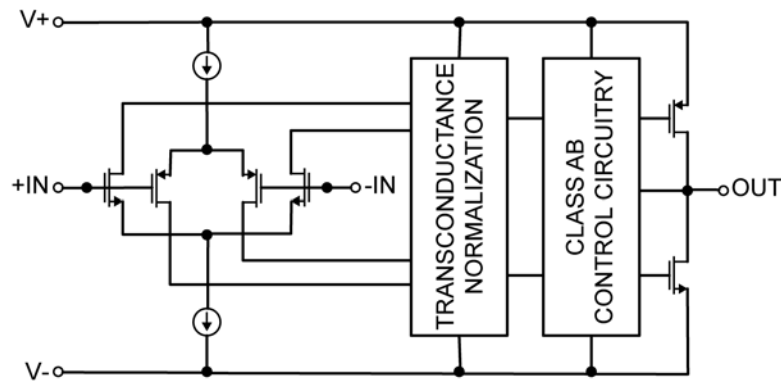

MIC864 Block Diagram

### Transconductance Normalization

Hand-off between the NFET and PFET differential pairs is managed by the transconductance normalization circuit block. As the common-mode input voltage transitions between high and low voltages, this circuit block ensures smooth, consistent, and continuous operation.

### Class AB Output Stage

Low output impedance is achieved by driving the common-emitter output stage with a class AB control circuit. In contrast with the common collector output stages of earlier operational amplifiers, this allows an output range very close to the supply rails.

## Application Information

The MIC864 operational amplifier is optimized for portable applications such as cell phones, computer pads, media players, mobile chemical sensors, carbon monoxide detectors, and smoke detectors. A 2.5V to 5.5V supply voltage range allows operation from the regulated output of a lithium-ion battery. No-load supply current is 33 $\mu$ A per channel for long battery life. An input range 0.2V beyond the supply rails and an output range to within 15mV of the supply rails (100k $\Omega$  load) maximize dynamic range for improved signal to noise ratios in the application. High, consistent CMRR and PSRR minimize power supply noise coupling from adjacent circuitry.

### Input protection

The IN- and IN+ inputs of the MIC864 are clamped to the V+ and V- pins using ESD protection diodes. Operation of IN+ or IN- beyond (V+) + 0.2V and (V-) - 0.2V is not recommended as this would turn on the ESD protection diodes and violates the Absolute Maximum Ratings.

### Feedback

Feedback resistors in the 5k $\Omega$  and 100k $\Omega$  range are recommended. Load resistance and capacitance requirements must be considered when designing the feedback network, especially in unity-gain and low-gain circuits (see "Capacitive and Resistive Loads" section for further information).

When using high-value feedback resistors, place a low-value capacitor in parallel with the resistor connected between IN- and OUT. This capacitor counteracts the effects of the parasitic capacitance at the IN- pin which forms a pole that may otherwise degrade stability. However, a 68pF minimum load capacitance must be included to ensure stability.

When AC-coupling signals to the MIC864 through a capacitor, provide a DC-bias current path using a resistor. Otherwise, there will be no source for supplying the input bias current and the circuit will stop working.

### Power Supply Bypassing

For single supply operation, connect a 0.1 $\mu$ F ceramic capacitor between the V+ and V- power supply pins. For dual supply operation, connect 0.1 $\mu$ F capacitors from V+ to GND and from GND to V-. Place these capacitors within 0.2in (5mm) of the MIC864. If no large-value capacitors are nearby then also include 10 $\mu$ F capacitors connected in similar fashion.

### Capacitive and Resistive Loads

The MIC864 is internally compensated for unity-gain stability with load resistances between 5k $\Omega$  and 100k $\Omega$ , and a 100pF load capacitance. A 68pF minimum load capacitance is required to ensure unity-gain stability across production and temperature variations. Care should be taken to observe the minimum load capacitance requirement in circuits with a gain less than 2, and in circuits with a capacitor connected between the IN- and OUT pins.

### Driving ADCs

ADCs (analog-to-digital converters) typically include either a capacitive sample-and-hold or a capacitive DAC at their inputs. During operation, they periodically connect those capacitors to their inputs while sampling the input signal. General practice is to place a RC low-pass filter between the operational amplifier supplying the input signal and the ADC. The series resistor between the operational amplifier output and ADC input limits capacitive loading on the operational amplifier to prevent instability. The capacitor between the ADC input and GND minimizes glitches by supplying charge to the internal ADC capacitors.



# Package Information

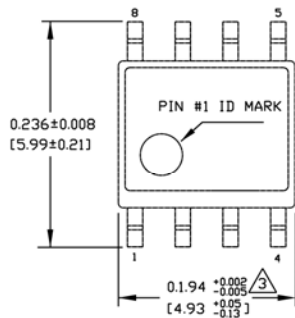

TOP VIEW

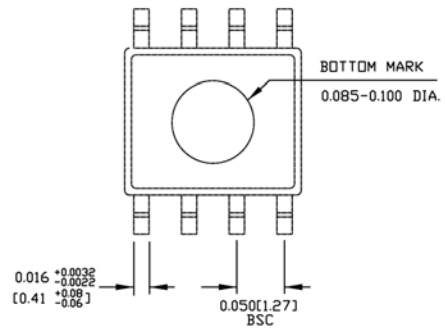

BOTTOM VIEW

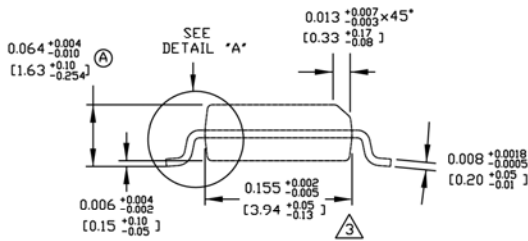

END VIEW

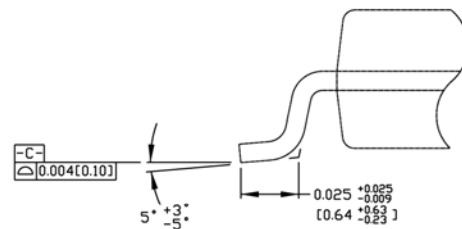

DETAIL "A"

- NOTES:**
1. DIMENSIONS ARE IN INCHES[MM].
  2. CONTROLLING DIMENSION: INCHES.
  3. DIMENSION DOES NOT INCLUDE MOLD FLASH OR PROTRUSIONS, EITHER OF WHICH SHALL NOT EXCEED 0.010[0.25] PER SIDE.

## 8-Pin SOIC (M)

**MICREL, INC. 2180 FORTUNE DRIVE SAN JOSE, CA 95131 USA**  
 TEL +1 (408) 944-0800 FAX +1 (408) 474-1000 WEB <http://www.micrel.com>

Micrel makes no representations or warranties with respect to the accuracy or completeness of the information furnished in this data sheet. This information is not intended as a warranty and Micrel does not assume responsibility for its use. Micrel reserves the right to change circuitry, specifications and descriptions at any time without notice. No license, whether express, implied, arising by estoppel or otherwise, to any intellectual property rights is granted by this document. Except as provided in Micrel's terms and conditions of sale for such products, Micrel assumes no liability whatsoever, and Micrel disclaims any express or implied warranty relating to the sale and/or use of Micrel products including liability or warranties relating to fitness for a particular purpose, merchantability, or infringement of any patent, copyright or other intellectual property right.

Micrel Products are not designed or authorized for use as components in life support appliances, devices or systems where malfunction of a product can reasonably be expected to result in personal injury. Life support devices or systems are devices or systems that (a) are intended for surgical implant into the body or (b) support or sustain life, and whose failure to perform can be reasonably expected to result in a significant injury to the user. A Purchaser's use or sale of Micrel Products for use in life support appliances, devices or systems is a Purchaser's own risk and Purchaser agrees to fully indemnify Micrel for any damages resulting from such use or sale.