

Starrett®

PRECISION TOOLS



CATALOGUE

www.starrett.com.sg • +65 6365 1088

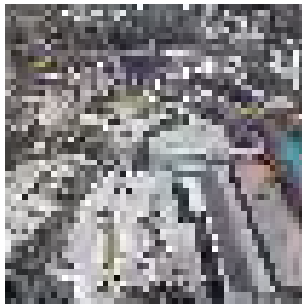

Athol, Massachusetts, USA



Laguna Hills, California, USA

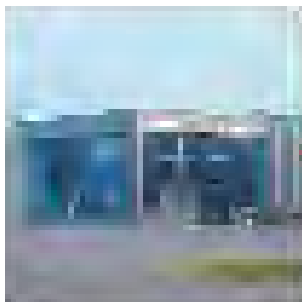

Waite Park, Minnesota, USA

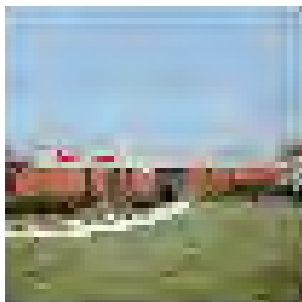

Cleveland, Ohio, USA

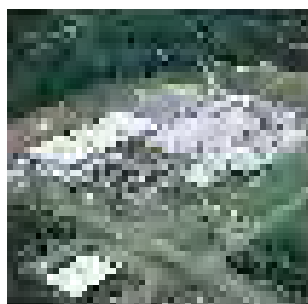

Mount Airy, North Carolina, USA



Santo Domingo, Dominican Republic



Toronto
Canada

Saltillo
Mexico

Schmitten
Germany

Buenos Aires
Argentina

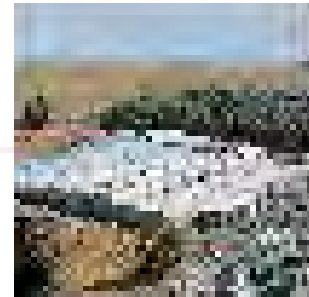
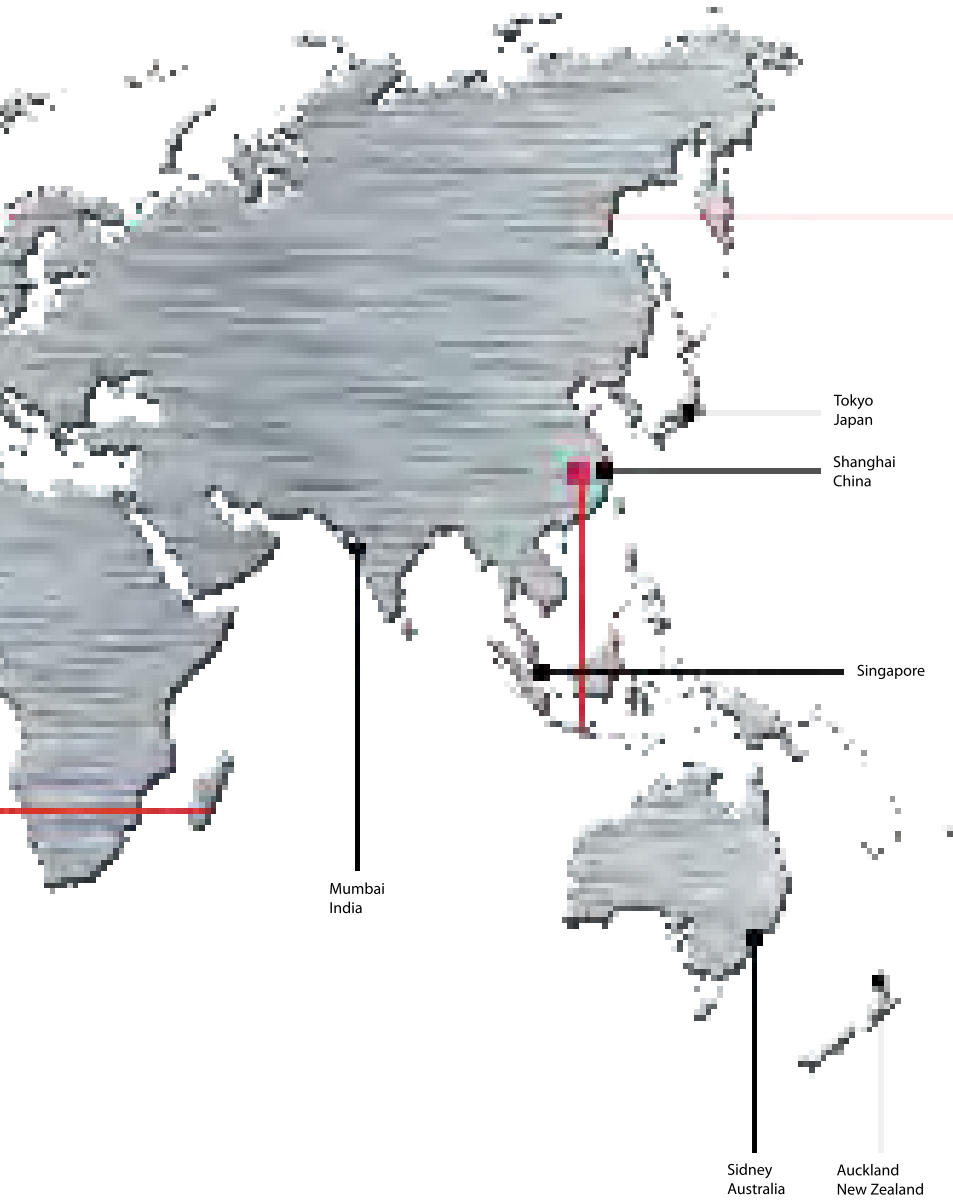

Jedburgh, Scotland



Suzhou, China



Itu, São Paulo, Brazil

- Starrett Distribution Centers and Offices
- Factories

The L.S. Starrett Company has been involved in precision tool manufacturing since 1880, sold products worldwide since the 1890s and introduced its first saw blade in about 1904.

Headquartered in Athol, MA since its founding, Starrett has a tradition and reputation so rich and solid that the words "quality" and "Starrett" have become synonymous.

The Company employs over 2,000 people worldwide with sales of over \$200,000,000.



CALIPERS

- 6 IP67 Electronic Digital Calipers
- 6 Electronic Digital Calipers
- 6 Dial Calipers
- 6 Vernier Calipers
- 7 Long Range Calipers

DEPTH & HEIGHT GAUGES

- 7 Electronic Digital Height Gauges
- 7 Electronic Digital Depth Gauges & Accessories
- 8-9 ALTISSIMO® Electronic Digital Height Gauges

MICROMETERS & STAND

- 10 Electronic Digital Micrometers
- 10 IP67 Electronic Digital Micrometers
- 11 Standard Outside Micrometer With Thermal Insulated Cover
- 11 Standard Outside Micrometers
- 11 Micrometer Sets
- 11 Outside Micrometers With Interchangeable Anvils
- 12 Blade Type Micrometers
- 12 Disc Type Micrometers
- 12 Stainless Steel Can Seam Micrometers
- 13 Inside Micrometer
- 13 Electronic Digital Micrometer Heads
- 13 Micrometer Heads
- 13 Electronic Digital Depth Micrometer
- 13 Depth Micrometers
- 14 Solid-Rod Inside Micrometers
- 14 Tubular Inside Micrometers
- 19 Micrometer Stand

BORE GAUGES

- 14 ACCUBORE® Electronic Bore Gauges & Sets
- 15 3 Point Internal Bore Gauge Micrometers & Sets
- 15 Bore Gauge Sets
- 16 Dial Bore Gauges
- 16 Small Hole Gauges
- 16 Telescoping Gauges

INDICATORS & STANDS

- 17 Universal Back-Plunger Dial Indicators
- 18 IP67 Electronic Digital Indicators
- 18 Electronic Digital Indicators
- 18 Dial Indicators
- 18 Dial Test Indicators
- 19 Indicator Holders & Stands

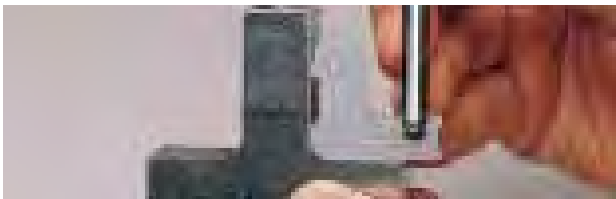

SQUARES, RULES & PARALLELS

- 20 Combination Sets With Square
- 20 Steel Rules
- 20 Precision Steel Squares
- 21 Adjustable Parallels

FIXED GAUGES

- 21 Feeler / Thickness Gauges
- 21 Screw Pitch Gauges
- 21-22 Taper Gauges
- 22 Radius Gauges
- 22-23 "Feeler Stock" Thickness Gauges

PRECISION SHOP TOOLS & LEVELS

- 23 Edge Finders
- 23 Bench Level
- 23 Machinists' Levels
- 23 Precision Level
- 24 Automatic Centre Punches
- 24 Long Range Drive Pin Punches
- 24 Centre Punches
- 24 Drive Pin Punches
- 25 Angle Meter
- 25 Tool & Instrument Oil
- 25 KLEENSCRIBE® Layout Dye
- 25 M1 Industrial Quality All Purpose Lubricant

GAUGE BLOCK SETS

- 27 Rectangular Steel Gauge Block Sets

MEASURING GAUGES & VIDEO SCOPES

- 17 Dial Thickness Gauges
- 26 Crankshaft Distortion Dial / Strain Gauge
- 26 Saw Tension Gauge
- 26 Pocket Laser Tachometer Kit
- 28 Video Borescopes

MATERIAL TESTING & SURFACE ROUGHNESS

- 29 Ultrasonic Thickness Gauge
- 29 Coating Thickness Gauge
- 30 Electronic Durometer
- 30 Digital Portable Hardness Tester
- 30 Portable Hardness Tester
- 31 Analogue Bench Hardness Tester
- 31 Twin Analogue Bench Hardness Tester
- 32 Digital Bench Hardness Tester
- 32-33 Test Blocks & Accessories For Hardness Testers
- 34-37 Surface Roughness Tester

798 SERIES - IP67 ELECTRONIC DIGITAL CALIPERS



798B-6/150



- IP67 level of protection against foreign matter.
- Instant inch/mm conversion.
- Fine adjustment thumb wheel.
- Large, easy to read LCD display.
- Hardened stainless steel measuring surface for long life.
- Zero the reading at any position.
- 798A Without data output.
- 798B With data output.



Cat No	Range	Graduation
798A-6/150	150mm / 6"	0.01mm / 0.0005"
798A-8/200	200mm / 8"	
798A-12/300	300mm / 12"	
798B-6/150	150mm / 6"	
798B-8/200	200mm / 8"	
798B-12/300	300mm / 12"	

799 SERIES - ELECTRONIC DIGITAL CALIPERS

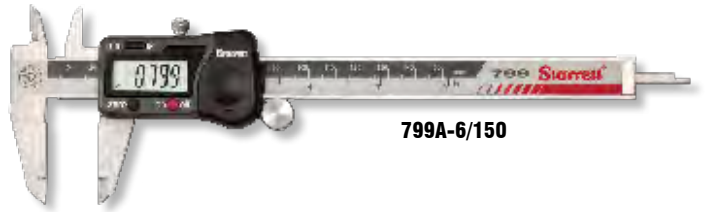

799A-6/150

- Instant inch/mm conversion.
- Zero the reading at any position.
- Fine adjustment thumb wheel.
- Lightweight, ergonomic design.
- Large, easy to read LCD display.



Cat No	Range	Graduation
799A-6/150	150mm / 6"	0.01mm / 0.0005"
799A-8/200	200mm / 8"	
799A-12/300	300mm / 12"	

125 SERIES - VERNIER CALIPERS

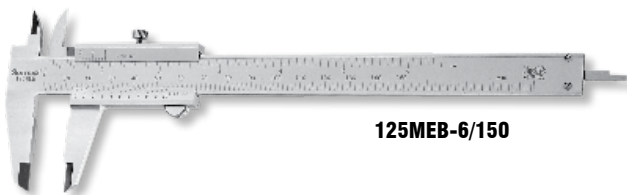

125MEB-6/150

- High quality basic vernier caliper.
- Lock screw for sliding jaw.
- Hardened stainless steel depth rod.
- Sharp, black graduations on the satin finished bar.

Cat No	Range	Graduation
125MEA-6/150	150mm / 6"	0.02mm / 0.001"
125MEA-8/200	200mm / 8"	
125MEA-12/300	300mm / 12"	
125MEB-6/150	150mm / 6"	0.05mm / 1/128"
125MEB-8/200	200mm / 8"	
125MEB-12/300	300mm / 12"	

1201 & 1202 SERIES - DIAL CALIPERS

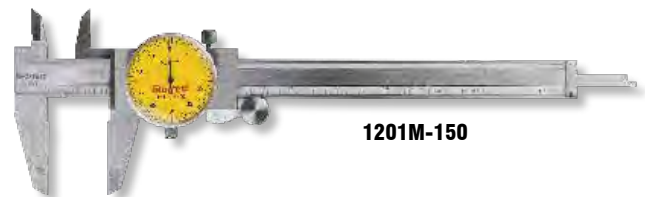

1201M-150

- Knife edge contacts for inside and outside measurements.
- Adjustable bezel.
- Lock screws for sliding jaw and dial bezel.
- Thumb-operated fine adjustment roll.

Cat No	Range	Graduation
1201M-150	150mm	0.01mm
1201M-200	200mm	
1202M-150	150mm	0.02mm
1202M-200	200mm	
1202M-300	300mm	
1202-4	4"	0.001"
1202-6	6"	
1202-8	8"	
1202-12	12"	

799 & 1251 SERIES - LONG RANGE CALIPERS

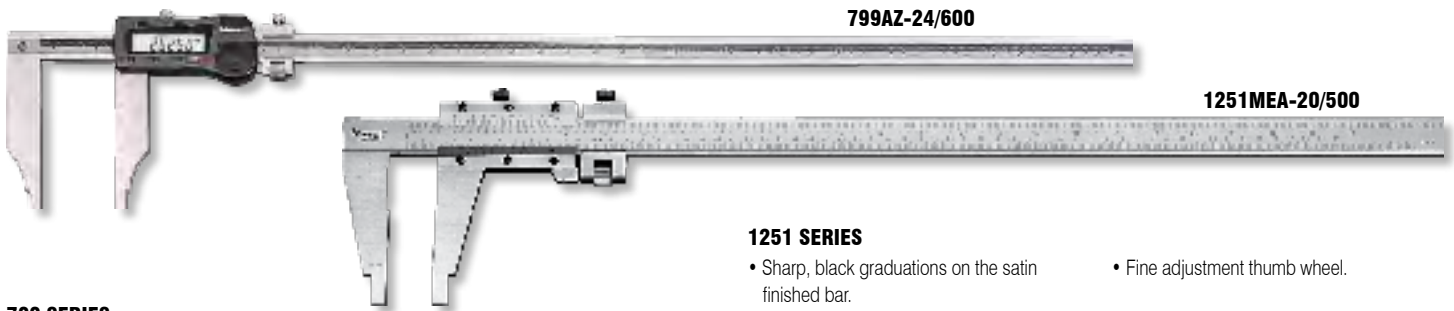

799 SERIES

- Instant inch/mm conversion.
- Zero the reading at any position.
- LCD characters are 13mm (1/2") high.
- Fine adjustment thumb wheel.

Cat No	Range	Graduation
799AZ-24/600	600mm / 24"	0.01mm / 0.0005"
799AZ-40/1000	1000mm / 40"	

799AZ-24/600

1251MEA-20/500

1251 SERIES

- Sharp, black graduations on the satin finished bar.
- Fine adjustment thumb wheel.

Cat No	Range	Graduation
1251MEA-12/300	300mm / 12"	0.02mm / 0.001"
1251MEA-20/500	500mm / 20"	
1251MEA-24/600	600mm / 24"	
1251MEA-40/1000	1000mm / 40"	

3753 SERIES - ELECTRONIC DIGITAL DEPTH GAUGES & ACCESSORIES



3753A-6/150

- Hardened stainless steel body and slide for long life.
- Hook attachment is furnished with the gauge, making it possible to take readings from the edge of the workpiece to edges of slots, grooves, shoulders and other ID length dimensioning.
- Fine adjustment thumb wheel.
- Sharp, easy to read LCD display.
- Lock to hold the slide in position.
- Instant inch/mm conversion.

Cat No	Range	Graduation / Description
3753AZ-6/150	150mm / 6"	0.01mm / 0.0005"
3753AZ-8/200	200mm / 8"	
3753AZ-12/300	300mm / 12"	
3648-180	180mm	Base Extension With Screws
3648-260	260mm	Base Extension With Screws
3648-320	320mm	Base Extension With Screws

ELECTRONIC DIGITAL HEIGHT GAUGES



3752-12/300

3751AZ-6/150

Starrett 3752 Electronic Height Gauge.

- Clear bar graduations in 5mm increments.
- Instant inch/mm conversion.
- Large LCD display.
- "Hold" control feature retains a reading at any position.
- Ability to retain and return to the true zero reading of the height gauge.
- With RS232 data output.

Starrett 3751 Electronic Height Gauge.

- Instant inch/mm conversion.
- Zero the reading at any position.
- Lock to hold slide in position.
- Vertical bar is back from the edge of the nose to provide better stability.
- Manual ON/OFF plus a built in automatic OFF after 5 minutes of non use.
- Without data output.

Cat No	Range	Graduation
3751AZ-6/150	150mm / 6"	0.01mm / 0.0005"
3752-12/300	300mm / 12"	
3752-24/600	600mm / 24"	

2000 SERIES - ALTISSIMO ELECTRONIC HEIGHT GAUGES

- A unique, ergonomically shaped base, hardened and ground, that fits your grip just right to easily move the gauge and press the "Hot Key".
- "Hot Key" allows you to select measuring results on the fly.
- 0 - 600mm (0 - 24") measuring range.
- Smart probe that can measure I.D. or O.D. without attachments.
- Electronically adjustable probe force.
- Large, easy-to-read interactive LCD with unique scanning meter for monitoring probe position.
- Electronically adjustable probe force.
- Electronically adjustable beeper volume.
- Bold screen icons indicate current routine.
- Three electronically adjustable resolutions.
- Retains the last calibrated diameter of the measuring probe, even after the gauge is shut down.
- Dynamic bi-directional probing with point and scan modes.
- Easy operation with speed wheel complete with fine-adjust feature.
- Locking mechanism for scribing.
- Five measurement modes: ID/OD, Centre, TIR, MAX/MIN, Continuous Display.
- Instant mm/inch conversion.
- Two selectable Datums and Preset.
- Auto Power Off after two hours with retention of probe calibration.
- Automatic calculation of eight measurement routines:
 - Centre.
 - Diameter.
 - Height.
 - Max.
 - Min.
 - TIR.
 - Distance to last feature.
 - Distance between last two points.
- Rechargeable NiMH batteries with 100 hours of continuous life.
- Optional probe kit features a variety of probes for many applications.
- Gauges include carbide probe, probe holder and probe calibration block.
- RS232 Data Output.
- Starrett capacitive measurement system ensures the accuracy and reliability you expect.
- Excellent value - loaded with features and competitively priced.

Technical Specifications	
Measuring Range	600mm (Extendible to 750mm by rotating the probe holder 180°)
Resolution	0.001mm / 0.01mm / 0.02mm
Accuracy	±0.008mm
Repeatability	±0.002mm
Power Source	NiMH Rechargeable Batteries (120V AC/60Hz Charger/Adaptor Included)
Included	4.8mm/0.1875" Diameter Carbide Probe, Probe Holder
Accessories	AC Charger/Adaptor, Probe Calibration Block
Dimensions	Length 279mm (11"), Width 197mm (7.3/4"), Height 927mm (36.1/2")
Weight	18Kgs / 40lbs
Perpendicularity	0.010mm (0.0004")



2000 SERIES - ALTISSIMO ELECTRONIC HEIGHT GAUGES



Large, easy-to-view /understand display shows the diameter of a hole or boss.



Display showing TIR.



Interactive LCD with unique scanning meter for easy probe position viewing.

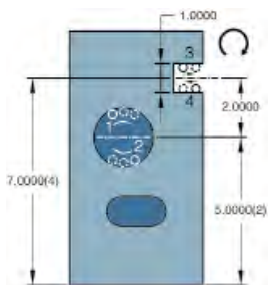

Altissimo includes many routines including diameter of a bore (1 & 2), width of a slot or a rib (3 & 4), distance from datum to center of a hole or slot and distance between features.

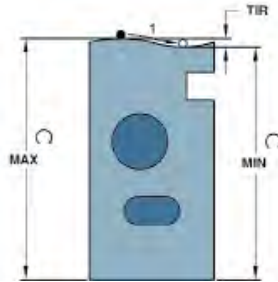

TIR mode can measure the high or low point of a diameter or other surface. The datum can then be set to the max or min value.

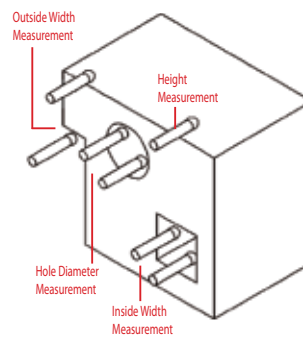

Cat No	Description
2000-24	Height Gauge
PT27937	Carbide Probe 4.8mm (0.1875") Diameter (Standard)
PT27940	Probe Holder (Standard)
PT27944	Probe Calibration Block (Standard)

Optional Accessories For Altissimo Height Gauges	
Cat No	Description
S2000AZ	Accessory Set Includes (All Items Marked With *):
PT27948	* Probe Tip, 5-Way Adaptor
PT23942	* 1mm (0.040") Carbide Contact Point
PT23914	* 2mm (0.078") Carbide Contact Point
PT23943	* 3mm (0.120") Carbide Contact Point
PT27952	* Contact Wrench
PT27945	* 10.2mm (0.400") Cylindrical Probe
PT27950	* Circular Carbide Probe
PT27949	* Depth Gauge Attachment
PT27946	* Holder For Dovetail Indicators
PT62011	Replacement Battery Pack, NiMH 6V
PT62015	Power Supply Charger For USA and Canadian Configuration
PT62130	Power Supply Charger For UK Configuration
PT62131	Power Supply Charger For European Configuration
PT61768	Interface Adaptor For Starrett Tools To PC
PT62103	Shielded Cable To Starrett 761/772 Series Starrett Modules & PT61768 Adaptor
PT62425	Computer Interface Cable To PC



3732 SERIES - ELECTRONIC DIGITAL MICROMETERS WITHOUT OUTPUT



- Instant inch/mm conversion.
- Zero the reading at any position.
- Starrett no-glare satin chrome finish on thimble and sleeve.
- Balanced, tapered frame for comfortable and accurate measuring.
- Micro-lapped carbide measuring faces.
- Auto OFF after 30 minutes of non-use.
- Extremely hard and stable one piece spindle, the heart of our accuracy and smooth operating one piece friction thimble.
- MEXFL - Thimble with mm scale.
- XFL - Thimble with imperial scale.
- Without data output.
- Sets available.

Cat No	Range	Graduation
3732MEXFL-25	0 - 25mm / 0 - 1"	0.001mm / 0.00005"
3732MEXFL-50	25 - 50mm / 1 - 2"	
3732MEXFL-75	50 - 75mm / 2 - 3"	
3732MEXFL-100	75 - 100mm / 3 - 4"	
3732MEXFL-125	100 - 125mm / 4 - 5"	
3732MEXFL-150	125 - 150mm / 5 - 6"	
3732XFL-1	0 - 1" / 0 - 25mm	0.00005" / 0.001mm
3732XFL-2	1 - 2" / 25 - 50mm	
3732XFL-3	2 - 3" / 50 - 75mm	
3732XFL-4	3 - 4" / 75 - 100mm	
3732XFL-5	4 - 5" / 100 - 125mm	
3732XFL-6	5 - 6" / 125 - 150mm	
S3732BXFLZ	0 - 4" / 0 - 100mm	0.00005" / 0.001mm
S3732CXFLZ	0 - 6" / 0 - 150mm	

795 / 796 SERIES - IP67 ELECTRONIC DIGITAL MICROMETERS



795MEXFL-25

- IP67 level of protection against coolant, water, dust and dirt.
- Instant inch/mm conversion.
- Zero the reading at any position.
- Starrett no-glare satin chrome finish on thimble and sleeve.
- Balanced, tapered frame for comfortable and accurate measuring.
- Micro-lapped carbide measuring faces.
- Extremely hard and stable one piece spindle, the heart of our accuracy and smooth operating one piece friction thimble.
- MEXFL - Thimble with mm scale.
- XRL - Thimble with imperial scale.
- 795 - With data output.
- 796 - Without data output.

Cat No	Range	Graduation
795MEXFL-25	0 - 25mm / 0 - 1"	0.001mm / 0.00005"
795MEXRL-50	25 - 50mm / 1 - 2"	
795MEXRL-75	50 - 75mm / 2 - 3"	
795MEXRL-100	75 - 100mm / 3 - 4"	
795XRL-1	0 - 1" / 0 - 25mm	
795XRL-2	1 - 2" / 25 - 50mm	0.00005" / 0.001mm
795XRL-3	2 - 3" / 50 - 75mm	
795XRL-4	3 - 4" / 75 - 100mm	
796MEXFL-25	0 - 25mm	0.001mm
796XRL-1	0 - 1"	0.00005"
796XRL-2	1 - 2"	
796XRL-3	2 - 3"	
796XRL-4	3 - 4"	

444 SERIES - OUTSIDE MICROMETERS WITH THERMAL INSULATED COVER

- Carbide measuring faces.
- Starrett satin chrome finish - no glare and rust resistant.
- Extremely hard and stable one piece spindle (the heart of our accuracy).
- Ring-type knurled lock nut for quick and sure locking.

Cat No	Range	Graduation
444MXRL-25	0 - 25mm	0.01mm
444MXRL-50	25 - 50mm	
444MXRL-75	50 - 75mm	
444MXRL-100	75 - 100mm	



444MXRL-25

436 SERIES - OUTSIDE MICROMETERS



- Carbide measuring faces.
- Starrett satin chrome finish - no glare and rust resistant.
- Extremely hard and stable one piece spindle (the heart of our accuracy).
- Ring-type knurled lock nut for quick and sure locking.

Cat No	Range	Graduation
436.2MXRL-25	0 - 25mm	0.01mm
436.1MXRL-50	25 - 50mm	
436.1MXRL-75	50 - 75mm	
436.1MXRL-100	75 - 100mm	
436.1MXRL-125	100 - 125mm	
436.1MXRL-150	125 - 150mm	
436MXRL-175	150 - 175mm	
436MXRL-200	175 - 200mm	
436MXRL-225	200 - 225mm	
436MXRL-250	225 - 250mm	
436MXRL-275	250 - 275mm	
436MXRL-300	275 - 300mm	
<hr/>		
436.1XRL-1	0 - 1"	0.001"
436.1XRL-2	1 - 2"	
436.1XRL-3	2 - 3"	
436.1XRL-4	3 - 4"	
436.1XRL-5	4 - 5"	
436.1XRL-6	5 - 6"	
436XRL-7	6 - 7"	
436XRL-8	7 - 8"	
436XRL-9	8 - 9"	
436XRL-10	9 - 10"	
436XRL-11	10 - 11"	
436XRL-12	11 - 12"	
<hr/>		
V436.2MXRL-25	0 - 25mm	0.001mm
V436.1MXRL-50	25 - 50mm	
<hr/>		
T436.1XRL-1	0 - 1"	0.0001"
T436.1XRL-2	1 - 2"	

S436 SERIES - MICROMETER SETS WITH STANDARDS



S436.2MCXRLZ

Cat No	Range	Graduation	Description
S436.2MCXRLZ	0 - 150mm	0.01mm	Each set includes: 25, 50, 75, 100, 125 & 150mm Micrometers, with Five Standards, in Case
S436.1CXRLZ	0 - 6"	0.001"	Each set includes: 1", 2", 3", 4", 5" & 6" Micrometers, with Five Standards, in Case

224 SERIES - OUTSIDE MICROMETERS WITH INTERCHANGEABLE ANVILS



224MARLZ

- Starrett satin chrome finish - no glare and resists rust.
- Advanced sleeve design with staggered lines and distinct figures for precise and easy readability.
- Large thimble diameter with distinct figures.

Cat No	Range	Graduation	Cat No	Range	Graduation
224MAARLZ	0 - 100mm	0.01mm	224AARLZ	0 - 4"	0.001"
224MARLZ	50 - 150mm		224ARLZ	2 - 6"	
224MGRLZ	150 - 300mm		224BRLZ	6 - 9"	
224MDRLZ	300 - 400mm		224GRLZ	6 - 12"	
224MERLZ	400 - 500mm		224CRLZ	9 - 12"	
224MJRLZ	500 - 600mm		224DRLZ	12 - 16"	
			224ERLZ	16 - 20"	
			224JRLZ	20 - 24"	

486 SERIES - BLADE TYPE MICROMETERS



- Non-rotating spindle prevents blade from turning in narrow slots or rolling off shoulder.
- Blade thickness is 0.8mm.
- Blades will measure to 8mm depths.
- Starrett satin chrome finish - no glare - resists rust.

Cat No	Range	Graduation
486MP-25	0 - 25mm	0.01mm
486MP-50	25 - 50mm	
486MP-75	50 - 75mm	
486MP-100	75 - 100mm	
486P-1	0 - 1"	0.001"
486P-2	1 - 2"	
486P-3	2 - 3"	
486P-4	3 - 4"	

256 SERIES - DISC TYPE MICROMETERS



- Extremely hard and stable one piece spindle (the heart of our accuracy).
- Tapered frame designed specifically for use in narrow slots and tight places.
- Balanced frame and thimble design insure easy handling and better readability.
- Micro lapped measuring faces.

Cat No	Range	Graduation
256MRL-25	0 - 25mm	0.01mm
256MPN-25*		
256MRL-50		
256MRL-75	25 - 50mm	0.01mm
256MRL-1	0 - 1"	
256PN-1*		
256RL-2	1 - 2"	0.001"
256RL-3	2 - 3"	

* Non-Rotating Spindle

207 SERIES - STAINLESS STEEL CAN SEAM MICROMETERS



- Designed to measure the thickness and depth of can seams.
- Satin finish stainless steel - no glare - rust and stain resistant.
- Advanced sleeve design with staggered lines and distinct figures for precise and easy readability.
- The No. 207 Series has a snub nose which permits measuring aerosol type cans.
- Extremely hard and stable one piece spindle (the heart of our accuracy).

Cat No	Range	Graduation
207MZ	0 - 9.5mm	0.01mm
207Z	0 - 0.375"	0.001"

208 SERIES - STAINLESS STEEL CAN SEAM MICROMETERS

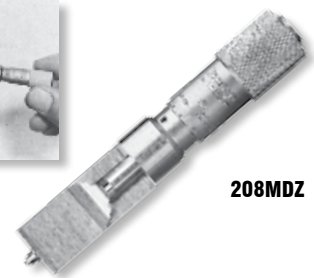

208MDZ

- Designed to measure the thickness and depth of can seams.
- Satin finish stainless steel - no glare - rust and stain resistant.
- Advanced sleeve design with staggered lines and distinct figures for precise and easy readability.
- Quick and easy adjustment.
- Extremely hard and stable one piece spindle (the heart of our accuracy).

Cat No	Range	Graduation	Description
208MZ	0 - 9.5mm	0.01mm	Without Depth Gauge
208MDZ			With Depth Gauge
208Z	0 - 0.375"	0.001"	Without Depth Gauge
208DZ			With Depth Gauge

700 SERIES - INSIDE MICROMETER

Cat No	Range	Graduation
700MA	5 - 30mm	0.01mm
700MB	25 - 50mm	
700A	0.200 - 1.200"	0.001"
700B	1 - 2"	

- Friction thimble.

- Lock screw.



762 SERIES - ELECTRONIC DIGITAL MICROMETER HEADS



- Instant inch/mm conversion.
- Carbide measuring faces.
- Ability to zero reading at any position.
- With data output.
- Friction thimble and lock nut.
- MEXFL - Thimble with mm scale.
- XFL - Thimble with imperial scale.

Cat No	Range	Graduation
762MEXFL-25	0 - 25mm / 0 - 1"	0.001mm / 0.00005"
762MEXFL-50	25 - 50mm / 1 - 2"	
762XFL-1	0 - 1" / 0 - 25mm	0.00005" / 0.001mm
762XFL-2	1 - 2" / 25 - 50mm	

749 SERIES - ELECTRONIC DIGITAL DEPTH MICROMETER



- Adjustable measuring rods are 4mm (5/32") in diameter.
- Instant inch/mm conversion.
- Ability to zero the reading at any position.
- Large, high contrast LCD digital readout.
- With data output.
- Ratchet stop and lock nut.
- MEBZ - Thimble with mm scale.
- BZ - Thimble with imperial scale.

Cat No	Range	Graduation	Base
749MEBZ-150	0 - 150mm / 0 - 6"	0.001mm / 0.0001"	100mm (4")
749BZ-6RL	0 - 6" / 0 - 150mm	0.0001" / 0.001mm	

MICROMETER HEADS



460 SERIES

These are plain micrometer heads with no lock nut or ratchet.



263 SERIES

- RL - Ratchet stop and lock nut.
- P - Plain head, no nut or ratchet.

Cat No	Range	Graduation
460MB	0 - 13mm	0.01mm
460B	0 - 1/2"	0.001"
463MRL	0 - 13mm	0.01mm
463RL	0 - 1/2"	0.001"
263MP*	0 - 25mm	0.01mm
263MRL*		
263P	0 - 1"	0.001"
263RL		
63MRL*	0 - 50mm	0.01mm
63P	0 - 2"	0.001"
63RL		

* 0 - 25mm models specify clamping diameter 12 or 12.7mm. 12.7mm sent unless otherwise ordered.

440 & 445 SERIES - DEPTH MICROMETERS

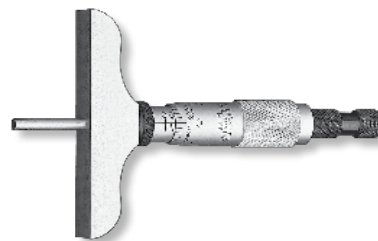

- Ring-type lock nut for quick and sure locking.
- Combination ratchet and speeder for uniform pressure and quicker adjustment.
- Ratchet stop and lock nut.
- 440 are finished with 63mm (2.1/2") base and 3.2mm (1/8") diameter measuring rods.
- 445 are finished with 100mm (4") base and 4mm (5/32") diameter measuring rods.

Cat No	Range	Graduation	No Of Rods
440MZ-75RL	0 - 75mm	0.01mm	3
440MZ-150RL	0 - 150mm		6
440MZ-225RL	0 - 225mm		9
440Z-3RL	0 - 3"	0.001"	3
440Z-6RL	0 - 6"		6
440Z-9RL	0 - 9"		9
445MBZ-75RL	0 - 75mm	0.01mm	3
445MBZ-150RL	0 - 150mm		6
445MBZ-225RL	0 - 225mm		9

124 SERIES - SOLID-ROD INSIDE MICROMETERS



124MBZ

Measuring I.D. with micrometer and rod.



- Rod diameters are approximately 6mm (1/4") on the A and B sizes, and approximately 8.5mm (11/32") on the C size.
- Hardened and ground anvils on rods, adjustable for length. Head anvil is hardened and ground.
- Each rod marked with length.
- Rods are insulated.
- Measuring rods are solid and assembled on one side of the micrometer head.
- Quick-reading figures - every thousandth numbered on inch reading tools.

Cat No	Range	Graduation	No Of Measuring Rods
124MAZ	50 - 200mm	0.01mm	6
124MBZ	50 - 300mm		10
124MCZ	200 - 800mm		4
124AZ	2 - 8"	0.001"	6
124BZ	2 - 12"		10
124CZ	8 - 32"		4

823 SERIES - TUBULAR INSIDE MICROMETERS



823MAZ



- 140mm long, convenient handle included on A and B micrometers may be clamped where it will provide correct balance and reach.
- Interchangeable anvils on 13mm and 25mm heads.
- Each rod is marked with length.
- Tubular measuring rods are lightweight, yet extremely rigid.
- Both the adjustable anvils on rods and the head anvil are hardened and ground.
- Lock nut included with 25mm heads.

Cat No	Range	Graduation	Description
823MAZ	40 - 200mm	0.01mm	With 6 Rods & Handle
823MBZ	40 - 300mm		With 8 Rods & Handle
823MEZ	100 - 1000mm		With 10 Rods
823AZ	1.1/2 - 8"	0.001"	With 5 Rods & Handle
823BZ	1.1/2 - 12"		With 8 Rods & Handle
823CZ	4 - 24"		With 7 Rods

781 SERIES - ACCUBORE® ELECTRONIC BORE GAUGES & SETS



AccuBore® is a high quality, trigger-activated, three-point contact bore gauging system with extended range. Its convenient single-hand operation provides speed and control. Squeeze the trigger, insert the gauge into the bore and release the trigger for an instant reading.

- Convenient "Go/No Go" tolerance indicator lights.
- Instant inch/mm conversion.
- HOLD, MAX/MIN and ZERO capabilities.
- With data output.
- Specialised heads available upon request.
- True alignment with mechanically-driven parallel anvils.

Cat No	Range	Approx Measuring Depth	Accuracy
781XTZ-500	10 - 12.5mm / 3/8 - 1/2"	58mm / 2.1/4"	0.004mm / 0.00015"
781XTZ-625	12.5 - 16mm / 1/2 - 5/8"	62mm / 2.3/8"	
781XTZ-750	16 - 20mm / 5/8 - 3/4"	66mm / 2.5/8"	
781XTZ-1	20 - 25mm / 3/4 - 1"		
781XTZ-138	25 - 35mm / 1 - 1.3/8"	80mm / 3.1/16"	0.005mm / 0.0002"
781XTZ-2	35 - 50mm / 1.3/8 - 2"		
781XTZ-258	50 - 65mm / 2 - 2.5/8"		
781XTZ-314	65 - 80mm / 2.5/8 - 3.1/4"	85mm / 3.3/8"	
781XTZ-4	80 - 100mm / 3.1/4 - 4"		

Cat No	Range	No of Heads	No of Rings
S781XTHZ	6 - 20mm / 0.250 - 0.750"	5	3
S781XTDZ	10 - 20mm / 0.375 - 0.750"	3	2
S781XTEZ	20 - 50mm / 0.750 - 2"	3	3
S781XTJZ	20 - 100mm / 0.750 - 4"	6	4
S781XTFZ	50 - 100mm / 2 - 4"	3	2

78 SERIES - 3 POINT INTERNAL BORE GAUGE MICROMETERS

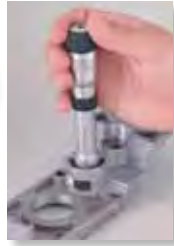

- 3-Point contact with carbide measuring faces on all 3-point heads above 12.5mm (1/2").
- Ratchet stop ensures consistent measurements.
- Self-centering contacts for true readings.
- Complete with setting ring.

Cat No	Range	Graduation	Approx Measuring Depth
78MXTZ-12.5	10 - 12.5mm	0.005mm	58mm
78MXTZ-16	12.5 - 16mm		62mm
78MXTZ-20	16 - 20mm		66mm
78MXTZ-25	20 - 25mm		80mm
78MXTZ-35	25 - 35mm		100mm
78MXTZ-50	35 - 50mm		115mm
78MXTZ-65	50 - 65mm		
78MXTZ-80	65 - 80mm		
78MXTZ-100	80 - 100mm		
78MXTZ-125	100 - 125mm		
78MXTZ-150	125 - 150mm		
78MXTZ-175	150 - 175mm		
78MXTZ-200	175 - 200mm		

Cat No	Range	No. of Heads	No. of Rings
S78MXT CZ	6 - 10mm	2	1
S78MXT DZ	10 - 20mm	3	2
S78MXT EZ	20 - 50mm		
S78MXT FZ	50 - 100mm		

Cat No	Range	Graduation	Approx Measuring Depth
78XTZ-500	3/8 - 1/2"	0.00025"	2.1/4"
78XTZ-625	1/2 - 5/8"		2.7/16"
78XTZ-750	5/8 - 3/4"		2.5/8"
78XTZ-1	3/4 - 1"		3.1/16"
78XTZ-138	1 - 1.3/8"		4"
78XTZ-2	1.3/8 - 2"		4.1/2"
78XTZ-258	2 - 2.5/8"		
78XTZ-314	2.5/8 - 3.1/4"		
78XTZ-4	3.1/4 - 4"		
78XTZ-5	4 - 5"		
78XTZ-6	5 - 6"		
78XTZ-7	6 - 7"		
78XTZ-8	7 - 8"		

Cat No	Range	No. of Heads	No. of Rings
S78XT CZ	1/4 - 3/8"	2	1
S78XT DZ	3/8 - 3/4"	3	2
S78XT EZ	3/4 - 2"		
S78XT FZ	2 - 4"		

3089 SERIES - BORE GAUGE SETS

3089M-181-160J



METRIC BORE GAUGE SET

- Carbide Tipped Anvil.
- Ergonomic design with non-slip insulating grip.
- All anvils laser marked for easy selection.
- 0.01mm graduated dial.
- 2 point contact.

Cat No	Range	Graduation
3089M-181-10J	6 - 10mm	0.01mm
3089M-181-18J	10 - 18mm	
3089M-181-35J	18 - 35mm	
3089M-181-50J	35 - 50mm	
3089M-181-160J	50 - 160mm	
3089M-181-250J	160 - 250mm	
3089M-181-450J	250 - 450mm	0.0005"
3089Z-131-715J	0.7 - 1.5"	
3089Z-131-1424J	1.4 - 2.4"	
3089Z-131-26J	2 - 6"	
S3089M-181-160J	Metric Bore Gauge Set, Set Contains, 3089M-181-35J, 50J & 160J	
S3089Z-131-6J	Imperial Bore Gauge Set, Set Contains, 3089Z-131-715J, 1424J & 26J	

82 SERIES - DIAL BORE GAUGES



- The split-ball contact is self-centering and the two-point contact makes the gage useful for detecting hole geometry problems like taper, bell-mouth and out-of-roundness.
- Reads to .0001" and 0.002mm.
- Useful for controlling approach to tolerance without removing the workpiece from a machine.
- Interchangeable probes are hard chrome plated and polished.
- Sets furnished in attractive, protective case.

Cat No	Range	Graduation	No of Probes
82MAZ	2.7 - 6.76mm	0.002mm	5
82MBZ	5.5 - 15.1mm		6
82MAB1	2.7 - 15.1mm	Head Only	
82AZ	0.107 - 0.266"	0.0001"	5
82BZ	0.217 - 0.594"		6
82AB1	0.107 - 0.594"		Head Only

Cat No	Range	Max Bore Depth
82A2	2.70 - 3.55mm / 0.107 - 0.140"	20.6mm / 13/16"
82A3	3.55 - 4.35mm / 0.139 - 0.172"	
82A4	4.35 - 5.15mm / 0.171 - 0.203"	
82A5	5.15 - 5.95mm / 0.202 - 0.234"	
82A6	5.90 - 6.76mm / 0.233 - 0.266"	
82B2	5.50 - 7.15mm / 0.217 - 0.281"	38mm / 1.1/2"
82B3	7.10 - 8.75mm / 0.279 - 0.344"	
82B4	8.70 - 10.30mm / 0.279 - 0.344"	
82B5	10.25 - 11.90mm / 0.342 - 0.469"	
82B6	11.90 - 13.50mm / 0.467 - 0.532"	44mm / 1.3/4"
82B7	13.50 - 15.10mm / 0.530 - 0.594"	

829 & 831 SERIES - SMALL HOLE GAUGES



S829EZ - Full Ball



S831EZ - Half Ball With Flat Bottom

- Hardened-ball measuring surface with two-point contact.
- Radius on each gauge is less than the minimum diameter to be measured, which provides the two-point contact necessary for maximum accuracy.
- Smooth, sensitive adjustment for better feel, giving more accurate measurements.
- The adjustment of the gauge beyond their range is restricted by a safety stop that prevents breakage.

Cat No	Description	Range	Length
S829EZ	Set of 4 in Case	3.2 - 5.1mm / 0.125 - 0.200"	75mm / 2.7/8"
		5.1 - 7.6mm / 0.200 - 0.300"	80mm / 3.1/8"
		7.6 - 10.2mm / 0.300 - 0.400"	85mm / 3.3/8"
		10.2 - 12.7mm / 0.400 - 0.500"	90mm / 3.1/2"
S831EZ	Set of 4 in Case	3.2 - 5.1mm / 0.125 - 0.200"	70mm / 2.13/16"
		5.1 - 7.6mm / 0.200 - 0.300"	80mm / 3.1/8"
		7.6 - 10.2mm / 0.300 - 0.400"	85mm / 3.3/8"
		10.2 - 12.7mm / 0.400 - 0.500"	90mm / 3.1/2"

579 SERIES - TELESCOPING GAUGES



Cat No	Description	Range	Handle Length
S579GZ	Set of 4 in Case	8 - 13mm / 5/16 - 1/2"	60mm / 2.3/8"
		13 - 19mm / 1/2 - 3/4"	
		19 - 32mm / 3/4 - 1.1/4"	
		32 - 54mm / 1.1/4 - 2.1/8"	
S579HZ	Set of 6 in Case	One of each of S579GZ plus two below	
		54 - 89mm / 2.1/8 - 3.1/2"	60mm / 2.3/8"
		89 - 150mm / 3.1/2 - 6"	82mm / 3.1/4"

196 SERIES - UNIVERSAL BACK-PLUNGER DIAL INDICATORS & ATTACHMENTS

Starrett 196 Series Indicators is one of the most versatile indicators available. The design has withstood the test of time. While there is a need for indicators with finer graduations, this indicator graduates to 0.02mm and 0.001" will handle by far the majority of jobs. Shank diameter is 6.3mm (1/4"). Antimagnetic models are also available.



A. Clamp
PT99437 With a 1-5/16" (33mm) flat or round capacity - 5/16" (8mm) post (PT03709-1/2) used with PT18718 Snug. (See right).

B. Tool Post Holder
PT99438 3/8" x 3/4" x 6" (9.5 x 19 x 150mm) with upright spindle (PT03820-0) 5/16" dia. x 4-1/2" length (8 x 114mm). Use with PT18718 Snug.

C. Snug Complete
PT18718 Post hole has a 5/16" diameter† and 3/32-1/4" holding capacity. Can be used on our 252 Height Transfer Gage, 57 and 257A and B Surface Gages, on 657A Magnetic Base and Swivel Post Assembly.

D. Snug Complete
PT18724 Post hole has a 3/8" diameter (9.5mm) and 3/32-1/4" (2.4-6.3mm) holding capacity. Can be used with our 57 and 257C and D Surface Gages or 657AA Magnetic Base with upright post.

E. Universal Snug
57S With spindle hole diameters 5/16", 3/8" (8, 9.5mm) and gripping hole diameters 9/64", 5/32", 3/16", 1/4" (3.5, 4, 4.8, 6.3mm).

F. Universal Snug
58S With spindle hole diameters 1/4", 5/16", 3/8" (6.3, 8, 9.5mm). Gripping hole diameters range from 3/32-1/4" used on holders with smaller clamp hole.

Attachments for 196 & 196M Series only

G. Hole Attachment
196F allows indicator be used over obstructions and inside holes to a depth of approximately 1-5/8" (40mm).

H. Shock Absorbing Anvil
PT08726A.

I. Split Bushing
PT00764 Allows attachment of 196 Indicator to 660 Magnetic Base.



Cat No	Graduation	Range	Dial Reading	Description
196MA1Z	0.02mm	5mm	0 - 100 (Yellow Dial)	Indicator With 3 Contact Points, Adaptor, 4 Attachments*, In Case
196MB1				Indicator With 3 Contact Points and Adaptor Only
196MA5Z			0 - 50 - 0 (Yellow Dial)	Indicator With 3 Contact Points, Adaptor 196R, 4 Attachments*, In Case
196MB5				Indicator With 3 Contact Points and Adaptor Only
196A1Z				Indicator With 3 Contact Points, Adaptor, 4 Attachments*, In Case
196B1	0.001"	0.200"	0 - 100	Indicator With 3 Contact Points and Adaptor Only
196A6Z				Antimagnetic Indicator With 3 Contact Points, 4 Attachments*, In Case
196B6			Antimagnetic Indicator With 3 Contact Points Only	
196A5Z			Indicator With 3 Contact Points, Adaptor, 4 Attachments*, In Case	
196B5			Indicator With 3 Contact Points and Adaptor Only	

* Attachments include Clamp, Tool Post Holder, Snug & Hole Attachment. For more detailed information, see Catalogue 32

Cat No	Photo Key	Description
196R	1	Adaptor **
196MR	1	Adaptor (Metric Threads)
PT05471	2	Hardened Steel Contact Point
PT05472	3	
PT05473	4	
PT99437	A*	Clamp
PT99438	B*	Tool Post Holder
PT18718	C*	Snug Complete
PT18724	D	Snug Complete - 1/4" & 3/8" Holes
57S	E	Universal Snug
58S	F	
196F	G*	Hole Attachment For 196 & 196M Series Only
PT08726A	H	Shock Absorbing Anvil For 196 & 196M Series Only
PT00764	I	Split Bushing For 196 & 196M Series Only

* Attachments marked with an asterisk (*) are furnished with all sets having "A" in the catalogue number.

** For Contact Points with #4-48 Thread, see AGD Contact Listings in Cat 32.

3015 SERIES - DIAL THICKNESS GAUGE



• 57mm dial face.

• Throat depth of 63mm (2.1/2").

Cat No	Range	Graduation	Throat Depth
3015MA	0 - 10mm	0.01mm	63mm
3015A	0 - 0.5"	0.001"	2.1/2"

2900 SERIES - IP67 ELECTRONIC DIGITAL INDICATORS



- IP67 protection against dirt, dust, water and coolant to withstand hostile shop environments.
- Data output on all models.
- Choice of Basic, Standard or Advanced feature levels.
- Selectable resolution models available.
- Instant mm/inch conversion.

Cat No	Range	Graduation
2900-1	0.5" / 12mm	0.00005" / 0.001mm
2900-4	0.5" / 12mm	0.0005" / 0.0001" / 0.00005" / 0.01mm / 0.001mm
2900-6	0.5" / 12mm	0.0005" / 0.0001" / 0.00005" / 0.01mm / 0.001mm

3600 SERIES - ELECTRONIC DIGITAL INDICATORS



- Large easy to read LCD display.
- AGD group 2 size.
- Range: 12.7mm or 0.500"
- Reverse travel (\pm control indicates direction).
- Zero setting at any position.
- 9.5mm diameter stem for mm/inch model (8mm on metric only model).
- Lug-on-centre-back + additional flat back.
- Dust cap.
- Long battery life.

Cat No	Range	Graduation
3600M-5	12.5mm	0.01mm
3600-5 *	12.5mm / 0.5"	0.01mm / 0.0005"

* 9.5mm (3/8") stem diameter.

DIAL INDICATORS



3025-481

- Supplied with tolerance hands and bezel lock.
- All indicators supplied with 57mm dial face, except for 3081-481 (43mm dial face).
- 3025 and 3081 Series Indicators supplied with long life jewel bearings and lug back.

Cat No	Range	Graduation	Dial Reading
25-151J-8	0.25mm	0.001mm	0 - 50 - 0
3025-257J	1mm		0 - 200
25-181J-8	2.5mm	0.01mm	0 - 50 - 0
3025-481/5	5mm		0 - 100
3081-481/5			
3025-481	10mm		0 - 100
3025-681	20mm		
25-2081J *	50mm		
25-3081J *	75mm		
25-4081J *	100mm		
25-5081J *	125mm		

* Complete with 9.5mm (3/8") stem diameter.

DIAL TEST INDICATORS



- Reversible contact point direction for versatility.
- Precision, gear driven design with smooth, jeweled movement.
- For extreme accuracy we recommend positioning the lever contact so that it is

approximately 15° from being horizontal with the workpiece.

Cat No	Range	Graduation	Dial Reading
3808MA	0.2mm	0.002mm	0 - 100 - 0
3809MA	0.8mm	0.01mm	0 - 40 - 0

MAGNETIC BASE INDICATOR HOLDERS, DIAL GAUGE STANDS & MICROMETER STAND



3657AA With Fine Adjustment



3657MTW Flex-O-Post Indicator Holder



653



653G

660 With Triple Jointed Arm & Fine Adjustment



661A Mini Magnetic Base & Indicator Holder



3206

Cat No	Dimensions	Height Total	Column
3657AA	63 x 55 x 50mm	230mm	Standard
3657MTW	380mm Vertical Reach 250mm Horizontal Reach	250mm	Flexible Post
660	40 x 35 x 30mm	190mm	3 Adjustable Pivots
661A	30mm Base Diameter	103mm	Mini Standard
Cat No	Description		
653	Comparator With Cast Iron Base, Without Indicator		
653G	Comparator with Grade A Crystal Pink Granite Base, Without Indicator		
Cat No	Capacity	Inclination	
3206	16mm / 5/8"	45°	

COMBINATION SETS WITH SQUARES

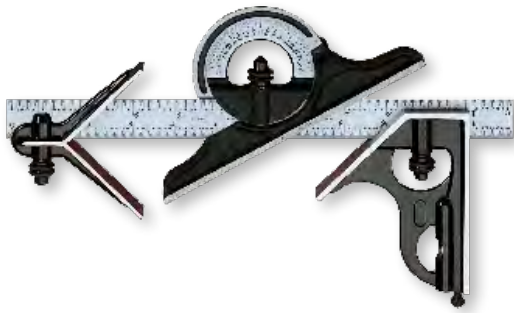

A complete substitute for a whole set of common solid try squares, a 45 degree mitre, a depth gauge, a height gauge, a marking or scribing gauge, a level, a plumb and by withdrawing the blade, it can also be used as a precision rule.

The Starrett 435 Series Combination Squares are the very best sets available, with reversible lock bolts, scriber, spirit level in both square head and protractor head, direct reading double 180° protractor scale, and a hardened steel, machine-divided blade.

Forged and hardened heads and centre heads, cast iron protractor head with smooth, black enamel finish.

Cat No	Range	Graduation
9M-300	300mm	mm & 1/2mm Both Sides
9M-600	600mm	
9ME-300	300mm / 11.3/4"	1/2mm & 32nds One Side mm & 64ths Reverse Side
9ME-600	600mm / 23.1/2"	
435ME-300	300mm / 11.3/4"	
435ME-600	600mm / 23.1/2"	
435-12-4R	12"	8ths, 16ths, Quick Reading, 32nds, 64ths
435-24-4R	24"	

635 SERIES - STEEL RULES



Spring Tempered With MM Graduations

Cat No	Length	Width x Thickness	Graduation
C635-150	150mm	19 x 1.2mm	mm & 1/2mm Both Sides
C635-300	300mm	25.4 x 1.2mm	
C635-500	500mm	29 x 1.2mm	
C635-1000	1000mm	32 x 1.2mm	

636 SERIES - STEEL RULES



Spring Tempered With MM/Inch Graduations

Cat No	Length	Width x Thickness	Graduation
C636ME-150	150mm / 5.3/4"	19 x 1.2mm	32nds & 1/2mm On One Side 64ths & mm On Reverse
C636-300	300mm / 11.3/4"	25.4 x 1.2mm	
C636-500	500mm / 19.1/2"	29 x 1.2mm	
C636-1000	1000mm / 39.1/4"	32 x 1.2mm	

PRECISION STEEL SQUARES

With Base



3020-6

Cat No	Specifications	Accuracy
3020M-75	75mm	0.005mm per 150mm of blade
3020M-100	100mm	
3020M-150	150mm	
3020M-300	300mm	
S3020MZ	Set Of 4 (One Of Each Size Listed Above)	
3020-3	3"	0.0002" per 6" of blade
3020-4	4"	
3020-6	6"	
3020-12	12"	

Plain - Without Base



60F-200

Cat No	Specifications	Accuracy
60F-75	75 x 50mm	0.005mm per 150mm of blade
60F-100	100 x 70mm	
60F-150	150 x 100mm	
60F-200	200 x 130mm	

Bevel - Without Base



60B-200

Cat No	Specifications	Accuracy
60B-50	50 x 40mm	0.005mm per 150mm of blade
60B-75	75 x 50mm	
60B-100	100 x 70mm	
60B-150	150 x 100mm	
60B-200	200 x 130mm	

154 SERIES - ADJUSTABLE PARALLELS



- Parallels slide smoothly and can be easily adjusted.
- All parallels are 7mm (9/32") thick.
- The smaller sizes A, B and C are locked by one screw while the larger sizes, D, E and F have two locks screws.

Cat No	Range	Length
154A	9.5mm - 12.7mm / 3/8" - 1/2"	45mm / 1.3/4"
154B	12.7mm - 17.5mm / 1/2" - 11/16"	55mm / 2.1/8"
154C	17.5mm - 24mm / 11/16" - 15/16"	70mm / 2.11/16"
154D	24mm - 33mm / 15/16" - 1.5/16"	90mm / 3.9/16"
154E	33 - 44mm / 1.5/16" - 1.3/4"	105mm / 4.3/16"
154F	44 - 57mm / 1.3/4" - 2.1/4"	130mm / 5.1/16"
S154SZ	Set Of 4 Parallels - Sizes A, B, C, D - In Case	
S154LZ	Set Of 6 Parallels - Sizes A, B, C, D, E, F - In Case	

FEELER / THICKNESS GAUGES



- 66MA and 467M Series - Straight Leaves.
- 173 and 66T Series - Tapered Leaves.

Cat No	Range	No of Leaves	Size of Leaves
66MA	0.05, 0.10, 0.15, 0.20, 0.25, 0.30, 0.35, 0.40, 0.45, 0.50, 0.55, 0.60, 0.65, 0.70, 0.75, 0.80, 0.85, 0.90, 0.95, 1.00mm	20	12.7 x 77mm
173MAT	0.03, 0.04, 0.05, 0.06, 0.07, 0.08, 0.09, 0.10, 0.15, 0.20, 0.30, 0.40, 0.50mm	13	12.7-7 x 77mm
173MCT			12.7-7 x 152mm
467M	0.04, 0.05, 0.06, 0.07, 0.08, 0.10, 0.15, 0.20, 0.30, 1.00, 2.00, 3.00, 5.00mm		12.7 x 114mm
66	0.0015", 0.002", 0.0025", 0.003", 0.004", 0.005", 0.006", 0.007", 0.008", 0.009", 0.010", 0.011", 0.012", 0.013", 0.014", 0.015", 0.016", 0.017", 0.018", 0.019", 0.020", 0.021", 0.022", 0.023", 0.024", 0.025"	26	1/2 x 3.1/32"
467	0.0015", 0.002", 0.003", 0.004", 0.006", 0.008", 0.010", 0.020", 0.030", 0.040", 0.075", 0.100", 0.200"	13	1/2 x 4.1/2"
66T	0.0015", 0.002", 0.0025", 0.003", 0.004", 0.005", 0.006", 0.007", 0.008", 0.009", 0.010", 0.011", 0.012", 0.013", 0.014", 0.015", 0.016", 0.017", 0.018", 0.019", 0.020", 0.021", 0.022", 0.023", 0.024", 0.025"	26	1/2-1.4" x 3.1/32"

SCREW PITCH GAUGES



International Metric Standard - 60° Threads

Cat No	Range of Pitches	No of Leaves	Pitches In MM
156M	0.25 - 2.50mm	28	0.25, 0.30, 0.35, 0.40, 0.45, 0.50, 0.55, 0.60, 0.65, 0.70, 0.75, 0.80, 0.85, 0.90, 1.1, 1.10, 1.20, 1.25, 1.30, 1.40, 1.50, 1.60, 1.70, 1.75, 1.80, 1.90, 2.2, 2.50
159M	0.5 - 11.5mm		0.5, 0.75, 1.1, 1.10, 1.25, 1.50, 1.75, 2.2, 2.50, 3.3, 5.0, 4, 4.50, 5.5, 5.0, 6.6, 5.0, 7.7, 5.0, 8.8, 5.0, 9.9, 5.0, 10, 10.50, 11, 11.50

Whitworth Standard - 55° Threads

Cat No	TPI Range	No of Leaves	Threads Per Inch (TPI)
476	3.1/2 - 60	30	3.1/2, 4, 4.1/2, 5, 6, 7, 8, 9, 10, 11, 12, 13, 14, 16, 18, 19, 20, 22, 24, 25, 26, 28, 30, 32, 36, 40, 44, 48, 50, 60

American National - 60° Threads

Cat No	TPI Range	No of Leaves	Threads Per Inch (TPI)
155	2.1/4 - 28	27	2.1/4, 2.3/8, 2.1/2, 2.5/8, 2.3/4, 2.7/8, 3.3/4, 3.1/2, 4.4, 4.1/2, 5.5, 1/2, 6.7, 8, 9, 10, 11, 12, 13, 14, 16, 18, 20, 24, 28
6	4 - 42	30	4.4, 1/2, 5.5, 1/2, 6.7, 8, 9, 10, 11, 11.1/2, 12, 12.13, 14, 15, 16, 18, 20, 22, 24, 26, 27, 28, 30, 32, 34, 36, 38, 40, 42
474	4 - 80	28	4.4, 1/2, 5.5, 6.7, 8, 9, 10, 11, 11.1/2, 12, 12.13, 14, 16, 18, 20, 24, 27, 28, 32, 36, 40, 44, 48, 56, 64, 72, 80
472	4 - 84	51	First Corner 17 Leaves: 4.4, 1/2, 5.5, 1/2, 6.7, 8, 9, 10, 11, 11.1/2, 12, 13, 14, 15, 16, 18 Second Corner 17 Leaves: 20, 22, 24, 26, 27, 28, 30, 32, 34, 36, 40, 42, 44, 46, 48, 50 Third Corner 17 Leaves: 52, 54, 56, 58, 60, 62, 64, 66, 68, 70, 72, 74, 76, 78, 80, 82, 84

270 SERIES - TAPER GAUGE



- The gauge is made of quality tool steel 11mm (7/16") wide by 160mm (6.1/4") long and is accurately tapered throughout its entire length for quick and convenient measuring of slot widths, etc.
- One side is graduated from 0.010" to 0.150" in thousandths of an inch and the reverse side from 0.3mm to 4mm in one-twentieth of a mm (0.05mm).

Cat No	Range	Graduation
270	0.3 - 4mm / 0.010 - 0.150"	0.05mm / 0.001"

269 SERIES - TAPER GAUGES



Cat No	Range	Graduation	Length	No of Leaves
269MA	2 - 12mm	0.02mm	64mm	10
269MB	12 - 25mm		70mm	13
269A	0.100 - 0.500"	0.001"	2.1/2"	8
269B	0.500 - 1"		2.3/4"	10

167 SERIES - RADIUS GAUGES

S167MCHZ



Cat No	Radii Range	Increments	No of Leaves
S167MCHZ	0.5 - 15mm	0.5mm - 1mm	22

272 SERIES - RADIUS GAUGES

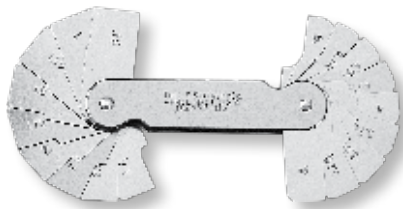

- An external and internal radius on each leaf permits both concave and convex surfaces to be measured.
- The leaves are specially shaped for use in any position at any angle to measure fillets and radii in corners or against shoulders.

Cat No	Radii Range	Increments	No of Leaves
272MA	0.75 - 5mm	0.25mm	18
272MB	5.5 - 13mm	0.5mm	16
272A	1/32 - 17/64"	64ths	
272B	9/32 - 33/64"		

667 SERIES - THICKNESS GAUGE "FEELER STOCK"



Metric gauges 300mm long.

Inch gauges 12" long.

Cat No	Thickness
667M-3	0.03mm
667M-4	0.04mm
667M-5	0.05mm
667M-6	0.06mm
667M-8	0.08mm
667M-10	0.10mm
667M-15	0.15mm
667M-20	0.20mm
667M-25	0.25mm
667M-30	0.30mm
667M-35	0.35mm
667M-40	0.40mm
667M-45	0.45mm
667M-50	0.50mm
667-1/2	0.0005"
667-1	0.001"
667-1.1/2	0.0015"
667-2	0.002"
667-2.1/2	0.0025"
667-3	0.003"
667-4	0.004"
667-5	0.005"
667-6	0.006"
667-7	0.007"
667-8	0.008"
667-9	0.009"
667-10	0.010"
667-11	0.011"
667-12	0.012"
667-13	0.013"
667-14	0.014"
667-15	0.015"
667-16	0.016"
667-17	0.017"
667-18	0.018"
667-19	0.019"
667-20	0.020"
667-21	0.021"
667-22	0.022"
667-23	0.023"
667-24	0.024"
667-25	0.025"
667-26	0.026"
667-27	0.027"
667-28	0.028"
667-29	0.029"
667-30	0.030"

666 SERIES - FEELER STOCK ROLL IN DISPENSER



Metric rolls 7.6M length.

Imperial rolls 25' length.

Cat No	Thickness
666M-3	0.03mm
666M-4	0.04mm
666M-5	0.05mm
666M-6	0.06mm
666M-8	0.08mm
666M-10	0.10mm
666M-15	0.15mm
666M-20	0.20mm
666M-25	0.25mm
666M-30	0.30mm
666M-35	0.35mm
666M-40	0.40mm
666M-45	0.45mm
666M-50	0.50mm
666-1	0.001"
666-1.1/2	0.0015"
666-2	0.002"
666-2.1/2	0.0025"
666-3	0.003"
666-4	0.004"
666-5	0.005"
666-6	0.006"
666-7	0.007"
666-8	0.008"
666-9	0.009"
666-10	0.010"
666-11	0.011"
666-12	0.012"
666-13	0.013"
666-14	0.014"
666-15	0.015"
666-16	0.016"
666-17	0.017"
666-18	0.018"
666-19	0.019"
666-20	0.020"
666-21	0.021"
666-22	0.022"
666-23	0.023"
666-24	0.024"
666-25	0.025"

827 SERIES - EDGE FINDERS



Cat No	Description	Body Diameter	Contact Diameter
827MA	Single End	10mm	6mm
827A		0.375"	0.200"
827MB	Double End	10mm	6mm & Pointed Contact
827B		0.500"	0.200" & Pointed Contact

130 SERIES - BENCH LEVEL



Cat No	Size	Description
130	85mm / 3.3/8"	With Main Vial

98 SERIES - MACHINISTS' LEVELS



98-6

Cat No	Size	Description
98-4	100mm / 4"	Without Cross Test Vial
98-6	150mm / 6"	With Cross Test Vial
98-8	200mm / 8"	
98-12	300mm / 12"	With Single Plumb Vial and Cross Test Vial
98-18	450mm / 18"	With Double Plumb Vial and Cross Test Vial

3097 SERIES - PRECISION LEVEL



- Main vials have seven graduations on each side of the bubble.
- Auxiliary level vial shows lateral position and assists in horizontal setting.
- Special alloy iron used to obtain freedom from thermal effects.
- One division equals 0.02mm/M or (0.0005") of an inch per foot.

Cat No	Length
3097Z	200mm

18 SERIES - AUTOMATIC CENTRE PUNCHES WITH ADJUSTABLE STROKE



18A

- These punches have a mechanism that automatically strikes a blow when downward pressure is applied.
- No hammer is required, making one hand always free to steady the work.

Cat No	Length	Diameter
18AA	100mm / 4"	11mm / 7/16"
18A	125mm / 5"	14mm / 9/16"
18C	130mm / 5.1/4"	17mm / 11/16"

117 SERIES - CENTRE PUNCHES



Cat No	Length	Diameter At Top Of Tapered Pt
117AA	75mm / 3"	1.5mm / 1/16"
117A	100mm / 4"	2mm / 5/64"
117B		2.5mm / 3/32"
117C		3mm / 1/8"
117D		4mm / 5/32"
117E	125mm / 5"	6.5mm / 1/4"
S117PC	Set Of 5 Punches - 117AA, A, B, C, D In Protective Case	

248 SERIES - LONG RANGE DRIVE PIN PUNCHES



- Long Range Drive Pin Punches are extra-long, measuring 200mm (8").
- The bodies are 115mm (4.1/2") and the drive pin sections are 90mm (3.1/2") long.

Cat No	Length	Diameter Punch
248A	200mm / 8"	1/8" (3mm)
248B		3/16" (5mm)
248C		1/4" (6mm)
248D		5/16" (8mm)
248E		3/8" (9.5mm)
S248PC	Set of 5 Punches (1 of each size) in Protective Vinyl Case	

565 SERIES - DRIVE PIN PUNCHES



Cat No	Length	Diameter Punch
565A	4" (100mm)	1/16" (1.5mm)
565B		3/32" (2.5mm)
565C		1/8" (3mm)
565D		5/32" (4mm)
565E		3/16" (5mm)
565F		7/32" (5.5mm)
565G		1/4" (6mm)
565H		5/16" (8mm)
S565WB	Set of 8 Punches (1 of each size) in Red Round Plastic Box	

AM-2 - ANGLE METER



- Large, readable scale for accurate readings from 0-90° in any quadrant.
- Magnetic base frees hands when used on ferrous surfaces.
- Measures any angle for pitch or slope.
- Handy rise, run, angle and pitch information on back of tool.

Cat No	Dimensions
AM-2	125 x 125mm

1610 SERIES - KLENSCRIBE LAYOUT DYE



- Deep, opaque blue makes lines stand out sharp and clear.
- Dries quickly, does not flake.

Cat No	Capacity
1610-4	4 oz (0.1 Litre)

1620 SERIES - TOOL & INSTRUMENT OIL



- Protects precision measuring tools and instruments.

Cat No	Capacity
1620	110ml



M1 SERIES - INDUSTRIAL QUALITY ALL PURPOSE LUBRICANT

- **Prevents Rust:** Protects metal against rust and corrosion damage by providing a molecular shield that locks to the metal.
- **Penetrates:** Deep-down penetration works quickly to free frozen nuts, bolts and metal parts.
- **Lubricates:** M1 is free of silicone, making it an excellent lubricant. Its ability to stand up to extreme temperatures makes it ideal all year round.
- **Cleans:** Removes grease, tar and grime from metal parts and painted surfaces. Cleans and polishes for lasting protection.
- **Displaces Moisture:** M1 is not soluble in water, therefore it gets under moisture to lift it away from the surface to be protected.



Description
200ml Aerosol Can
400ml Aerosol Can

696 SERIES - CRANKSHAFT DISTORTION DIAL / STRAIN GAUGE

An ideal gauge for checking bearing alignment or shaft deflection without dismantling the engine. Used on all diesel engine shafts and the centre crankshafts on any type of engine or compressor, the gauge can also be applied as a strain gauge on engine frames while the engine is operating.

Cat No	Range	Graduation
696MZ	61 - 458mm	0.02mm
696Z	2,3/8 - 18"	0.001"

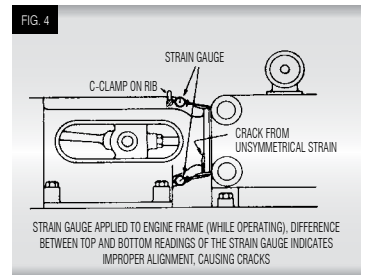
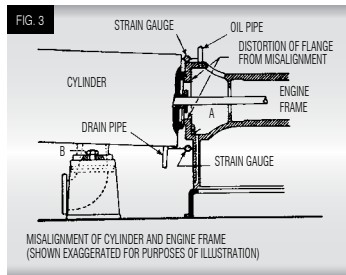
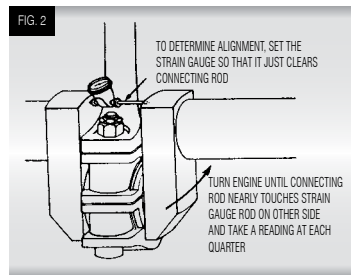
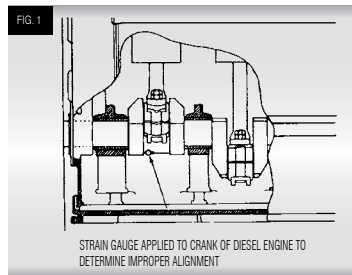

682 SERIES - SAW TENSION GAUGE

The Starrett Saw Tension Gauge will check for proper blade tension in either English or metric and is graduated both in pounds and kilograms.

The tension gauge can be read directly on either band saws of any type, or power hacksaws. It is graduated to read up to 60,000 PSI or 4,000kg per cm² and is furnished with instructions, including suggested tensions.

Cat No	Description
682EMZ	Saw Tension Gauge



7793 SERIES - POCKET LASER TACHOMETER KIT

The Pocket Laser Tachometer is a digital, battery operated portable optical tachometer that can operate up to 25 feet from a reflective target using a laser light source.

The powerful 32 function Tachometer/Ratemeter, Totaliser/Counter and Timer is programmable in both inch and metric rates. It has TTL compatible pulse output to trigger devices such as data collectors or stroboscopes.

Ergonomic design makes measurement of speed and RPM simple.

Cat No	Range		Accuracy	
	Optical (RPM)	Contact (RPM)	Optical	Contact
S7793Z	5 to 200,000	0.5 to 20,000	±0.01% of Reading	±0.05% of Reading



RECTANGULAR STEEL GAUGE BLOCK SETS

- All gauge blocks are manufactured from a high grade steel.
- Etched, unique serial numbers are included on each block.
- Tolerance class for 0 and 1
 - ISO 3650.
- Tolerance class for B and W
 - Metric sets have a tolerance of $\pm 1.25 \mu\text{m}$.
 - Inch sets have a tolerance of $\pm 50 \mu\text{in}$.



Cat No	Tolerance Class	No of Blocks in Case	Nominal Size	Steps	Gauge Blocks
3047.0	0	47	1.0005mm	-	1
3047.1	1		1.01 through 1.19mm 1.2 through 1.9mm 1 through 10mm 20 through 100mm	0.01mm 0.1mm 1mm 10mm	19 8 10 9
3088.0	0	88	1.0005mm	-	1
3088.1	1		1.001 through 1.009mm	0.001mm	9
			1.01 through 1.49mm	0.01mm	49
			0.5 through 9.5mm 10 through 100mm	0.5mm 10mm	19 10
RS 88.MB	B	88	0.5mm	-	1
RS 88.MW	W		1.0005mm	-	1
			1.001 through 1.009mm	0.001mm	9
			1.01 through 1.49mm 1 through 9.5mm 10 through 100mm	0.01mm 0.5mm 10mm	49 18 10
RS 112.MB	B	112	0.5mm	-	1
RS 112.MW	W		1.0005mm	-	1
			1.001 through 1.009mm	0.001mm	9
			1.01 through 1.49mm 1 through 24.5mm 25 through 100mm	0.01mm 0.5mm 25mm	49 48 4
RS 81.B	B	81	0.1001" through 0.1009"	0.0001"	9
RS 81.W	W		0.101" through 0.149"	0.001"	49
			0.050" through 0.950" 1" through 4"	0.050" 1"	19 4

Cat No	Tolerance Class	Description
RS 81.B RS 88.MB RS 112.MB	B	Inch System (RS 81.B) uncertainty of measurement (k=2): $U = 6 + L$ where L is in inches, but U not less than 7 min. Metric Systems (RS 88.MB & RS 112.MB) uncertainty of measurement (k=2): $U = 0.15 + .001L$ where L is in millimeters, but U not less than 0.18 mm.
RS 81.W RS 88.MW RS 112.MW	W	Inch System (RS 81.W) uncertainty of measurement (k=2): 10 μin . Metric Systems (RS 88.MW & RS 112.MW) uncertainty of measurement (k=2): $U = 0.25 \mu\text{m}$.

698 & 699 SERIES - VIDEO BORESCOPIES



Starrett 698 and 699 Video Borescopes are ideal for inspection of inaccessible areas. Applications include viewing hard-to-see areas during machining operations, inspection of internal parts of engines and machinery, A/C systems and interior structures of walls.

- Camera has a tempered glass lens and durable, corrosion resistant stainless steel body.
- Flexible, water resistant conduit with high quality metal tip.
- Detachable 1m (39.4") conduit (other lengths available by special order).
- Bright LED illumination.
- High quality image.
- Camera IP67 and body IP65 protection against water, dirt and dust.



Model Specifications		699-5.5	699-10	698-10
Camera Probe	Diameter	5.5mm / 0.217"	10mm / 0.394"	10mm / 0.394"
	Focal Distance	20 - 70mm / 0.79 - 2.76"	30 - 60mm / 1.18 - 2.36"	30 - 60mm / 1.18 - 2.36"
	FOV	60° Diagonal		
	Resolution	720 x 480 (D1)	640 x 480 (VGA)	640 x 480 (VGA)
	Light Source	White LCD x4	White LCD x6	White LCD x6
	Material	Stainless Steel		
	IP Protection			
Conduit	Length, Type	1m / 39.4" Flexible	1m / 39.4" Gooseneck	1m / 39.4" Gooseneck
Temperature	Operating	0 - 50°C / 32° - 122°F		
	Storage	-10 - 60°C / 14° - 140°F		
Display	Size	89mm / 3.5" TFT		61mm / 2.4"
	Photo Res.	720 x 480 (D1) & 360 x 240 (CIF) Jpeg Format		N/A
	Video Res.	720 x 480 (D1) & 30fps@360 x 240 (CIF) Motion Jpeg, Vdec Recording 30fps AVI Playback		480(W) x 230(H)
Video Output	NTSC / PAL			
Memory	Micro SD Card Slot			N/A
Data Output	USB 2.0			N/A
Power Source	Power	4 x AA Batteries, 5V DC & 12V DC		4 x AA Batteries, 5V DC
	Charge Duration	3 Hours		4 Hours
Size & Weight	Weight	450gms / 1lb (excluding batteries)		
	Dimensions	L: 225mm (8.86"), W: 102mm (4.02"), H: 66mm (2.60")		
Accessories Included	Owner Manual, Video Output Cable, USB Cable, 2GB Micro SD Card, Case			Owner Manual, Video Output Cable, Case

Cat No	Description	Probe
699-5.5	Video Borescope, Manual, Video Output Cable, USB Cable, 45° Mirror, 2GB Micro SD Card, Case	5.5mm
699-10	Video Borescope, Manual, Video Output Cable, USB Cable, 2GB Micro SD Card, Case	10mm
698-10	Video Borescope, Manual, Video Output Cable, Case	10mm

3812 SERIES - ULTRASONIC THICKNESS GAUGE

Starrett 3812 Ultrasonic Thickness Gauge is a menu driven, multifunctional tester with basic measurement capabilities.

This gauge is designed to measure the thickness of metallic and non-metallic materials such as aluminium, titanium, plastics, ceramics, glass and any other good ultrasonic wave conductor, as long as it has parallel top and bottom surfaces. The 3812 will accurately display readings in either mm or inch after a simple calibration to a known thickness or sound velocity.

- Upper/Lower limit preset alarm.
- Measurement and scanning capabilities.
- Extended memory.
- 20 memory groups (100 files/group).
- Minimum display unit: 0.01mm (0.001") selectable.
- 0.040-12.0" measuring range (in steel with standard probe).
- 3280-32805ft/s (1000-9999m/s) sound velocity range.
- 5MHz Frequency.
- 4Hz update range.
- USB Output.
- Power supply: Two 3V AA alkaline batteries.
- Accuracy: $\pm (0.5\% \text{ thickness} + 0.001")$.
- Dimensions: 150 x 74 x 33mm.
- Weight: 245gms.



Cat No	Description
3812	Ultrasonic Thickness Gauge

3813 SERIES - COATING THICKNESS GAUGE

The 3813 is capable of measuring the thickness of non-magnetic materials, (paint, plastic, enamel, copper, zinc, aluminium and chrome) on magnetic materials.

It is often used to measure the thickness of a galvanized layer, lacquer, porcelain, phosphide, copper tile, aluminium tile and some alloy tiles, etc.

The 3813 is also capable of measuring the thickness of non-magnetic coatings on non-magnetic metals. It is used on anodizing, varnish, paint, enamel, plastic coatings and powder applied to aluminium, brass and non-magnetic stainless steel.

- Measuring range: 0-40mils (0-100 μ m) max.
- Resolution: 0.1 μ m/0.1mils (0-99 μ m) or 1 μ m (over 100 μ m).
- Guaranteed tolerance (after one-point calibration): $\pm 1-3\%n$ or 2 μ m (whichever is greater).
- Minimum measuring area: 5 x 5mm (0.20" x 0.20").
- Minimum radius of curvature:
Convex: 3mm (0.12");
Concave: 30mm (1.2").
- Minimum substrate thickness:
Ferrous: 0.5mm (20mils);
Non-ferrous: 50 μ m (2mils).
- Zero calibration.
- Foil calibration.
- Maximum surface temperature of test object: 302°F (maximum contact time two seconds).
- Power source: Four AA batteries.
- Includes steel and aluminium substrate samples.
- Includes four calibrated thickness samples.
- Dimensions: 161 x 69 x 32mm.
- Weight: 260gms.



Cat No	Description
3813	Coating Thickness Gauge

3805B SERIES - ELECTRONIC DUROMETER

Starrett 3805B measures Shore A values for a wide variety of soft materials including, rubber, soft vulcanised (i.e. tyre), natural nitrile, elastomeric materials (rubber and rubber-like) GR-S, GR-1, neoprene, thiokol, flexible polyacrylic esters. Other soft materials including wax, felt, leather etc.

- Extra large LED display.
- Simple 3 button control.
- Auto HOLD feature.
- Measuring range: 0-100 HSA.
- Deviation: <1% H.
- Resolution: 0.5 H.
- Accurate and repetitive deviation = 20~90 HSA.
- HSA <+/- 1grade.

Cat No	Description
3805B	Electronic Durometer in Plastic Case



3810A SERIES - DIGITAL PORTABLE HARDNESS TESTER

The Starrett 3810A is a state-of-the-art, digital instrument designed to test the hardness of large hard metal parts. Loaded with useful functions such as USB output and a built in printer, the 3810A is an ideal choice for fast accurate hardness testing.

This versatile tester can perform tests that easily convert to the most popular hardness scales, including Rockwell, Brinell, Vickers and Shore.

The tester is easy to use, simply load the impact body, place the impact body on your test piece then, push the button to begin testing.

The 3810A is designed to test large hard parts. For example, tool steel should be close to 1" thick of solid material. The 3810A comes with a D impact device, calibration block, cleaning brush, manual and carrying case.

- Accuracy: $\pm 0.5\%$ (referred to L=800).
- Repeatability accuracy: $\pm 4L$ units L=Leeb.
- Measuring range: 200-960 HL For steel and cast steel, alloy tool steel, stainless steel, gray cast iron, spheroidal iron, cast aluminium, brass, bronze, wrought copper alloy.
- Operating temperatures: 5-104°F
- Dimensions: 150 x 74 x 32mm (5.96" x 2.938" x 1.270").
- Weight: 245gms.
- Kit Includes: 3810A Tester, impact device D, calibration test block, cleaning brush, manual and custom carry case.
- Available options include DC, D+15, DL, G, C impact devices and special support rings.

Cat No	Description
3810A	Digital Portable Hardness Tester in Case



3811A SERIES - PORTABLE HARDNESS TESTER



The Starrett 3811A is a state-of-the-art, digital portable hardness tester. The 3811A is designed to test hardness of large hard metal parts.

The 3811A combines fast test speeds coupled with ample memory and output.

It performs tests that easily convert to most popular hardness scales such as Rockwell, Brinell, Vickers and Shore.

- Accuracy: $\pm 0.5\%$ (referred to L=800).
- Repeatability accuracy: $\pm 4L$ units L=Leeb.
- Measuring range: 200-960 HL For steel and cast steel, alloy tool steel, stainless steel, gray cast iron, spheroidal iron, cast aluminium, brass, bronze, wrought copper alloy. Tool steel should be 25.4mm (1") thick solid material or larger.
- Operating temperatures: 5-104°F
- Dimensions: 150 x 74 x 32mm (5.96" x 2.938" x 1.270").
- Weight: 245gms.

Cat No	Description
3811A	Portable Hardness Tester in Case

3814 SERIES - ANALOGUE BENCH HARDNESS TESTER

The 3814 Hardness Tester provides reliable Rockwell Hardness values on all types of metal and alloys, hard or soft and in many shapes. This reliable bench hardness tester has a high quality casting, is ergonomically designed for easy operation and is engineered to ensure accurate results.

It is an ideal basic hardness solution, economically priced to suit a variety of lab, workshop, toolroom and inspection department applications. The 3814 conforms to ASTM E-18 standard.

The tester is furnished with a diamond indenter, a 1.6mm (1/16") ball indenter, three certified test blocks, four test tables - 149mm (5.87") and 63.5mm (2.5") flat anvils, 15.9mm (5/8") spot anvil and a standard vee anvil and accessory case.

- Ability to handle Rockwell Scales A through H and K.
- Stable cast iron construction.
- Ideal basic hardness testing for many typical applications.



Technical Specifications	
Major Load	A: 60Kgf, B: 100Kgf, C: 150Kgf
Minor Load	10Kgf
Maximum Test Height	169.9mm (6.69")
Results Display	Analogue - Dial Gauge
Test Force Application	Dead Weight Applies Test Force
Test Force Control	Hydraulic Dashpot System
Throat Depth	168mm (6.6")
Unit Height / Width / Depth	762 x 216 x 508mm (30" x 8.5" x 20")

Cat No	Description
3814	Analogue Bench Hardness Tester

3815 SERIES - TWIN ANALOGUE BENCH HARDNESS TESTER

The Starrett 3815 Twin Analogue Hardness Tester features state-of-the-art design and rugged construction. It is engineered to provide highly sensitive, accurate readings and excellent repeatability in all Rockwell and Superficial Rockwell hardness scales.

The 3815 is ideal for heat treatment facilities, tool rooms, workshops, laboratories and inspection labs.



- Direct analogue dial reading.
- Advanced design provides Rockwell and Rockwell Superficial testing.
- Engineered to provide highly sensitive and accurate readings.
- Conforms to ASTM E-18.
- Tests Rockwell Scales: A, B, C, D, E, F, G, H, K, L, M.
- Tests Superficial Rockwell Scales: HR15N, HR15T, HR30N, HR30T, HR45N, HR45Ts.
- Includes a diamond conical indenter, 1/16" ball indenter, HRC, HRB, HR15N, HR30N and HR45T test blocks, 150mm (5.87") test table, 63mm (2.5") flat anvil, standard vee anvil, accessory case and dust cover.

Cat No	Description
3815	Twin Analogue Bench Hardness Tester

Technical Specifications	
Major Load	60Kgf / 100Kgf / 150Kgf
Minor Load	10Kgf Minor Load - Superficial 3Kgf
Maximum Test Height	15.2mm (6.0")
Results Display	Dual Scale Dial
Test Force Application	Dead Weight
Test Force Control	Manual
Throat Depth	14mm (5.5")
Unit Height / Width / Depth	66 x 46.2 x 23.9mm (26" x 18.2" x 9.4")
Unit Weight	113Kgs

3816 SERIES - DIGITAL BENCH HARDNESS TESTER

The microprocessor controlled 3816 Bench Hardness Tester offers easy, fully automated testing procedures and provides highly sensitive and accurate readings.

The 3816 can measure the full regular Rockwell Scales according to ASTM and SAE guidelines. It accommodates all types of hard or soft metals and alloys, in numerous configurations. Overall, the 3816 is packed with features and provides excellent value.

The tester is furnished with a diamond indenter, a 1.6mm (1/16") ball indenter, three certified test blocks, four test tables - 149mm (5.87") and 63.5mm (2.5") flat anvils, 15.9mm (5/8") spot anvil and a standard vee anvil, and an accessory case.

- Automated routines reduce operator involvement and speed measurements.
- Large, easy-to-view LED panel displays proper load setting.
- Programmable scale conversions, dwell times and tester counting.
- Sample averaging is automatically calculated.
- With data output.
- Convenient mini-printer for outputting readings.



Technical Specifications	
Major Load	A: 60Kgf, B: 100Kgf, C: 150Kgf
Minor Load	10Kgf
Maximum Test Height	169.9mm (6.69")
Results Display	Digital Readout
Test Force Application	Dead Weight Applies Test Force
Test Force Control	Motorised
Throat Depth	168mm (6.6")
Unit Height / Width / Depth	711 x 226 x 498mm (28" x 8.9" x 19.6")
Unit Weight	85Kgs

Cat No	Description
3816	Digital Bench Hardness Tester

TEST BLOCKS & ACCESSORIES FOR HARDNESS TESTERS

Starrett blocks can be used to test Rockwell, Brinell or Vickers scales. They are available in steel, brass and aluminum. Each block is serialized, with a certificate detailing the environmental conditions used to test the block.

Actual readings are given, with the averages of these readings: min. reading, max reading and a repeatability figure. The blocks are calibrated according to ASTM E-18 standards, ANSI (NCSL) Z540-1, (ISO) 10012-1, ISO/IEC 17025 and Mil-std 45662A.

Starrett hardness test blocks are manufactured from square steel or brass plates, as opposed to the more common round bar stock. The use of plate gives a more accurate and consistent surface for inspection. Metallurgical tests have proved that during the production of round bar stock, suspended carbides in the mix migrate to the center of the rod.

The scientific name for this condition is carbide segregation and results in different readings being found in the center of a rod rather than at its outer edges. Some manufacturers remedy this situation by removing the centers from their blocks.

Hardness test blocks are designed to be used only on one side and the indents should be more than .010" from the centers of two indents or no closer to the block's edge than .040".

Calibration kits are also available from Starrett. No facility with a hardness tester in use should be without a calibration kit. These kits come with from 3 to 20 calibrated test blocks and the serialized penetrator that was used to inspect each of the blocks in the set. When a discrepancy is detected in a tester, these kits allow you to determine the direction to proceed to resolve the issue.



PT05272 HRC 3-Block Master Calibration Kit

Cat No	Description
PT05272	HRC 3-Block Master Calibration Kit
PT05273	HR30N 3-Block Master Calibration Kit
PT05276	HRB 3-Block Master Calibration Kit
PT05277	C&B Scale 20-Block Master Calibration Kit
PT05278	C&30N Scale 6-Block Master Calibration Kit

TEST BLOCKS & ACCESSORIES FOR HARDNESS TESTERS

Variety of Rockwell and Brinell test blocks at a variety of hardness levels. (A) Aluminum Brinell, (B) Steel Brinell, (C) Vickers, (D) Rockwell, (E) 187.5kg./2.5mm Brinell, (F) Extra-Soft Rockwell and (G) Brass Rockwell.

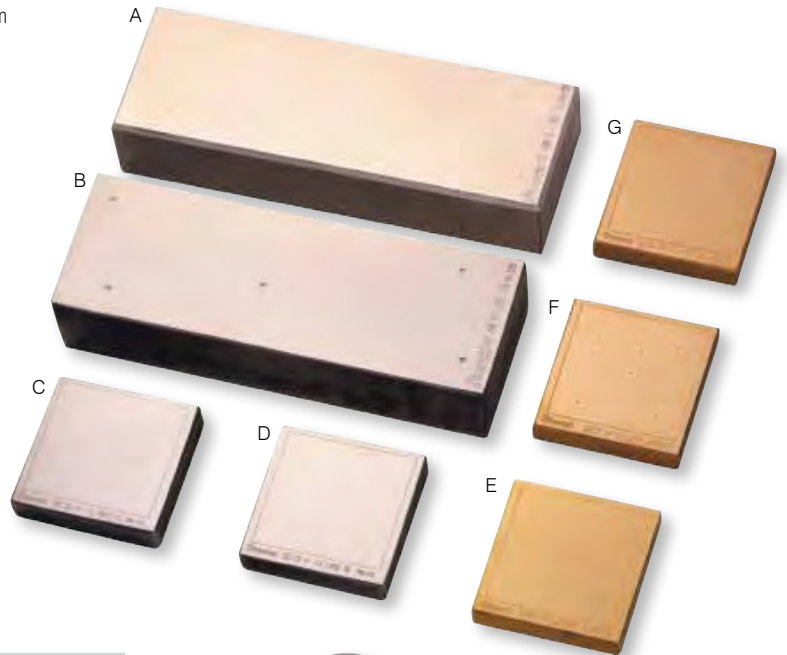

Rockwell Test Blocks	
Cat No	Description *
PT05050	RC63 Test Block
PT05051	RC60 Test Block
PT05052	RC55 Test Block
PT05053	RC50 Test Block
PT05054	RC45 Test Block
PT05055	RC40 Test Block
PT05056	RC35 Test Block
PT05057	RC30 Test Block
PT05058	RC25 Test Block
PT05059	RB90 Test Block
PT05060	RB80 Test Block
PT05061	RB70 Test Block
PT05062	RB60 Test Block
PT05063	RB50 Test Block
PT05064	RB40 Test Block
PT05065	RB30 Test Block
PT05067	RB20 Test Block
PT05068	RB10 Test Block
PT05069	RA80 Test Block
PT05091	RA70 Test Block
PT05092	RA60 Test Block
PT05100	RF100 Test Block
PT05101	RF90 Test Block
PT05102	RF80 Test Block
PT05103	RF70 Test Block
PT05104	RF60 Test Block
PT05105	RF50 Test Block
PT05106	RE100 Test Block
PT05107	RE90 Test Block
PT05108	RE80 Test Block
PT05112	RE70 Test Block
PT05113	RE60 Test Block
PT05114	RE50 Test Block
PT05115	HR30N80 Test Block
PT05122	HR30N70 Test Block
PT05123	HR30N60 Test Block
PT05124	HR30N50 Test Block
PT05125	HR30N40 Test Block
PT05127	HR30T80 Test Block
PT05128	HR30T70 Test Block
PT05129	HR30T60 Test Block

Rockwell Test Blocks	
Cat No	Description *
PT05130	HR30T50 Test Block
PT05177	HR30T40 Test Block
PT05178	HR30T30 Test Block
PT05179	HR30T20 Test Block
PT05180	HR30T10 Test Block
PT05181	HR15N90 Test Block
PT05182	HR15N80 Test Block
PT05183	HR15N70 Test Block
PT05184	HR15T90 Test Block
PT05185	HR15T80 Test Block
PT05186	HR15T70 Test Block
PT05187	HR15T60 Test Block
PT05188	HR45T70 Test Block
PT05189	HR45T60 Test Block
PT05191	HR45T50 Test Block
PT05192	HR45T40 Test Block
PT05193	HR45T20 Test Block
PT05194	HR45T10 Test Block
PT05195	HRH90 Test Block
PT05196	HRH80 Test Block
PT05197	HRR120 Test Block
PT05198	HR30Y Test Block
PT05199	HRM Test Block
PT05200	HR15W Test Block

Brinell Test Blocks	
Cat No	Description
PT05257	3000kg High Brinell Test Block
PT05258	3000kg Low Brinell Test Block
PT05259	500kg High Brinell Test Block
PT05260	500kg Low Brinell Test Block



Penetrators: (A) 1/2" Ball Unit, (B) 1/4" Ball Unit, (C) 1/8" Ball Unit, (D) 1/16" Ball Unit and (E) Diamond Cone or "C" Regular. (F) Vickers/Knoop and (G) Newage-type indenter styles are also shown – contact Starrett for further information.

Penetrators	
Cat No	Description
PT05245	"C" Regular
PT05246	Indetron
PT05247	Versitron
PT05248	"N" Regular
PT05249	1/16" (1.6mm) Ball Unit
PT05250	1/8" (1.7mm) Ball Unit
PT05251	1/4" (6.4mm) Ball Unit
PT05252	1/2" (12.7mm) Ball Unit
PT05253	1/16" (1.6mm) Carbide Ball Unit, with Certification
PT05254	1/8" (1.7mm) Carbide Ball Unit, with Certification
PT05255	1/4" (6.4mm) Carbide Ball Unit, with Certification
PT05256	1/2" (12.7mm) Carbide Ball Unit, with Certification
PT05261	Heavy Load, Vickers 5kg Load
PT05264	Heavy Load Indentor
PT05265	Min. Brinell 2 1/2mm Ball
PT05266	Min. Brinell Block 187 1/2kg, 2-1/2mm Ball



Standard and special anvils.

Anvils & Table	
Cat No	Description
PT05267	Pedestal Anvil
PT05268	2-1/2" Flat Anvil
PT05269	Small "V" Anvil
PT05270	Large "V" Anvil
PT05271	8" Anvil Testing Table

* Values expressed are not exact but, will range within acceptable limits.

SR100 - SURFACE ROUGHNESS TESTER

The SR100 portable surface roughness tester is powerful, accurate and easy to use. The SR100 can measure roughness almost anywhere. It is ideal for checking large components, structures, auditing batch production prior to shipment and production line process control. The innovative SR100 separates into two pieces to measure surface roughness. The bottom half of the SR100 contains the traverse mechanism and stylus pickup assembly which is placed on the surface to be measured. Its wide base ensures stability. The upper half includes a large LCD display, start button, mode and parameter buttons, comfortably hand-held for easy operation and clear viewing. A diamond stylus is drawn across the part, the motorised traverse mechanism is cam driven to ensure that the correct horizontal distance is traveled. Vertical movement of the stylus as it travels across peaks and valleys is detected by a piezoelectric pickup which converts the mechanical movement of the stylus into an electrical signal. The electrical signal is digitized and sent to a microprocessor where the parameters are calculated using standardised algorithms.

Technical Specifications	
Gauge Range	200 μ m / 0.008 μ in
Accuracy	5% of Reading + 0.1 μ m / 4 μ in
Pick Up Type	Piezoelectric
Gauge Force	200mg
Stylus	Diamond, Radius 5 μ m / 200 μ in
Cut Off Value	0.8mm / 0.03" \pm 15%
Filter	2CR
Traverse Length	5mm / 0.2"
Traverse Speed	2mm/Sec, 0.8"/Sec
Display Units	μ m / μ in
Battery Life	5,000 Operations Minimum
Dimensions	125 x 80 x 38mm / 4.92 x 3.15 x 1.5"
Weight	200gms

Component Dimensions & Condition	
Min Bore	65mm / 2.6"
Min Diameter	25mm / 1"
Max Temperature	35°C / 95°F

Nominal Operating Conditions	
Temperature	20°C / 68°F
Humidity	0 - 80% Non Condensing

Storage Conditions	
Temperature	0 - 50°C / 32 - 122°F
Humidity	0 - 80% Non Condensing

Parameter Results		
Parameters	Range	Resolution
Ra, Rz, Rv, Rp, Rt		
Ra	40 μ m / 1600 μ in	0.01 μ m / 0.4 μ in
Rz, Rv, Rp, Rt	199 μ m / 7800 μ in	0.1 μ m / 4 μ in



The SR100 uses an infra-red (IrDA) link between the upper and lower units to provide remote, cable free operation up to a distance of one metre (40").



Cat No	Description
SR100	Two Piece Surface Roughness Tester

SR200 - SURFACE ROUGHNESS TESTER

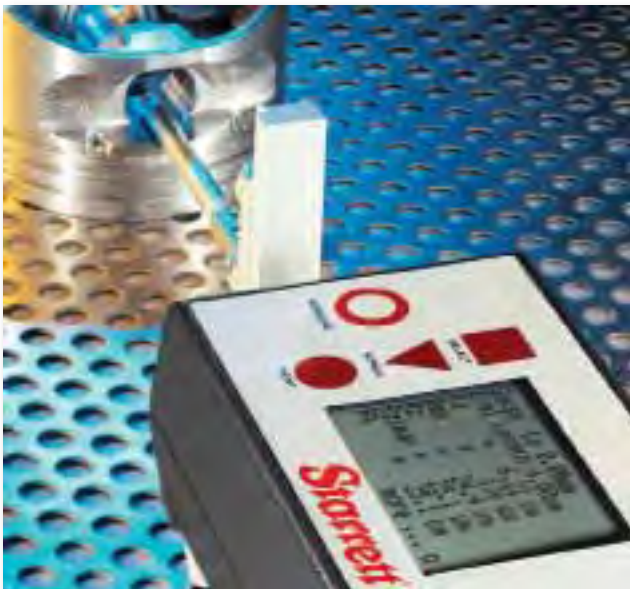
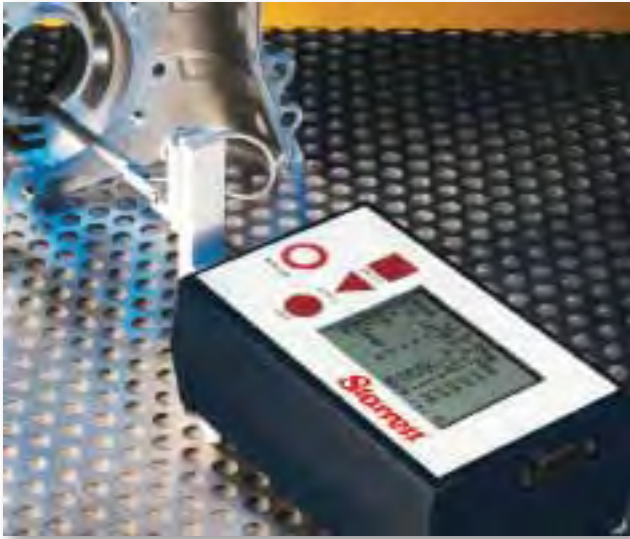

The Starrett SR200 is a full featured, powerful and versatile surface roughness tester. It can be used either freestanding (on horizontal, vertical or even inverted surfaces) or bench mounted with fixturing for batch measurement and laboratory applications. It is battery powered for portability, with an AC adapter available.

The SR200 is truly portable with no PC or printer cables in the way of measurements - take it to wherever you need to take measurements, save up to 100 batch readings and then download to your PC or printer at your convenience.

MEASUREMENT PARAMETERS

Amplitude Parameters - Measures Vertical Characteristics Of Surface Deviations

Parameters	Description
Ra	Arithmetic Mean Deviation
Rsk	Skewness
Rz	Average Peak To Valley Height
Rt	Total Height Of Profile
Rp	Max Profile Peak Height
Rz1max	Max Peak To Valley Height

Spacing Parameters - Measures Horizontal Characteristics Of Surface Deviations

Parameters	Description
RPc	Peak Count
RSm	Mean Width Of Profile Elements

Hybrid Parameters - Combinations Of Spacing & Amplitude Parameters

Parameters	Description
Rmr	Material Ratio
Rda	R _A Arithmetic Mean Slope

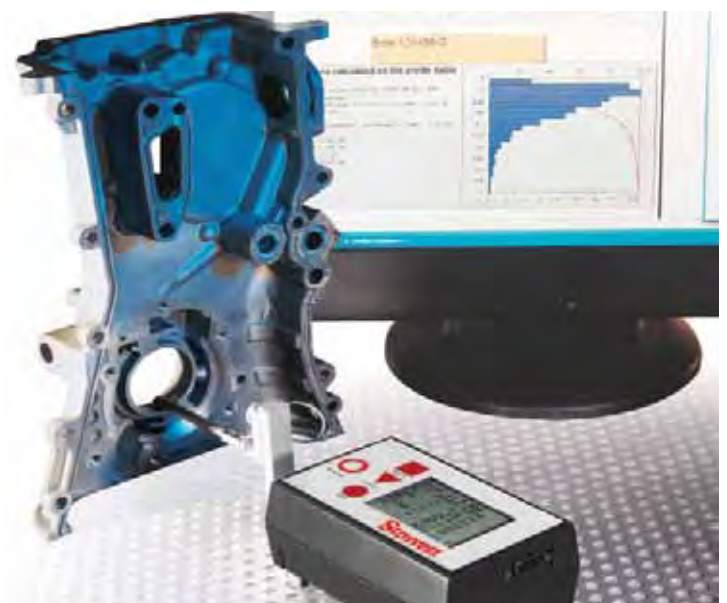

SR200 - SURFACE ROUGHNESS TESTER

TalyProfile Lite Software Included with the SR200

The SR200 includes TalyProfile Lite, Windows software with powerful analysis features.

After receiving data from the SR200, TalyProfile Lite can immediately analyze, print, export as a .txt or .csv file, or save it as a document that can be reopened and used as a template for future measurements.

Outstanding Graphics

TalyProfile Lite provides clear on screen profile images. Users can take basic measurements and create a full report using the software's detailed analysis options and publishing capabilities.

In-Depth Analysis

Profiles can be levelled and zoomed to remove unwanted features or defects from the analysis. Distance measurement between features and areas of a profile, step height, area of a hole and peak can all be easily displayed, graphically and numerically.

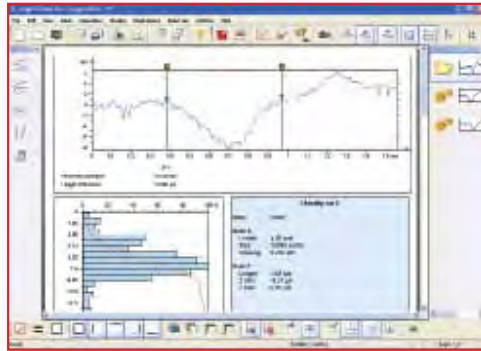

Time-saving Templates

A sequence of analysis functions can be saved as a "template" and applied to future measurements, turning detailed reporting tasks into routine documents.

Presentation

TalyProfile Lite includes professional presentation capabilities. Graphs, profiles and results can be arranged and printed within TalyProfile and also has the flexibility to export to other presentation software.



Easy Upgrade Path

TalyProfile Lite provides an easy upgrade path to the more advanced Silver and Gold versions. TalyProfile Silver has all functions typically used for shopfloor inspection. TalyProfile Gold includes complete laboratory analysis functions.

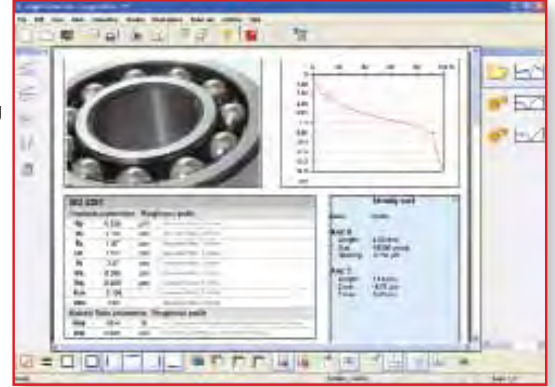

TalyProfile Features	Lite	Silver	Gold
Acquisition interface	x	x	x
Multiple file format reports	x	x	x
Graphical display	x	x	x
Desktop publishing templates	x	x	x
Document page viewer	x	x	x
Levelling	x	x	x
Symmetries	x	x	x
Zoom	x	x	x
Distance measurement	x	x	x
Profile curves	x	x	x
Area of a hole / peak	x	x	x
Abbott-Firestone Curve	x	x	x
Mini Documents		x	x
Save Profile (export data)		x	x
Basic & 2D file formats		x	x
Tolerance limits		x	x
Join Two Profiles			x
Resampling			x
Form removal			x
Retouch profile points			x
Filtering by FFT			x
Fractal analysis			x
R & W Motifs (ISO 12085)			x
Rk Calculation of Profiles			x
Graphical RK Parameters			x
Step height measurement			x
Frequency spectrum			x
Morphological Envelopes			x
Thresholding			x
Power spectrum density			x

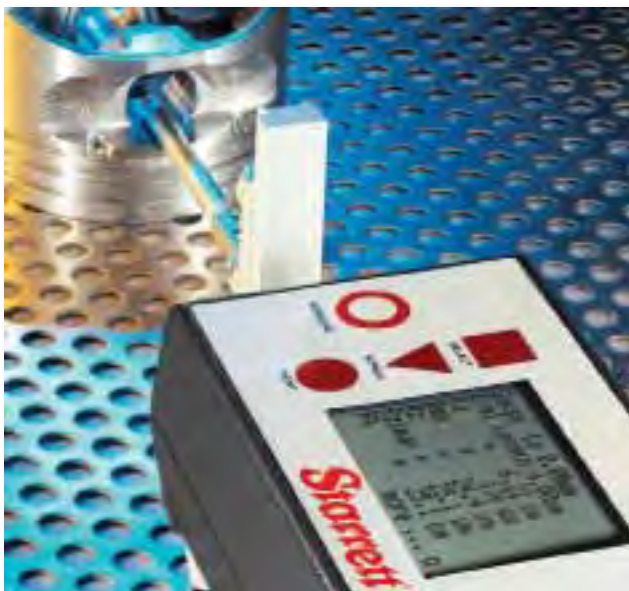

SR200 - SURFACE ROUGHNESS TESTER

Pickups

An extensive range of pick-ups are available to meet a variety of measurement requirements.

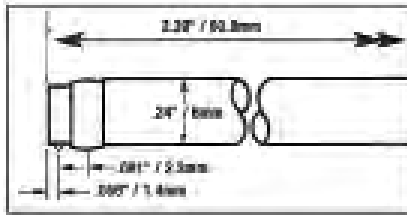

Standard Pickup
For general surface roughness measurement.
Cat No. SR-112-1502

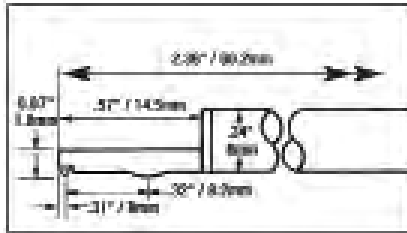

Small Bore Pickup
For general use in small bores, grooves and on narrow surfaces.
Cat No. SR-112-1504

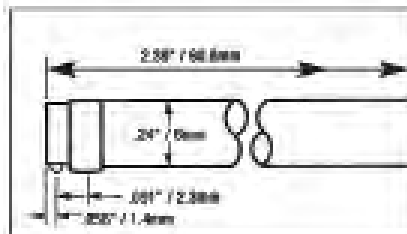

Right Angle Pickup
For measurement at right angles to the direction of traverse.
Cat No. SR-112-1505

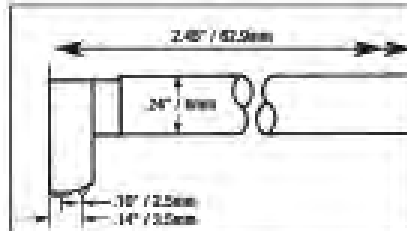

Recess Pickup
For recess to a depth of 5.7mm / 0.23\"/>

Technical Specifications

Pickup

Gauge Range	300 μ m / 0.012 μ in
Resolution	0.01 μ m / 0.04 μ in
Accuracy	2% of Reading + LSD μ m
Pick Up Type	Inductive
Gauge Force	150 - 300mg / 0.005 - 0.01oz
Diamond Stylus	Tip Radius 5 μ m / 200 μ in, unless otherwise specified

Instrument

Cut Off Value	0.25, 0.8, 2.5, 8mm / 0.01, 0.03, 0.3"
Filter	2CR or Gaussian (Selectable)
Traverse Length	0.25 - 25mm / 0.01 - 0.98"
Traverse Speed	1mm/Sec / 0.04"/Sec
Display Units	μ m / μ in
Data Output	RS232
Power	9V Battery or Optional Power Supply

Dimensions

Overall	127 x 85 x 60mm / 5 x 3.35 x 2.4"
Weight	450gms / 1lb
Max Temperature	35°C / 95°F

Nominal Operating Conditions

Temperature	5 - 40°C / 41 - 104°F
Humidity	0 - 80% Non Condensing

Storage Conditions

Temperature	0 - 50°C / 32 - 122°F
Humidity	0 - 80% Non Condensing

Storage Capacity

Capacity	100 Measurement Results
----------	-------------------------

Parameters

Ra, Rz, Rt, Rp, Rmr, Rpc, Rsm, Rz1max, Rsk, Rda

Cat No	Description
SR200	Surface Roughness Tester
SR-112-1510	200mm / 7.875" Extension Rod With Lead
SR-112-1534	Reference Standard
SR-112-1517	Support Stand
SR-112-2693	Column & Stand
SR-112-1502	Standard Pickup With 5 μ m / 200 μ " Stylus
SR-112-1503	Standard Pickup With 10 μ m / 400 μ " Stylus
SR-112-1504	Small Bore Pickup
SR-112-1505	Right Angle Pickup
SR-112-1506	Recess Pickup
SR-112-3680	TalyProfile Gold - 2D Analysis Software c/w Cable
SR-112-3681	TalyProfile Silver - 2D Analysis Software c/w Cable
SR-K509-1578	TalyProfile 2.5M / 8' Cable
SR-K509-1820	TalyProfile 1.5M / 5' Cable
SR-112-3530	Power Adapter UK
SR-112-3531	Power Adapter 110V US
SR-112-3532	Power Adapter 230V EURO



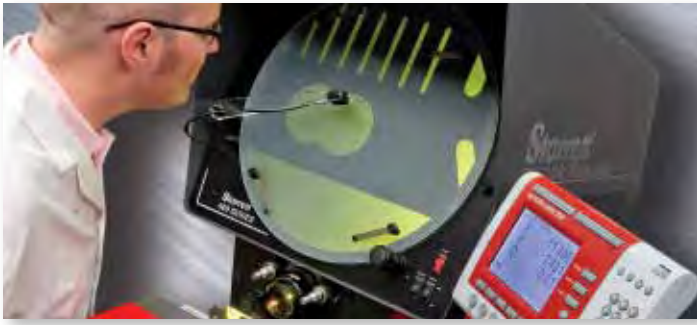

CAT NO	DESCRIPTION	PAGE	CAT NO	DESCRIPTION	PAGE
1	M1 All Purpose Lubricant	25	660	Magnetic Base Indicator Holder	19
2	Angle Meter	25	661	Mini Magnetic Base Indicator Holder	19
6	Screw Pitch Gauge	21	666	Feeler Stock Roll In Dispenser	23
9	Combination Sets	20	667	Thickness Gauge "Feeler Stock"	22
18	Automatic Centre Punches	24	682	Saw Tension Gauge	26
25	Dial Indicators	18	696	Crankshaft Distortion Dial / Strain Gauge	26
60	Precision Steel Squares	20	698	Video Borescope	28
63	Long Range Micrometer Heads	13	699	Video Borescope	28
66	Thickness Gauges	21	700	Inside Micrometer	13
78	3 Point Internal Bore Gauge Micrometer Sets	15	749	Electronic Digital Depth Micrometer	13
81	Rectangular Steel Gauge Block Sets	27	762	Electronic Digital Micrometer Heads	13
82	Dial Bore Gauges	16	781	ACCUBORE® Electronic Bore Gauges & Sets	14
88	Rectangular Steel Gauge Block Sets	27	795	IP67 Electronic Digital Micrometer	10
98	Machinists' Levels	23	796	IP67 Electronic Digital Micrometer	10
100	Surface Roughness Tester	34	798	IP67 Electronic Digital Calipers	6
112	Rectangular Steel Gauge Block Sets	27	799	Electronic Digital Calipers	6-7
117	Centre Punches	24	823	Tubular Inside Micrometers	14
124	Solid-Rod Inside Micrometers	14	827	Edge Finders	23
125	Vernier Calipers	6	829	Small Hole Gauges	16
130	Bench Level	23	831	Small Hole Gauges	16
154	Adjustable Parallels	21	1201	Dial Calipers	6
155	Screw Pitch Gauge	21	1202	Dial Calipers	6
156	Screw Pitch Gauge	21	1251	Long Range Vernier Calipers	7
159	Screw Pitch Gauge	21	1610	KLEENSCRIBE® Layout Dye	25
167	Radius Gauge Set	22	1620	Tool & Instrument Oil	25
173	Thickness Gauges	21	2000	ALTISSIMO® Electronic Height Gauges	8-9
196	Universal Back Plunger Dial Indicators	17	2900	IP67 Electronic Digital Indicators	18
200	Surface Roughness Tester	35-37	3015	Thickness Gauges	17
207	Stainless Steel Can Seam Micrometers	12	3020	Precision Steel Squares With Base	20
208	Stainless Steel Can Seam Micrometers	12	3025	Dial Indicators	18
224	Outside Micrometers With Interchangeable Anvils	11	3047	Rectangular Steel Gauge Block Sets	27
248	Long Range Drive Pin Punches	24	3081	Dial Indicator	18
256	Disc Type Micrometers	12	3088	Rectangular Steel Gauge Block Sets	27
263	Micrometer Heads	13	3089	Bore Gauge Sets	15
269	Taper Gauges	22	3097	Precision Level	23
270	Taper Gauge	21	3206	Micrometer Stand	19
272	Radius Gauges	22	3600	Electronic Digital Indicators	18
435	Combination Sets	20	3648	Base Extension With Screws For 3753 Series	7
436	Standard Outside Micrometers	11	3657	Magnetic Base Indicator Holders	19
436	Standard Outside Micrometer Sets	11	3732	Electronic Digital Micrometer	10
440	Depth Micrometers	13	3751	Electronic Digital Height Gauge	7
444	Standard Outside Micrometers With Thermal Insulated Cover	11	3752	Electronic Digital Height Gauge	7
445	Depth Micrometers	13	3753	Electronic Digital Depth Gauges	7
460	Standard Micrometer Heads	13	3805	Electronic Durometer	30
463	Standard Micrometer Heads	13	3808	Dial Test Indicator	18
467	Thickness Gauge	21	3809	Dial Test Indicator	18
472	Screw Pitch Gauge	21	3810	Digital Portable Hardness Tester	30
474	Screw Pitch Gauge	21	3811	Portable Hardness Tester	30
476	Screw Pitch Gauge	21	3812	Ultrasonic Thickness Gauge	29
486	Blade Type Micrometers	12	3813	Coating Thickness Gauge	29
565	Drive Pin Punches	24	3814	Analogue Bench Hardness Tester	31
579	Telescoping Gauges	14	3815	Twin Analogue Bench Hardness Tester	31
635	Steel Rules	20	3816	Digital Bench Hardness Tester	32
636	Steel Rules	20	7793	Pocket Laser Tachometer Kit	26
653	Dial Gauge Stands	19			



Starrett®

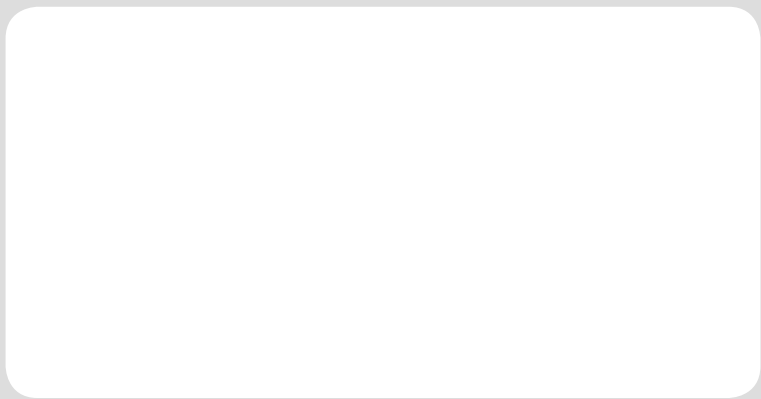

Starrett (Asia) Pte Ltd.
35, Marsiling Industrial Estate Road 3,
#05-04
Singapore 739257

Tel: 00 65 6365 1088
Fax: 00 65 6365 5125

Email: starrett_asia@starrett.com.sg
Web: www.starrett.com.sg