

Licence by DLR

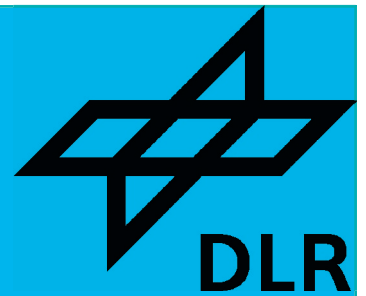

ASURO ROBOT KIT

© DLR Germany and AREXX - The Netherlands

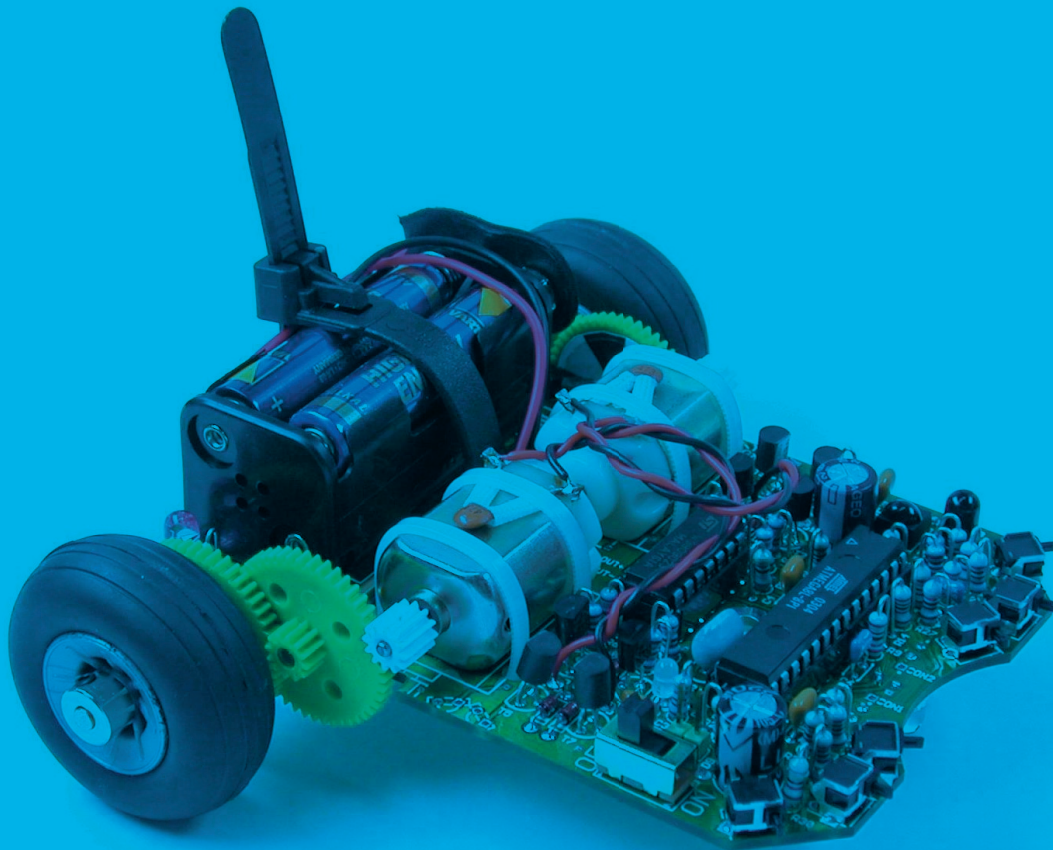

Assembly and Operation MANUAL

Model ARX-03

Manufacturer

AREXX, Zwolle - NETHERLANDS
JAMA, Taichung - TAIWAN

www.arexx.com



Introduction

ASURO is a mobile mini-robot, completely programmable in C and especially developed for education at the German Aerospace Centre DLR, department for Robotics and Mechatronics. Assembly is easy for experienced electronic technicians and feasible for a novice. Except for the printed circuit boards (PCB) only standard parts for assembly will be used.

For programming we use freeware only. Therefore ASURO is exceptionally suitable as an introduction into processor-controlled hobby electronics, for projects in schools and universities, for studies and adult education centres. Special tools, which are freeware for private users, have been used for all electronic development phases and software design, proving how robots can be designed without using expensive tools or machines.

ASURO is equipped with a RISC-processor and two independently controlled motors, an optical line-tracer, six collision-detector switches, two odometer-sensors, three optical displays and an infrared-communication set for programming and remote control by a PC (see fig. 0.1).



The Caution-symbol  signalizes paragraphs with warnings, to be studied intensively, to prevent damage to components or personal health.

We must inform all users, ASURO is no toy and is not to be handed out to children under the age of three years, as they may swallow the dozens of small components. Please provide some batteries and start the assembly!

And yes: ASURO is another way of saying: "Another Small and Unique Robot from Oberpfaffenhofen!"

© DLR & AREXX

Oberpfaffenhoven 2004

Jan Grewe
Robin Gruber

WWW.DLR.DE
WW.AREXX.COM

Fig. 0.1 ASURO blockdiagram
(see also appendix E)

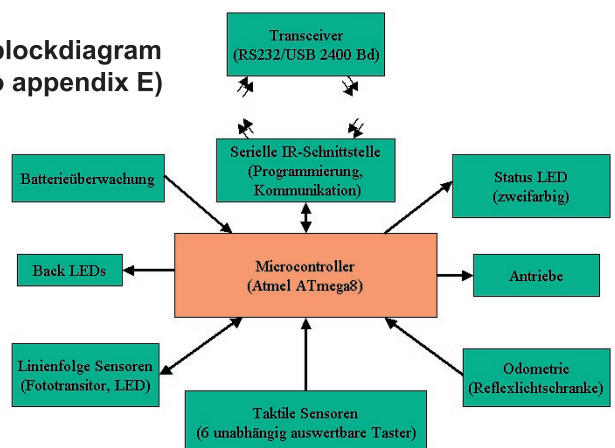

WARNING

- * When you open the parts the return right will be disposed
- * Read before you start assembly the instruction manual
- * Be careful with tools
- * Keep this product out of reach of children and do not build this kit when children are in the neighbourhood, the tools and parts are dangerous for children
- * Check the polarity of the batteries
- * Keep the batteries dry, when the ASURO gets wet remove the batteries and let the ASURO dry for some time
- * Remove the batteries when you are not using the ASURO for a longer period

CONTENTS

I. Mechanics	6
1. Necessary tools	6
2. Mechanical preparations	7
2.1. Motorpinion	7
2.2. Table-tennis ball	7
2.3. Axles	8
2.4. Wheel sensors	8
II. Electronics	9
3. Soldering instructions	9
3.1. Tip, solder and temperature	9
3.2. Preparing parts	10
3.3. Soldering parts	11
3.4. De-soldering	12
4. Electronic assembly	13
4.1. Assembly RS232-Infrared-Transceiver	13
4.2. Optional USB-Infrared-Transceivers	15
4.3. Assembly ASURO-PCB	16
4.4. Attachment of the motors	20
4.5. Power supply	20
5. Preparation for operation	21
5.1. RS232-Infrared-Transceiver	21
5.2. USB-Infrared-Transceiver	22
5.2.2. Linux	23
5.3. ASURO operation	24
5.3.1. Display-elements	25
5.3.2. Phototransistors (T9, T10)	25
5.3.3. Switches	26
5.3.4. Odometrie	26
5.3.5. The engine	26
5.3.6. IR interface	26
5.3.7. READY?	27

6. Trouble shooting	28
6.1. Failure of RS232-IR-Transceiver !	28
6.1.1. Activated key and displayed symbol do not match	28
6.1.2. The Terminal-Programm does not display any symbol	28
6.1.3. Still not working	28
6.2. USB-Infrared-Tranceiver does not work	28
6.3. Back-LEDs (D15,D16) glimmen nach dem Einschalten nicht!	28
6.3.1. Back-LEDs do not glow at start up	29
6.3.2. Only one of the back LEDs is glowing	29
6.3.3. Status-LED (D12) is not activated biocolored after start up	29
6.4. A display does not work	29
6.4.1. Status-LED D12 does not work	29
6.4.2. Front-LED D11 does not work	29
6.4.3. Left Back-LED D15 does not work	30
6.4.4. Righth Back-LED D16 does not work	30
6.5. Linetracer (T9, T10) does not work	30
6.6. A switch does not work	30
6.6.1. Obviously a combination of switches has been activated	31
6.6.2. Display reacts if switches have been interchanged	31
6.6.3. Things still do not work well	31
6.7. The reflected light-sensor (odometer) does not work	31
6.7.1. None of the reflected light-sensors work	31
6.7.2. The left reflected light-sensors does not work	31
6.7.3. The right reflected light-sensors does not work	31
6.8. One motor does not move	32
6.8.1. Both motors do not move	32
6.8.2. Left motor does not move or only in one direction	32
6.8.3. Right motordoes not move or only in one direction	32
6.8.4. One motor rotates in reversed direction	32
6.9. IR-interface	32
6.9.1. ASURO does not send symbols	32
6.9.2. ASURO does not receive symbols	32
6.9.3. Things still do not work well	33

7. Final adjustments	34
-----------------------------	-----------

III. Software	35
8. Software installation and initial steps	35
8.1. WINDOWS	35
8.1.1 Installation Flash - the ASURO-Programmer-Tool	35
8.1.2 Installation of the editor and compiler	35
8.1.3. Example programs	39
8.2. LINUX	51
8.2.1. Installation Flash - the ASURO-Programmer-Tool	51
8.2.2. Compiler	52
8.3. Working with Flash	53
8.4. Flash failures	54
8.5. First step in Programming	54
9. C for ASURO	56
9.1. Basics in C-Programmierung	56
9.1.1. Introduction	56
9.1.2. Variables and datatypes	57
9.1.3. Compilerdirektives	59
9.1.4. Conditions	59
9.1.5. Loops	61
9.1.6. Functions	62
9.1.7. pointers and vectors	64
9.2. Overview of the ASURO functions	65
9.2.1. void Init(void)	66
9.2.2. void StatusLED (unsigned char color)	66
9.2.3. void FrontLED (unsigned char status)	67
9.2.4. void BackLED (unsigned char left, unsigned char right)	67
9.2.5. void Sleep (unsigned char time72kHz)	67
9.2.6. void MotorDir (unsigned char left_dir, unsigned char right_dir)	67
9.2.7. void MotorSpeed (unsigned char left_speed, unsigned char right_speed)	68
9.2.8. void SerWrite (unsigned char *data, unsigned char length)	68
9.2.9. void SerRead (unsigned char *data, unsigned char length, unsigned int timeout)	68
9.2.10. void LineData (unsigned int *data)	69
9.2.11. void OdometrieData (unsigned int *data)	70
9.2.12. unsigned char PollSwitch (void)	71
IV. Appendices	72
A. Partlist	72
B. Diagram ASURO	74
C. RS-232 IR Transceiver	75
D. USB IR-Transceiver	76
E. Blockdiagram ASURO	77
F. Blockdiagram PIC Processor	77
G. Contents ASURO KIT	78

Part I. Mechanics

1. Necessary tools

In order to build the ASURO we need – apart from the kit – the following tools:

- A „third hand“
- Stanley-Knife
- Small hammer
- Sandpaper (for fine work, Nr. 240)
- Long nose plier for electronic work
- Cutter for electronic cable work
- Soldering iron for electronic work (approx. 20-30 W) or a soldering station
- Solderwire (1 mm) for electronic work, optionally leadfree
- Desoldering wick (2-3 mm width), just in case solder has to be removed from the print
- Glue (either an instant 1-component glue, a bicomponent glue or a hot glue pistol)
- Computer: a laptop or personal computer (operated with Windows or Linux)
- Optionally: a multimeter

* For the optional USB IR-Transceiver you may need an USB cable A to B

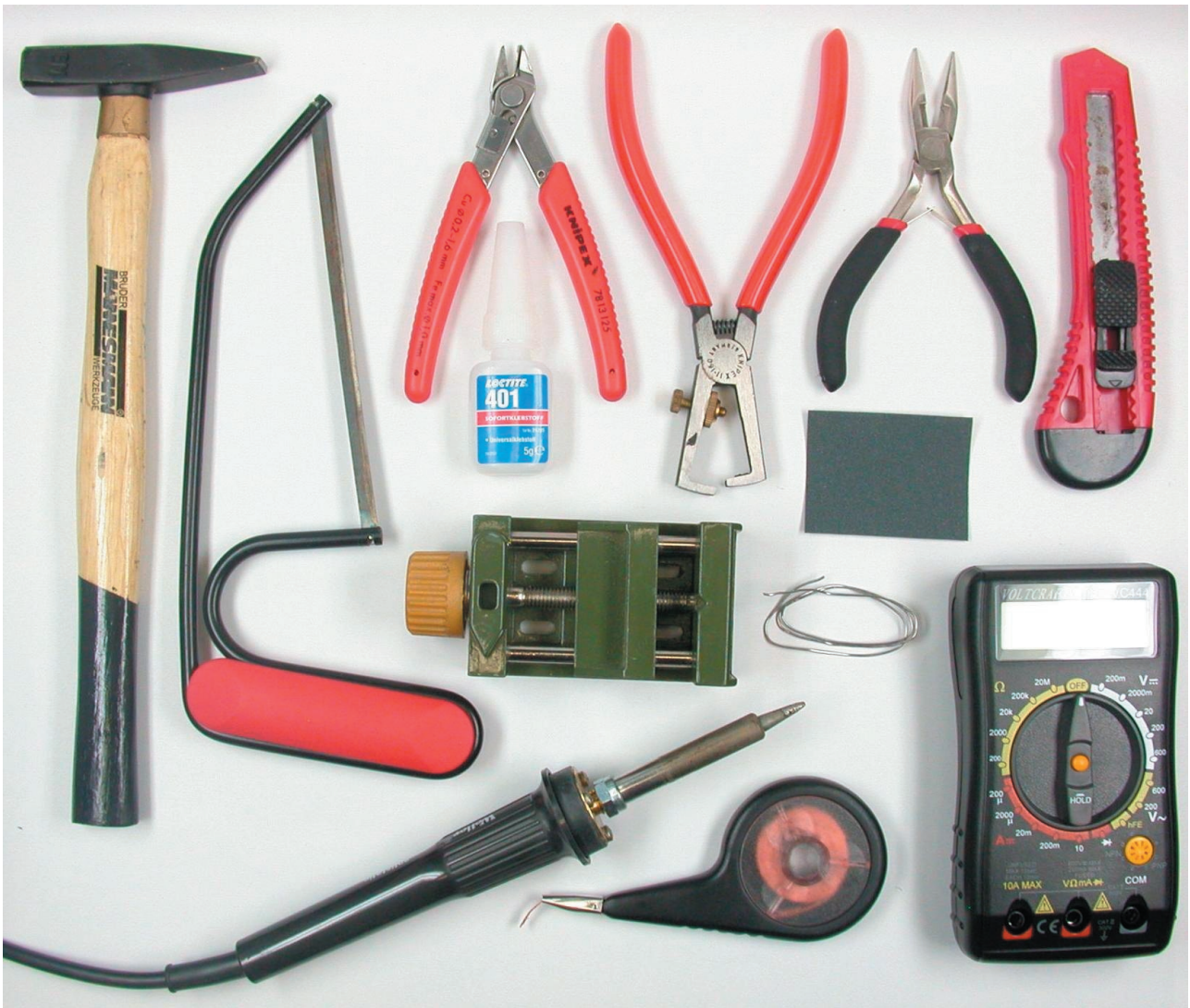

Figure 1.1: Necessary tools

2. Mechanical Preparations

Completeness of the kit must be checked first. A parts list in appendix A has been provided as a checklist. Before doing any electronic artwork, we must however do some mechanical preparations. So let's start working.

2.1. Motorpinion

Motor power is to be transmitted to the gear by small cogwheels (with drilling holes of 1.9 mm), which have to be pressed onto the motor axles. Place the rounded side of the cogwheel on a flat surface and press the motor axle gently into the drilling hole of the cogwheel without using too much force. You may use a small hammer to press the axle of the motor fully into the cogwheel, by placing the cogwheel on a weaker surface (eg. cardboard) and applying the hammer gently to the backside axle of the motor (see fig. 2.1).

Alternatively you may press the cogwheel to the motor axle by using the benchvice. Take care to press the axle and not to apply any force to the case or the bearings.

Fig. 2.1.: Motorpinion assembly

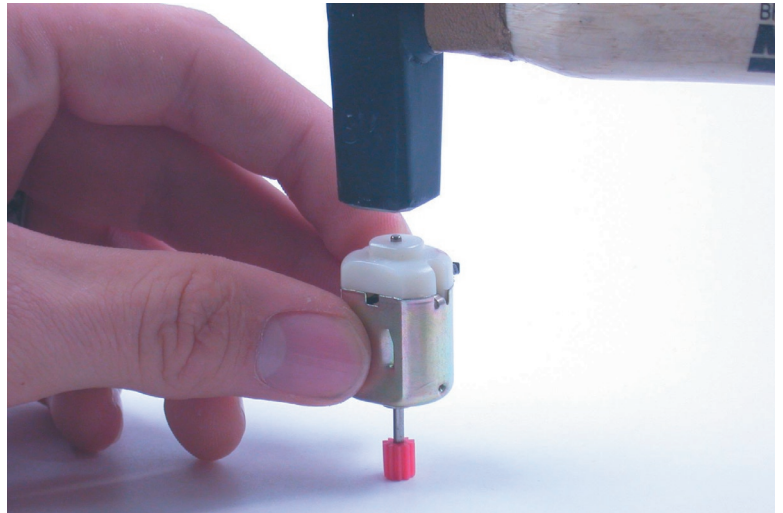

2.2. Table-tennis ball

ASURO has been designed to slide on the halve of a table-tennis ball, which has to be prepared. The best way to do this is to take a complete ball and to cut it in two halves with a saw or a Stanleyknife. The cutting edges can be cleaned up with a file or sandpaper.

That's all!

Fig. 2.2. Table-tennis ball



Do not use electrical aids like an electrical saw or electrical knife. Table-tennis balls may be set afire very easily.

2.3. Axles

Axles are manufactured from a brass rod. Two pairs of axles are needed, each with a length of 24.5 mm and 42.0 mm respectively. These axes are supplied in correct length with this kit.

2.4. Wheel sensors

The odometer, consisting of a light emitting diode and a phototransistor, looks forward to the black and white markers on the 50/10 cogwheel.

A complete set of adhesive odometer markers is supplied with this kit. Place them on to the 50/10 gear as shown in fig. 2.3. **Using the sensor-markers with 6 black and white segments is recommended for compatibility for compatibility with other ASURO's (demo programs).**



fig. 2.3.:
RECOMMENDED
cogwheel markers

The more segments you draw, the better the cogspeed may be registered and the better speed control will work. However, a great number of segments reduces the difference between light and dark (see fig.2.4).

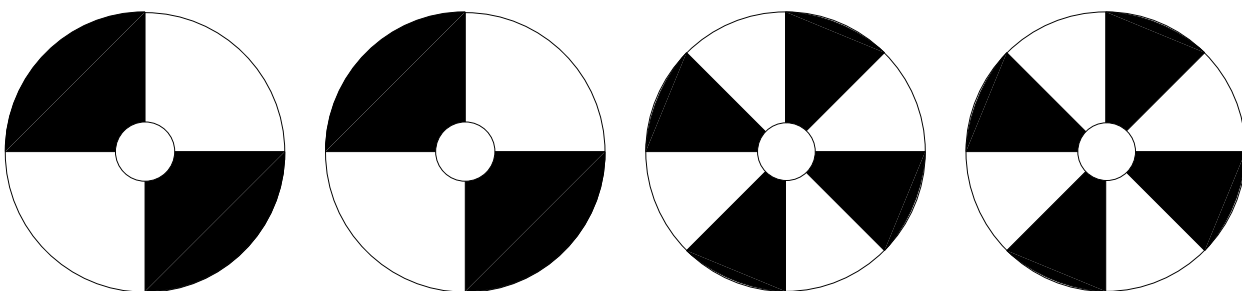

fig. 2.4.: Examples for the cogwheel markers

You now have completed the mechanical preparations.

Take a short break ...

We will now continue with the electronics.

Part II. Electronics

3. Soldering instructions

ASURO has been designed with wired parts (in contrast to the much smaller surface mounted devices). Fig. 3.1 demonstrates the smallest available package for the ASURO processor IC and the wired device we have incorporated. The chip inside these devices however is the same! Although soldering wired devices is much more comfortable and easier, especially untrained persons have to consider some precautions.



*Of course the printed circuit board must be unplugged at any time while soldering. Switching off is not enough !! **REMOVE batteries and power supplies!!!***

3.1. Tip, solder and temperature

Fig. 3.2 demonstrates the basics for soldering. The hot spot of the soldering equipment should reach ca. 360°C with lead-solder and ca. 390°C for lead-free solder, while soldering axles may be done at higher temperatures (420°C). Electronics are to be soldered with a miniature tip, while axles must be soldered with a larger tip area.

Use a slightly humid soldering sponge and apply some solder to the hot soldering tip. Shortly before using soldering equipment, for the first time or after a break, old solder must be removed by wiping off soldering remains from the tip.

Do use solder for electronic work with a diameter of 0.8 or 1 mm.

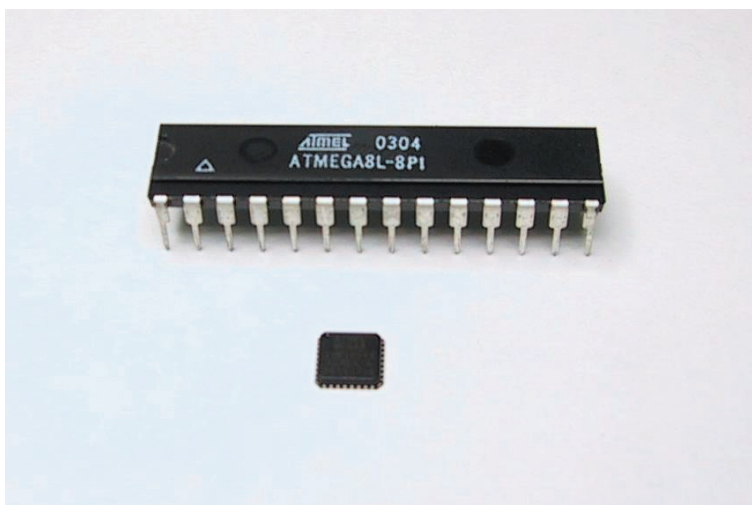

Fig. 3.1.: Comparison of the largest and smallest case in which the ATmega8L chip is available.

DANGEROUS END !



Fig. 3.2.: Basics for soldering



While soldering, some smoke will be generated which may cause damage to your health. Avoid breathing gases or work under a cooker hood. Using solder for non-electronic use and using resins may destroy components.

3.2. Preparing parts

While soldering small parts you will need some tricks and tips to reach the soldering area. When you already have soldered before you already may have noticed that there is always one hand short (a tool called third hand can solve a part of this problem).

Some parts (transistors, LEDs, ICs, switches, capacitors and jumper) are already prepared to fit into the PCB (printed circuit board), but diodes and resistors have to be prepared to do so.

Resistors are to be placed vertically in ASURO. To do so, one leg remains in its original position, the other one is to be bent 180 degrees. Bending must be done at a curvature of 2.5 mm diameter at a distance of a few millimeters from the resistor body to avoid damage to the part.

Diodes are inserted for horizontal position. To do so both legs have to be bent (eg. by pincers) at a distance to fit into the holes of the PCB.



Processor IC1 ATmega, IC3 CD4081 and the IR-receiver IC2 SFH5110-36 are sensitive to ESD (electrostatic damage). They may be damaged by simply touching or even reaching for these parts if you have been charged with electricity (eg. by walking on a carpet). Before handling these parts you should discharge yourself with a discharging bracelet, connected to ground or at least by touching a grounded heater system or a metallic case of equipment.

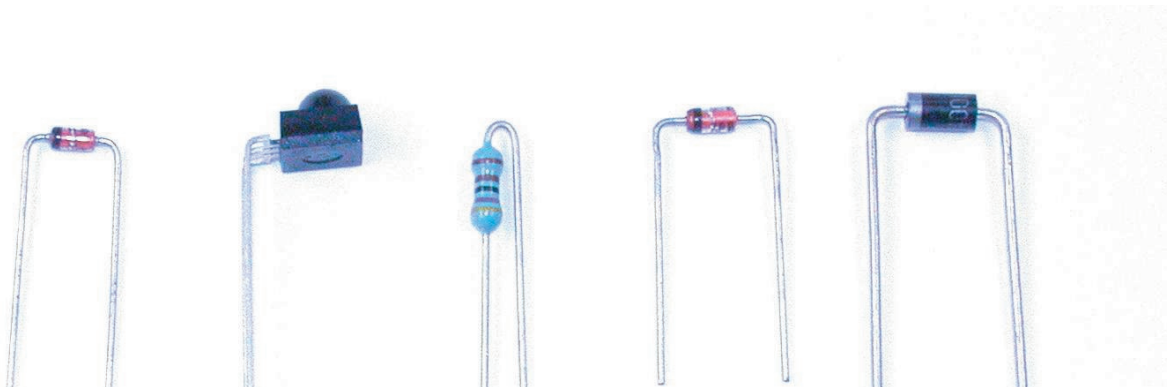

Fig. 3.3 : Parts with bended legs

A. Part

B. Leg, solder pad, and bending area have to be heated simultaneously

C. Solder must flow into the drilling hole

D. Solder

E. Round bending area without edges

F. Soldering tip

G. Neat, vulcano-shaped soldering cone

H. Bending legs to prevent parts falling out from the PCB

I. Bend area at some distance from the part

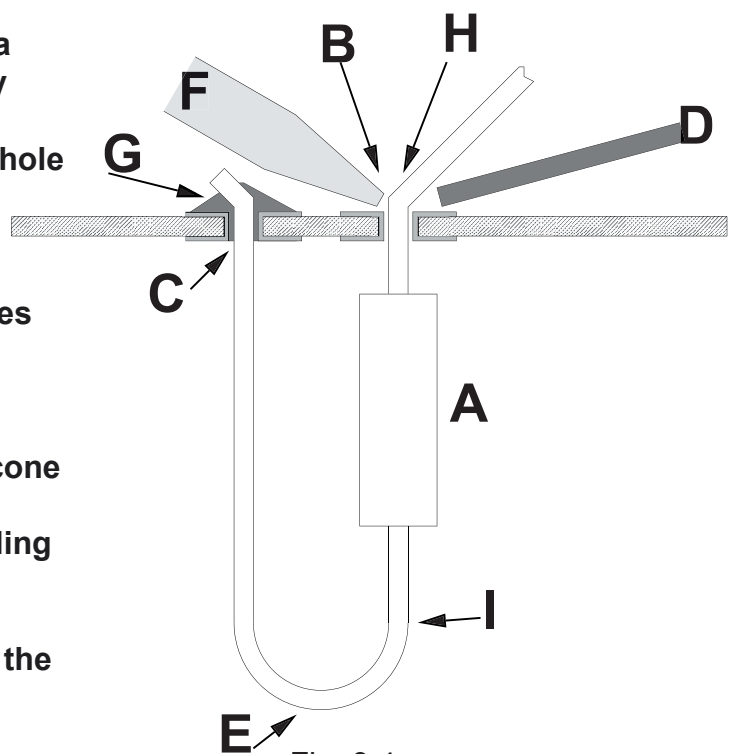

Fig. 3.4:
Creating a neat soldering connection

3.3. Soldering parts

After preparing the legs, parts are to be fitted in the metallized holes of the printed circuit board (PCB) and – for parts with only two or three legs – to be spread. Bending the leg at the backside of the PCB will prevent parts from falling down. For parts with more legs – eg. the sockets for ICs – bending two opposite legs on a diagonal line will suffice completely.

After fixing a part, apply some heat with the soldering tip to the leg and the soldering pad simultaneously. At the same time you will have to add a small quantity of solder. While melting, the solder will flow into the metallized hole. Add some more solder until the hole is filled completely (see fig. 3.4). Now remove the solder and then the soldering iron. Do not move the part or the PCB until the connection has chilled and become rigid. Moving parts while chilling will result in unreliable contacts, causing intermittent failures.

Bad soldering contacts may be recognized by ball-shaped slugs of solder around a pad or a mat surface (for lead-less solder the surface will even be extremely mat) and must be re-soldered.

To insert sockets and other parts for horizontal mounting on the PCB you may use the following trick: First of all you just solder one leg of the part. Then you press the part down slightly, while heating the same soldering pad (**Caution: the part may become very hot**). The part will now settle to the surface of the board and remain in a fixed position. You now solder all other contacts. Finally re-solder the first contact again with some extra solder.

After soldering a part the outstanding wires of the legs are to be cut off with a pair of pincers. Cut the legs off closely to the PCB, while taking care not to pull or push the legs.



Be careful for sharp-edged pieces of wire flying around while cutting the legs. Vertically mounted parts of course are not allowed to make contact to neighbors and must be bent apart if they have been placed too close.

3.4 De-soldering

When, occasionally, a part has landed on a spot where it does not belong then you have to remove such a part. The ASURO - as you could expect - has a double sided PCB with trough metalized holes, this makes the removal of the parts not very easy.

The following may be some help for you;

Add some flex to the soldering of the part which must be removed (a simple way of doing this is to add some extra solder). When all the solderings of the part are heated try to remove the part with a plier from the PCB. At the end you can easily remove the solder with desoldering wick.

Put the soldering wick on the solder(pad) [see, step 1 & 2, below]. You may also do this when the part is still in the PCB! Heat the wick and the solder together. At some point the wick will suck the solder into the copper braid. At this point, REMOVE the soldering iron and wick quickly.

You may repeat this on the other side of the hole when there is still solder in it.

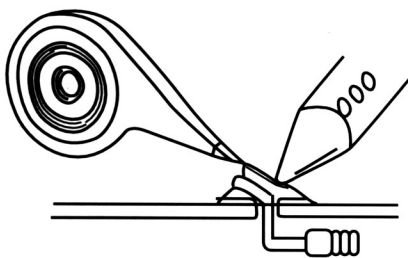

Step 1

Put the copper braid over the solder(pad) of the component which must be removed. Heat the braid and the solder(pad), the braid will now suck the solder.

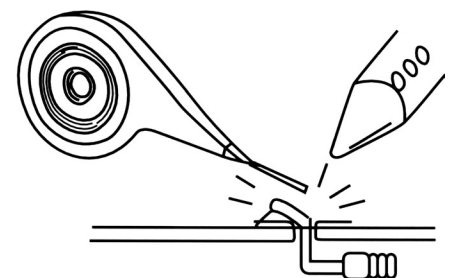
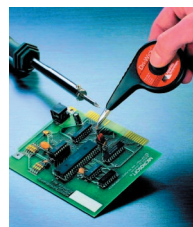

Step 2

Remove the soldering iron and copper braid at the same time.

4. Electronic assembly

Did you read the soldering instructions? Really? Well OK, let's go!

4.1. Assembling the RS232 infrared-transceiver

- IC1: Initially insert the 8-pole socket. The polarity mark of the (slightly asymmetrical) socket must correspond to the mark in the accompanying symbol on the PCB.
- D1, D2, D3: 1N4148, pay attention to polarity! Read the imprints of the parts and take care not to interchange with ZPD5.1 or BZX55-C5V1!
- D4: ZPD5.1 or BZX55-C5V1, pay attention to polarity! Read the imprints of the parts and take care not to interchange with 1N4148!
- D5: SFH-415-U IR LED (Black LED) pay attention to polarity, press downwards to the PCB
- C1: 100 μ F at least 16 volt, pay attention to polarity!
- C2, C4: 100nF ceramic capacitor, imprint: 104
- C3: 680pF ceramic capacitor, imprint: 681
- Q1: BC547 (A,B or C) or BC548 (A,B or C)
- R1, R5: 20k Ω (red, black, orange, gold)
- R2: 4.7k Ω (yellow, violet, red, gold)
- R3: 470 Ω (yellow, violet, black, gold)
- R6: 10k Ω (brown, black, orange, gold)
- R7: 220 Ω (red, red, brown, gold)
- TR1: 10K Ω variable resistor
- IC2: SFH5110-36 Infrared receiver IC, bend the legs with appropriate tongs! Pay attention to polarity (the curvature must be positioned to the outside)! Caution: electrostatic discharge (ESD) and excessive soldering or heating may damage the part!
- X1: 9pol. SUB-D connector, case must be settled close to PCB. Attachment strips must be soldered as well!
- IC1: insert the NE555P, pay attention to polarity!

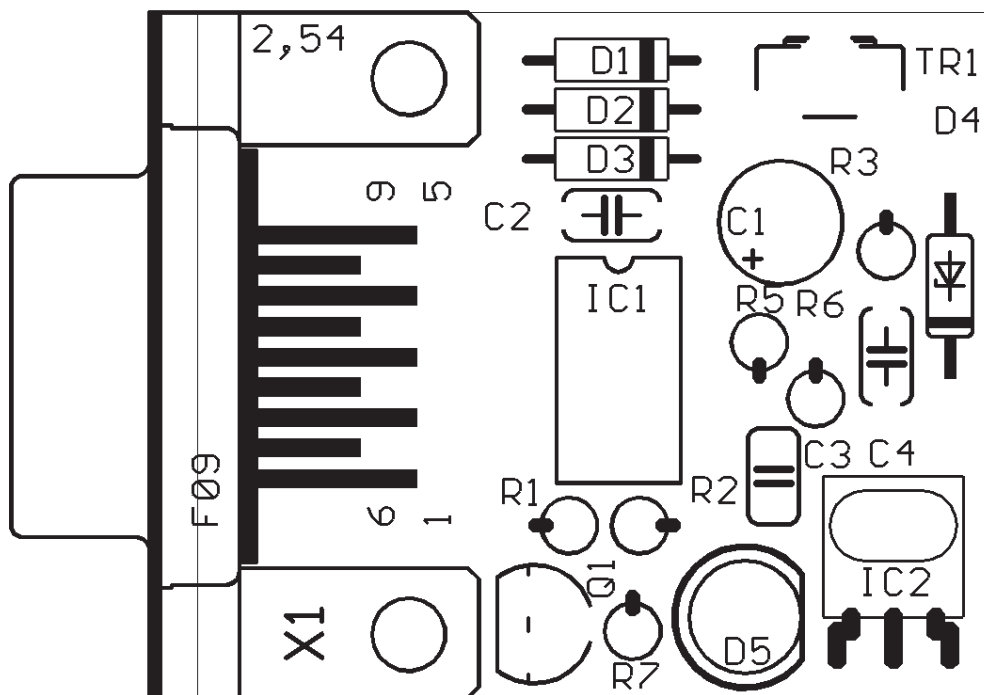

Finally check the board for short circuits or polarity errors. Check the soldering quality intensively and re-solder bad contacts.

Ready!

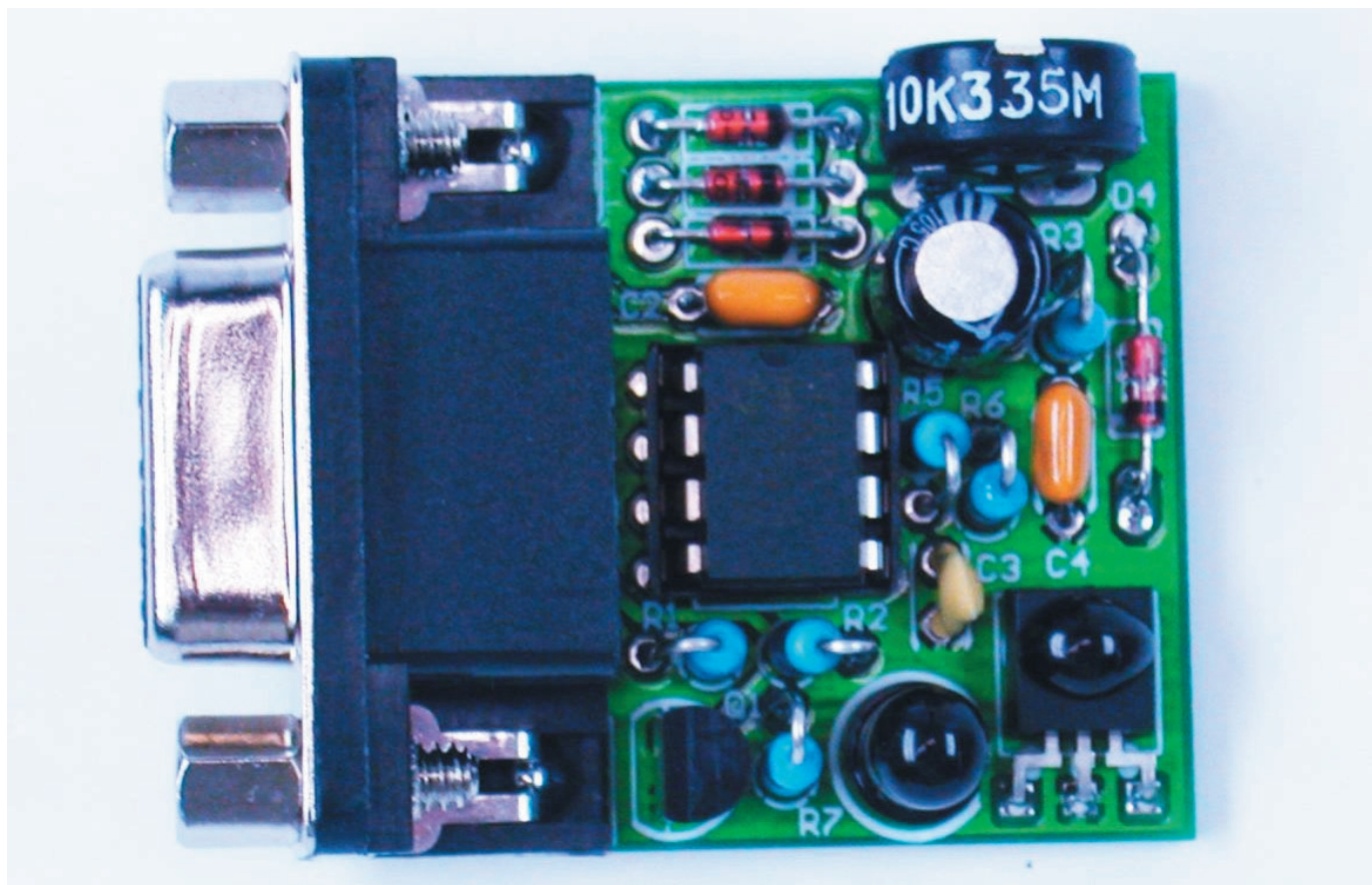

fig. 4.1.: Assembled IR-Transceiver

When the RS-232-IR-transceiver is ready assembled with the parts it will look like the above picture.

4.2. Assembled USB IR-transceiver

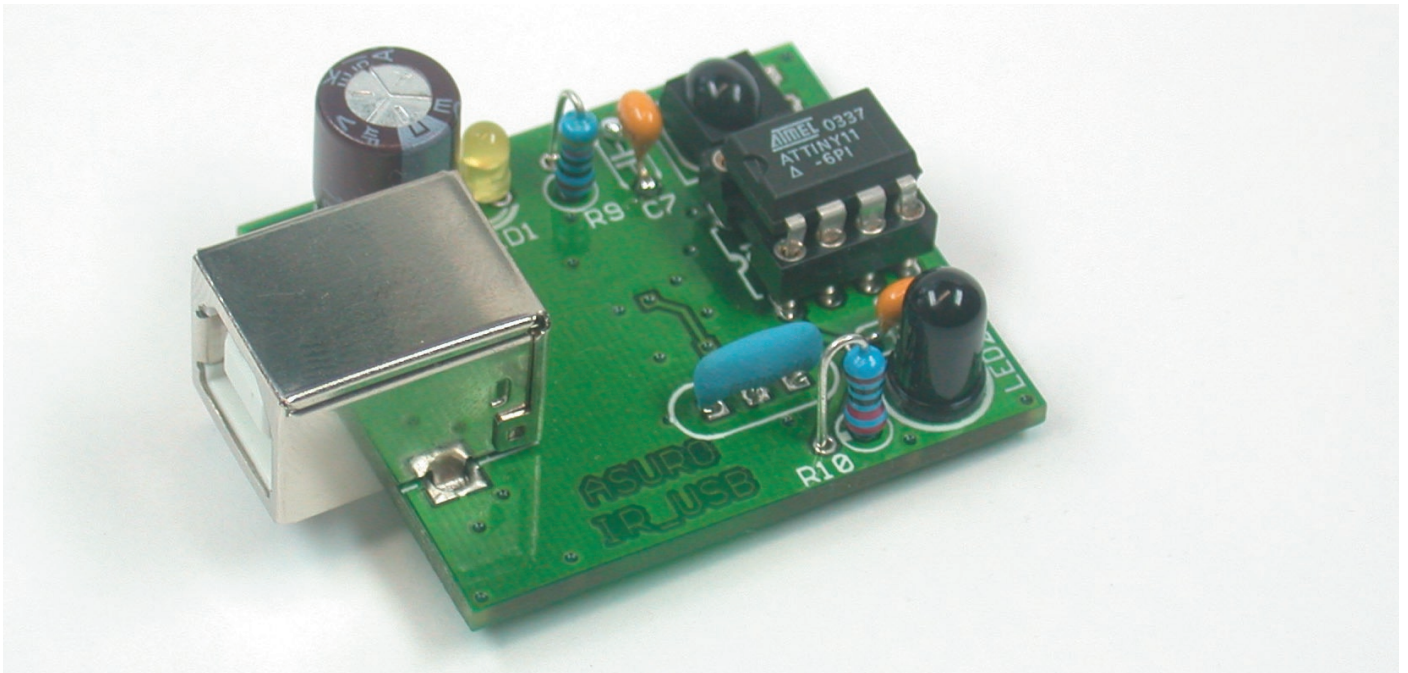

Fig. 4.2.: USB Infrared-Transceiver

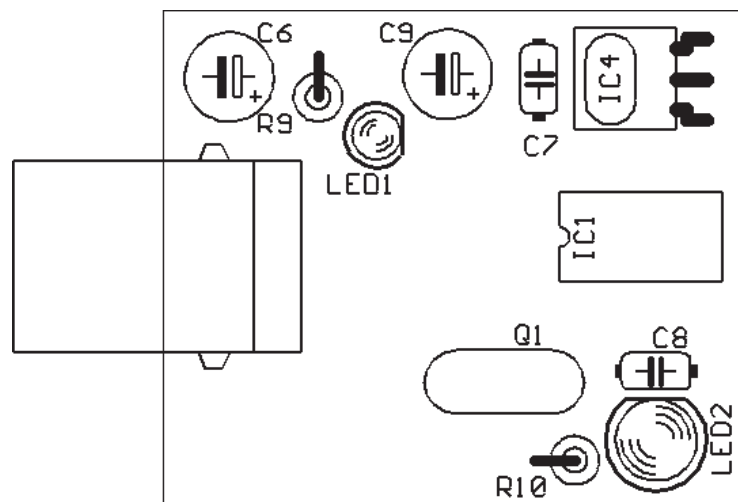

Fig. 4.3.: Component side USB Infrared-Transceiver

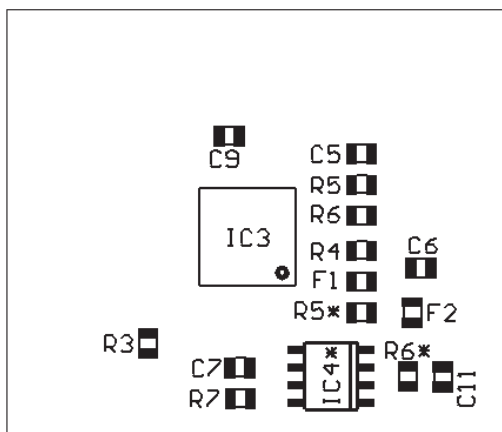

Fig. 4.4.: Bottom side USB Infrared-Transceiver

4.3. Inserting parts in the ASURO-PCB

The two longer axles, which will be needed for the second gear section are to be soldered or glued at the bottom-side of the PCB. Soldering is the best option, it hardens much faster than gluing and you always can easily correct it afterwards when necessary.

The two shorter axles have to be attached at the upper PCB-side nearer to the middle of the board. Before attachment, the axles must be cleaned at the soldering or glue-side (but not at the wheel-side) with some very fine sandpaper (corning number 240 or more), in order to improve adhesion of the solder respectively glue. If you choose soldering these parts, the following procedure should be followed:

First of all the longer axles will be attached. Put the PCB on a table with the bottom side upward and place the longer axle into the slide. Push it fully to the end of the slide. The axle should be laying flat at the length of the slide. Wet the soldering tip with some solder and press the tip onto the axle. After heating the axle you must add solder at the soldering pads beside the axles. After the soldering is finished, the soldering iron can be removed, while pressing the axle downwards with a screwdriver until the soldering connection is cooled off completely.

Repeat the procedure with the second long axle. Turn the PCB around and repeat the procedure with both short axles. Fig. 4.3 shows the PCB with four axles attached.

After a cooling phase the wheels may be attached to the axles. The cogwheels must fit exactly and the wheels are to rotate easily. If the wheels do not rotate easily, the axles might have been attached erroneously and you will have to repeat the procedure. In case some solder fractions should be attached to the surface of the axles in the wheel area, they must be removed by sandpaper or with a fine file.

If the wheels rotate easily, they may be removed and be put aside in order to place the electronic parts onto the PCB.

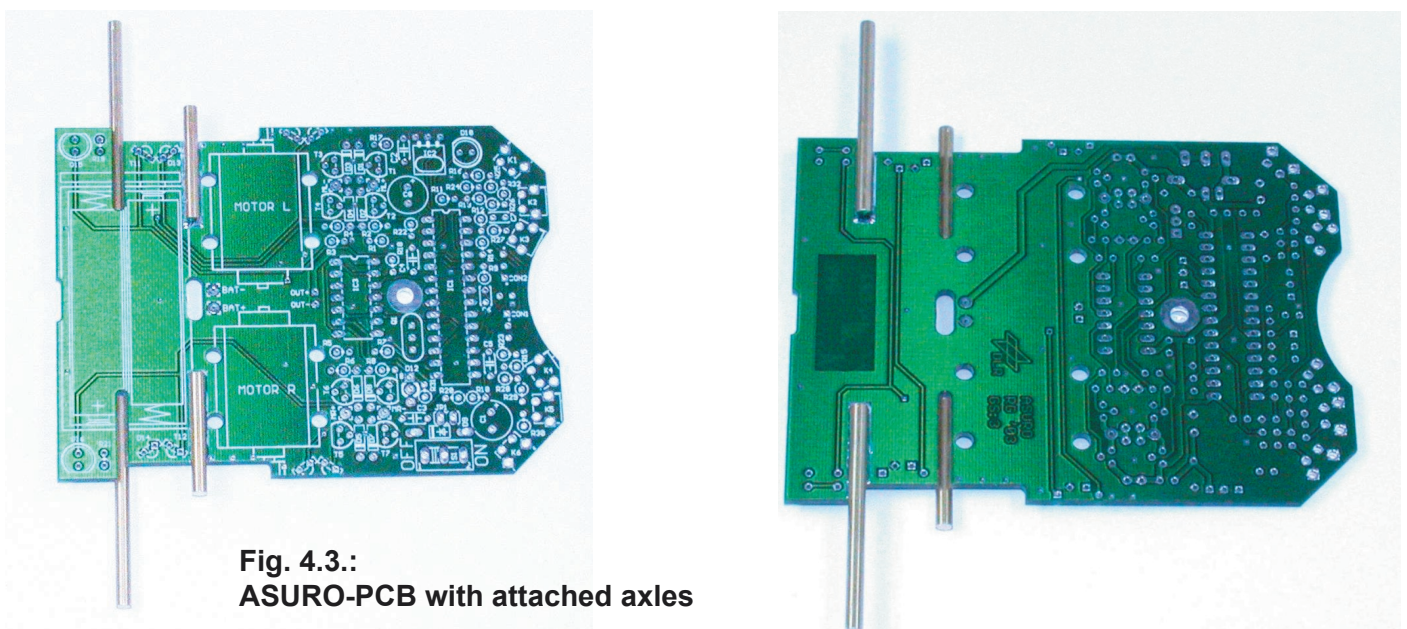

Fig. 4.3.:
ASURO-PCB with attached axles

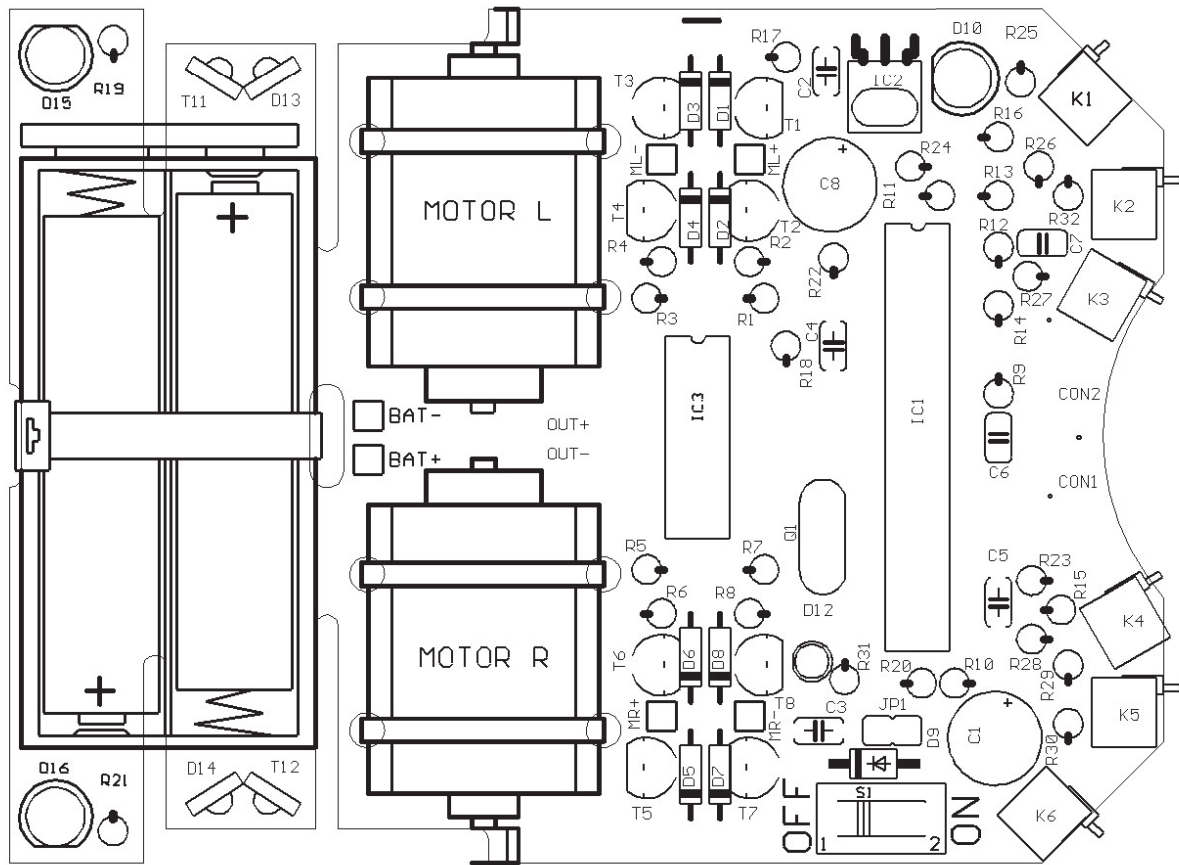

Fig. 4.2: Inserting parts view of upper-side to the main ASURO-PCB

The following inserting sequence may be used as a guideline:

- IC1: at first insert only the socket (either one Dual in line 28 pole-socket or two Dual in line 14 pole-sockets). Pay attention to polarity! A slight asymmetry is a mark for polarity in the socket and in the symbols on the PCB!
- IC3: Again insert only the socket (Dual in line 14 pole-socket). Pay attention to polarity! A slight asymmetry is a mark for polarity in the socket and in the symbols on the PCB!
- K1, K2, K3, K4, K5, K6: Sensor-switches, which must be mounted flat to the PCB surface!
- Q1; Resonator 8MHz
- D1, D2, D3, D4, D5, D6, D7, D8: Diode 1N4148; Pay attention to polarity!
- D9: 1N4001; Pay attention to polarity!
- JP1: Jumper; Short pins will be soldered, do not yet apply the jumper connector element!
- D12: Dual colored LED, 3 mm diameter, three legs ; Pay attention to polarity! (polarity may differ from part to part, however: the shortest leg must be inserted into the square soldering pad)!
- C2, C3, C4, C5: 100nF Ceramic; Imprinted: 104
- C6, C7: 4,7nF Ceramic; Imprinted: 472

Electronics

- T1, T3, T5, T7: BC327-40 or BC328-40
- T2, T4, T6, T8: BC337-40 or BC338-40
- R1, R2, R3, R4, R5, R6, R7, R8, R19, R21, R24: 1k Ω (brown, black, red, gold)
- R9, R16: 220 Ω (red, red, brown, gold)
- R10, R17, R22, R31: 470 Ω (yellow, violet, brown, gold)
- R11: 100 Ω (brown, black, brown, gold)
- R12: 12k Ω (brown, red, orange, gold)
- R13: 10k Ω (brown, black, orange, gold)
- R14, R15: 20k Ω (red, black, orange, gold)
- R18, R20: 4,7k Ω (yellow, violet, red, gold)
- R23: 1M Ω (brown, black, green, gold)
- R25, R26, R32: 2k Ω (red, black, black, brown, brown)
- R27: 8,2k Ω (grey, red, black, brown, brown)
- R28: 16k Ω (brown, blue, black, red, brown)
- R29: 33k Ω (orange, orange, black, red, brown)
- R30: 68k Ω (blue, grey, black, red, brown)
- C1, C8: Elco 220_F 10V or higher values; Pay attention to polarity!
- IC2: SFH5110-36 Infrared-receiver-IC, bend the legs with long-nose pliers!
Pay attention to polarity (the side with dome-shaped curvature must be positioned to the outside)! Caution: electrostatic discharge (ESD) and excessive soldering or heating may damage the part!
- D10: SFH 415-U IR-LED 5mm; black case; Pay attention to polarity! Case must be settled close to PCB.
- T11, T12: LPT80A, Phototransistor, colorless case;
Case must be settled close to PCB; Pay attention to polarity!
- D13, D14: IRL80A, IR-LED, rosy case;
Case must be settled close to PCB; Pay attention to polarity!
- D15, D16: LED 5 mm red, rosy respectively red case. Pay attention to polarity (short leg must be inserted at the mark)!
- S1: On/Off-Switch

Electronics

Three more parts will be needed (which will be used to follow a line), but they will be placed at the bottom side of the PCB and have to be soldered from the upper side (see fig. 4.5):

- T9, T10: SFH300, Phototransistor 5 mm; Pay attention to polarity! These components have to be placed at some distance from the PCB.
- D11: LED 5 mm red, red or reddish case; Pay attention to polarity! (short leg must be inserted at the mark)!

Fig. 4.6 gives an overview of the PCB with all parts inserted up to this phase in top view and in bottom view.

That's all! We will need no other electronic components.

In the next steps we will place electromechanical components and mechanical parts.

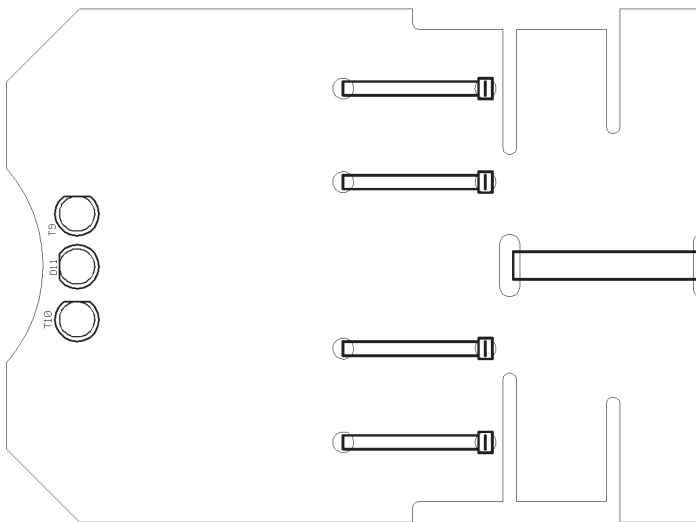

Fig. 4.5.:
Inserting parts at the bottom side of the ASURO-PCB

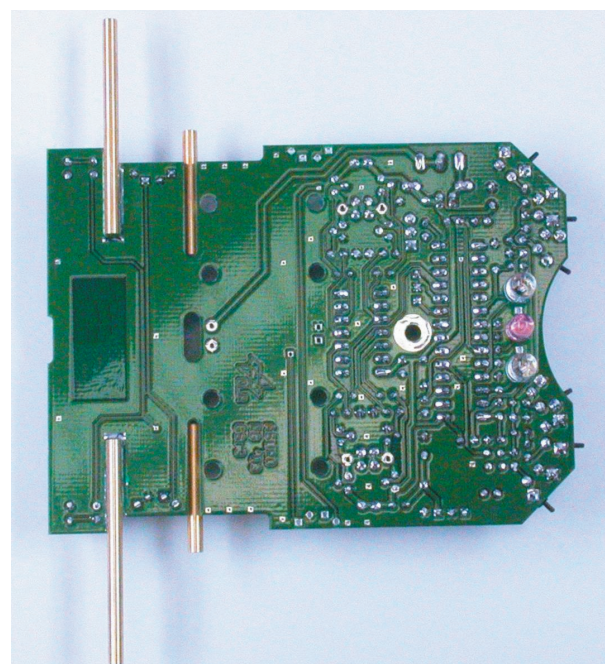
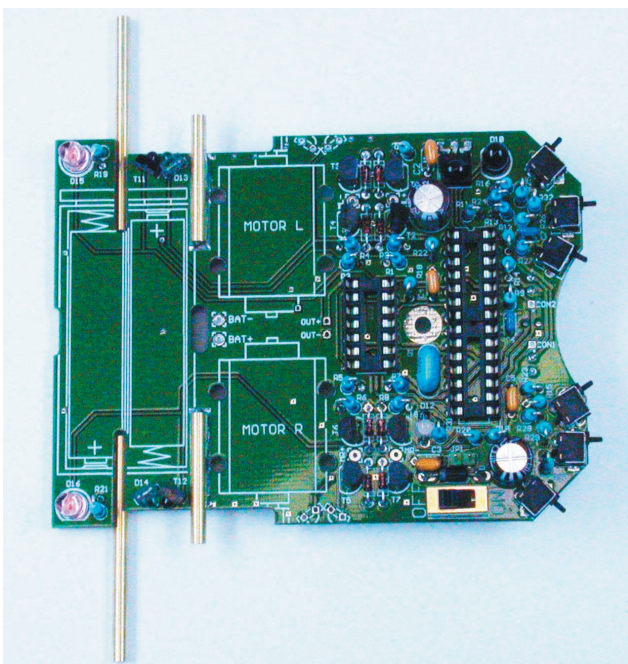

Fig. 4.6.: ASURO top side and bottom side, completely equipped

4.4. Attachment of the motors

After completing the insertion of the parts on the ASURO-PCB, we must supply the motors with cabling and attach these parts temporarily for some tests.

To supply electrical energy to the motor, we need 70 mm red and black wire for each terminal. These four wires for two motors have to be stripped at both ends for around 4 mm. The ends of the wires have to be twisted and pre-soldered with some solder. Any surplus parts of solder attached at the end of the wires may be cut off with a diagonal cutter. By soldering, we attach the red wire to the motor terminal, marked with a dot or a plus-sign. The black wire will be attached to the other terminal.

The wiring for the motors may be twisted (not necessary, but it will diminish sensitivity for electromagnetic disturbances and it looks much better...).

The red wire of the motor on the left side must be soldered into the “ML+”-port, the black wire into the “ML-”-port, the red wire of the motor on the right side must be soldered into the “MR+”-port, the black wire into the “MR-”-port.

Next we have to attach the motors temporarily to the PCB by cable-tiers. Use two holes to insert the supplied cable-tiers. In the first phase it will be sufficient to attach the two inner cable-tiers only.

4.5. Power supply



If ASURO is to be equipped and operated with batteries, you must open Jumper JP1 at any rate! If you decide to use rechargeable devices, the jumper has to be closed. Reverse placement of power cells with a closed jumper will destroy electronic parts!

Solder the red wire of the battery-holder into the “BAT+”, and the black wire into the “BAT-“ terminal. Check and be sure the ON/OFF-switch is in the OFF-position. Place the four power cells, correctly polarised, into the battery-compartment. Right now or after completing all tests, the battery-compartment must be attached to the PCB by inserting the larger cable-tie in the PCB-hole.

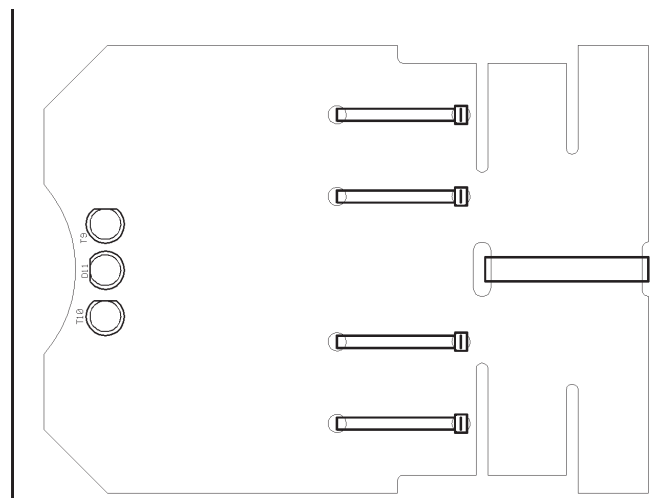
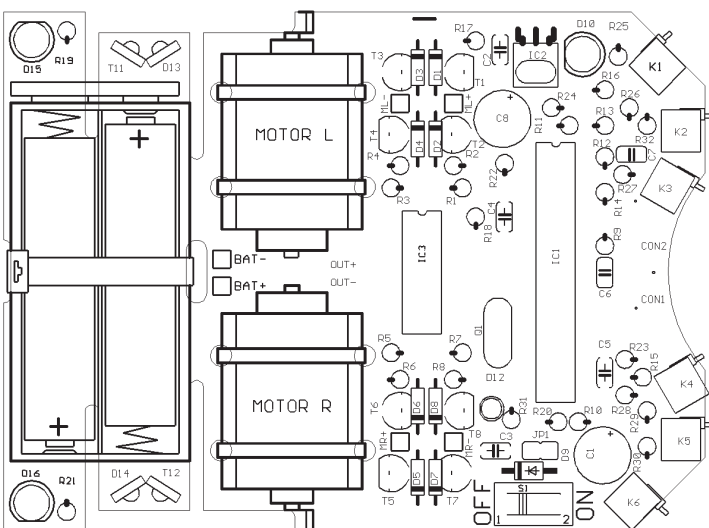

Fig. 4.7. Top and bottom view of the PCB

5. Preparation for operation

After completing the assembly we will start moving the robot. But first we will have to find and eliminate the errors we could have made in the previous phase, without destroying any parts.

5.1. RS232-Infrared-Transceiver

The following operational check is limited to the RS232-Infrared-Transceiver (Fig. 4.8).

First of all the IR-Transceiver must be checked, as it will be needed for the next step: the selftest of the system. For this test connect the IR-Transceiver to a free serial interface of your PC with the supplied 9-pole serial extension cable and start the Windows terminal program "Hyperterminal" (or for a Linux-system eg. "Minicom"). Normally you will find this program in Windows in the category Addons --> Communication --> Hyperterminal. If the program is not available, you can install it from the Windows-CD.

After starting the Hyperterminal program you will be asked to define a name for the connection. You may choose ASURO or any other symbol. In the next window you choose "connect by" and the COM-interface by which the transceiver has been connected in the previous step.

Then press "OK" and choose the following settings:

- Bits pro Second: 2400
- Databits: 8
- Parity: none
- Stopbits: 1
- Flowcontrol: none

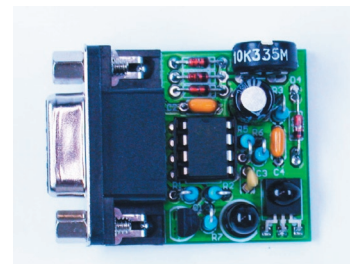

Fig. 4.8. RS-232 IR-Transceiver

Press "OK" again for confirmation

Hold the IR-Transceiver at the distance of 10 cm over a white sheet of paper. The component side must be directed towards the paper sheet.

Press a few keys at your computer terminal.

The terminal programm normally should display the key-symbols. The IR-Transceiver transmits the key-symbols by IR-Diode (D5), the transmitted signal reflects at the paper surface and is send back to receiver-IC (IC2), from which it is being returned to the computer. If no symbols or wrong symbols are being displayed you may carefully turn the trimmer between its extreme left and right positions. Use a miniature screwdriver and strike a few keys at each position of the trimmer until the correct symbols are displayed.

If you do not have any success in this procedure, we do have a problem with the circuit, which should be solved (see paragraph 6.1).

Just to be sure you should remove the IR-Transceiver after this test and hit a few keys. This time the display is now expected to show no symbols any more.

5.2. USB-Infrared-Tranceiver

This operation is only for the USDB IR-Tranceiver.

WARNING! The USB IR-Tranceiver does not have a housing and therefore it is very sensitive for electrostatic discharge. Before you use it, discharge your body by touching a metal computer housing or other earth point. An other option is to build the USB IR-Tranceiver in a transparant housing for further protection.

5.2.1 Windows

The following operational check is limited to the USB Infrared-Tranceiver.

First of all the IR-Tranceiver must be checked, as it will be needed for the next step: the selftest of the system. For this test connect the IR-Tranceiver to a free USB port of your PC by a USB extension cable.

Now a message will appear "NEW HARWARE WAS FOUND";

AREXX ASURO USB-IR-TRANSCEIVER

Now you can install the USB driver from the ASURO CD. When the driver is not detected automatically you can select it from the CD manually from CD\windows\USB Driver, (Administrator rigths are necessary for this operation). When the driver is installed you can approach the USB transceiver like a normal serial port.

After starting the Hyperterminal program you will be asked to define a name for the connection. You may choose ASURO USB or any other symbol. In the next window you choose "connect by" and the COM-interface by which the transceiver has been connected in the previous step.

Then press "OK" and choose the following settings:

- Bits pro Second: 2400
- Databits: 8
- Parity: none
- Stopbits: 1
- Flowcontrol: none

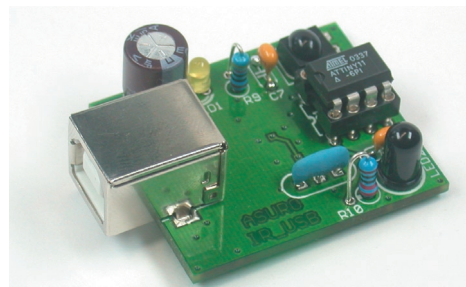

Press "OK" again for confirmation

Hold the IR-Tranceiver at the distance of 10 cm over a white sheet of paper. The component side must be directed towards the paper sheet.

Press a few keys at your computer terminal.

The terminal programm normally should display the key-symbols. The IR-Tranceiver transmits the key-symbols by IR-Diode (D5), the transmitted signal reflects at the paper surface and is send back to receiver-IC (IC2), from which it is being returned to the computer. If no symbols or wrong symbols are being displayed you may carefully turn the trimmer between its extreme left and right positions. Use a miniature screwdriver and strike a few keys at each position of the trimmer until the correct symbols are displayed.

If you do not have any success in this procedure, we do have a problem with the circuit, which should be solved (see paragraph 6.1).

5.2.2 Linux

The following operational check is limited to the USB Infrared-Tranceiver and LINUX software. First of all the IR-Transceiver must be checked, as it will be needed for the next step: the selftest of the system. For this test connect the IR-Transceiver to a free USB port of your PC by a USB extension cable. A short beep will confirm that the transceiver was detected by the LINUX software. To be sure please check in the proc-declaration if the following message is displayed.

```
foo@bar:~>cat /proc/tty/driver/usb-serial
```

There is also an entry with the following ('0' in our example can also be '1' or '2' etc.):

```
usbserinfo:1.0 driver:v1.4  
0: module:ftdi_sio name:"FTDI 8U232AM Compatible" vendor:0403 product:6001  
num_ports:1 port:1 path:usb-00:11.2-1
```

For test you have to configure the Minicom at the interface /dev/ttyUSB0 (oder 1, 2 usw...) with the following settings:

- Bits pro Second: 2400
- Databits: 8
- Parity: none
- Stopbits: 1
- Flowcontrol: none

Press "OK" again for confirmation

It is possible that root rights are necessary.

Maybe you need to declare read and write rights for the user or groups for the new device /dev/ttyUSB?. You can do this with `chmod u+rw /dev/ttyUSB0` (oder 1, 2...) or `chmod g+rw /dev/ttyUSB0` (of course again you need the root.ricgts).

Hold the IR-Transceiver at the distance of 10 cm over a white sheet of paper. The component side must be directed towards the paper sheet.

Press a few keys at your computer terminal.

The terminal programm normally should display the key-symbols. The IR-Transceiver transmits the key-symbols by IR-Diode (D5), the transmitted signal reflects at the paper surface and is send back to receiver-IC (IC2), from which it is being returned to the computer. If no symbols or wrong symbols are being displayed you may carefully turn the trimmer between its extreme left and right positions. Use a miniature screwdriver and strike a few keys at each position of the trimmer until the correct symbols are displayed.

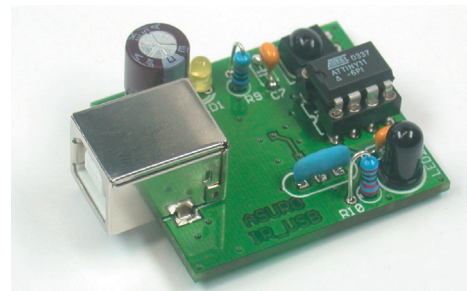

5.3. ASURO operation



Caution: The processor (IC1) is not to be inserted yet!

Now be careful and turn the main switch ON. Both back-LEDs (D15, D16) should be glowing dimly. If they do not glow dimly, please switch off the system immediately and continue reading in chapter 6.3. If you are successful, switch the system OFF and insert IC1 (Processor) and IC3 (AND Gate) (see fig. 5.1).

Sometimes the legs of an IC have to be bent carefully in order to insert all legs into the contact holes of the socket. This can be done easily if you take the IC and press the side with all legs on the row parallel on the surface of a flat table.



Processor IC1 ATmega8 and Gate IC3 CD4081 both are electrostatically sensitive devices. They might be destroyed by touching them, if you do have charged yourself electrostatically, which may easily occur by walking over a non-conductive floor. Before working with these parts, it is a good idea to wear a grounding bracelet or at least to touch a metallic case of grounded equipment or a heating radiator.

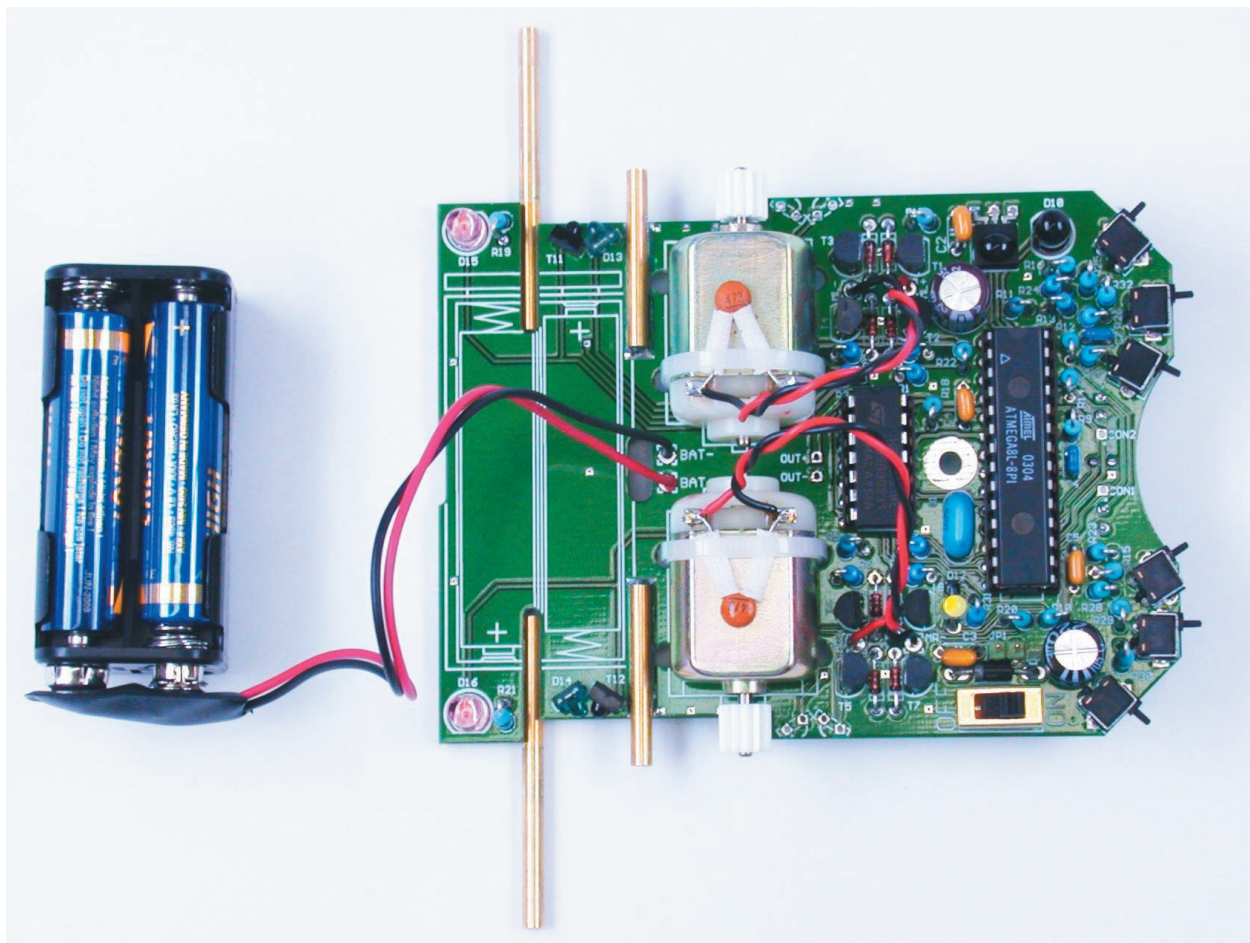

fig.5.1.: ASURO after installing the ICs

Now insert the Jumper (J1) for rechargeable devices. The polarity marks of the ICs must align with the marks of the sockets and the marks on the PCB. The processor has been designed to do a selftest and it will check all components on power up. Just to avoid any difficulties in this phase, you are advised to read the next chapter completely before switching power ON and then return to this chapter. At this point we start testing. Switch the power ON and keep your eyes fixed to the ASURO from now on.



When the program Hyperterminal (Windows) or minicom (Linux) is active and there is a visible contact between ASURO and the Infrared-Transceiver it is possible to follow the self test on you computer screen.

5.3.1. Display-elements

The Status-LED (D12) shortly lights orange and the “Back-LEDs” (D15, D16) also glow, but these glow only dimly. If one of these signs does not show, switch OFF immediately and start error checking and removal (see paragraph 6.3.3). You just have seen the boot-sequence of ASURO. In the next phase all display-elements will be checked subsequently at a distance of 3 seconds and in the following order:

- Status-LED (D12) green
- Status-LED (D12) red
- Front-LED (D11) at the bottomside of the ASURO
- Back-LED (D15) left
- Back-LED (D16) right
- All display-elements together

If an error occurs, switch OFF ASURO immediately and start error checking and removal (see paragraph 6.4.), as all display elements play an important role for all following tests.

5.3.2. Phototransistors (T9, T10)

After finishing the display tests the Status-LED (D12) should light in green, indicating clearly the Phototransistors at the bottomside of ASURO and responsible for line tracing, are now being tested for about 10 seconds.

While lighting the Phototransistors (T9, T10), the accompanying Back-LEDs (D15, D16) will be turned on and dim as soon as the light is switched off (right phototransistor(T10) → right back-LED (D16); left phototransistor(T9) → left back-LED (D15)). Everything is OK, if the back-LEDs do not go out completely after removing the light and continue glowing dimly. Even in case an error is found, the selftest may be continued and the error removal may be postponed.

5.3.3. Switches

ASURO is immobile and all displays are dark. That is a good omen! Now we are ready to check the switches for about 15 seconds. Just hit the switches, to see if something happens.

The result should be:

- K1 → Status-LED (D12) is switched on green
- K2 → Status-LED (D12) is switched on red
- K3 → Front-LED at the bottom side is switched on
- K4 → Back-LED left (D15)
- K5 → Back-LED right (D16)
- K6 → Motor left starts running (If the motor does not start running, the selftest may be continued. The motors will be checked separately later and an error in this segment may be removed in the tests described in chapter 6.8).

Pressing several switches will initiate an equivalent combination of signals. On errors the selftest may be continued. Error removal may be postponed.

5.3.4. Odometer

Now the linetracer-LED (D11) starts lighting. This signal indicates the beginning of the next test (15 seconds), in which both odometers (each consisting of a LED and a phototransistor) are being checked. Holding a white sheet of paper in front of the sensors will result in lighting the status-LED. First of all hold a sheet of paper in front of the left sensor (T11). → Status-LED (D12) lights green. Then hold a sheet of paper in front of the right sensor (T12) → Status-LED (D12) lights red. Removing the sheet will result in switching off the status-LED. If the on/off-thresholds are active on the left and on the right side, the odometers are OK. If an error occurs, the selftest may be continued anyway. Error removal may be postponed.

5.3.5. The engine

Both back-LEDs (D15, D16) are switched on, indicating the last test, which lasts ca. 15 seconds. The motors will be checked intensively. The left motor is started in forward direction from zero speed to maximum speed and back to zero again. Then the direction will be reversed and speed is accelerated from zero to maximum and back again to zero. The motor on the right side will be checked the same way. After checking the single motors both will be checked simultaneously. Again we will repeat the remarks only once more: If an error occurs, the selftest may be continued anyway. Error removal may be postponed.

5.3.6. IR interface

If the status-LED lights intermittently yellow, the last test has been started (ca. 15 seconds), in which the IR interface transmits and receives data. In order to receive these data, the previously assembled IR-Tranceiver has to be connected to the PC and a terminal program, eg. the Windows terminal program "Hyperterminal" may be used for this purpose. The configuration will be the same as at the testprocedure for the IR-Tranceiver.

At the receipt of symbols, ASURO will answer with a symbol next following in the alphabet. If within a fixed time limit no symbols have been received, ASURO transmits a 'T'. Any sent symbol will switch on the RED status-LED parallel to the green status-LED, which results in an orange flashing colour.

If an optical connection between ASURO and the Infrared-Transceiver has been arranged (which requires a maximal distance of ca. 50 cm), the terminal program will show up a symbol 'T' regularly or alternatively the button you may have activated at the PC's keyboard (as it has been transmitted by the transceiver), followed by the symbol next in the alphabet, eg.:

- Key "e" is activated → terminal program reports "ef"
- Key "j" is activated → terminal program reports "jk"
- Key "3" is activated → terminal program reports "34"

In case of errors see chapter 6.9.

5.3.7. ready ?

If an error has occurred, switch the system OFF and remove the batteries. Trace and eliminate the error by methods in chapter 6 . Repeat the selftest to see if no component has been damaged. Only a completed and errorfree selftest will guarantee the ASURO hardware is OK and that any other errors will have to be found in the software.

If you have to check the hardware after you have installed other programs in ASURO, the selftest program "SelfTest.hex" has to be reloaded and programmed from CD.

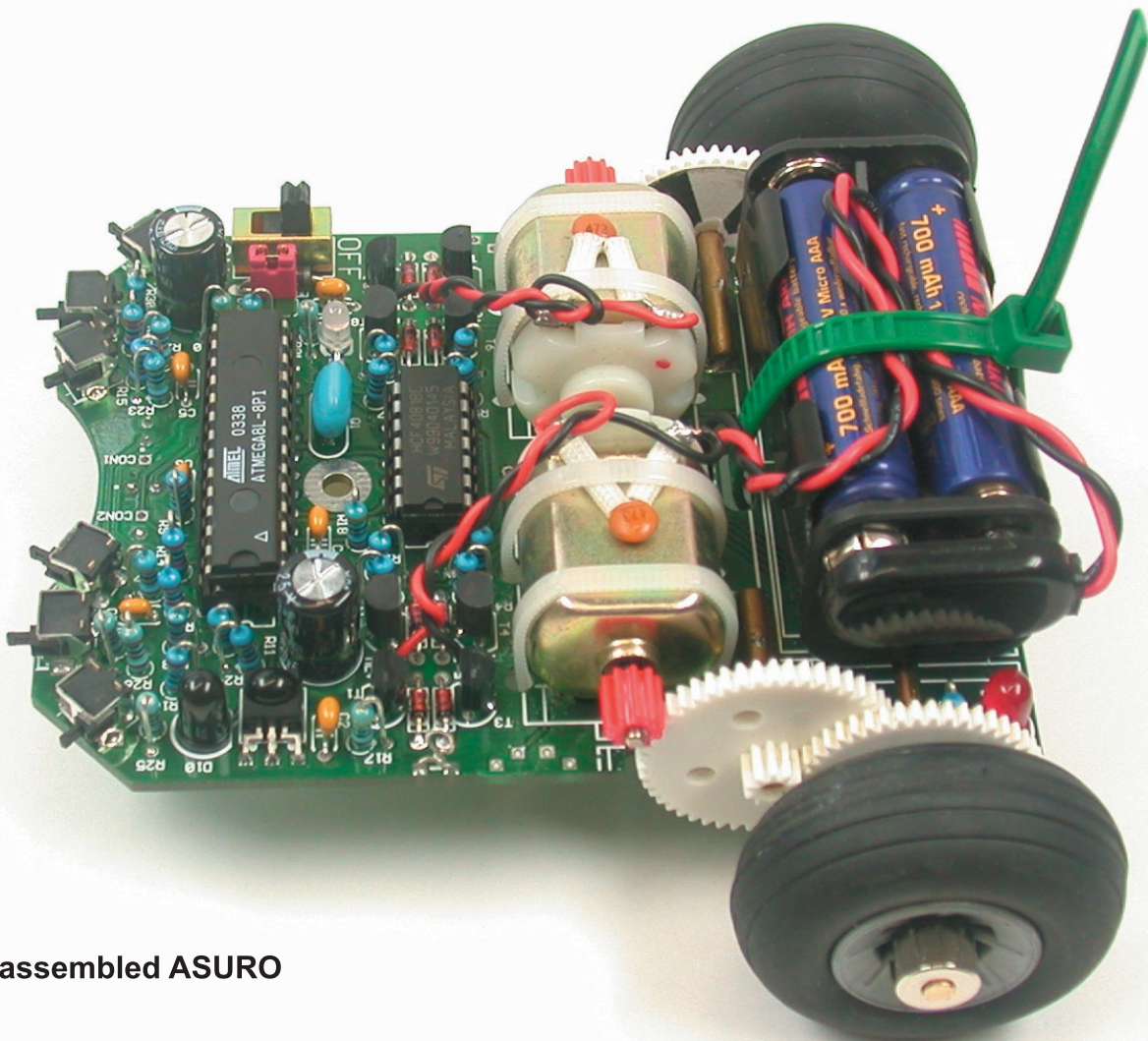

Fully assembled ASURO

6. Error tracing

6.1. Failure of the RS232-IR-transceiver

6.1.1. Activated key and displayed symbol do not match

Calibrate Trimmer TR1 until activated key and displayed symbol do match.

6.1.2. The terminal program does not display any symbol

Has the timer-IC (IC1) been inserted and has it been inserted correctly polarized (the mark must point to the three diodes) ? Take any infrared remote control of a HIFI- or video-equipment (videorecorder, TV, etc) and point it to the IR-transceiver, pressing a few keys. If the terminal program displays irregular symbols, the receiver (IC2, R3, C4, D4, T1) is operating. All other parts have to be checked.

6.1.3. Still not working

Check all parts for correct polarisation and correct value (see fig. 4.1). Check soldering connections for short circuits and bad soldering. Has a soldering pad been disrupted ? If all checks have been made without results, the bad part has to be traced with the help of the schematic (see Appendix B) and an adequate measurement device (multimeter or oscilloscope). (In most cases one of the components IC1, IC2, Q1, D4 may have been damaged).

6.2. USB-infrared-transceiver does not work

6.2.1 WINDOWS

Check if the drivers are installed correctly and if the correct com port is selected.

6.2.2 LINUX

Disconnect the USB transceiver... wait a minute and connect it again, this may solve the problem. An other option is to install a new kernel

6.3. Back-LEDs (D15,D16) do not glow at startup!

6.3.1. None of both back-LEDs is glowing

Please look very carefully in a darkened room. If no light can be seen, check the following steps:

- Have 4 batteries been inserted, are the batteries fresh or have they been charged anew?
- Did you connect the battery-cable correctly ? (red to Bat+ and black to Bat-)
- Has Diode D9 (1N4001) been inserted with correct polarity?
- Did you use the correct value for R22? 470 Ω (yellow, violet, brown, gold)
- Also check for R18, R19, R20, R21:
 - 4,7K Ω (yellow, violet, red, gold)
 - 1K Ω (brown, black, red, gold)

6.3.2. Only one of both back-LEDs is glowing

Did you insert the diodes (rose- or red-colored), D13 (left) ,D14 (right), and the phototransistors (transparent or black case) T11 (left), T12 (right) at the correct position and with the correct polarisation?

Check the value for resistors R18, R19 (left) and R20, R21 (right)?

4,7K Ω (yellow, violet, red, gold)

1K Ω (brown, black, red, gold)

Have these parts been inserted at the correct position? (check the imprint on the PCB!).

6.3.3. Status-LED (D12) is not activated bicolored after startup

Status-LED is not activated at all -> see [6.4!](#)

Status-LED flickers. Battery voltage is too low. Replace batteries.

If the batteries are fresh, check resistors R12 and R13.

12K Ω (brown,red,black,red,brown)

10K Ω (brown,black,black,red,brown)

6.4. A display element does not work

Has the processor been inserted correctly ? (Polarity!)

6.4.1. Status-LED D12 does not work

Check polarisation of LED D12.

Check resistors R10, R31

470 Ω (yellow, violet, brown, gold)

A simple check may be done the following way: remove the processor (IC1) and connect by wire Pin7 (VCC) and Pin14 (Status-LED will be activated green) respectively Pin4 (Status-LED will be activated red). If this test is succesful, (1) either the processor may be defective, or (2) a track of the PCB may be broken / interrupted.

6.4.2. Front-LED D11 does not work

Check polarisation of LED D11.

Check resistor R9

220 Ω (red, red, brown, gold)

A simple check may be done the following way: remove the processor (IC1) and connect by wire Pin7 (VCC) and Pin12 (Front-LED will be activated red). If this test is succesful, (1) either the processor may be defective, or (2) a track of the PCB may be broken / interrupted.

6.4.3. Left back-LED D15 does not work

Check polarisation of LED D15.

Check resistors R19, R18.

1K Ω (brown, black, red, gold)

4,7K Ω (yellow, violet, red, gold)

A simple check may be done the following way: remove the processor (IC1) and connect by wire Pin7 (VCC) and Pin24 (left back-LED will be activated red). If this test is succesful, (1) either the processor may be defective, or (2) a track of the PCB may be broken / interrupted.

6.4.4. Right back-LED D16 does not work

Check polarisation of LED D16.

Check resistors R21, R20.

1k Ω (brown, black, red, gold)

4,7k Ω (yellow, violet, red, gold)

A simple check may be done the following way: remove the processor (IC1) and connect by wire Pin7 (VCC) and Pin23 (right back-LED will be activated red). If this test is succesful, (1) either the processor may be defective, or (2) a track of the PCB may be broken / interrupted.

6.5. Linetracer sensor (T9, T10) does not work

Check polarisation of T9, T10.

Check resistors R14, R15.

20K Ω (red, black, orange, gold)

Check, if R15, R23 and R28 have not been inserted in a wrong position!

Check the sensor signal at Pin25 respectively Pin26 with a multimeter after removing the processor (dark \approx 0V, light \approx VCC).

6.6. A switch does not work

6.6.1. Obviously a combination of switches has been activated

Check R12 and R13

12K Ω , (brown,red,black,red,brown)

10K Ω , (brown,black,black,red,brown)

Check R24, R25, R26, R27, R28, R29, R30, R32 as well!

1K Ω (brown, black, black, brown, brown)

2K Ω (red, black, black, brown, brown)

8,2K Ω (grey, red, black, brown, brown)

16K Ω (brown, blue, black, red, brown)

33K Ω (orange, orange, black, red, brown)

68K Ω (blue, grey, black, red, brown)

2K Ω (red, black, black, brown, brown)

6.6.2. The display reacts as if switches have been interchanged

Resistors to the switches have been interchanged

Check R24, R25, R26, R27, R28, R29, R30, R32 as well!

1K Ω (brown, black, black, brown, brown)

2K Ω (red, black, black, brown, brown)

8,2K Ω (grey, red, black, brown, brown)

16K Ω (brown, blue, black, red, brown)

33K Ω (orange, orange, black, red, brown)

68K Ω (blue, grey, black, red, brown)

6.6.3. Things still do not work well

Check R23, R24. Check R12, R13 and check C7 as well!

1M Ω (brown, black, green, gold)

1K Ω (brown, black, black, brown, brown)

12K Ω , (brown, red, black, red, brown)

10K Ω , (brown, black, black, red, brown)

220 μ F/10V

6.7. The reflected light sensor (the odometer) does not work

6.7.1. None of the reflected light sensors (odometer) is working

Check resistor R22!

470 Ω (yellow, violet, brown, orange)

Check rotation of D13 and D14. D13 and D14 are rose- or grey-colored bipoled components with a small spot at one side. The spot must point to the outside of the PCB.

6.7.2. The left reflected light sensor (odometer) does not work

Check resistor R18!

4,7K Ω (yellow, violet, red, gold)

Check rotation of T11, which is a transparent or black bipoled component with a small spot at one side. The spot must point to the outside of the PCB.

6.7.3. The right reflected light sensor (odometer) does not work

Check resistor R20!

4,7K Ω (yellow, violet, red, gold)

Check rotation of T12, which is a transparent or black bipoled component with a small spot at one side. The spot must point to the outside of the PCB.

You may check the sensor signal at Pin24 respectively Pin23 after removing the processor.
(dark \approx VCC, light \approx 0V)

6.8. One motor does not move

6.8.1. Both motors do not move

Check polarity and position of IC3.

6.8.2. The left motor does not move or only in one direction

In this case the complete motor bridge, consisting of transistors T1, T2, T3, T4 (did you insert the correct transistors at the correct positions?), the diodes D1, D2, D3, D4 (polarity!) and resistors R1, R2, R3, R4.

BC327-40 or BC328-40, BC337-40 or BC338-40, BC327-40 or BC328-40, BC337-40 or BC338-40

1K Ω (brown , black, red, gold)

6.8.2. The right motor does not move or only in one direction

In this case the complete motor bridge, consisting of transistors T5, T6, T7, T8 (did you insert the correct transistors at the correct positions?), the diodes D5, D6, D7, D8 (polarity!) and resistors R5, R6, R7, R8

BC327-40 or BC328-40, BC337-40 or BC338-40, BC327-40 or BC328-40, BC337-40 or BC338-40

1K Ω (brown , black, red, gold)

6.8.4. One motor turns in the reversed direction

Check the cables, which connect the motor to the system. These connections should be interchanged.

6.9. IR-interface

6.9.1. ASURO does not send symbols

Check polarity of IR-Diode D10.

Check resistor R16 220 Ω (red, red, brown, gold)

6.9.2. ASURO does not receive symbols

You will need a line of sight between IR-Transceiver and ASURO (at a distance of max. 50 cm) and the IR-Transceiver must be checked and OK (see chapter 6.1).

Check position and polarity of C2.

Check resistor R17 and C2.

220 Ω (red,red, brown, gold)

100nF (imprint 104)

If you have not found the error yet, please remind the soldering of IC2. This component is sensitive to overheating and may have been damaged while soldering. In this case replace the component by a new IC (SFH 5110-36). When the transfer of data between PC and ASURO is malfunctioning again and again, re-adjust trimmer TR1 in the transceiver.

6.9.3. Things still do not work well

Check polarity of C8.

220 μ F/ at least 10V

If transfer of data between PC and ASURO is malfunctioning again and again, re-adjust trimmer TR1 in the transceiver.



Instant and bicomponent glues are suspected to cause irritant and allergic reactions at skin exposure. Any exposure to these materials must be avoided. Vinyl gloves may protect your hands. If protection fails, clean body parts intensively and immediately with soap and water! Instant glues originally have been developed for surgery, which may be noticed if your fingers are fixed together within seconds. If your fingers really are glued together by instant glue, you may loosen this fixture with warm water, soap and some patience. Be extremely careful not to touch your lips or eyelids with glue! Suppress all reflexes to wipe your face or your eyes while working with glues!

7. Final adjustments

Grease the axles slightly. Place the cogwheels with its fine black and white markings onto the short axles. The tires combined with the cogwheels are now placed onto the long axles and secured by a locking ring. Move the motor, which has been fixed temporarily, carefully until it has been adjusted properly, the cogwheels fit together properly and the transmission system runs smoothly.

(Run the selftest completely to see if the motors in the transmission are working well). If the position of the motor has been checked, keep the system tightly fixed while you put a small amount of instant glue between motor and PCB. Please remind the instant glue may take a few seconds to stir. After fixture with instant glue the cable ties are applied at the outside of the PCB.

The halved table-tennis ball is to be glued with instant glue as well to the bottomside of the PCB at two opposite positions, directly behind the linetracer-components (see fig. 7.1). Please remind again: the instant glue may take a few seconds to stir.

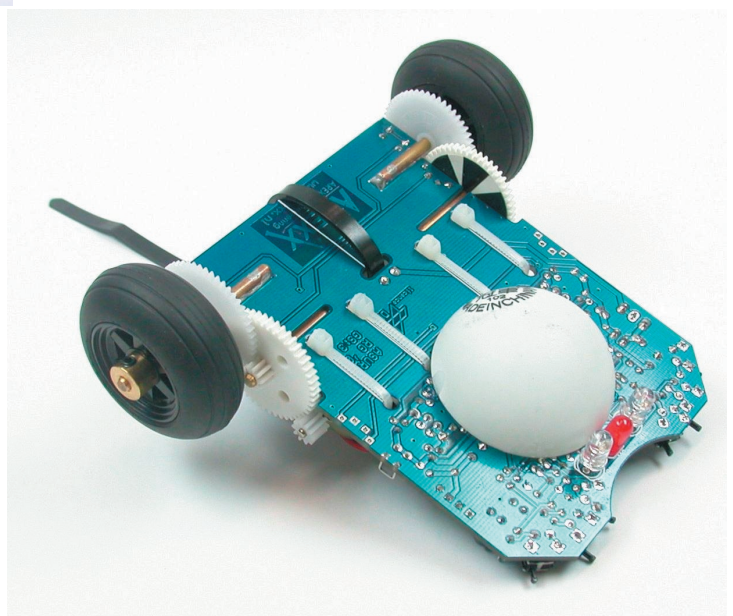
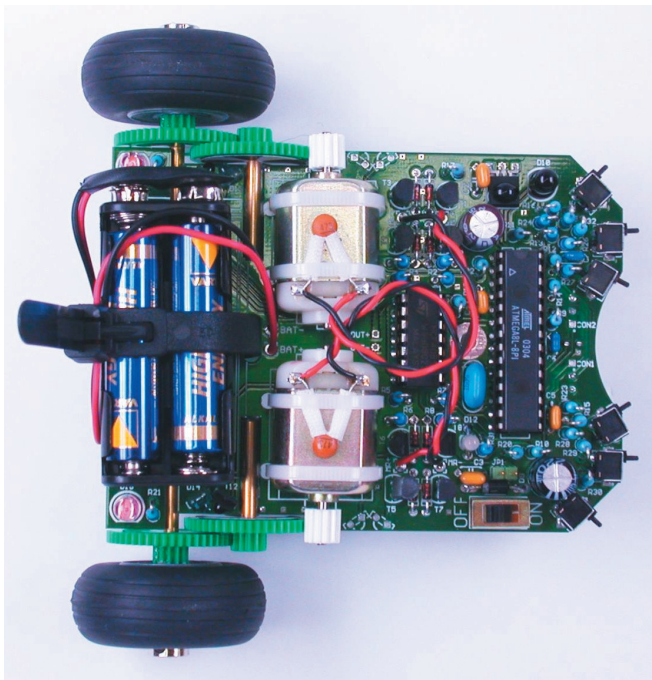

Fig 7.1.: ASURO completely assembled

PART III. Software

8. Software installation and initial steps

Insert the ASURO CD. When all is OK it will start automatically otherwise open it with windows explorer. After the language selection you will find all the programs you need for the ASURO under the software menu. Before you can work with them you have to install the program on your hard drive first. To install programs on your hard drive you need administrator rights, when you are not logged in as administrator log out and log on again as administrator.

During the software installation we will do the following things:

1. Flash-Tool, a program to transmit your own program to ASURO, will be installed.
2. A program editor (Programmers Notepad 2, PN2) and a Compiler (WinAVR) will be installed.
3. An example program(s) will be copied from CDRom to your hard disk.
4. We will create, in program editor (PN2), a menu input for Make and Clean files.

8.1 WINDOWS

8.1.1 FLASH tool

Copy the flash program in a folder on your hard drive for example C:\programs\flash. It is also possible to run the flash program directly from the CD. In all cases it is wise to make a link for the flash program on your desktop.



8.1.2 Installation of the program editor and compiler

For the installation of the compiler you must be the administrator of your computer (during the installation the registry will be changed). When you are not registered as the administrator restart the computer and start up as administrator!

Click on the install symbol to install.



COMPILER WinAVR (20030913)

When nothing happens try to open the CD with windows explorer.

Software

Now this screen will show up:

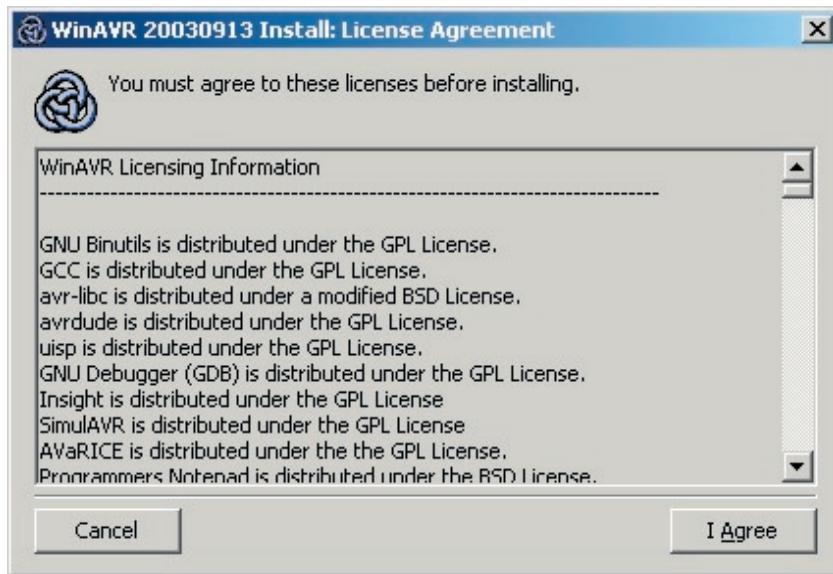

Click [I Agree]

This screen appears:

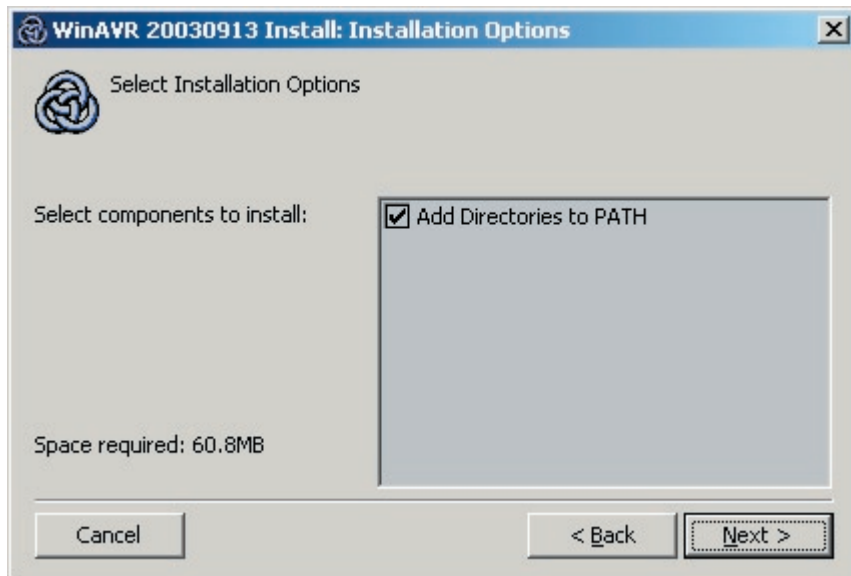

Click [Next]

Software

The next screen appears:

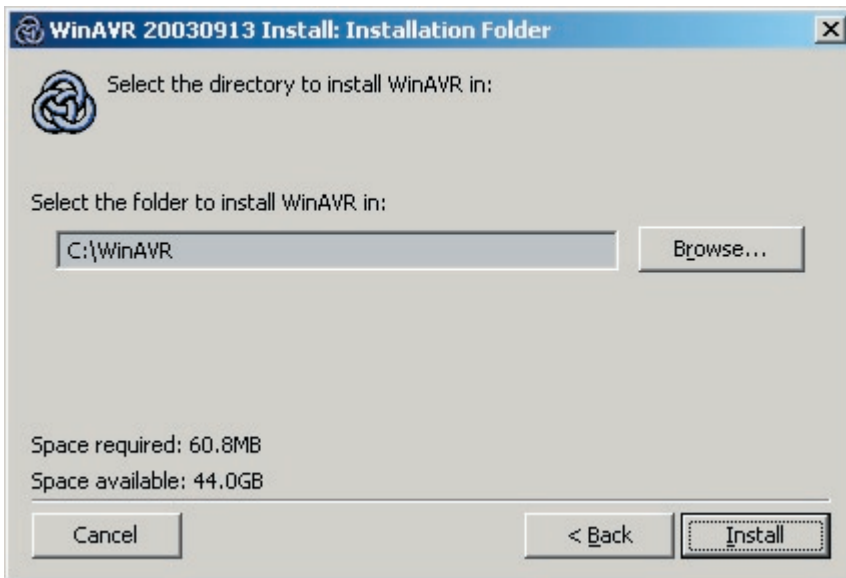

Click [Install]

and the next screen appears:

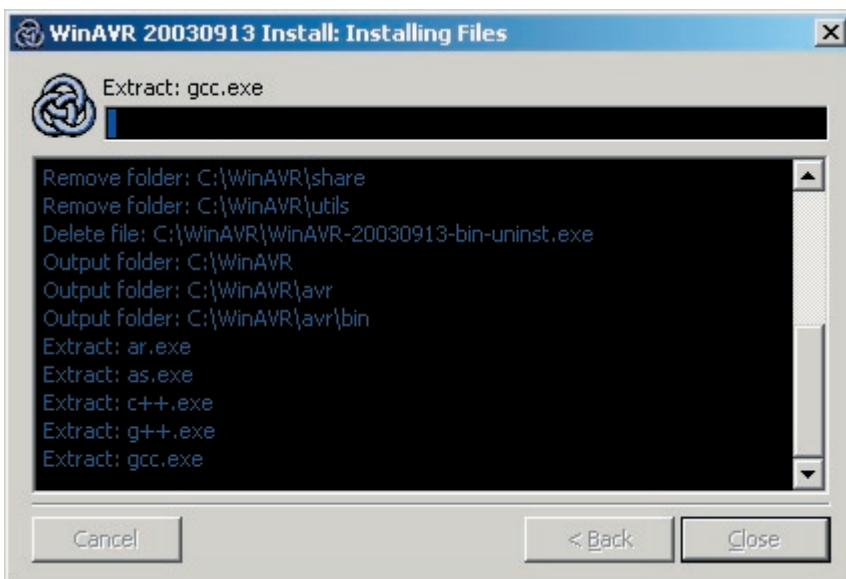

Wait...

Software

...till the programmers Notepad 2 (PN2) editor with the README.txt screen appears.

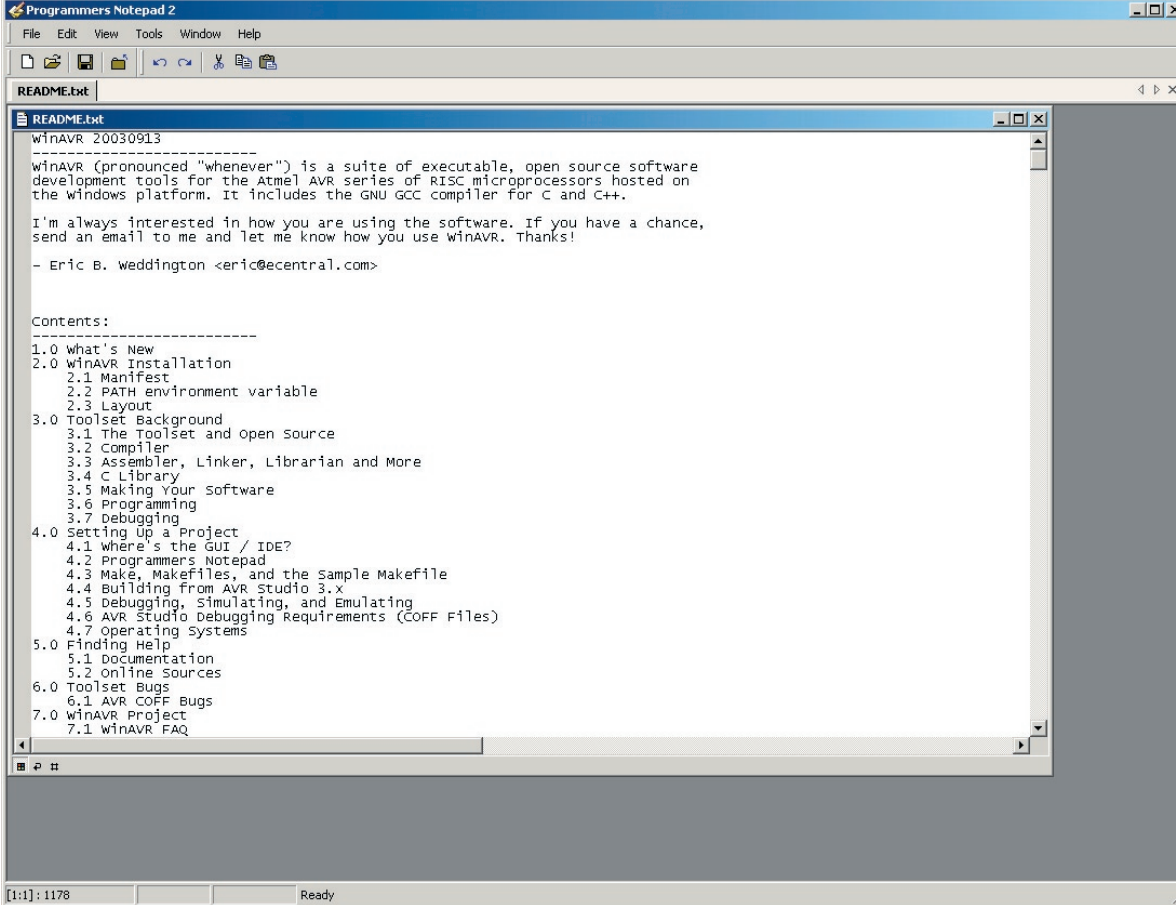

The screenshot shows a window titled "Programmers Notepad 2" with a menu bar (File, Edit, View, Tools, Window, Help) and a toolbar. The main text area displays the content of a file named "README.txt". The text includes the version "winAVR 20030913", a description of winAVR as open source software for AVR microprocessors, contact information for Eric B. Weddington, and a detailed table of contents.

```
winAVR 20030913
-----
winAVR (pronounced "whenever") is a suite of executable, open source software
development tools for the Atmel AVR series of RISC microprocessors hosted on
the windows platform. It includes the GNU GCC compiler for C and C++.

I'm always interested in how you are using the software. If you have a chance,
send an email to me and let me know how you use winAVR. Thanks!

- Eric B. Weddington <eric@central.com>

Contents:
-----
1.0 What's New
2.0 winAVR Installation
  2.1 Manifest
  2.2 PATH environment variable
  2.3 Layout
3.0 Toolset Background
  3.1 The Toolset and open source
  3.2 Compiler
  3.3 Assembler, Linker, Librarian and More
  3.4 C Library
  3.5 Making Your software
  3.6 Programming
  3.7 Debugging
4.0 Setting Up a Project
  4.1 Where's the GUI / IDE?
  4.2 Programmers Notepad
  4.3 Make, Makefiles, and the sample Makefile
  4.4 Building from AVR Studio 3.x
  4.5 Debugging, simulating, and Emulating
  4.6 AVR Studio Debugging Requirements (COFF Files)
  4.7 Operating Systems
5.0 Finding Help
  5.1 Documentation
  5.2 Online sources
6.0 Toolset Bugs
  6.1 AVR COFF Bugs
7.0 winAVR Project
  7.1 winAVR FAQ
```

Close the screen 'programmers notepad 2'.

On the DESKTOP the 'programmers notepad 2' Symbol appears:

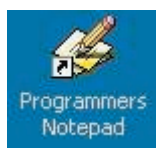

The program editor and the compiler are installed now.

8.1.3. Copying the example programs from CD to the harddisk.

Copy the folder 'ASURO_src' from the ASURO CD to the hard disk (put it in a folder something like this: 'C:\ASURO_src').

When the data source is secured, click with the right mouse button on the file, go to properties and deactivate the security.

Setup a menu input for the compiler in the program editor.

Open programmers Notepad 2' (click twice on the notepad symbol on your desktop):

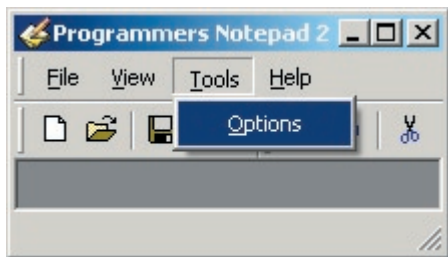

In menu Tools | Choose options.

The options-screen appears.

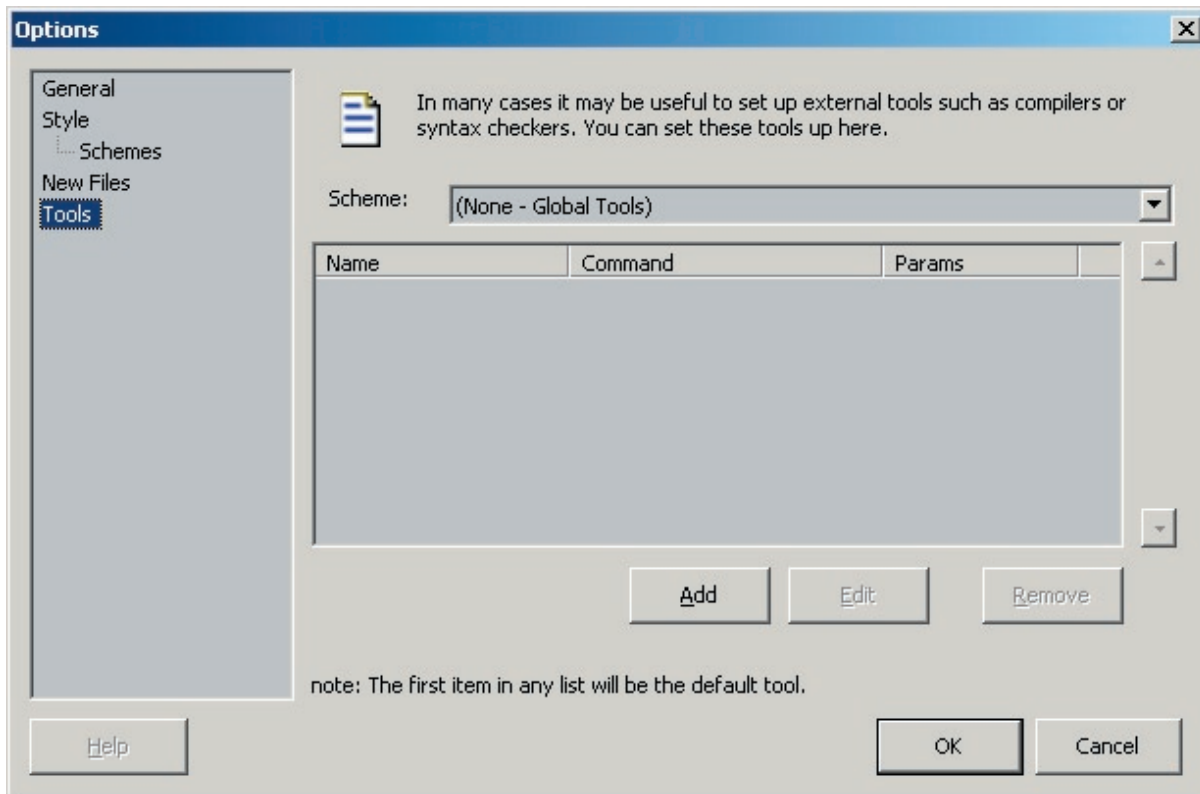

Select Tools.

Software

Select on the right side 'C/C++'.

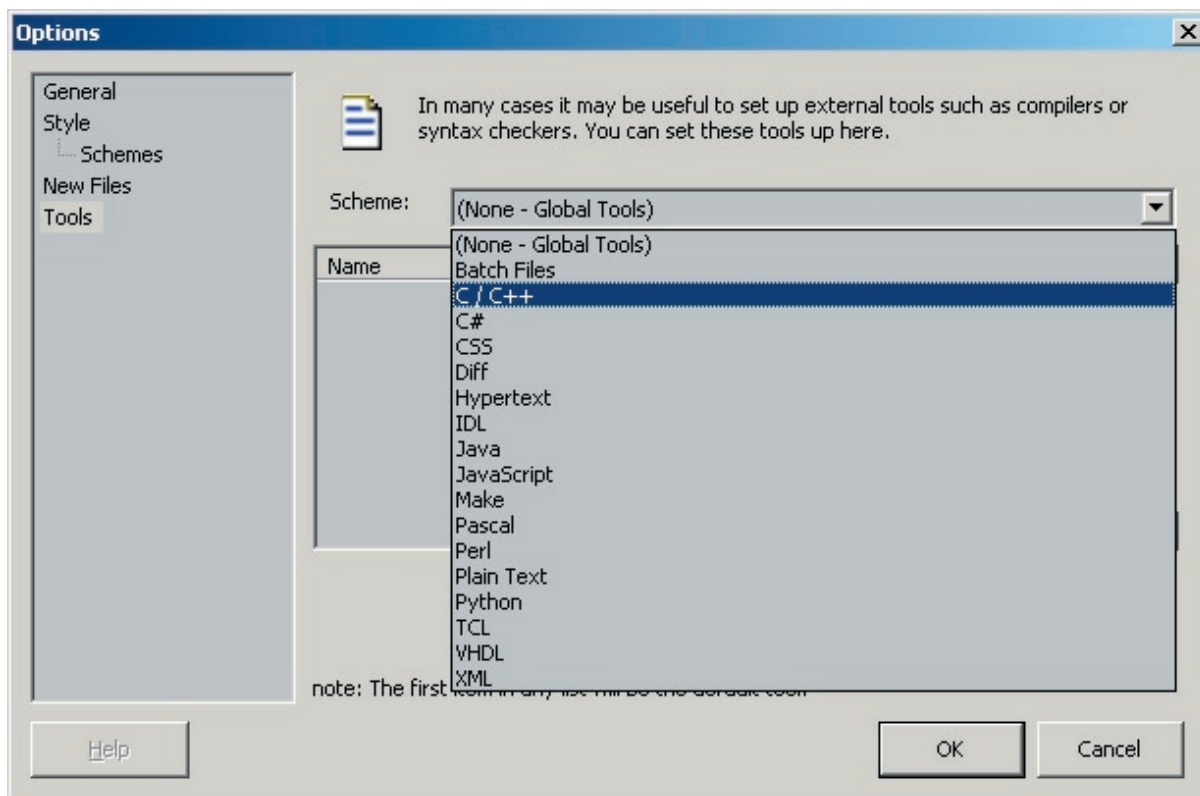

'C/C++' is selected.

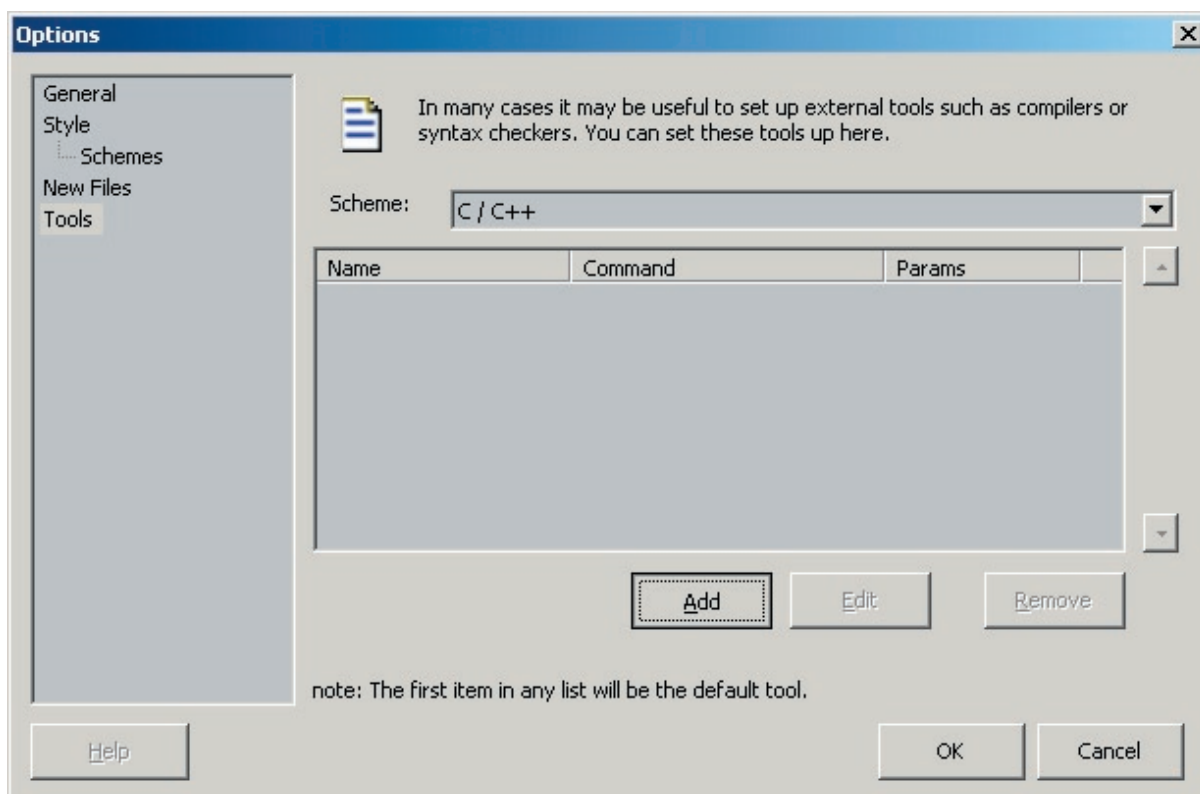

Click [Add] (...to insert a new tool)

Software

The window 'New Tool' appears.

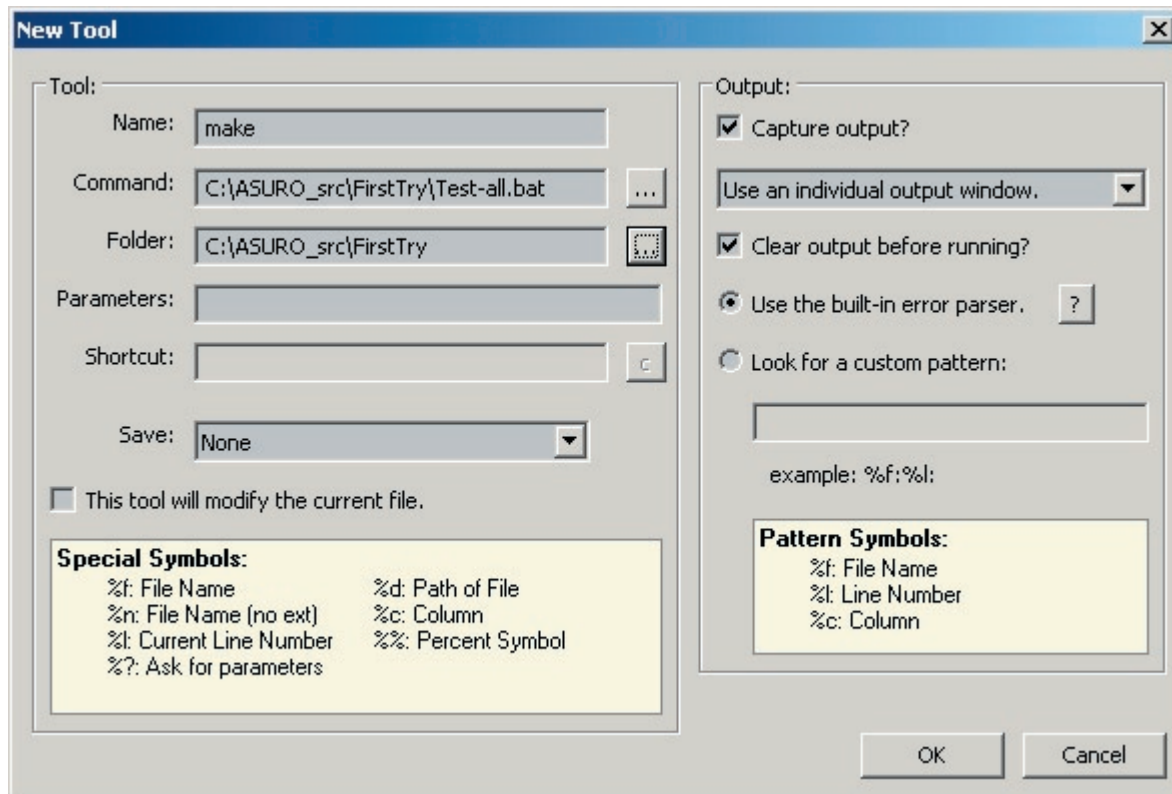

Type the following or select it with the Browse-button :

Name: make
Command: C:\ASURO_src\FirstTry\Test-all.bat
Folder: C:\ASURO_src\FirstTry

Click [OK]

A new PN2-tool with the name "make" is now available in the tools main menu.

(When we activate this tool, it will run a batch file with the name Test-all.bat, now the compiled data will be placed in the folder C:\ASURO_src\FirstTry).

Software

Setup a clean file In the program editor menu.

In the main menu “Tools” again “Options” and then select the “C/C++” again:

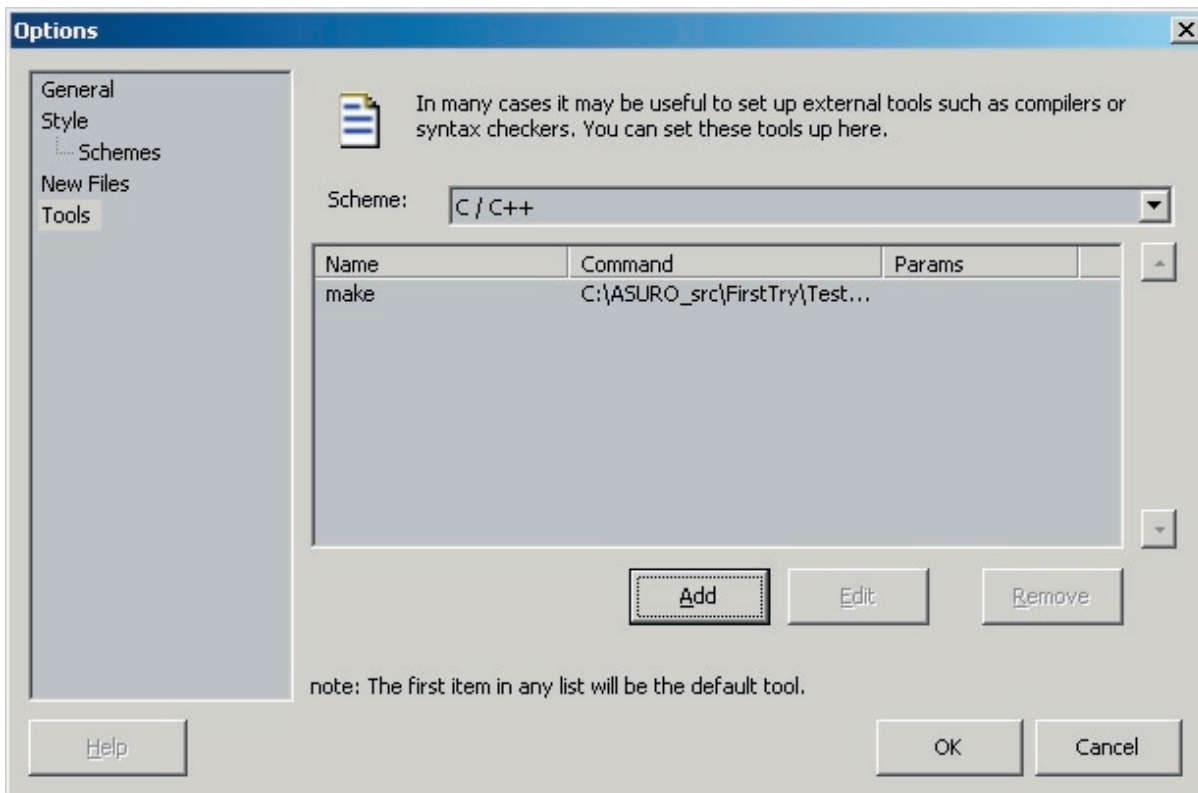

Click [Add] to add a new tool:

Software

The window 'New Tool' appears;

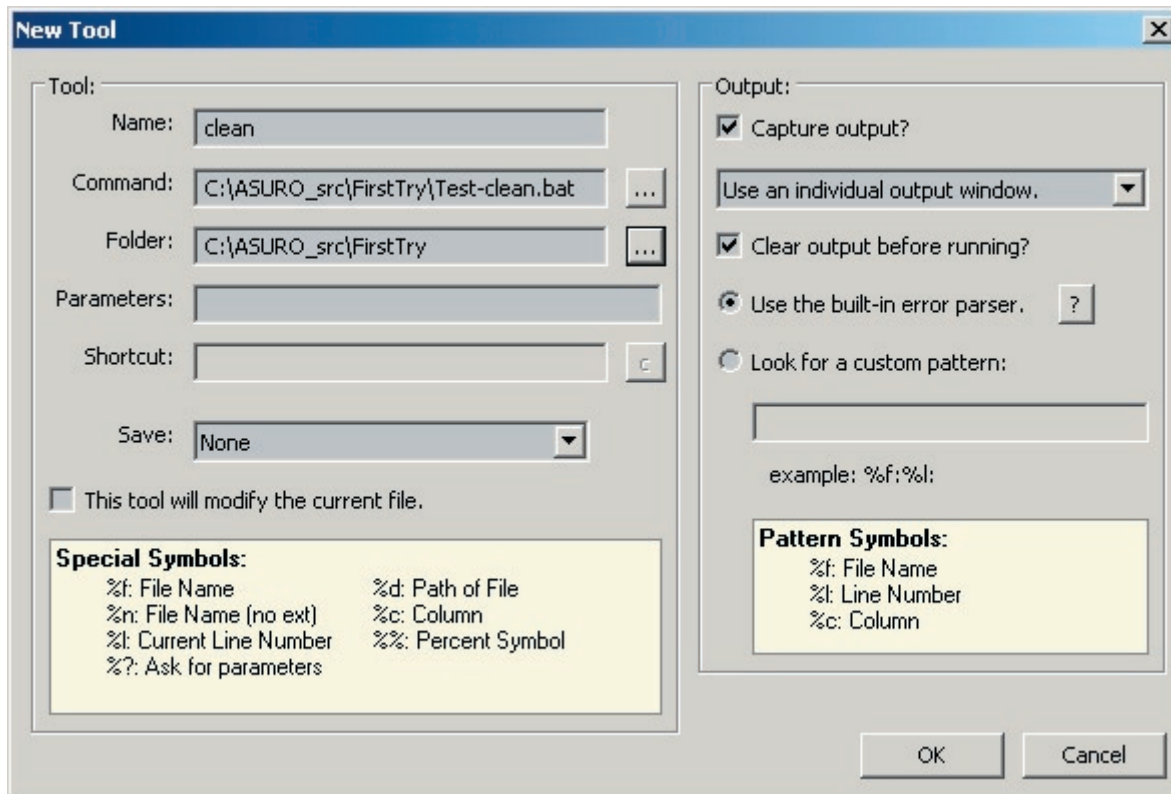

Type the following or select it with the Browse-button  :

Name: clean
Command: C:\ASURO_src\FirstTry\Test-clean.bat
Folder: C:\ASURO_src\FirstTry

Click [OK]

A new PN2-tool with the name "clean" is now available in the tools main menu.
(When we activate this tool, it will run a batch file with the name Test-clean.bat, now the compiled data which was placed in the folder C:\ASURO_src\FirstTry) will be removed.

Software

In the options-screen, under tools, you will now find the make and clean files which we have made in the previous steps.

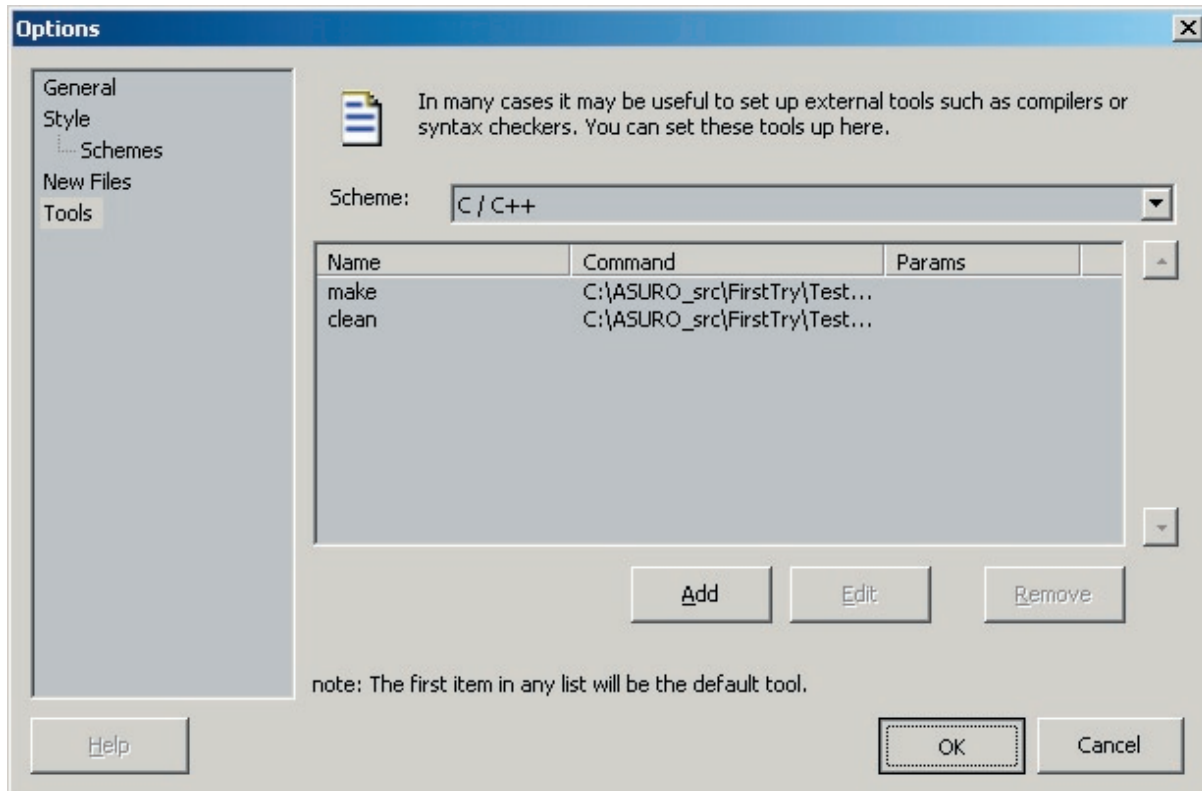

Click [OK]

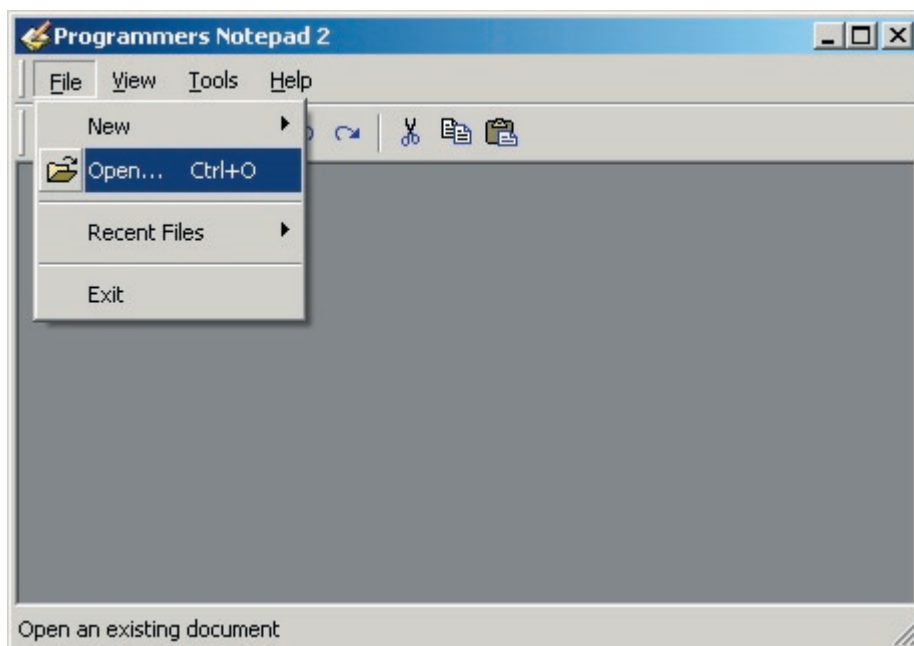

Software

Just for try we will open the file 'C:\ASURO_src\FirstTry\test.c' :

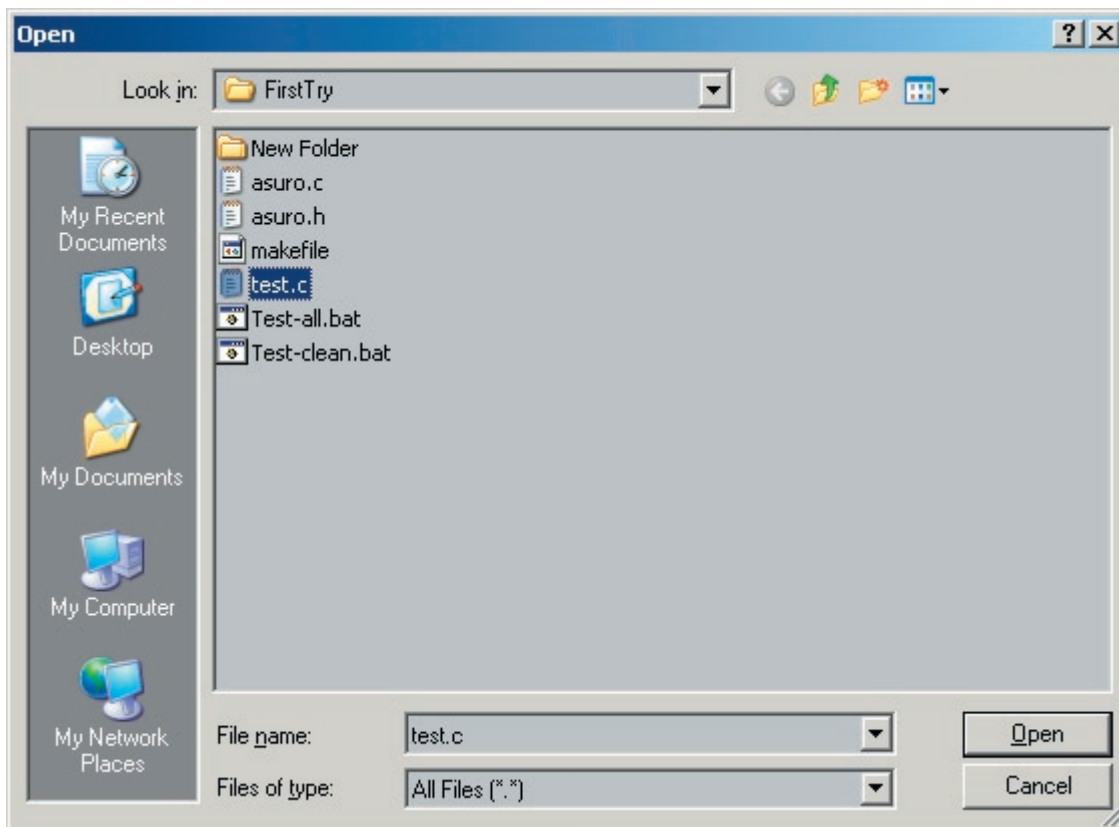

Click [Open].

Software

File test.c will be opened.

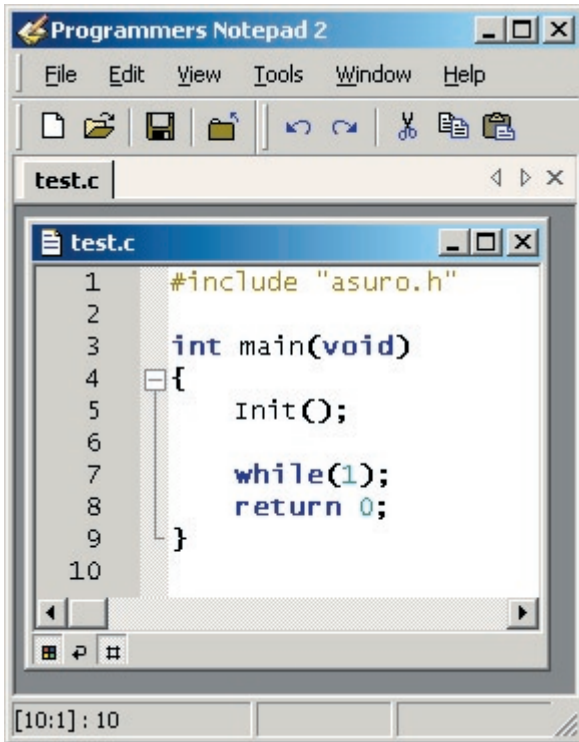

The screenshot shows the Programmers Notepad 2 application window. The menu bar includes File, Edit, View, Tools, Window, and Help. The toolbar contains icons for file operations and editing. The active window is titled 'test.c' and displays the following C code:

```
1  #include "asuro.h"
2
3  int main(void)
4  {
5      Init();
6
7      while(1);
8      return 0;
9  }
10
```

The status bar at the bottom indicates the cursor position as [10:1] : 10.

When you choose tools...

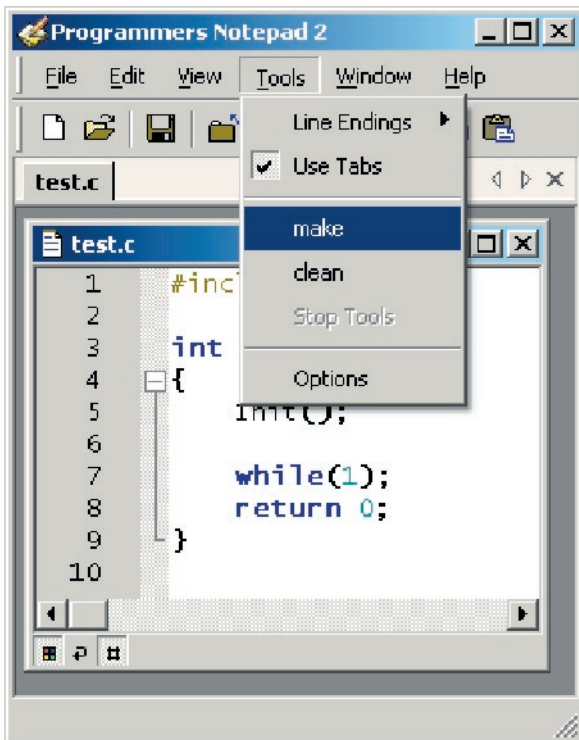

The screenshot shows the Programmers Notepad 2 application window with the 'Tools' menu open. The menu items are: Line Endings, Use Tabs (checked), make, clean, Stop Tools, and Options. The code in the background is the same as in the previous screenshot:

```
1  #include "asuro.h"
2
3  int main(void)
4  {
5      Init();
6
7      while(1);
8      return 0;
9  }
10
```

...you will find the new tools make and clean in the menu bar.

Click on make.

Software

The file test.c (together with asuro.c) will be compiled now...

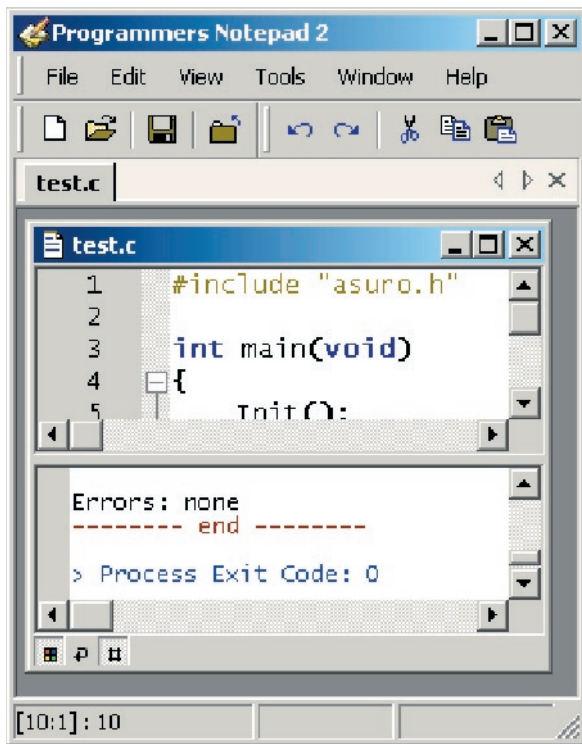

...and when the program does not contains any mistakes (what could be expected, because we just loaded an example program), on the bottom this message will appear: Errors: none.

What happened?

From the file test.c (and asuro.c) a new file test.hex was generated. This file contains the in machine code converted program. This machine code program can be loaded (flashed) in ASURO's memory. This program does not have a function. Later on, for trial, we will upload it in the ASURO memory with the Flash tool.

How did it work?

The menu input file calls the batch file Test-all.bat (this batch file contains a list with command lines which are executed line after line).

In Test-all.bat the command 'make all' will be executed. 'make' will create a make file which will be located (when we program ASURO) in the same file as Test-all.bat .

A make file is a text file, which defines how to compile one or more programs. During programming, when it is only one file, you still will have a good overview. Later, when a complex system is written and the programming data contains more files, which all must be converted in the correct way step by step and also connected (linked) with each other in a proper way, then also the make file will be very complex.

The "all" calls for all the input in the make file means, that a complete project and not only the separate inputs will be converted.

Software

The make file in our example program is written in a way that a file with the name test.c will be compiled together with asuro.c (which contains some pre defined functions) and create a new .hex-file. This file can be loaded (flashed) into the ASURO memory.

Attention! This means that - as long you do not change the make file and you only copy it - you should always name your own program test.c .

When you want to know all about make files (This is not absolutely necessary for operating the ASURO) you can find more background information at <http://www.gnu.org/directory/make.html>

The basics about ASURO-programming will be explained in chapter 9.

When you compile a program, some extra data is generated. This data is only necessary during the conversion, after that they are useless. These data files can be removed with the clean tool which we just created.

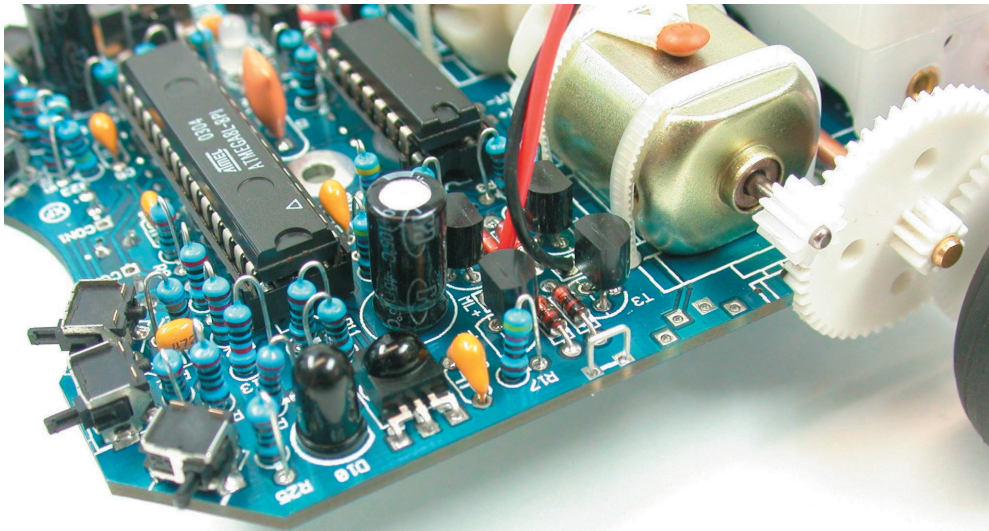

Software

When you open it....

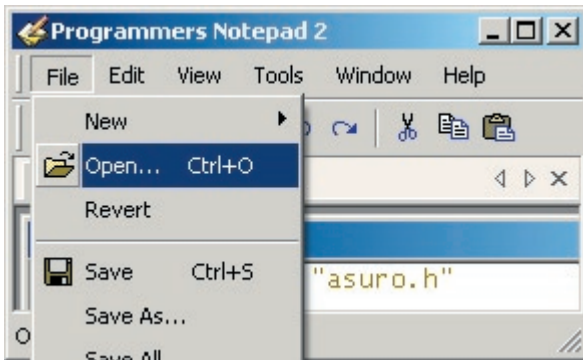

...you will see all the generated data files...

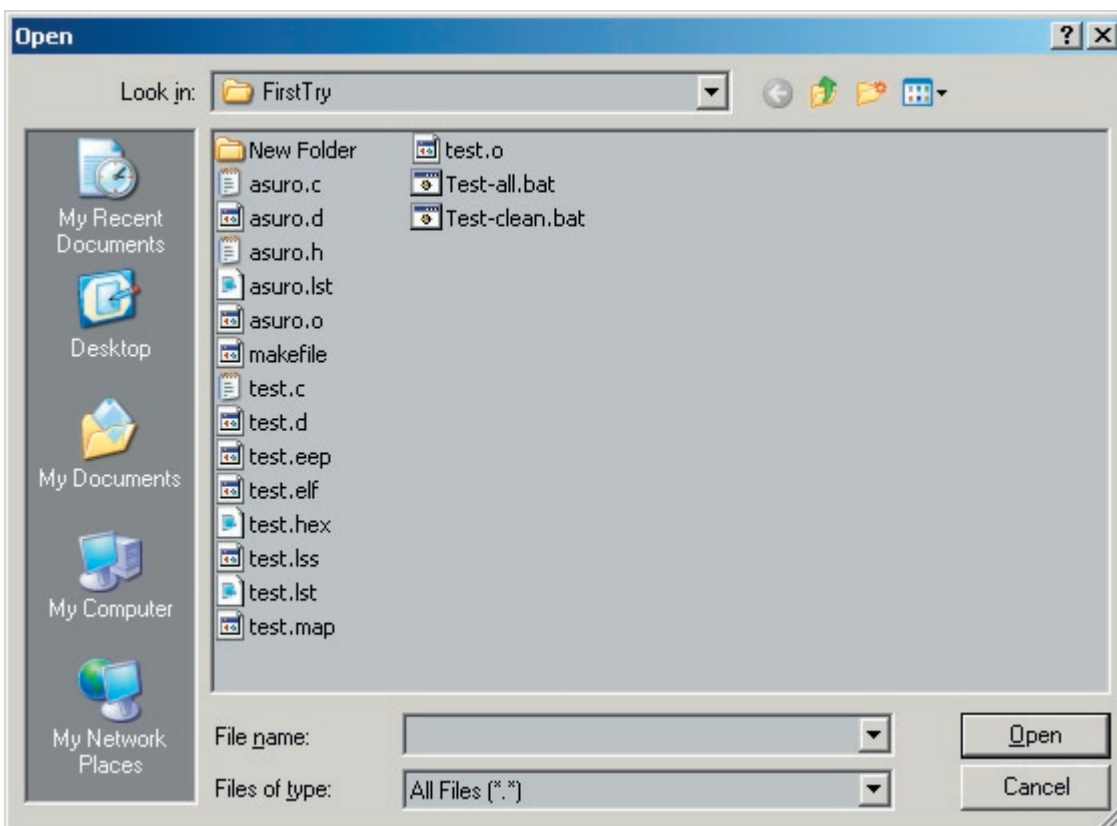

(Click [Cancel])

...and after you run the "clean" command.....

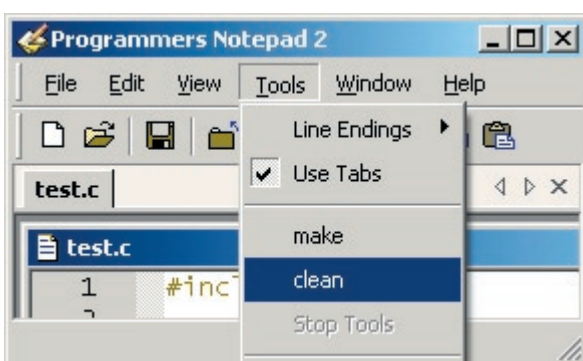

Software

...you will see...

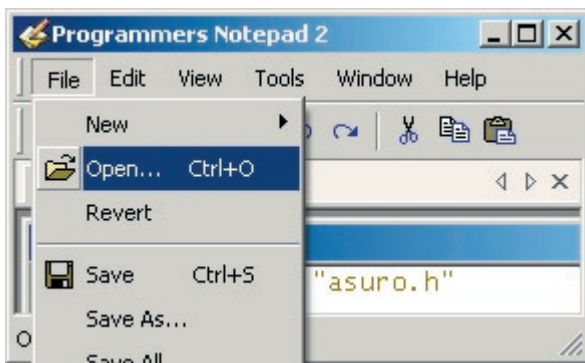

...that a lot of the generated data files are removed.

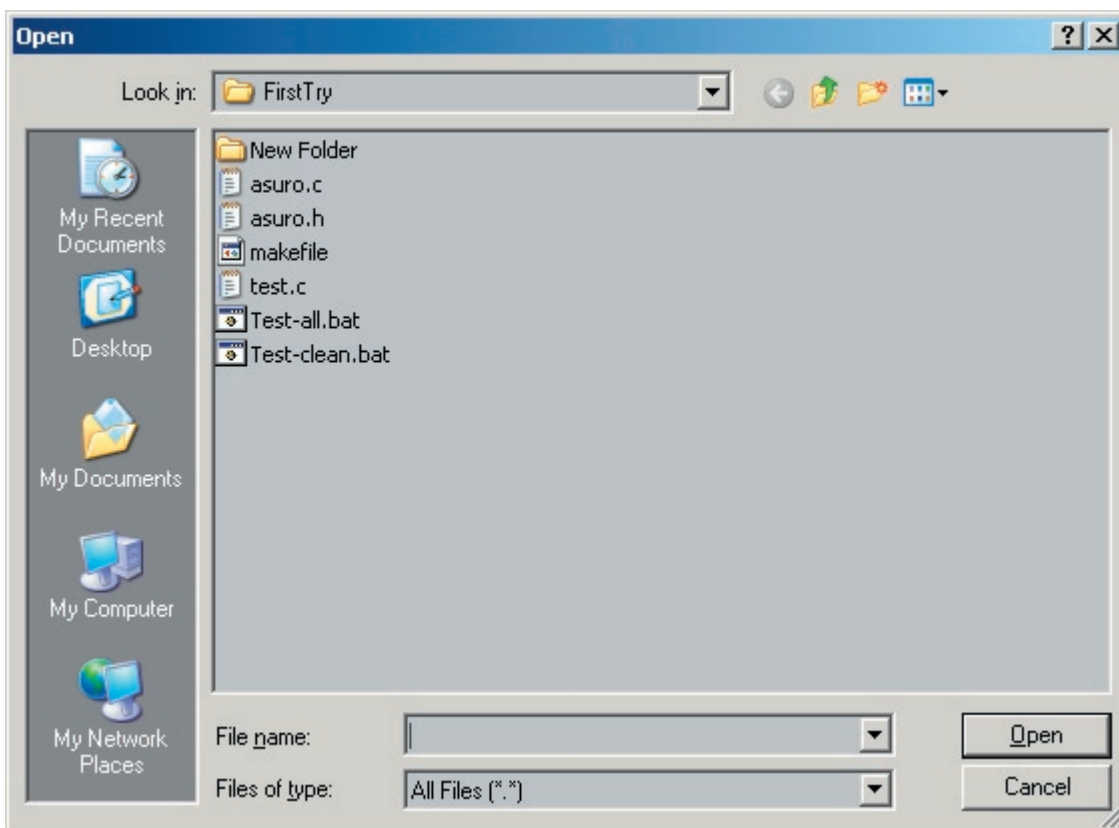

What did happen?

The menu input “clean” calls for the batch file Test-clean.bat. Make started this with the parameter “clean”. Now the input in the make file is executed in the name of clean and all data files which are not necessary anymore will be removed.

8.2. LINUX

For the software installation you need root rights. If you do not have this log out and log in again as root or open a shell and demand the root with 'su'.

8.2.1 Flash - The ASURO-programming-tool



Start the program from the CD software menu and copy the two flash tools "asuroflash" and "asurocon" from the folder "/linux/tools" into the folder "usr/local/bin". After this, you must allow the execution of the program with "chmod a+x/usr/local/bin asurocon and asuroflash."

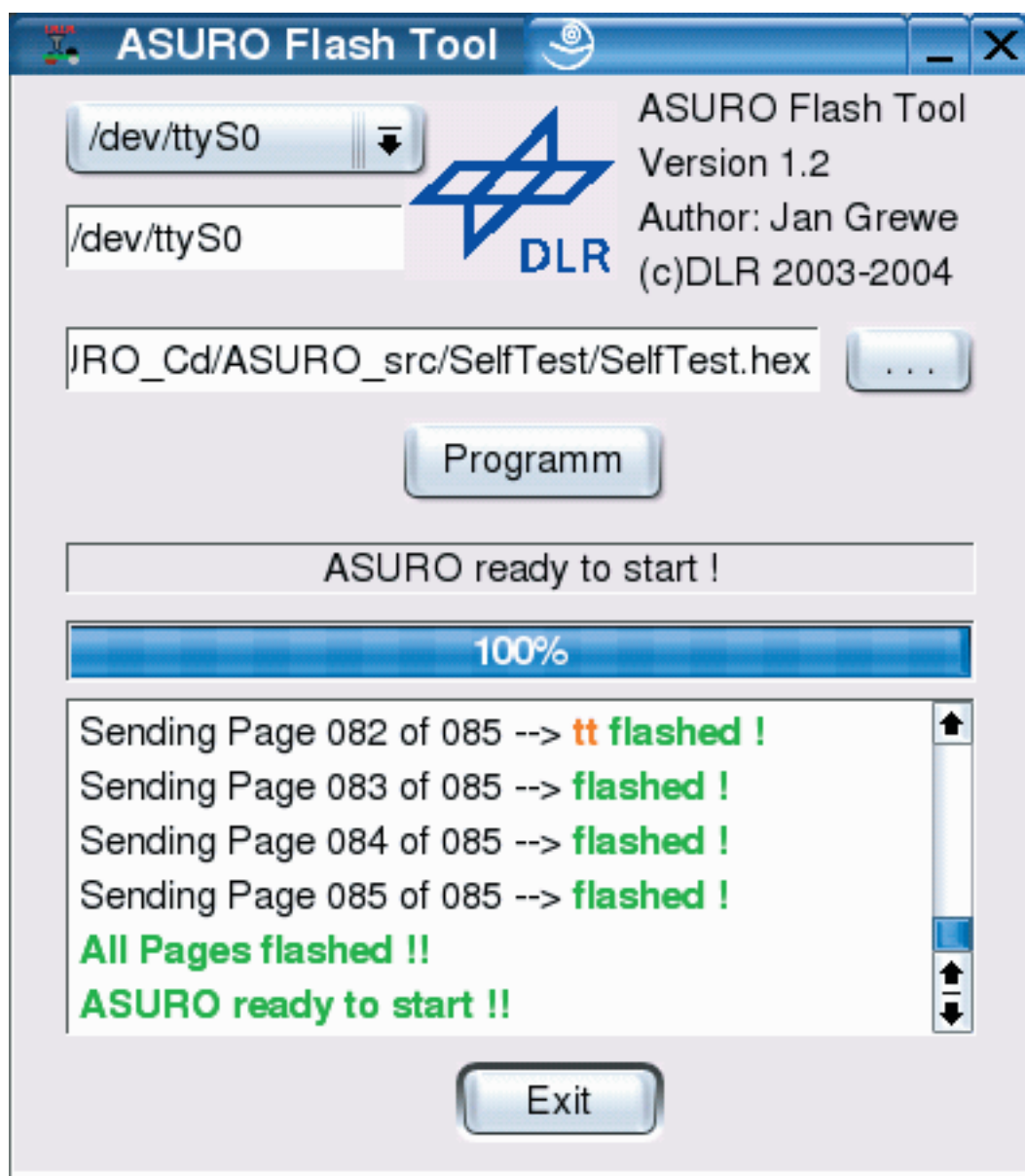

Fig. 8.1.: Flash-Tool

8.2.2 Compiler

To instal the Gnu-Compilers for AVR-Processors insert the ASURO-CDROM choose from the folder “/Linux/Compiler/” the folowing:

1. **avr-binutils-... .rpm**
2. **avr-gcc-... .rpm**
3. **avr-libc-... .rpm**

The Installation is quite simple!

Just give the command: `rpm -i <paket>.rpm` in your root directory.

Ready!

For Editors you can use Exmacs, Kate or Kedit. For trial you can copy the demo programs from the CD. You can find this in the folder “/ASURO_src/FirstTry/”

Then you can open a Shell, change the folder and enter “make”. when all is OK you will see the folowing window; (see fig. 8.2)

```

Befehlsfenster - Konsole
Sitzung Bearbeiten Ansicht Einstellungen Hilfe

grewe@linux:~/FirstTry> make all
set -e; avr-gcc -MM -mmcu=atmega8 -I, -g -O3 -funsigned-char -funsigned-bitfield
s -fpack-struct -fshort-enums -Wall -Wstrict-prototypes -Wa,-ahlms=asuro.lst asu
ro.c \
| sed 's,\(.*\)\.o[ :]*, \1.o \1.d : ,g' > asuro.d; \
[ -s asuro.d ] || rm -f asuro.d
set -e; avr-gcc -MM -mmcu=atmega8 -I, -g -O3 -funsigned-char -funsigned-bitfield
s -fpack-struct -fshort-enums -Wall -Wstrict-prototypes -Wa,-ahlms=test.lst test
.c \
| sed 's,\(.*\)\.o[ :]*, \1.o \1.d : ,g' > test.d; \
[ -s test.d ] || rm -f test.d
----- begin -----
avr-gcc --version
avr-gcc (GCC) 3.3 20030512 (prerelease)
Copyright (C) 2003 Free Software Foundation, Inc.
This is free software; see the source for copying conditions. There is NO
warranty; not even for MERCHANTABILITY or FITNESS FOR A PARTICULAR PURPOSE.

avr-gcc -c -mmcu=atmega8 -I, -g -O3 -funsigned-char -funsigned-bitfields -fpack-
struct -fshort-enums -Wall -Wstrict-prototypes -Wa,-ahlms=test.lst test.c -o tes
t.o
avr-gcc -c -mmcu=atmega8 -I, -g -O3 -funsigned-char -funsigned-bitfields -fpack-
struct -fshort-enums -Wall -Wstrict-prototypes -Wa,-ahlms=asuro.lst asuro.c -o a
suro.o
avr-gcc -mmcu=atmega8 -I, -g -O3 -funsigned-char -funsigned-bitfields -fpack-str
uct -fshort-enums -Wall -Wstrict-prototypes -Wa,-ahlms=test.o test.o asuro.o -
-output test.elf -Wl,-Map=test.map,--cref -lm
avr-objcopy -O ihex -R .eeprom test.elf test.hex
avr-objcopy -j .eeprom --set-section-flags=.eeprom="alloc,load" \
--change-section-lma .eeprom=0 -O ihex test.elf test.eep
avr-objdump -h -S test.elf > test.lss
Size after:
test.elf :
section      size      addr
.text        1422      0
.data         0      8388704
.bss          0      8388704
.noinit       0      8388704
.eeprom       0      8454144
.stab        8364      0
.stabstr     2311      0
Total       12097

Errors: none
----- end -----
grewe@linux:~/FirstTry> █

```

fig. 8.2.: Make all

8.3. Flash - The ASURO-programming-tool

In this step we will need the Flash-Program (see fig. 8.3).

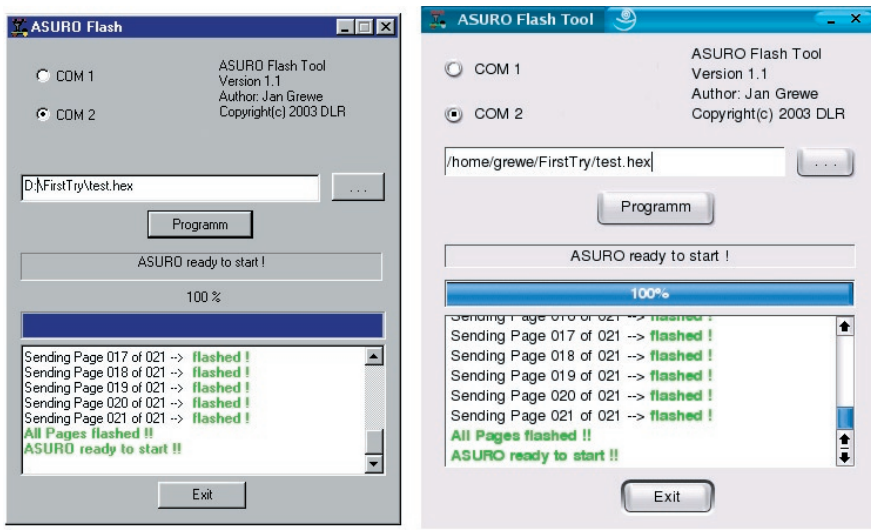

**Fig. 8.3.: Flash-Tools
for Windows and LINUX)**

Start the program and select the interface in which you have plugged the IR-Transceiver. Select Test.hex from directory C:\Own files\ASURO_src\FirstTry.

Place the completely assembled and tested ASURO near the IR-Transceiver, at a distance of max. 50 cm. The component sides of both PCBs must be facing and “seeing” each other. Click the button Programm at the Flash-Tool. Now switch S1 to ON-position, before the status-indicator reaches the right end of the status-area. If you have failed to react fast enough or communication has been disturbed, just switch ASURO off , press Programm and switch S1 to ON-position again.

As soon as communication is succesful, you may observe how the file Test.hex is being transferred to ASURO in the status-indicator and display. The program file will be stored in the Flash-memory inside the processor, where the program remains available even after switching off the supply voltage.

After loading the program, ASURO will have to be switched OFF and ON again in order to start the program. This sequence will execute the loaded program and the green LED will be lit up brightly.

8.3.1. What is happening while flashing?

As soon as the Flash-program has been executed, the PC will be try to communicate with ASURO. By switching on ASURO, the system will be booted, indicated by the Status-LED bi-colored lighting for one second. ASURO is checking to see, if new software has been prepared to be loaded. If a new program has been found, it will be loaded. After loading, the program will be executed by switching OFF and ON once again.

8.4. Flash failures

The following errors may occur while flashing:

- “C” Checksum Error. ASURO has received some irregular signals. Signals may have been disturbed by other optical sources, such as fluorescent lights, or have been interrupted shortly by movements.
- “t” Timeout. The line-of-sight between ASURO and the IR-Transceiver has been interrupted completely.
- “V” Verify Error. ASURO wrote invalid data into its Flash-memory. This is a most unusual situation, indicating the non-volatile programming memory (Flash-EPROM) has reached the end of its lifetime, according to specifications after approximately 10.000 programming cycles.

Error correction can be retried ten times. In case of failure the flash-procedure will be aborted.



If Checksum Errors are being indicated regularly while Flashing, you may switch off or dim some lights in the room, especially fluorescent lights. Remember:



*Always press the Program-button, before switching ON the ASURO.
Otherwise the download procedure will not be started.*

8.5 Your first program

In the programmers Notepad the loaded sourcefile will be modified. Attention please: follow exactly the text in the example, including upper case and lower case.

```
#include "asuro.h"
int main(void) {
Init();
StatusLED(RED);
while(1);
return 0;
}
```

Store the file and choose the menu Tools -> make, observing the messages in the display window. Wait a few seconds until the program finishes the report. Check the status window for a bottom line Process Exit Code: 0, indicating the source has been processed correctly by the compiler.

Software

If the compiler displays another message, you will have to trace the error by analysing the source code. It is a good idea to look at the first line in the source, in which errors have been reported. The editor displays the line number in the source in the left bottom corner of the display window.

After a successful translation you may deliberately alter a word in the program source. Restart the make procedure and check, in which line number the “error” has been reported.

Following an error free compilation, the new program may be flashed. Connect the IR-Transceiver, start the Flash-Tool, select the newly created program test.hex and the correct COM-interface. Place ASURO near the IR-Transceiver, activate the Programm button and wait until the transfer of the file has been completed.

After the statusline in the display has reported a successful completion of the file transfer, switch OFF ASURO and switch ON again. Wait a second and check the status-LED switching to red. Before altering the source code, some more programming background should be available. It is advised to read the following chapter first.

NOTE!

It is also possible to load the demo program test.c from the Folder ASURO_src\FirstTry;

This program contains the lines below;

```
#include "asuro.h"
int main(void) {
  Init();
  while(1);
  return 0;
}
```

It can be easily changed into the program on page 54.

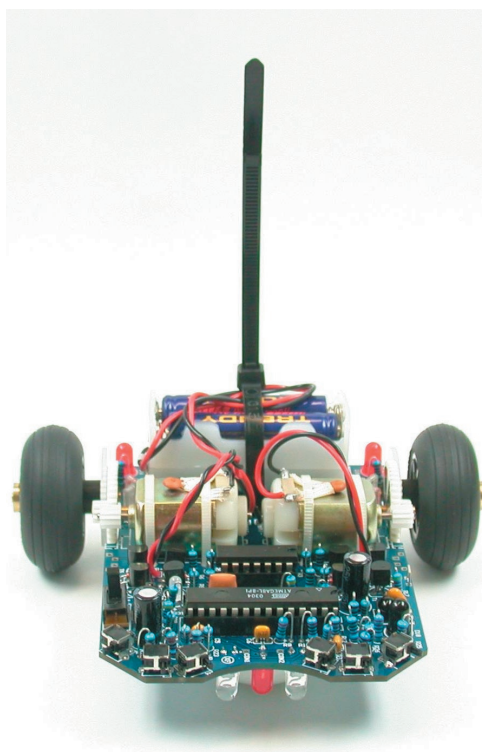

9. C for ASURO

This chapter is devoted to the programming language C, but explanation will be limited to the elements which are needed to control the ASURO system. Obviously the explanation is not a complete C-manual, for which other literature may be found on the market¹.

C has been chosen for its widespread standard and because a C-Compiler is available for almost every processor. For ASURO we selected the Gnu-C-Compiler, a freeware program, which generates a well optimized code for ASUROs ATmega8 processor.

Whoever is familiar with C will not read anything new in this part of the manual and may proceed reading chapter 9.2. We will describe selected elements, absolutely necessary for the ASURO control.

Don't worry: If you take care to use brackets and semicolons, the language C is not too difficult at all. And of course the ASURO is not a toy!

9.1. Basics in C-Programming

9.1.1. Introduction

Basically the processor executes commands in a C-program step by step from the beginning to the end of the program². Parallel processing cannot be provided in ASUROs standard processor, so we will have to think in sequential working commands.

Empty spaces at the beginning of lines in examples, are simply structural reading aids and may be left out. Inset spaces however provide excellent programming structure and are extremely helpful keeping an overview in extended programs.

In C each command has to be completed with a semicolon “;”, enabling the compiler to assign all elements to the correct command. If commands are to be joined in functions, loops or conditional statements, this set of commands will be grouped by placing it inside a pair of special brackets (“{”, “}”).

Example:

```
#include "asuro.h"
int main(void) {
/* All elements between these brackets belong to one set of commands */
}
```

¹For Example: Brian W. Kernighan, Dennis M. Ritchie: “Programming in C”,

²Methods to deviate from sequential control in programs are being named „flow control“ and will be described in a later chapter.

If we want to place a comment between programming lines, the set of comment words or lines starts with “/*” and ends with “*/”. A single line may also be defined to be a comment by starting the line with “//”³. Transforming programming lines into comments is often used to exclude parts of the program from being processed. The compiler will ignore all comments. Correctly inserted comments will never cause problems in program execution.

9.1.2. Variables and Datatypes

In programming, variables are being used as container elements for data and they may be defined, filled, read or changed in the course of the program. In order to use a variable, it has to be declared at first. In declarations, variables will be assigned to types and they also may be provided with an initial value. Types define which kind of data are to be stored inside the variable (integer numbers, positive integers, real numbers, etc....).

Variables are referenced by names, which have to begin with a letter (underscore “_” will be counted as a letter as well) and may also contain numbers, but none of the other special characters. Capital letters and noncapital letters will be discerned. As an example: x and X reference to different variables. Normally capital letters are being used for constants (which cannot be changed in program flow, e.g. the number PI = 3.1415) and small letters are being used for variables.

The following names are reserved words and cannot be used as names for variables:

<i>auto</i>	<i>default</i>	<i>float</i>	<i>long</i>	<i>sizeof</i>	<i>union</i>
<i>break</i>	<i>do</i>	<i>for</i>	<i>register</i>	<i>static</i>	<i>unsigned</i>
<i>case</i>	<i>double</i>	<i>goto</i>	<i>return</i>	<i>struct</i>	<i>void</i>
<i>char</i>	<i>else</i>	<i>if</i>	<i>short</i>	<i>switch</i>	<i>volatile</i>
<i>const</i>	<i>enum</i>	<i>int</i>	<i>signed</i>	<i>typedef</i>	<i>while</i>
<i>continue</i>	<i>extern</i>				

The following data types will be used for ASURO programming:

Type	Range of values	Remarks
char	-128 ... +127	a (8 bit long) byte, may store a character from the alphabet
unsigned char	0 ... 255	unsigned characters, may store positive values only.
int	-32768 .. +32767	two byte values in the range -32768 .. +32767
unsigned int	0 ... 65535	positive integers in the range 0 ... 65535
float		real numbers

³ According to C++ Standards “//” is a comment mark. In fact the compiler for ASURO is a C++-Compiler and will understand “//” as a comment mark. “//” as a comment mark may however cause problems in other compilers.

Declaration of variables may be provided as global variable outside the main()-function or as a local variable inside the main()-function. Global variables will be valid in the complete program area. Local variables will be valid inside the main()-function or any other function only. They will be valid for the programming code inside the function and they will be invalid outside the function.

Variables are rather useless, as long as we are unable to fill them with data. Assigning data is however rather easy:

```
a=17; // variable a contains a value 17
```

or alternatively in a calculation:

```
a=17+23;           // variable a contains a value 40
Speed=a+3;         // variable Speed contains a value 43
Speed=Speed*2;    // variable Speed contains a value 86
```

It is good programming practice to use clear understandable names. The variable name "speed" in this example is self-explainable. Using simple letters as a variable should be restricted as it often results in "unreadable" programming code.

The following example may demonstrate a simple, complete programming source:

```
#include "asuro.h"
int main(void) {
int i;           // i may contain numbers between -32768 and 32767
char any_token; // variable any_token may contain ASCII-symbols or
                // numbers between -128 and 127

i=3;
any_token =17+i; // any_token will now be assigned 20
i=i/2;          // Division by 2, will always be rounded down
                // therefore i will now be assigned 1!

return 0;
}
```

A few interesting shortcuts are useful in the programming language C, e.g.:

```
i=i+1;
```

may also be written as:

```
i++;
```

Equally:

```
i=i-1;
```

may be written as:

```
i--;
```

9.1.3. Compiler directives

You may have wondered about the first program line `#include "asuro.h"`. This `#include`-directive defines an inclusion of an external source code into your program and orders the compiler to include the textfile in the compiler sequence. Our include-file contains some functions, which will be needed for robot operations.

Another important directive (amongst others, which are lying beyond the scope of our introduction to C) is the so called text replacement. This directive will be defined by a pattern:

```
#define NAME replacement_text
```

and will be used to define constants in our programs.

Wherever the symbol NAME is found in the source text, it will be replaced automatically by `replacement_text`. For the NAME following `#define` the same naming conventions as for variables have to be applied. C-programmers are used to writing the symbols (eg. NAME) at the `#define` in capital letters.

Example:

```
#include "asuro.h"
#define STARTINGVALUE 33
int main(void) {
int i;
i= STARTINGVALUE; // the value for i is now 33
return 0;
}
```

Remark: Compiler directives are not closed by a semicolon!

9.1.4. Conditions

Sometimes we would like to execute commands under certain conditions. These conditional sequences are called control structures. The simplest of these control structures is an "if-else" sequence.

In "C" the correct syntax will be as follows:

```
if (Condition)
    Command_block_1
else
    Command_block_2
```

The program will check the value of the condition between the brackets. If the condition is true (which implies any value except zero), the program will execute `Command_block_1` and otherwise the optional `Command_block_2`.

If the program should be able to choose one option out of several alternatives, you may use several “else if”-constructs.

```

if (Condition1)
  Command_block_1
else if (Condition2)
  Command_block_2
else if (Condition3)
  Command_block_3
else if (Condition4)
  Command_block_4
else
  Command_block_5

```

The following conditional structures may be used:

Operator	Explanation
==	comparision for equal
!=	comparision for unequal
<	comparision for less
>	comparision for greater
<=	comparision for less or equal
>=	comparision for greater or equal

Example:

```

#include "asuro.h"
int main(void) {
  while (1) {
    if (PollSwitch(>0) {StatusLED(RED);}
    else {StatusLED(GREEN);}
  }
}

```

If one of the collision detector switches has been activated, the status-LED will be switched on red, otherwise in green. The other programming code will be explained later.

In the C-language a value “1” represents true and “0” represents false.

The conditional statement:

```

if (0) {StatusLED(RED);}

```

of course implies the command StatusLED(RED) will never be executed.

9.1.5. Loops

Loops are to be used to repeat command execution.

In a “while”-loop a condition is checked every time the loop is passed. If the condition is true the command block will be executed. The condition is checked again until it turns to false. At a false condition the program is continued at the first command following the condition block.

```
while( Condition)
  Command block
```

Example:

```
#include "asuro.h"
int main(void) {
    MotorDir(FWD,FWD); // Both engines running forward
    MotorSpeed(120,120); // Both engines running at around half speed
    StatusLED(GREEN); // Turn on Status-LED green
    while (PollSwitch()==0) { // As long as there is no collision
        SerWrite("All OK!\n",10); // ... Feeling groovy ....
    }
    MotorSpeed(0,0); // Collision! Stop immediatedly!
    StatusLED(RED); // Turn on Status-LED red
    while (1) {
        SerWrite("Ouch!\n",5); // start crying!
    }
}
```

A “for (expr1, epr2, expr3)”- sequence is equivalent to:

```
expr1;
while( expr2) {
    Command block
    expr3;
}
```

A “for”-sequence is often used as counter sequence.

```
for (i = 0; i < n; i++)
    . . .
```

Example:

```
#include "asuro.h"
int main(void) {
    int counter; // define a variable for counting
    for (counter =0;counter <10;counter ++) { // repeat ten times:
        SerWrite("Go ahead!\n",10); // "Go ahead" message
    }
    MotorDir(FWD,FWD); // Both engines forward
    MotorSpeed(120,120); // Both engines running at around half speed
    while (1) { // No more action!
    }
}
```

“while(1)” is equivalent to “for(;;)”, and both are eternal loops as the abort condition (in this case a value 0) will never be reached.

Another loop sequence is a “do”-loop

```
do
command block
while( condition);
```

In contrast to a “while”-loop the condition will be checked after the command block. This programming sequence forces the command block to be executed at least one time.

9.1.6. Functions

A definition block for a function always looks like:

```
Functions type Functions Name (ParameterType1 ParameterName1,
ParameterType2 ParameterName2, ...)
```

Really great, definition blocks for a function! Why so complicated???

Well, they are very useful, but their explanation is rather complex and may be postponed...

Sometimes we need to use the same programming sequences at different locations in our programs. Of course we might repeat the writing or use a copy/paste-method for this purpose (this is an annoying procedure and turns our program into a mess) or we just define a function.

Now sometimes we need to pass a few variables to a function, eg. telling our *GoAhead ()* -function to use a given speed exactly, a certain lapse of time or a defined distance. We will use parameters for these details.

Sometimes a function will even return a value. A good example is the *HowManySwitchesHaveBeenActivated ()* -Function, returning a value, which will be defined somehow and somewhere within the function-block. The value is returned by a *return*-command at the end of the function-body. That's why functions end with *return;* or *return number;*.

A special function is the *main ()* -function, defining the main body of a program. In ASURO the *main ()* -function will be executed at switching ON. Of course **every program must** be supplied with a *main ()* -function.

Now after some theory on data types and functions we would like to build a simple function, multiplying two 8-bit numbers and returning the result.

```
int Mult (char a, char b)
/* Function returns an int-value, is called Mult, and uses two char values for input */
{
    int c;           // Declaring variable c as an int
    c = a * b;      // calculate c
    return c;       // returning integer c
}                  // End of the function "Mult"
```

Now an example program, which will use the Mult-function we have defined before:

```
int main (void)           // Function main always returns an int and will not
                          // input any parameter
{
    char mult1,mult2;     // Defining two „char“-variables
    int result;           // Defining an int-variable for the result of multiplying
                          // variables mult1 und mult2
    mult1 = 2;            // assignment
    mult2 = 10;           // assignment
    result = Mult(mult1,mult2); // calling the previously defined function "Mult"
    return 0;
}                          // End of function „main“
```

9.1.7. Pointers and vectors

Pointers and vectors will be described to an extent, needed for the ASURO-operations.

If we need to track data from the line tracing sensors or odometric sensors we will need vectors. Their declaration is rather simple:

```
int lineData[2];
int odometrieData[2];
```

As you will recognize we will create two vectors (lData, oData) with 2 elements for linetracing and for odometrics. By calling ASURO Function (LineData(), OdometrieData ()) element [0] receives the value of the left sensor and element [1] receives the value of the right sensor.

We will demonstrate this method in an example:

If the right sensor receives more light than the left sensor, command1 should be executed otherwise command2.

```
int lData[2];           // Provide memory space for measurement results
LineData(lData);      // Reading measurement data
if (lData[1] > lData[0])
    command1;
else
    command2;
```

To use the serial interface functions (*SerWrite ()*, *SerRead ()*) we need character strings. These will be declared as follows:

```
char message[] = "This is a text string"
```

In order to send a text string in ASURO, a function *SerWrite()* is called with appropriate parameters. The first parameter contains the text string or the variable containing the text string, the second variable describes the number of characters to be sent, eg.:

```
SerWrite(message,20);
```

respectively

```
SerWrite(„This is a text“,14);
```

will transmit a message “This is a text” over the IR-Interface.

To receive characters, ASURO uses a function *SerRead ()*. The first parameter contains a variable in which the received characters are to be stored. The second parameter defines how many characters will be received and the third parameter defines a timeout: if within a certain time period (a number of processor clock cycles) no data has been received the *SerRead ()* -function will be aborted. By using a number "0" however, the function will wait until all characters have been received. An example will illustrate this function.

ASURO is to receive a message "Hi, here I am" by IR-interface. By a string definition

```
char message [] = "01234567890123456789"
```

we first allocate some storage space for the expected text. Of course the storage space must be big enough to contain the expected message.

```
SerRead (message,13,0)
```

Read 13 characters and wait until 13 characters have been received. We now consider the text string "Hi, here I am" has been sent. The function will now overwrite the first 13 characters of the predefined string message with "Hi, here I am", resulting in a string:

```
Hi, here I am 3456789
```

9.2. Overview of the ASURO-Functions

A few functions have been developed to support ASURO's programming. These functions are by no means optimal solutions and for some purposes it is a good idea to write special functions. All functions have been developed as defined in declarations and may be understood by inspecting the examples.

Just to avoid misinterpretations: controlling functions like motor-controls or display-functions change a status, which will remain valid until changed again. A green LED display will remain green until changed to another colour or switched off.

9.2.1. void Init(void)

This function will reset the microprocessor to its initial state and must always be executed at the beginning of a program. If the function is missing, the processor does not even know, what to do with its terminals. A simple ASURO program should at least look like:

```
#include "asuro.h"
int main(void) {           // here we declare some variables
    Init();                // here we insert our own function blocks
    while(1);              // eternal loop
    return 0;              // will never be executed
}
```

Why did we insert the eternal loop at the end of the *main ()* -function? Normally the *main ()* -function will be closed by *return 0;* marking the end of the program. In ASURO however some parts of old programs flashed earlier, may still remain in the memory and be executed, resulting in strange effects. To avoid abnormal execution of old program fractions we "catch" the program after execution in an eternal loop. This way we can be sure the program ends in a defined state.

9.2.2. void StatusLED (unsigned char color)

The Status-LED (D12) will be switched OFF or ON. Valid parameter values are OFF, GREEN, RED or YELLOW

Example:

The Status-LED will be switched ON in red by:

```
StatusLED (RED);
```

OK, OK, we will demonstrate a complete example program:

```
#include „asuro.h“
int main(void) {
    Init();
    StatusLED (YELLOW);
    while(1);           // eternal loop
    return 0;
}
```

9.2.3. void FrontLED (unsigned char status)

The Front-LED (D11) will be switched ON or OFF. Valid parameters are ON respectively OFF

Example:

The front-LED will be switched on by:

```
FrontLED(ON);
```

9.2.4. void BackLED (unsigned char left, unsigned char right)

The Back-LEDs (D15 and D16) will be switched ON or OFF. The first parameter describes the state of the left back-LED (D15) while the second parameter describes the state of the back-LED at the right side (D16). Valid parameters are ON respectively OFF

Example:

The back-LED at the right side (D16) will be switched ON and the back-LED at the left side (D15) will be switched OFF by:

```
BackLED(OFF,ON);
```

9.2.5. void Sleep (unsigned char time72kHz)

This function will command the processor to wait some time. The waiting period may be defined by a parameter (unsigned char)⁴., containing a number of maximal 255 and counting cycles from a 72kHz-timer.

Example:

The processor should sleep for ca. 3ms. ==> $\frac{0,003s}{\frac{1}{72KHz}} = 216$.

The function sleep (216); will force the processor to wait for 3ms.

```
Sleep (216) ;
```

9.2.6. void MotorDir (unsigned char left_dir, unsigned char right_dir)

This function controls the direction of both engines and should be called before calling speed controls. Valid parameters are FWD (Forward), RWD (Backward), BREAK (Brake or sudden stop, by short circuiting the motors in a transistor bridge) and FREE (Freewheeling).

Example:

The left motor should be moving forward, while the right motor is halted.

```
MotorDir(FWD,BREAK);
```

⁴ The authors have chosen this method deliberately, just to train the readers brains.

9.2.7. void MotorSpeed (unsigned char left_speed, unsigned char right_speed)

This function controls the motor speed for both engines. Maximum speed is 255 (unsigned char). The motor will start rotating at a value of around 60, depending on mechanical conditions. The parameter value in fact controls motor power and the rotational speed also depends on other factors like friction or inclination in slopes.



As soon as this function has been executed ASURO will start moving. Sometimes the program however results in unexpected movements and we must take care ASURO cannot do any harm to others or itself.

Example:

The left motor is to move at maximum speed, the right motor not at all. The direction of movement has previously been defined by *MotorDir ()*.

```
MotorSpeed (255,0);
```

9.2.8. void SerWrite (unsigned char *data, unsigned char length)

This function outputs data from ASURO by the serial IR-interface at 2400Bit/s, No-parity, 1 StopBit, NoFlowControl. The first parameter contains the reference to the data to be sent, while the second parameter describes the number of characters to be sent.

Example:

A string „Hello how are you?“ should be sent by IR-interface:

```
SerWrite (“Hello how are you?”,18);
```

9.2.9. void SerRead(unsigned char *data, unsigned char length, unsigned int timeout)

Once you are able to transmit data by IR-interface, you may probably also wish to receive some. The next function will allow you to do so. The first parameter is a pointer to the storage address, where you would like to store the message. The second parameter describes how many characters are expected, while the third parameter describes a timeout period. Timeout is used to prevent eternal waiting periods if less data than expected do arrive. If after a given timeout period no more data arrive, the function will be aborted and the first character in the received string will be replaced by a 'T' (=Timeout). If you however define a third parameter '0', the function will not abort, but wait, until the last of the expected number of characters has arrived.

Example:

The string „Go Ahead“ should be received and we want to be sure all characters do have arrived at the ASURO before we continue operation.

```
#include "asuro.h"
int main(void) {
    char data[8];           // allocate storage
    Init();
    SerRead (data,8,0);    // Read data
    MotorDir(FWD,FWD);
    MotorSpeed(120,120);
    while(1);              // Eternal loop
    return 0;
}
.
.
.
```

9.2.10. void LineData(unsigned int *data)

This function has been developed to read the light intensity of both phototransistors at the bottomside of ASURO. You will have to define an address pointer to a dual integer location in memory. The function will transfer the AD-converter values of measurement data by both phototransistors. The first integer value represents the converter value of the left (T9), the second integer value represents the converter value of the right (T10) phototransistor. Maximum intensity (brightness) is referenced by '1023', while total darkness is referenced by '0'. Normally these extreme values will not be found, and in practice measurement values will be found in between.

Example:

Reading the light intensity of both phototransistors (T9, T10)

```
unsigned int data[2];      //Allocate storage
.
.
LineData(data);
```

data[0] contains the value measured by the left phototransistor (T9)

data[1] contains the value measured by the right phototransistor (T10)

Of course you would like an example as a complete program:

```
#include "asuro.h"           // Line tracing the easiest way
int main(void) {
    unsigned int data[2];    // Allocate storage
    Init();
    FrontLED(ON);           // Switch ON line trace illumination
    MotorDir(FWD,FWD);      // Both engines go ahead
    while(1){               // Eternal loop, ASURO should follow
                            // a line eternally
        LineData(data);     // Read brightness data from Phototransistors
        if (data[0]>data[1]) // left brighter than right
            {MotorSpeed(200,150);} // ... speed up left motor
        else
            {MotorSpeed(150,200);} // ... speed up right motor
    }
    return 0;
}
```

9.2.11. void OdometrieData(unsigned int *data)

The function scans the reflected light-sensor: Both LED (D13, D14) are activated and the function returns the AD-converter values of the phototransistors (T11, T12). As in the function LineData() a storage area with two integer values must be provided, which will be filled by the function. The first integer value contains the AD-value delivered by the left (T11), the second integer value contains the AD-value delivered by the right (T12) phototransistor. Maximum brightness is referenced by a value '0' while absolute darkness is represented by value '1023'⁵. Normally these extreme values will not be found, and in practice measurement values will be found in between.

Example:

Scanning the reflected light-sensors.

```
unsigned int data[2]; //Allocate memory
.
.
OdometrieData(data);
```

data[0] contains data from the left phototransistor (T11)

data[1] contains data from the right phototransistor (T12)

Just to prevent misinterpretations: OdometrieData() does not provide the number of revolutions, but the actual illumination at the reflected light-sensors. Discerning bright and dark levels, counting light-dark transitions and counting the number of revolutions is left to be a programmer's job.

⁵ To simplify the hardware circuit these values do not correspond to the values found in the line tracing module.

9.2.12. unsigned char PollSwitch (void)

This function scans the position of switches (K1-K6) and returns one byte, containing information, which switches have been activated. Switch 1 will set the first bit number 5, switch 2 will set the second bit, ... switch 6 will set bit number 5,

Bit0 (1) -> K6
Bit1 (2) -> K5
Bit2 (4) -> K4
Bit3 (8) -> K3
Bit4 (16) -> K2
Bit5 (32) -> K1

Activating switches 1,3 and 5 will cause the function to return 42 ($32+8+2 = 42$).

To be sure, the function may be called several times in sequence to provide a “correct” answer. Capacitor C7 first must be discharged, which may take some time. If you scan the A/D-converter prematurely, some unreliable data may be delivered.

Example:

```
unsigned char taste;  
.  
.  
switch = PollSwitch();  
if (switch>0) {MotorSpeed(0,0);}
```

Well, that's it. Now it's up to you to be creative.

Part IV. Appendices

A. Partslist

Besides a table-tennis ball the following parts are needed to build an ASURO:

- 1x Printed circuit board ASURO
- 2x Motors Type Igarashi 2025-02
- 1x Diode 1N4001
- 8x Diodes 1N4148
- 4x Transistors BC 327/40 or BC 328/40
- 4x Transistors BC 337/40 or BC 338/40
- 1x Integrated circuit CD 4081BE
- 1x Processor ATmega 8L-8PC (preprogrammed)
- 1x IR-receiver SFH 5110-36
- 1x IR-LED SFH415-U
- 2x phototransistors SFH300
- 3x LEDs 5mm red bright diffuse or asymmetric wide-angle
- 1x Dual-LED 3mm
- 2x Side-phototransistors LPT80A
- 2x Side-LEDs IRL80A
- 1x Crystal 8MHz
- 2x Elco 220_F at least 10V RM 3,5/10
- 4x ceramic capacitors 100nF RM 5,08
- 2x ceramic capacitors 4,7nF RM 2,54
- 1x 100Ω 1/4 W 5%
- 2x 220Ω 1/4 W 5%
- 4x 470Ω 1/4 W 5%
- 10x 1kΩ 1/4 W 5%
- 1x 1kΩ 1/4 W 1%
- 3x 2k 1/4 W 1%
- 2x 4,7k 1/4 W 5%
- 1x 8,2k 1/4 W 1%
- 1x 10k 1/4 W 1%
- 1x 12k 1/4 W 1%
- 1x 16k 1/4 W 1%
- 1x 20k 1/4 W 5%
- 1x 33k 1/4 W 1%
- 1x 68k 1/4 W 1%
- 1x 1M 1/4 W 5%
- 3x Socket 14 pol.
- 6x Detector switch
- 1x Switch (main on/of)
- 1x Battery holder
- 1x Battery clip
- 1x Jumper
- 1x Jumper pins 2pole RM 2.5
- 2x Cogwheel 10/50 cogs; 3,1mm drilling hole Module 0,5
- 2x Cogwheel 12/50 cogs; 3,1mm drilling hole Module 0,5
- 2x Pinion gear 10 (oder 12) cogs; drilling hole 1,9mm Module 0,5
- 2x Collar for 3mm-axle

A. Partlist

4x Cable binder
1x Cable binder releaseable
2x Rubber tires 38mm
2x Messing shaft 42mm long 3mm diameter,
2x Messing shaft 24,5mm lang, 3mm diameter
ca. 15 cm wire red 0,14mm_
ca. 15 cm wire black 0,14mm_
2x Encoder sticker (see [2.4](#))

The additional RS-232-IR-transceiver will be equipped with the following parts:

1x Printed circuit board IR-RS232-transceiver
3x Diodes 1N4148
1x Zenerdiode ZPD5.1
1x Transistor BC547 A,B or C or BC548 A,B or C
1x Integrated circuit NE555N
1x IR-receiver SFH 5110-36
1x IR-LED SFH415-U
1x Elco 100_F at least 16V RM 2,5/6
2x ceramic capacitors 100nF RM 5,08
1x ceramic capacitors 680pF RM 2,54
1x 220 Ω 1/4 W 5% or better
1x 470 Ω 1/4 W 5% or better
1x 4,7K Ω 1/4 W 5% or better
1x 10K Ω 1/4 W 1%
2x 20K Ω 1/4 W 5% or better
1x Trimmer 10k vertically mounted RM 2,5/5
1x Socket 8 pole
1x 9-pol. SUB-D-entry

Optional there is a USB-IR-tranceiver available:

B. ASURO DIAGRAM

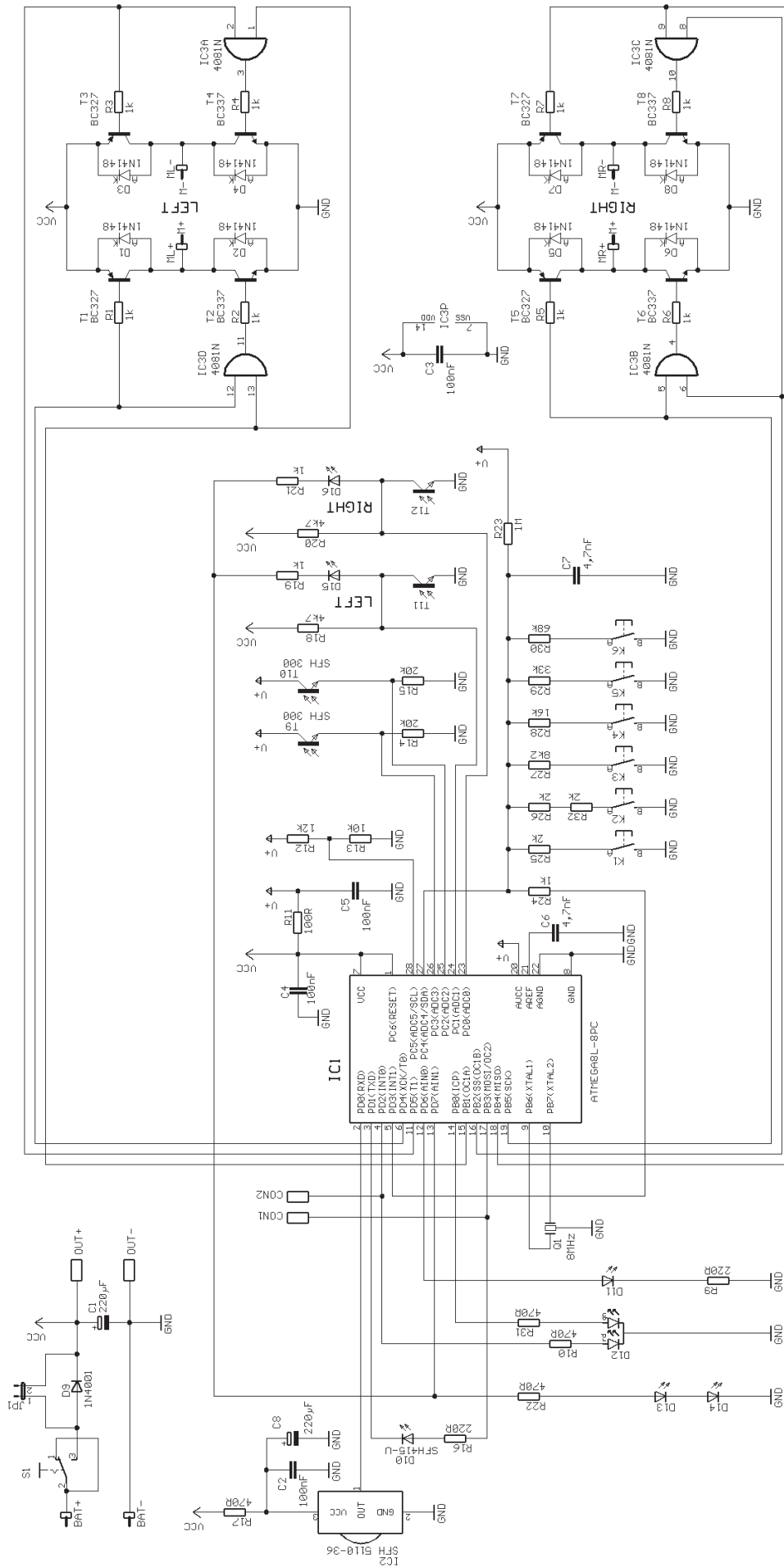

C. RS-232 Transceiver

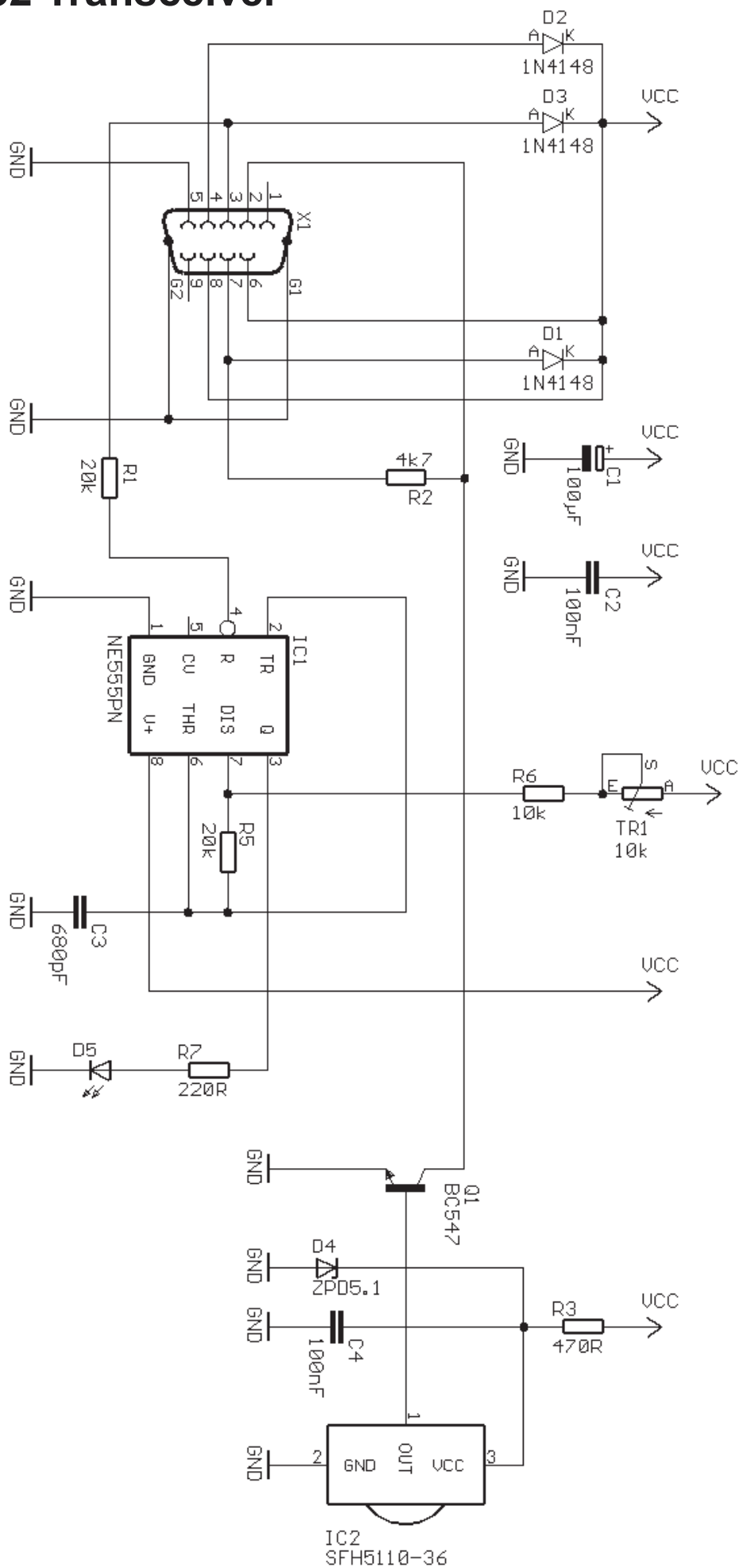

D. USB Transceiver

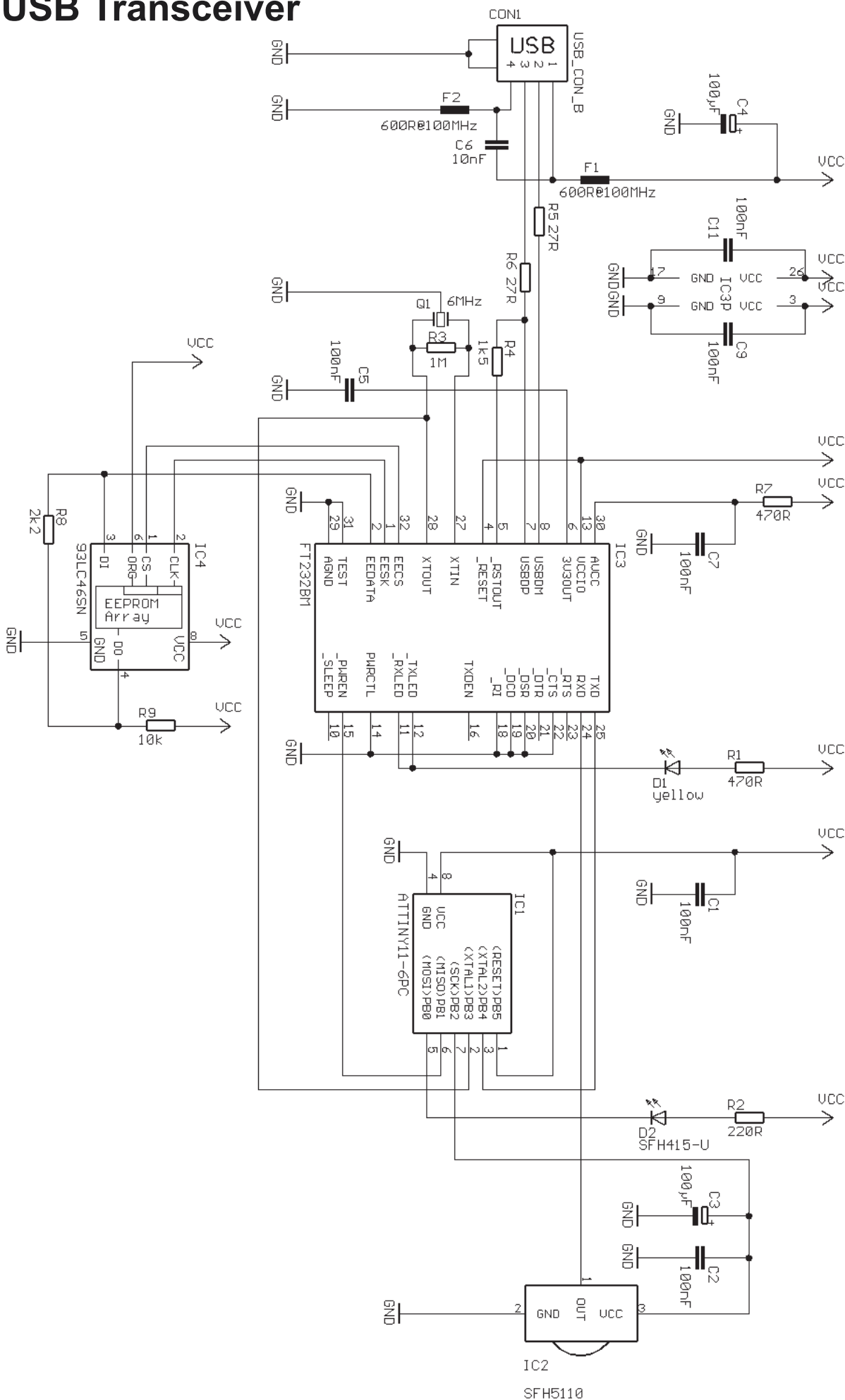

E. Block diagram ASURO

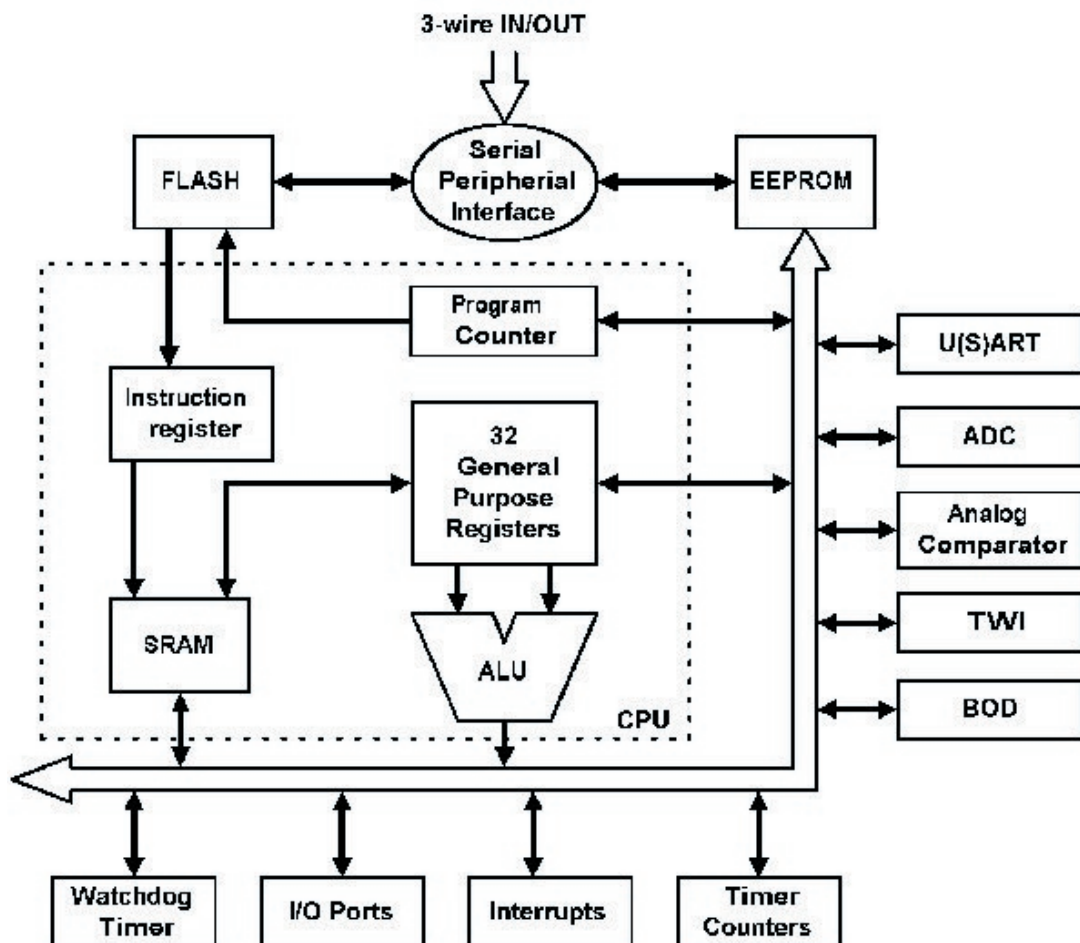
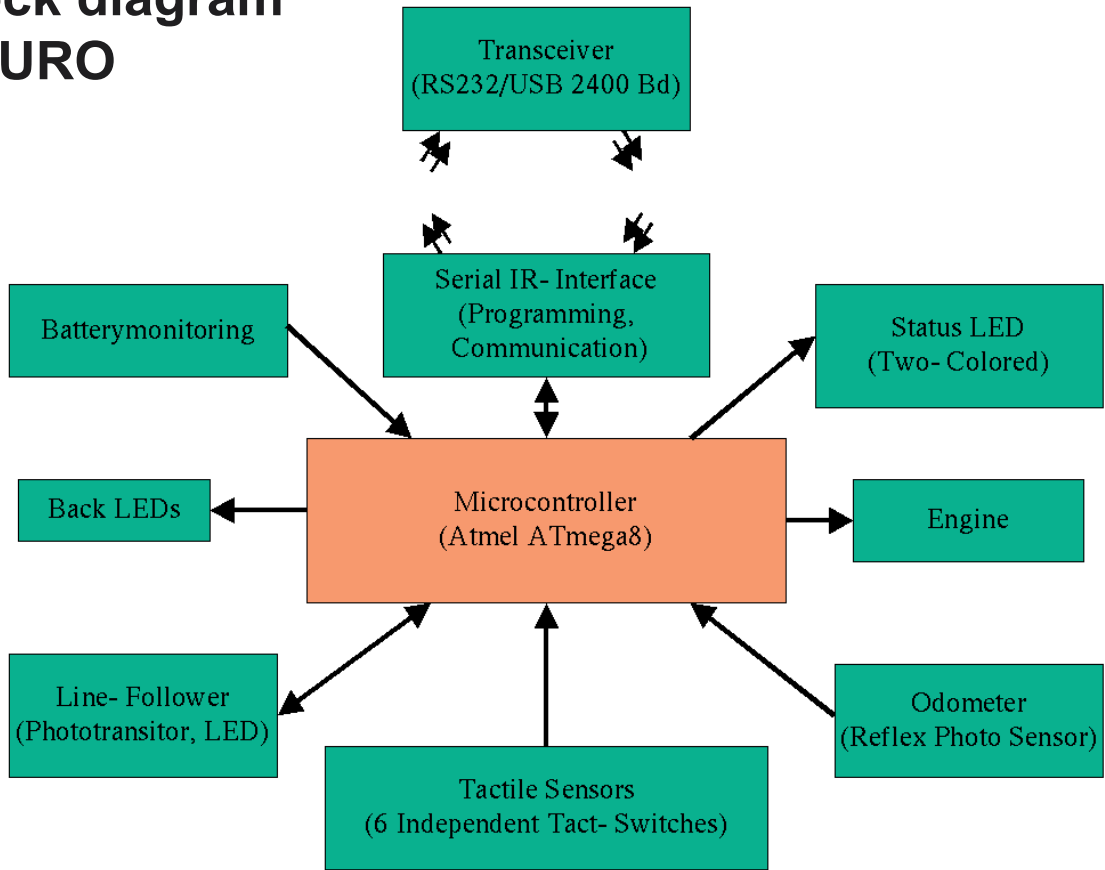

F. Block diagram PIC processor

G. Contents ASURO KIT

