



DualCut Jig Saw Blades
See Page C4



795 Outside Micrometer
See Page 4



505P-7 Prtractor
See Page C1



445 Depth Micrometer
See Page 4



798 Caliper
See Page 2

798A Electronic Calipers

- IP67 protection against coolant, water, dirt and dust
- Fine adjustment
- Heavy-duty 3.5mm bar and slide
- Hardened stainless steel measuring surfaces
- Linear accuracy meets DIN862
- Slide lock
- .310" LCD display
- CR2032 3V battery

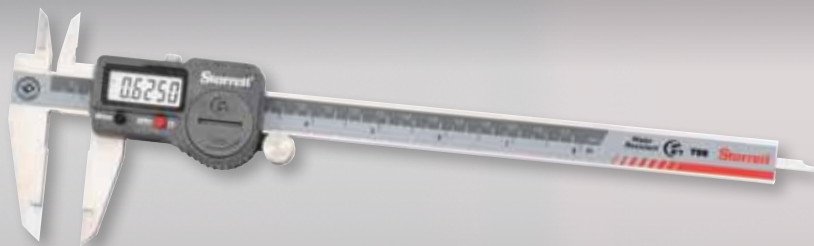

- In/mm conversion
- Zero at any position
- Auto-off after 30 minutes of non-use and display reactivation with no loss of position



Cat No.	EDP	Range	Grad	Description	List	Sale
798A-6/150	20798	0-6" (0-150mm)	.0005"	Electronic Caliper w/o Output	\$175.00	\$157.50
798A-8/200	20799	0-8" (0-200mm)	(0.01mm)	Electronic Caliper w/o Output	223.00	200.70
798A-12/300	20800	0-12" (0-300mm)		Electronic Caliper w/o Output	332.00	298.80

799 Electronic Calipers

- Lightweight, comfortable ergonomic design
- Large LCD display
- Zero at any position
- Automatic off after 5 minutes with no loss of position
- Accuracy meets DIN862
- Resolution: .0005" (0.01mm)
- Includes fitted plastic case



Cat No.	EDP	Range	Grad	Description	List	Sale
799A-6/150	67410	0-6" (0-150mm)	.0005"	Electronic Caliper, w/o Output	\$140.00	\$119.00
799A-8/200	67412	0-8" (0-200mm)	(0.01mm)	Electronic Caliper, w/o Output	198.00	168.30
799A-12/300	67621	0-12" (0-300mm)		Electronic Caliper, w/o Output	372.00	316.20

5006 Electronic Groove Caliper

- Ideal for measuring internal and external grooves on large workpieces
- Hardened stainless steel construction
- Coolant resistant
- Generous diameter and jaw depth capacities
- CR2032 lithium battery provides over 1 year life with normal use
- Resolution: 0.0005"/0.01mm
- RS232 output
- Includes wooden case



Cat No.	EDP	Outside Range	Inside Range	Description	List	Sale
5006BZ-14/350	14589	0-12.5" (0-318mm)	1.654-15" (42-381mm)	Electronic Groove Caliper	\$968.00	\$871.20

1202 Dial Calipers



- Sharp, clear dial graduations
- Hardened stainless steel bar, measuring surfaces, rack, gears and depth rod
- Sharp, black graduations on the satin finished bar
- Thumb-operated fine adjustment roll
- Lock screws for sliding jaw and adjustable dial bezel
- Knife-edge contacts

Cat No.	EDP	Range	Description	List	Sale
1202-4	68814	0-4"		\$70.00	\$59.50
1202-6	66964	0-6"	.001"	98.00	88.20
1202-8	66979	0-8"	.100" per revolution	139.00	125.10
1202-12	66980	0-12"		202.00	181.80
1202F-6	68931	0-6"	Fractional Dial Caliper	98.00	88.20
1202F-8	69757	0-8"	1/64th on yellow scale	139.00	125.10
1202F-12	69758	0-12"	.01" on white scale	202.00	181.80

125 Vernier Calipers

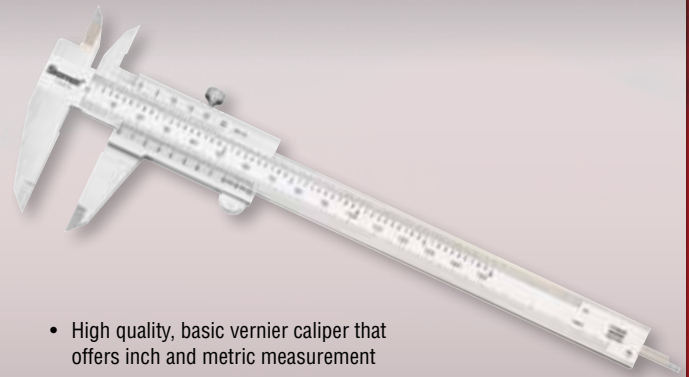

- High quality, basic vernier caliper that offers inch and metric measurement
- Lock screw for sliding jaw
- Hardened stainless steel depth rod
- Sharp, black graduations on the satin finished bar
- .001" (0.020mm) Grads

Cat No.	EDP	Range	List	Sale
125MEA-6/150	61660	0-6" (0-150mm)	\$92.00	\$82.80
125MEA-12/300	61886	0-12" (0-300mm)	195.00	175.50

5004 Electronic Depth Gages

- Hardened stainless steel construction
- Coolant resistant
- RS232 data transmission port
- CR2032 lithium battery will provide over a year of life with normal use
- Protective wooden case
- Resolution: 0.0005"/0.01mm
- Includes offset attachment



Cat No.	EDP	Description	List	Sale
5004BZ-16/400	14584	0-16" (0-400mm) Range	\$1,047.00	\$942.30
5004BZ-24/600	14586	0-24" (0-600mm) Range	1,320.00	1,188.00

Tool Sets

S905AZ Select Precision Measuring Tool Set

- Basic tools and a test indicator for a wide variety of measurements
- Includes case



S766A Basic Electronic Tool Set (without output)

- Basic electronic starter set with slide calipers and 1" (25mm) micrometer
- Includes case



S909Z Basic Precision Measuring Tool Set

- Includes three of the most commonly used precision tools.
- Includes case



Cat No.	EDP	Description	List	Sale
S766AZ	12206	Basic Electronic Tool Set (w/o output): 799A-6/150 6"/150mm Caliper & 3732XFL-1 1"/25mm Micrometer	\$357.00	\$303.45
S905AZ	65805	Select Precision Measuring Tool Set: T231XRL 1".25mm Micrometer, 120A-6 6"/150mm Dial Caliper, C604RE-6 6"/150mm Rule, 711FSA Last Word® Dial Test Indicator	522.00	469.80
S909Z	65122	Basic Precision Measuring Tool Set: T436.1XRL-1 1"/25mm Micrometer, 120A-6 6"/150mm Caliper, C604R-6 6"/150mm Rule	333.00	299.70

795 & 796 Electronic Outside Micrometers

- IP67 level of protection against coolant, water, dirt and dust
- Balanced, tapered frame and hard, stable one piece spindle
- Zero tool at any position – retain and return to true zero
- Carbide faces
- Large, easy-to-read LCD readout
- Micro-lapped carbide measuring faces
- Auto-off after 20 minutes of nonuse
- Inch/millimeter conversion
- Measurement HOLD button
- Resolution: .00005" (0.001mm)
- Accuracies:
Inch: $\pm .0001$ "
Metric: $\pm .002$ mm



Cat No.	EDP	Range	Description	List	Sale
795XFL-1	67827		Friction Thimble, With Carbide Faces, With Output	\$207.00	\$186.30
795XRL-1	69085	0-1"	Ratchet Stop, With Carbide Faces, With Output	207.00	186.30
796XFL-1	67828	(0-25mm)	Friction Thimble, With Carbide Faces, Without Output	153.00	137.70
796XRL-1	69089		Ratchet Stop, With Carbide Faces, Without Output	153.00	137.70

436.1 Outside Micrometers

- No glare Starrett satin chrome finish
- Staggered lines and distinct figures for readability
- Rigid steel frame ribbed for extra strength
- Combination ratchet and speeder for uniform pressure and quick adjustment
- Balanced frame and thimble
- Micro-lapped measuring faces
- Extremely hard and stable one-piece spindle
- Tapered frame ideal for narrow slots and tight places



Cat No.	EDP	Range	Grad	Description	List	Sale
T436.1XRL-1	67997	0-1"		Ratchet Stop, Lock Nut, Carbide Faces	\$117.00	\$105.30
T436.1XFL-1	67999			Friction Thimble, Lock Nut, Carbide Faces	117.00	105.30
T436.1XRL-2	68005			Ratchet Stop, Lock Nut, Carbide Faces	138.00	124.20
T436.1XFL-2	68007	1-2"	.0001"	Friction Thimble, Lock Nut, Carbide Faces	138.00	124.20
T436.1XRL-3	68013			Ratchet Stop, Lock Nut, Carbide Faces	171.00	153.90
T436.1XFL-3	68015	2-3"		Friction Thimble, Lock Nut, Carbide Faces	171.00	153.90

3206 Micrometer Stand

- Converts outside micrometer to a sturdy bench gage for batch inspection of small parts
- Handy bench vise or assembly fixture
- Ball joint construction
- Positive lock on the base
- Base dimension is 6-3/8" long x 3-1/2" wide x 3/4" thick
- Accommodates all Starrett 1/2" (13mm) and 1" (25mm), 2 and 2A 2" and 210, 220, 483, 485, 569 special purpose outside micrometers



Cat No.	EDP	Description	List	Sale
3206	68917	Outside Micrometer Stand	\$89.00	\$75.65

445 Depth Micrometers

- Range: .001" or 0.01mm
- 3" (75mm) base and 5/32" (4mm) diameter measuring rods
- Combination ratchet and speeder
- Ring-type lock nut



Cat No.	EDP	Description	List	Sale
445AZ-3RL	52208	0-3" Range	\$202.00	\$181.80
445AZ-6RL	52212	0-6" Range	244.00	219.60
445AZ-9RL	52216	0-9" Range	301.00	270.90
445AZ-12RL	67117	0-12" Range	406.00	365.40

649 Spindle Squares

- Patented design
- Ground gaging surface
- 3/8" inch shank diameter
- 4" (100mm) between contact points
- Solid steel body construction with durable black wrinkle finish
- Fully assembled with two AGD Group 2 dial indicators
- Approximately 4 lbs with custom case
- Approximately 6-3/4" (172mm) wide and 5-1/2" (140mm) from the top of shank to the end of the contact points



Cat No.	EDP	Description	List	Sale
649-1	52080	Spindle Square .250" range	\$180.00	\$162.00
649-5	52081	Spindle Square .125" range	190.00	171.00
649-1M	52082	Spindle Square 2.5mm range	190.00	171.00

3089 Dial Bore Gages

- Offers precision, a full compliment of features and excellent value
- Ergonomic design with non-slip insulating grip
- 2-point carbide contacts for extended wear
- All anvils laser marked for easy selection
- Gage chart for quick and easy anvil selection
- Resolution: .0005"
- Includes sturdy aluminum case



Cat No.	EDP	Description	List	Sale
3089Z-131-715J	12456	0.7-1.5" Depth	\$210.00	\$189.00
3089Z-131-1424J	12457	1.4-2.4 Depth	210.00	189.00
3089Z-131-26J	12458	2-6" Depth	235.00	211.50

823 Tubular Inside Micrometer Sets

- Tubular measuring rods are lightweight, yet extremely rigid
- Each rod is marked with length
- Hardened and ground anvils on rods are adjustable for length
- Head anvil is hardened and ground
- Interchangeable anvils
- Quick reading figures – every thousandth numbered
- Convenient 5-1/2" (140mm) handle
- Protective Case



Cat No.	EDP	Description	List	Sale
823AZ	53050	1-1/2 - 8" Range with 5 Rods	\$248.00	\$223.20
823BZ	53052	1-1/2 - 12" Range with 8 Rods	303.00	272.70

78 & 78M Internal Micrometer Bore Gages

- 3 point ground carbide contact points seat the internal micrometer faster and more accurately than the spherical contacts found in other gages
- Tungsten carbide measuring faces on all 3-point heads above 1/2"
- Ratchet stop
- Blind bore measuring capability above 1/2" diameter
- Each micrometer bore gage is furnished in a fitted case, complete with setting ring, contacts, wrenches, and instructions
- Resolution .00025"



Cat No.	EDP	Range	List	Sale
78XTZ-312	68129	1/4-5/16"	\$675.00	\$573.75
78XTZ-375	68130	5/16-3/8"	636.00	540.60
78XTZ-500	68131	3/8-1/2"	640.00	544.00
78XTZ-625	68132	1/2-5/8"	603.00	512.55
78XTZ-750	68133	5/8-3/4"	621.00	527.85
78XTZ-1	68134	3/4-1"	701.00	595.85
78XTZ-138	67674	1-1 3/8"	970.00	824.50
78XTZ-2	67675	1 3/8-2"	991.00	891.90
78XTZ-258	67676	2-2 5/8"	1,218.00	1,035.30
78XTZ-314	67677	2 5/8-3 1/4"	1,249.00	1,061.65
78XTZ-4	67678	3 1/4-4"	1,675.00	1,423.75

25 Dial Indicators, Jeweled

- AGD Group 2
- 2-1/4" Dial Indicators
- Shockless, hardened steel gear train and jewel bearings
- Lug-on-center backs
- .001" Graduations
- Stem cap is standard – top lift available when specified
- Continuous reading double dial with direct reading count hands



Cat No.	EDP	Range	Dial Reading	Grad	List	Sale
25-341/5J	53285	.500"			\$123.00	\$110.70
25-341J	53287	1.000"	0-50-0		123.00	110.70
25-441/5J	53293	.500"		.001"	123.00	110.70
25-441J	53295	1.000"	0-100		123.00	110.70

711 Last Word® Test Indicators

- Smooth, jeweled lever action
- Positive reversing switch
- Hard chrome-plated ratchet contact point
- Swiveling tubular body
- Easy reading half yellow dials
- .030" Range, .001" Grad
- 711GCSG includes 3 contact points, body clamp, universal friction holder with shank, universal shank with long and short arms, double-jointed attachment, height gage attachment, surface gage attachment, coupling with 3/16" (4.8mm) hole



Cat No.	EDP	Description	List	Sale
711FSZ	52929	Indicator with Body Clamp	\$135.00	\$128.25
711GCSZ	52943	Indicator Complete with All Attachments	200.00	190.00

708 & 709 Dial Test Indicators with Dovetail Mounts

- Angled head with 1-3/8" (35mm) dial
- Narrow body for inreach ability
- Three dovetail positioning mounts
- Precision gear-driven design with smooth, jeweled movement
- Satin chrome finish and fitted case
- Frictionally adjustable contacts reverse automatically, maintaining clockwise rotation



Cat No.	EDP	Range	Grad	Description	List	Sale
708AZ	64212	.010"	.0001"	without Attachments	\$253.00	\$227.70
708ACZ	64217			with Attachments	319.00	287.10
709AZ	64214	.030"	.0005"	without Attachments	216.00	194.40
709ACZ	64219			with Attachments	263.00	236.70

81 Dial Indicators

- AGD Group 1 with lug-on-center back
- Rugged and simple unit construction with a "universally fitting" design
- Shockless, single bridge gear unit and plate assembly with a hardened stainless steel gear train and jewel bearings
- Light but sturdy case, with a hardened, precision stainless steel rack
- Hardened stainless steel bottom stems
- Easy readability with balanced graduation



Cat No.	EDP	Range (One Rev.)	Total Range	Dial Reading	Grad	List	Sale
81-141J	53400	.100"	.250"	0-50-0	.001"	\$123.00	\$110.70
81-241J	53428		.125"	0-100		123.00	110.70
81-131J	53388	.050"	.125"	0-25-0	.005"	123.00	110.70

3600 Electronic Indicators

- AGD Group 2
- Simple, powerful, easy-to-use
- Large, easy-to-read LCD
- Reverse travel
- Zero at any position
- Lug-on-center back plus additional flat back
- 3/8" diameter stem
- 4-48 spindle thread



Cat No.	EDP	Range	Resolution	List	Sale
3600-5	68813	.500" (12.5mm)	.0005" (0.01mm)	\$150.00	\$127.50
3600M-5	68918	12.7mm	0.01mm	150.00	135.00

2700 Wisdom® BASIC Electronic Indicators

- Glass scale with accuracy of ± two resolutions
- Inch/mm conversion, plus or minus travel direction, maximum reading hold, zero at any position, auto-off after 10 minutes of nonuse
- Rotating bezel
- RS232 output port



Cat No.	EDP	Range	Resolution	List	Sale
2720-1	65816	.600" (15mm)	.0001"	\$518.00	\$466.20
2730-1	65820	1" (25mm)	(0.002mm)	545.00	490.50
2740-1	65824	2" (50mm)		891.00	801.90
2710-3	65813			501.00	450.90
2730-0	65819			590.00	531.00
2740-3	65825			852.00	766.80
F2750-1	65847			1,412.00	1,270.80
F2750-3	65848			1,375.00	1,237.50

196 Universal Back-Plunger Dial Indicators

- Inch reading
- .001" graduations
- .200" range
- 1/4" shank diameter
- Accurate, reliable, and simple to operate
- Rugged, with few moving parts
- Smooth operating
- Case included

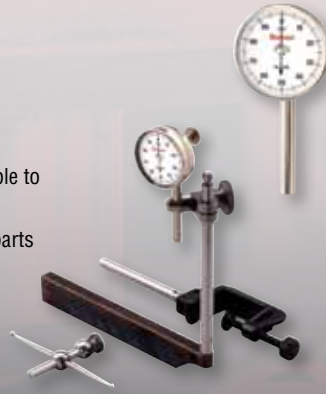

Cat No.	EDP	Description	List	Sale
196A1Z	50697	Universal Back-Plunger Dial Indicator	\$201.00	\$180.90
196B1	50699	Universal Back-Plunger Dial Indicator	116.00	104.40

679 Inspection Scopes

- Three light intensity settings
- Water resistant shaft with high quality metal tip
- Full color image sensor and dual solid state LEDs provide imaging and illumination
- 2.5" full color LCD screen displays live video from the digital camera
- Includes rugged, protective case
- High quality product made in the USA



Cat No.	EDP	Description	List	Sale
679-3	60360	Inspection Scope w/3' Shaft	\$400.00	\$360.00
679-6	60361	Inspection Scope w/6' Shaft	450.00	405.00

765 Electronic Snap Gage

- Balanced and compact for comfortable handling
- Simple, logical controls
- Easy-to-read LCD
- Light-weight aluminum frame
- Inch/millimeter conversion
- Single, 3-volt CR2032 battery with easy access
- Zero at any position
- Manual ON/OFF with auto-off after 7 minutes of non-use



- Linear Accuracy: ± 0.0010 ($\pm 0.02\text{mm}$)
- 0-1/2" (0-12.7mm) Range
- Resolution: .0005" (0.01mm)

Cat No.	EDP	Description	List	Sale
765A	67659	Electronic Snap Gage without Output	\$110.00	\$99.00

5003 Carbon Fiber Snap Gages

- Carbon fiber insulated handle
- Precise aluminum body
- Adjustable support ensures accuracy
- .200" (5mm) indicator range

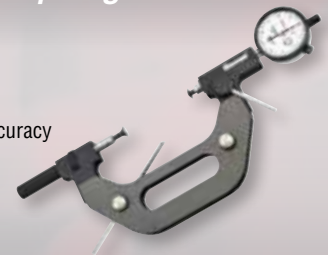

Cat No.	EDP	Range	Grads	List	Sale
5003Z-611-2J	12980	0-2" (0-50mm)	.001"	\$1,465.00	\$1,391.75
5003Z-611-4J	12981	2-4" (50-100mm)		1,636.00	1,554.20
5003Z-611-6J	12982	4-6" (100-150mm)	.0001"	1,808.00	1,717.60
5003Z-611-8J	12983	6-8" (150-200mm)		2,001.00	1,900.95
5003Z-431-2J	12984	0-2" (0-50mm)		1,371.00	1,302.45
5003Z-431-4J	12985	2-4" (50-100mm)	.0005"	1,542.00	1,464.90
5003Z-431-6J	12986	4-6" (100-150mm)		1,714.00	1,628.30
5003Z-431-8J	12987	6-8" (150-200mm)		1,907.00	1,811.65

643 Dial Depth Gage

- Knife-edge base
- Hardened and ground needle point contact
- Conical point can be precisely positioned for close work
- Point is 1/2" (12.7mm) long with a 60° included angle



Cat No.	EDP	Description	List	Sale
643JZ	52714	0-.125" Range, .0005" Grad, 0-25-0 Dial with Case	319.00	287.10

98 Machinists' Levels

- Seasoned cast iron base, precision-machined on reference surfaces with black wrinkle finish on non-machined surfaces
- Involute groove running the length of the base provides a reliable seat for round work
- Ground and graduated vials housed in a satin finished brass tube
- Main and cross test vials allow simultaneous leveling in both directions

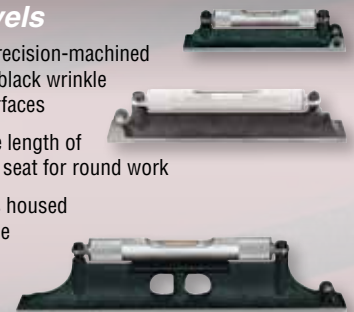

Cat No.	EDP	Description	List	Sale
98-6	50441	6" (150mm) with Cross Test Vial	\$104.00	\$93.60
98-8	50442	8" (200mm) with Cross Test Vial	128.00	115.20
98-12	50443	12" (300mm) with Ground Single and Cross Test Vials	181.00	162.90

11 Combination Squares & Heads

- Cast iron heads
- Hardened steel, machine divided blade with regular or satin chrome finish
- Scriber and reversible lock bolt
- Spirit level (except 4")
- 4R grads - 8ths, 6ths, Quick Reading 32nds, 64ths



Cat No.	EDP	Description	List	Sale
11H-4-4R	50049	4", 4R Grad, Regular Blade	\$57.00	\$51.30
11H-12-4R	50055	12", 4R Grad, Regular Blade	65.00	58.50
C11H-6-4R	56362	6", 4R Grad, Satin Chrome Blade	74.00	66.60
C11H-12-4R	56366	12", 4R Grad, Satin Chrome Blade	78.00	70.20
C11H-24-4R	56374	24", 4R Grad, Satin Chrome Blade	135.00	121.50
H11-1224	50071	Cast Iron Square Head	43.00	38.70
C11-1224	50074	Cast Iron Center Head	30.00	27.00

435 & 9 Combination Squares

- Cast iron heads with black wrinkle finish
- Scriber & reversible lock bolt
- Spirit level in both square and protractor heads
- Direct reading double 180° protractor scale
- Hardened steel, machine divided blade with satin chrome finish
- 4R grads - 8ths, 16ths, Quick Reading 32nds, 64ths

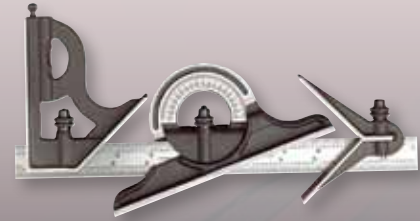

Cat No.	EDP	Description	List	Sale
C435-12-4R	66682	12", Reversible Protractor Head	\$195.00	\$175.50
C9-12-4R	50046	12", Non-Reversible Protractor Head	195.00	175.50

Blades for Combination Squares, Sets & Bevel Protractors

- Inch Blades fits Combination Squares, Sets and Bevel Protractors

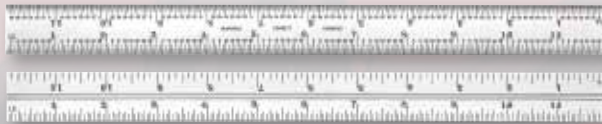

Cat No.	EDP	Length	Finish	Grads	List	Sale
B12-4R	50083		Regular	4R	\$37.50	\$33.75
CB12-4R	50084	12"			39.50	33.58
CB12-16R	50087		Satin Chrome	16R	55.00	46.75
CB18-4R	50089	18"		4R	77.00	65.45
CB18-16R	50091		Satin Chrome	16R	88.00	74.80
B24-4R	50092		Regular	4R	78.00	70.20
CB24-4R	50093	24"			95.00	80.75
CB24-16R	50096		Satin Chrome	16R	107.00	90.95

622 6" Steel Rule with Decimal Equivalent

- Accurate, machine-divided graduations
- Fraction and decimal equivalent table
- Spring-tempered steel with no-glare satin finish



Cat No.	EDP	Description	List	Sale
C622R-6	56660	10R	22.50	20.25

3020 Toolmakers' Grade Stainless Steel Squares

- High quality, non-graduated toolmakers' square
- Squareness accuracy to .0002" (0.005mm) for every 6" (150mm)
- Hardened, ground and lapped stainless steel on both blade and beam
- Inner corner of beam machined for clearance

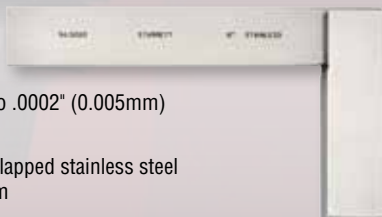

Cat No.	EDP	Description	List	Sale
3020-3	12225	2-31/32" (75mm) Blade; 1-31/32" (50mm) Beam	\$82.00	\$65.60
3020-6	12227	5-29/32" (150mm) Blade; 3-29/32" (100mm) Beam	150.00	120.00
3020-12	12228	12-1/32" (300mm) Blade; 6-7/8" (175mm) Beam	309.00	247.20

Steel Rules

- Fine quality steel
- Accurate, precise and readable



Cat No.	EDP	Length	Description	Grads	List	Sale
C303R-6	51334			3R	\$18.00	\$16.20
C305R-6	51347		Full-Flexible	5R	19.50	17.55
C310K-6	56701			10R	19.50	17.55
C316R-6	51374			16R	20.00	18.00
C304SRE-6	51343		Semi-Flexible, End Graduations	4R	20.50	18.45
C604R-6	52678	6"	Spring-Tempered	4R	19.50	17.55
CH604R-6	52673		Spring-Tempered, Reversible Hook	4R	24.00	21.60
C604RE-6	52660		Spring-Tempered, End Graduations	4R	21.00	18.90
C636EM-6	57064		Spring Tempered, mm & inch Grads	36	20.50	18.45
C305R-12	51348			5R	39.00	35.10
C316R-12	51375		Full-Flexible	16R	41.00	36.90
C604R-12	52679	12"	Spring-Tempered	4R	32.50	29.25
CH604R-12	52674		Spring-Tempered, Reversible Hook	4R	42.50	38.25
C636-300	52635	300mm	Spring Tempered, mm & inch Grads	36	43.00	38.70
C604R-18	52680	18"	Spring-Tempered	4R	63.00	56.70
C304R-24	56645			4R	83.00	74.70
C305R-24	51350	24"	Full-Flexible	5R	86.00	77.40
C604R-24	52681		Spring-Tempered	4R	81.00	72.90

3753A Electronic Depth Gages without Output

- Large easy-to-read display
- Hardened, stainless steel bar
- Fine adjustment thumb roll
- Slide lock
- Inch/millimeter conversion
- Zero at any position
- Linear Accuracy: $\pm 0.01"$ ($\pm 0.03\text{mm}$)
- Resolution: $.0005"$ (0.01mm)

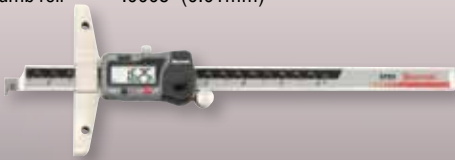

Cat No.	EDP	Description	List	Sale
3753A-6/150	12258	0-6" (0-150mm) Range	\$241.00	\$204.85
3753A-12/300	12260	0-12" (0-300mm) Range	320.00	272.00
3648-180	12261	180mm Base Extension	38.50	34.65
3648-260	12262	260mm Base Extension	48.00	43.20
3648-320	12263	320mm Base Extension	57.00	51.30

3752 Height Gages

- Large LCD display reads to $.0005"$ or 0.01mm
- Clear bar graduations in $.100"$ and 5mm increments
- Instant inch-millimeter conversion
- "Hold" control feature retains a reading at any position
- Large positive action keypad
- Ability to retain and return to the true zero reading of the height gage



Cat No.	EDP	Description	List	Sale
3752-12/300	68815		\$705.00	\$669.75
3752-24/600	68816		1,155.00	1,097.25

898 Inspection Kits

- Allows very precise measurement for car and truck repair
- Used for tasks such as setting proper distance or alignment
- Securing a measuring fixture to a stable, reliable surface at various odd angles in tightly confined spaces
- Enables options to secure a measuring fixture to whatever surface is available
- Highly flexible configuration
- Invaluable to auto mechanics



S898-2



S898-1

Cat No.	EDP	Description	List	Sale
S898Z-1	12438	Inspection Kit, Plier, Flex Arm, Indicator	\$265.50	\$238.95
S898Z-2	12437	Inspection Kit, Plier, Mag Base, Indicator	310.00	279.00

668 Shaft Alignment Clamps

- Designed for fast, precise alignment of motors, pumps, compressors, etc.
- Black anodized aluminum design
- Rigid $3/8"$ diameter stainless steel indicator posts
- Extension plate for added radial clearance
- Heavy-duty roller chain accommodates up to a $7-1/2"$ diameter shaft

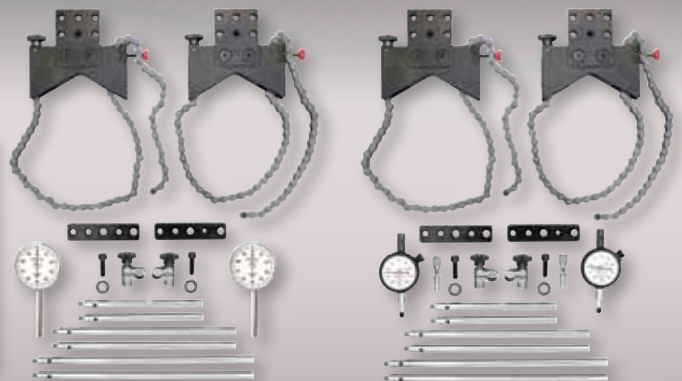

Cat No.	EDP	Description	List	Sale
S668CZ	67152	2 each: Chain Clamp, 196B5 Indicator, PT18724 Snug, Extension Plate, Posts (5", 7-7/16", 9"), with Fitted Case	\$736.00	\$662.40
S668DZ	67153	2 each: Chain Clamp, 81-141J Indicator, 657Y Indicator Attachment, PT18724 Snug, Extension Plate, Posts (5", 7-7/16", 9"), with Fitted Case	793.00	713.70

B565 Brass Drive Pin Punches

- Solid brass punches, ideal for applications where a steel punch will damage the work.
- 4" long
- Knurled finger grip.



Cat No.	EDP	Description	List	Sale
B565A	12465	4" (100mm), 1/16" (1.5mm) Dia.	\$4.80	\$4.32
B565B	12466	4" (100mm), 3/32" (2.5mm) Dia.	4.80	4.32
B565C	12467	4" (100mm), 1/8" (3mm) Dia.	4.80	4.32
B565D	12468	4" (100mm), 5/32" (4mm) Dia.	4.80	4.32
B565E	12469	4" (100mm), 3/16" (5mm) Dia.	4.80	4.32
B565F	12470	4" (100mm), 7/32" (5.5mm) Dia.	4.80	4.32
B565G	12471	4" (100mm), 1/4" (6mm) Dia.	4.80	4.32
B565H	12472	4" (100mm), 5/16" (8mm) Dia.	4.80	4.32
SB565Z	12473	Set of 8 B565A/B/C/D/E/F/G/H in Protective Fabric Pouch	41.50	37.35

117 Center Punches with Round Shanks

- Made of specially selected, hardened and tempered steel.
- Knurled finger grip.
- The points are ground at an angle
- Tips are accurately centered.



Cat No.	EDP	Description	List	Sale
117AA	50482	3" (75mm), 1/16" (1.5mm) Dia.	5.00	4.50
117A	50483	4" (100mm), 5/64" (2mm) Dia.	5.00	4.50
117B	50484	4" (100mm), 3/32" (2.5mm) Dia.	5.00	4.50
117C	50485	4" (100mm), 1/8" (3mm) Dia.	5.00	4.50
117D	50486	4" (100mm), 5/32" (4mm) Dia.	5.00	4.50
117E	50487	5" (125mm), 1/4" (6.5mm) Dia.	6.30	5.67
S117PC	50488	Set of 5 117AA/A/B/C/D in Plastic Pouch	30.50	27.45

818 Automatic Center Punch

- No hammer required! Just hold the punch in an upright position, press the handle down, and a built-in mechanism to strike a perfect mark
- The force can be adjusted by turning the knurled cap
- Hardened tool steel point may easily be removed for resharpening or replacement.



Cat No.	EDP	Description	List	Sale
818	53048	5" (125mm), 5/8" (16mm) Dia.	29.00	26.10

18 Automatic Center Punch

- Rugged automatic punches with all-steel handles and parts
- Internal mechanism strikes when downward pressure is applied
- Adjustable knurled cap regulates the force impact
- Spring tension is constant so marks made by the point are uniform in depth and size



Cat No.	EDP	Description	List	Sale
18A	50120	5" (125mm), 9/16" (14mm) Dia.	33.00	29.70

819 Hinge-Locating Automatic Center Punch

- Place the beveled edge into the countersunk hole in the hinge and press down on the handle
- Eliminates the risk of drilling off center
- Point is easily removed for replacement or resharpening



Cat No.	EDP	Description	List	Sale
819	53049	Hinge-Locating Automatic Center Punch with Adjustable Stroke	\$31.50	\$28.35

800 Square-Head Nail Sets

- Round, knurled grip
- Large, square head provides a large striking surface
- Beveled end prevents breakage
- Cupped punch surface
- Made of hardened and tempered steel



Cat No.	EDP	Description	List	Sale
S800PC	64131	SET of 5: One each of 800A/B/C/D/E in Protective Plastic Case	\$48.00	\$43.20

505 Prosite® Protractors

- Takes error-prone calculations out of miter cuts
- Upside down or backwards, the reading is always correct
- Scale shows angle for a miter joint and single cut
- Saves time and reduces waste
- Ideal for all building trades



Cat No.	EDP	Description	List	Sale
CP505A-12	12256	12" Combination Protractor	\$96.00	\$86.40
505A-12	67752	12" Miter Protractor	58.00	52.20
505A-7	11677	7" Miter Protractor	48.00	43.20
505P-7	12255	7" Plastic Miter Protractor	25.00	22.50

Measuring Tapes

Starrett Tough Tapes™

- High visibility rugged cases
- Ergonomic over-molded soft grip
- Smooth blade lock firmly holds blade
- High quality, value priced tape measure



Tough Tape

ProSite® Tapes

- High visibility, impact resistant case
- Ergonomic non-slip over-molded grip
- Robust cam-operated lock
- Heavy-duty, nylon coated blade
- Tough Tip® Stainless Steel Blade Protector and shock absorbing blade bumper



ProSite

Tru-Lok® Tapes

- Industrial quality with heavy-duty blades
- Tough Tip® Blade Protector
- Rugged, impact resistant case



Tru-Lok

Cat No.	EDP	Description	List	Sale
MY1-25	68934	Tough Tape 1" x 25', S1 Grads	\$10.37	\$5.99
MY1-25F	12182	Tough Tape 1" x 25', Fract. Grads	10.37	5.99
MY109-25	11625	Tough Tape 1.09" x 25', S1 Grads	14.19	9.99
MY1-33	68935	Tough Tape 1" x 33', S1 Grads	14.73	9.99
MY1-8ME	12150	Tough Tape 1" x 8m/26', S9 Grads	10.37	6.99
XY1-25	67670	ProSite 1" x 25', S1 Grads	21.50	12.99
XY1-30	67672	ProSite 1" x 30', S1 Grads	24.77	15.99
C1-25	65366	Tru-Lok 1" x 25' Chrome S1 Grads	17.11	9.99
CH1-8ME12	65934	Tru-Lok 1" x 8m/26' Charcoal S12 Grads	16.26	12.99

380 Steel Straight Edges & 414 Steel General Utility Rules

- 380 Series Steel Straight Edges
- Precision ground and nicely finished to Starrett standards
- Retain shape and accuracy
- Not Beveled
- Not Graduated
- 414 Series Steel General Purpose Utility Rules
- Tempered steel
- 8ths/16ths Grad, Both Sides
- Thicker grads and numbers for readability
- 1/4" hang hole in one end

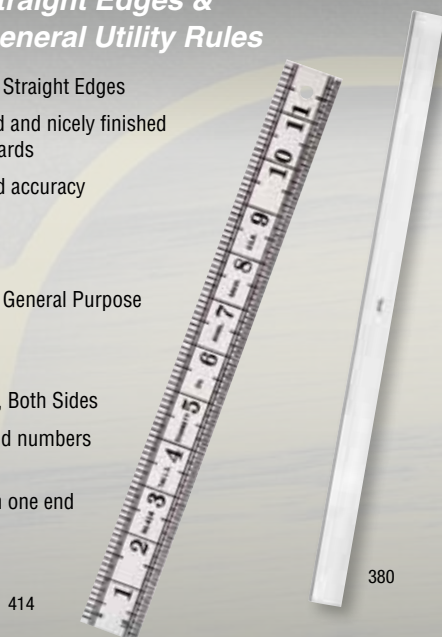

Cat No.	EDP	Description	List	Sale
380-24	51440	24" (600mm) Steel Straight Edge	\$70.00	\$63.00
380-36	51441	36" (900mm) Steel Straight Edge	158.00	142.20
414-1	51499	12" General Utility Steel Rule	29.00	26.10
414-2	51500	24" General Utility Steel Rule	45.50	40.95

85 & 92 Series' Dividers

- 85 Series Extension Dividers w/ Caliper Legs
- Complete with Divider/Inside/Outside Legs
- Rigid, light weight and easy handling
- Forged steel legs are well-shaped, properly tempered and polished
- The adjustable points may be removed and a pencil inserted
- Hardened points are bent slightly so they can be rotated and brought closer together
- 92 Series Carpenters' Dividers
- Rigid, light weight and easy handling
- Forged steel legs are well-shaped, properly tempered and polished
- The adjustable point may be removed and a pencil inserted

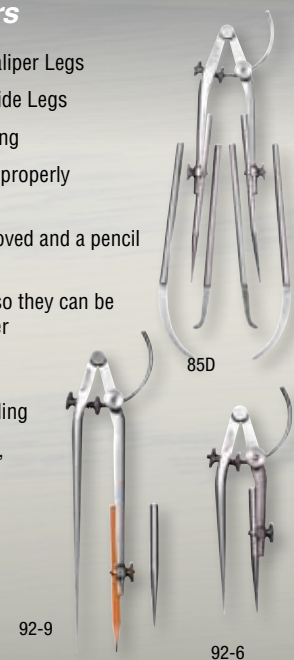

Cat No.	EDP	Description	List	Sale
85D	50401	85 Series 9" Extension Divider w/Legs	\$211.00	\$189.90
85F	50403	85 Series 12" Extension Divider w/Legs	223.00	200.70
92-6	50423	92 Series 6" (150mm) Carpenters Divider	105.00	94.50
92-9	50426	92 Series 9" (225mm) Carpenters Divider	112.00	100.80

ProSite® Professional Box Beam Levels



- Rails are made of high strength, high profile heat-treated aluminum
- 24 & 36" levels have 3 vials (2 plumb & 1 level), 48" level has 4 vials (2 plumb & 2 level)
- Glare resistant with luminous base for easy reading
- Solid block acrylic vials are shock-proof, leak-proof and fog-proof, adjustable to set grades accurately and re-calibrate and replacable
- Over-molded end caps
- Accuracy 0.25°, 1/64" over 3' (.4mm over 1m)

Cat No.	EDP	Description	List	Sale
BXY-24	36334	24"	\$93.85	\$54.99
BXY-36	36335	36"	114.83	67.75
BXY-48	36336	48"	126.98	74.99

Master Pro® Heavy Duty Die-Cast Aluminum Level



- Six-function mechanics' level will level, plumb, check 45°, check pitch, set pitch, and measure length
- Extremely stable, cast construction with working edges ground for accuracy and locking pitch/grade-screw adjustment
- Permanently marked rule on top reads
- Graduated top-sight level vial indicates pitch (1/8"/foot)
- Four tough, yellow Pyrex® Vials (2 Plumb, 1 Level, and 45°) with large bubbles and ceramic-fired lines

Cat No.	EDP	Description	List	Sale
ML-24	36032	24"	\$78.39	\$47.82

Economy Levels

MPH Series Master Pro® Hardwood Economy Levels

- Select hardwood construction, reinforced with aluminum
- 6 (4 Plumb, 2 Level) tough yellow vials
- Shock-absorbing end caps

ST Sta-Tru™ Series Economy Aluminum Levels

- Medium-duty aluminum I-beam cross section with flanged edges
- 2 (1 Plumb, 1 Level) permanently mounted vials



Cat No.	EDP	Description	List	Sale
MPH-24	68192	24" MPH Hardwood Economy Levels	\$73.43	\$44.99
MPH-36	68193	36" MPH Hardwood Economy Levels	85.02	51.86
MPH-48	68194	48" MPH Hardwood Economy Levels	101.58	64.99
ST2-18	36042	18" Sta-True Economy Aluminum Levels	15.18	9.26
ST2-24	36043	24" Sta-True Economy Aluminum Levels	17.66	10.77

Torpedo & Pocket Levels

AM-9 Aluminum Torpedo Level

- Cast aluminum frame with lapped working surfaces
- Powerful rare earth magnet
- V-grooved top working surface
- 3 Vials (1 Plumb, 1 Level, 1 45°), side and top Reading

135 Series Pocket Level

- Convex ends and satin nickel-plated finish
- 3-1/2" / 88mm long – fits in pocket with no sharp edges



Cat No.	EDP	Description	List	Sale
AM-9	36071	Aluminum Torpedo Level	\$13.94	\$8.50
135B	50571	3 1/2" (88mm) Pocket Level	24.00	21.60

Break-Away Blade Utility Knives & Replacement Blades

- Utility knife with snap-off blade
- Large and small sizes available
- Regular and hook-style blades



Cat No.	EDP	Description	List	Sale
S012	68830	Large Yellow Break-Away Blade Utility Knife	\$2.92	\$1.81
S04R	61783	Small Red Break-Away Blade Utility Knife	2.03	1.26
SB-100D	63326	100 Replacement Blades with Dispenser	29.01	17.99
KS01R	61776	10 Replacement Blades with Dispenser	5.51	3.42
KSH01R	61778	10 Replacement Hook Blades with Dispenser	13.24	8.21
KS05R	61784	10 Small Break-Away Blades with Dispenser	5.51	3.42
KS06R	61786	10 Large Break-Away Blades with Dispenser	7.16	4.44

Measure Stix™ Steel Measuring Tapes

- S1 Grads
- Measuring Tapes with adhesive backing
- Sticks to almost any work surface
- High quality precision steel rule is flat with permanent adhesive back
- Cut to size with scissors
- Mount on work-benches saw tables, drafting tables, etc



Cat No.	EDP	Description	List	Sale
SM412W	63170	12' x 1/2", Left-to-Right Reading	\$10.44	\$7.99
SM412WRL	64919	12' x 1/2", Right-to-Left Reading	8.94	6.99
SM44W	63168	4' x 1/2", Left-to-Right Reading	7.56	5.99
SM46WRL	66634	6' x 1/2", Right-to-Left Reading	7.05	4.99

47 Universal Bevel Protractor

- Offset and straight slots in the blade – in combination with straight slots in the stock that allow for a wide variety of adjustment and angle settings that are impossible to obtain with many ordinary levels
- 6" blade length
- Recessed clamping bolt

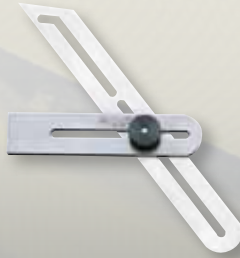

Cat No.	EDP	Description	List	Sale
47	50266	Universal Bevel	\$89.00	\$80.10

M1® All Purpose Lubricant

- Protects as it dries, avoiding dirt and grime
- Penetrates quickly to free frozen nuts and bolts
- Prevents rust and corrosion damage
- Non-soluble in water, displacing moisture to lift it away from protected surface
- Nonconductive
- Lubricates without silicone
- 12-pack of 12oz cans



Cat No.	EDP	Description	List	Sale
M1.95173	95173	Case of 12/12oz Aerosol Cans	\$98.40	\$73.80

439 Builder's Combination Tool

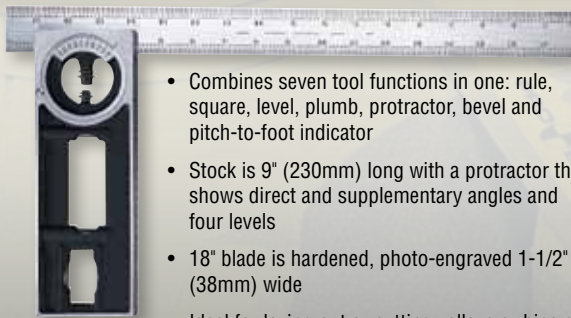

- Combines seven tool functions in one: rule, square, level, plumb, protractor, bevel and pitch-to-foot indicator
- Stock is 9" (230mm) long with a protractor that shows direct and supplementary angles and four levels
- 18" blade is hardened, photo-engraved 1-1/2" (38mm) wide
- Ideal for laying out or cutting valleys or hips of different pitches and many other jobs

Cat No.	EDP	Description	List	Sale
439-18	52110	18"	378.00	340.20

13 Double Square with Hardened Blades

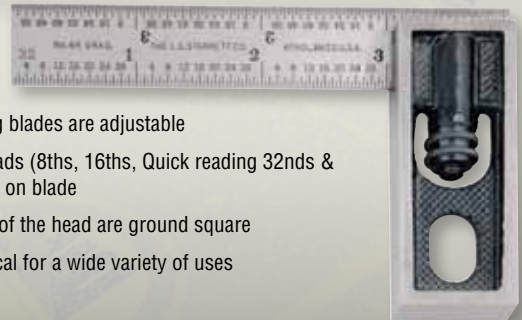

- Sliding blades are adjustable
- 4R Grads (8ths, 16ths, Quick reading 32nds & 64ths) on blade
- Faces of the head are ground square
- Practical for a wide variety of uses

Cat No.	EDP	Description	List	Sale
13A	50109	4" with Graduated Blade only	\$54.00	\$48.60

RS-24 Professional Framing Square

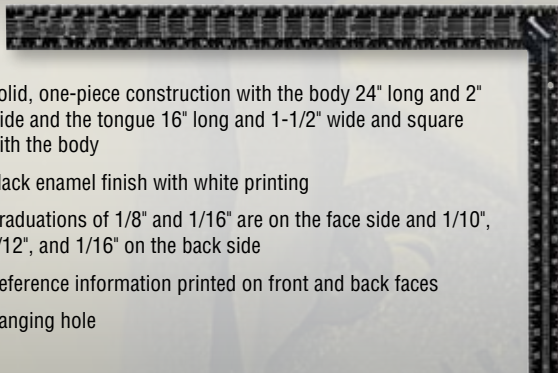

- Solid, one-piece construction with the body 24" long and 2" wide and the tongue 16" long and 1-1/2" wide and square with the body
- Black enamel finish with white printing
- Graduations of 1/8" and 1/16" are on the face side and 1/10", 1/12", and 1/16" on the back side
- Reference information printed on front and back faces
- Hanging hole

Cat No.	EDP	Description	List	Sale
RS-24	36128	24" Framing Square	\$16.77	\$15.09

Stair Gage Fixture Attachments

- 111 (long) & 470 (short) Stair Gage Fixture Attachments clamp to a framing or rafter square for laying out stair stringers, hip, valley, etc.
- Sold in left and right pairs
- Tough, rust resistant nickel plated cast iron
- Ends are machined square

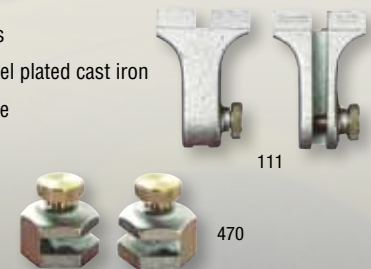

Cat No.	EDP	Description	List	Sale
111	50476	For Rafter and Framing Squares (Pair) - long	\$32.00	\$28.80
470	52482	For Rafter and Framing Squares (Pair) - short	31.00	27.90

Hand Hacksaw Frames



- K140: Closed Grip Non-adjustable light duty frame
- K145: Professional quality closed grip high-tension heavy duty with easy to use adjustment lever and sure ergonomic grip
- K153: Closed grip high-tension heavy duty constructed of cast aluminum with an extra-thick tubular steel bar for added strength, 4-3/8" throat depth and storage for spare blades
- All frames include a Starrett bi-metal unique® Blade

Cat No.	EDP	Description	List	Sale
K140	12184	Closed Grip Non-Adjustable Light Duty Hand Hacksaw Frame	\$12.80	\$7.99
K145	67818	Closed Grip High-Tension Heavy-Duty Hand Hacksaw Frame	35.00	19.99
K153	64147	Closed Grip High-Tension Heavy-Duty Hand Hacksaw Frame	35.00	19.95

bi-metal unique® HSS Safe-Flex® Hacksaw Blades

- With Starrett-exclusive bi-metal unique® providing 170% more high-speed steel weld contact area
- bi-metal unique reduces blade fracture and breakage for faster cust and longer life
- Precision ground tooth profile



Cat No.	EDP	Description	List	Sale
KBS1024-2	40334	10" x 1/2" x 0.25", 2/Card	\$3.40	\$2.49
KBS1218-2	40336	12" x 1/2" x 0.25", 2/Card	3.70	2.81
KBS1224-2	40337	12" x 1/2" x 0.25", 2/Card	3.70	2.81
KBS1232-2	40338	12" x 1/2" x 0.25", 2/Card	3.70	2.81
KBS1218-10	40342	12" x 1/2" x 0.25", 10/Pack	17.00	12.99
KBS1224-10	40343	12" x 1/2" x 0.25", 10/Pack	17.00	12.99
KBS1232-10	40344	12" x 1/2" x 0.25", 10/Pack	17.00	12.99
BS1218	40330	12" x 1/2" x 0.25", 10 Sgl. blades	1.62	1.19
BS1224	40331	12" x 1/2" x 0.25", 10 Sgl. blades	1.62	1.19
BS1232	40332	12" x 1/2" x 0.25", 10 Sgl. blades	1.62	1.19

King Cut® Fire, Rescue & Demolition Reciprocating Blade

- Tough design for fire, rescue and demolition applications
- Effectively cut through a wide variety of materials
- Bright fluorescent yellow paint and high-contrast marking system makes King Cut® blades stand out
- Starrett-exclusive bi-metal unique® construction for exceptional strength and extended blade life and fast cuts

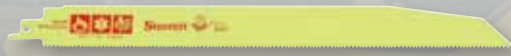

Cat No.	EDP	Blade	Size	Pack	List	Sale
BTR8610-2	11465	Tapered	8" x 1" x .063"	2/Pack	\$11.50	\$8.99
BR81014-2	11459	Straight	8" x 3/4" x .05"	2/Pack	11.50	6.99
BR81014-5	11460	Straight	8" x 3/4" x .05"	5/Pack	20.30	15.99
BR121014-20	11479	Straight	12" x 1" x .063"	20/Pack	97.30	69.99

Dual Cut® Jig Saw Blades

- Special designed teeth that cut in both directions
- Virtually eliminates burrs from both sides of the cut
- With Unified Shank® – fits all machines
- With bi-metal unique® saw technology, for faster cuts and longer blade life
- BU3DC for straight and wide arc cuts
- BU2DCS-2 for tighter curve scroll cuts

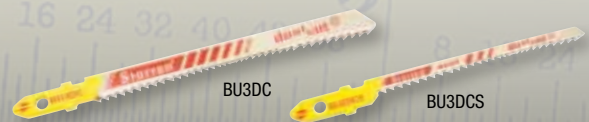

Cat No.	EDP	Description	List	Sale
BU3DC-2	12484	3" - 2/Pack	6.10	5.99
BU2DCS-2	12480	2" Scroll-Cutting - 2/Pack	5.90	5.49

Hole Saw Kits



- KV290: Electricians' & Plumbers' Kit: 9 saws, 3/4" to 2-1/2" range, A1, A2, A5 & A7 arbors, case
- KV291: Industrial Kit: 11 saws, 3/4" to 3" range, A1, A2, A5 & A7 arbors, case
- KV292: Lockset Kit: 6 saws, 7/8" to 2-1/8" range, A1, A10 & A12 arbors, case
- KV1092: Utility Kit: 6 saws, 3/4" to 2-1/2" range, A1, A2 & A12 arbors, case
- KV1094: Electrical Kit: 6 saws, 7/8" to 2-1/2" range, A1, A2 & A12 arbors, case
- KV1095: Deluxe Electricians' Kit: 10 saws, 7/8" to 4-3/4" range, A1, A2 & A4 arbors, case

Cat No.	EDP	Description	List	Sale
KV290	56011	Electricians' & Plumbers Hole Saw Kit	\$174.70	\$104.82
KV291	56012	Industrial Hole Saw Kit	196.80	118.08
KV292	56811	Lockset Hole Saw Kit	123.00	73.80
KV1092	63619	Utility Hole Saw Kit	123.00	73.80
KV1094	63620	Electrical Hole Saw Kit	135.20	81.12
KV1095	63621	Deluxe Electricians' Hole Saw Kit	233.60	140.16

Drill Gages

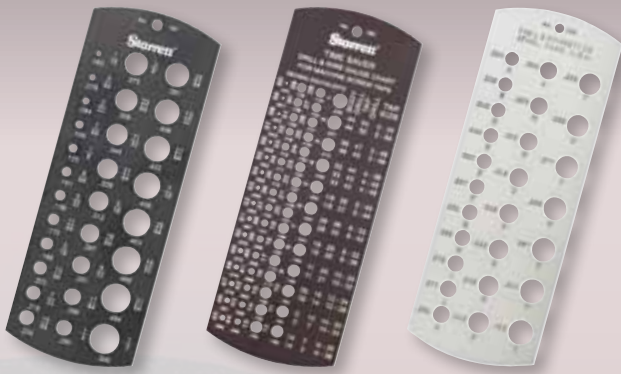

- Quick, convenient checking of drill sizes
- Approximately 5/64" thick by 2-5/16" wide by 6-1/4" long
- Rigidly tested after hardening

185 Time Saver® Tap & Drill Gage

- 60 holes with number sizes and decimal equivalents
- Tap drill sizing in "NF" National Fine or "NC" National Coarse Thread Series
- Correct amount of stock for 65% full thread
- Shows correct drill body size
- Black matte finish
- Steel stamped on one side and white marked on reverse for quick, clear reading

187 Jobbers' Drill Gage

- Quick sizing of 1/16-1/2" twist drills by 64ths
- 29 holes marked with inches and decimal equivalent drill sizes
- Black matte finish with gage information steel stamped on one side and white marked on reverse for quick, clear reading

198 Standard Letter Size Drill Gage

- Quick, convenient checking of letter size drills
- 26 holes for "A" through "Z" drill sizes and decimal equivalents .234" through .413"
- Satin finish

Cat No.	EDP	Description	List	Sale
185	50675	Time Saver® Tap & Drill Gage	\$56.00	\$50.40
187	50677	Jobbers' Drill Gage	52.00	46.80
198	50718	Standard Letter Size Drill Gage	47.00	42.30

Depth and Angle Gages

- Ground and polished hardened steel head
- Accurate, machine divided, tempered steel rule.
- Gages can be smoothly adjusted to the required measurement and then locked into position by a knurled nut
- 237 Head is made of hardened steel, ground, and nicely polished – 2-5/8" (66mm) long and 1/8" (3mm) wide



Cat No.	EDP	Description	List	Sale
236	51074	0-6" Depth and Angle Gage	\$56.00	\$50.40
237	51080	0-6" Depth Gage	43.00	38.70

827 Edge Finders

- 827A has a single end contact with a .200" diameter
- 827B has .200" and pointed contacts
- Finds work surfaces quickly and accurately
- Work with flat, straight edges, shoulders, grooves, round work, studs, dowels or center points and scribed lines
- Body and contacts are made of tool steel, hardened, ground and lapped to close tolerances for diameter and concentricity.



Cat No.	EDP	Description	List	Sale
827A	53062	Edge Finder	\$21.00	\$18.90
827B	53063	Edge Finder	24.50	22.05

91 Tap Wrenches

- Strong and well proportioned.
- Nicely finished with tempered gripping surfaces
- Firmly hold square or round shanks.
- Plunger operated by knurled sleeve – the spring inside the sleeve causes plunger to back off when pressure is removed



Cat No.	EDP	Description	List	Sale
91A	50419		39.00	35.10
91B	50420		57.00	51.30
91C	50421		92.00	82.80
91D	50422		123.00	110.70

551 Precision Screwdriver Set

- Precision-machined tips
- Vapor-chromed non-slip tips
- Hardened for maximum durability
- Tapered handles allow rapid rotation
- Spin-free finger control cap for precise turning and control



Cat No.	EDP	Description	List	Sale
S551Z-7	67203	Set of 7 Screwdrivers with Case	\$47.50	\$42.75

22C Drill Point Gage

- Quick, accurate determination of correct drill point angle of 59°
- Adjustable sliding head with locking thumb nut
- Beveled head is graduated in 32nds for measuring drill lips
- Hook rule with machine-divided graduations in 8ths, 16ths, quick-reading 32nds and 64ths
- Adjustable hook can be shortened or extended on either side of the rule or removed if desired
- Also serves as a plain rule, hook rule, depth gage and slide caliper



Cat No.	EDP	Description	List	Sale
22C	50150	Drill Point Gage	\$49.00	\$44.10

C391 Center Gage

- American Unified National Standard, 60°
- Inch graduations
- Spring-tempered steel with satinchrome finish
- Ground gaging surfaces

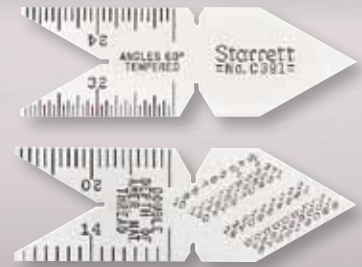

Cat No.	EDP	Description	List	Sale
C391	51475	Center Gage	\$19.50	\$17.55

Thickness Gages

- Leaves are constructed of the finest tempered steel, carefully finished to correct thickness, individually tested and marked with thickness
- Secure locking device
- Easy removal or replacement of leaves
- Rugged protective case



Cat No.	EDP	Description	List	Sale
66	50314	26 straight leaves, 1/2" x 3-1/32" leaves, Range: .0015-.025"	\$49.00	\$44.10
66T	50315	26 tapered leaves, 1/2-1/4" x 3-1/32", Range: .0015-.025"	55.00	49.50
66MA	55974	20 straight leaves, 12.7mm x 77mm leaves, Range: .05-1.0mm	49.00	44.10

Screw Pitch Gages

- Substantial steel case with folding leaves
- Locking device securely locks leaves in position
- Leaves feature a narrow design for checking internal and external threads

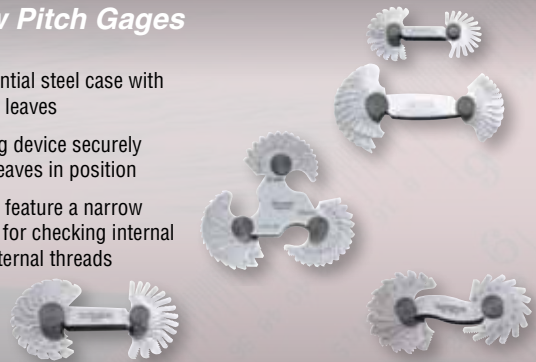

Cat No.	EDP	Leaves	TPI Range	Description	List	Sale
6	50035	30	4-42	With 11-1/2 & 27	\$33.00	\$29.70
472	52484	51	4-84	pipe thread pitches	63.00	56.70
474	52486	28	4-80		33.50	30.15
156M	50589	28	0.25-2.5mm		35.00	31.50
159M	50591	28	0.5-11.5mm	With 60° center gage	44.00	39.60

Radius Gages

178 Fillet or Radius Gages with locking device

- Lay out and check tools, dies, patterns, etc.
- Leaves for both concave and convex radii
- Nicely finished, high quality steel

167 Radius Gage Set

- Five gaging surfaces for convex or concave radii
- Satin finished stainless steel with clear radius markings



Cat No.	EDP	Description	List	Sale
178A	50664	Radius or Fillet Gage with locking device, 30 leaves, Range: 1/32 - 1/4", 64ths	\$59.00	\$53.10
178B	50666	Radius or Fillet Gage with locking device, 32 leaves, Range: 17/64 - 1/2", 64ths	65.00	58.50
S167CHZ	50619	Radius Gage Set with 4" long holder, 25 gages, Range: 1/64 - 17/64", 64ths	142.00	127.80

Telescoping Gage Sets

- Rigidly attached, automatically self-centering handle
- Constant spring tension provides uniform contact pressure
- 229 features one rigid contact arm and one spring-tensioned telescoping contact arm
- 579 has a greater range and two telescoping contacts



Cat No.	EDP	Range	Length	List	Sale
S229GZ	50929	Telescoping Gage Set, 229A/B/C/D/E, 5Pc		\$178.00	\$160.20
S579GZ	52616	Telescoping Gage Set, 579A/B/C/D, 4Pc		121.00	108.90

270 Taper Gages



- .010- .150" / 0.3-4mm
- One side graduated from .010" to .150" in thousandths of an inch;
- Reverse from 0.3mm to 4mm in 0.05mm
- Constructed of quality tool steel and accurately tapered throughout entire length
- 7/16" (11mm) wide by 6-1/4" (160mm) long
- Can be used as a precision shim

Cat No.	EDP	Description	List	Sale
270	51292	Range: .010-.150", 7/16" wide, 6-1/4" long	\$94.00	\$84.60

269A Taper Gages

- These gages are for determining hole sizes in dies and all kinds of other work
- Fast and accurate hole sizing
- Graduated in thousandths of an inch
- Tempered steel construction with locking device
- Range of .100-.500" read in thousandths
- 2-1/2" length
- 8 Leaves

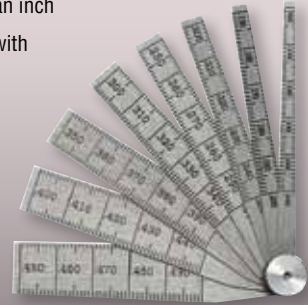

Cat No.	EDP	Description	List	Sale
269A	51290	Range: .100-.500", Length: 2-1/2", 8 leaves	114.00	102.60

829 Small Hole Gages

- Well balanced full-ball gages
- Ideal for measuring small holes, slots, grooves and recesses
- Hardened measuring surface with two-point contact
- Smooth, sensitive adjustment for improved accuracy
- Safety stop prevents breakage



Cat No.	EDP	Range	Length	List	Sale
829A	53070	.125-.200" (3.2-5.1mm)	2-7/8" (75mm)	\$28.00	\$25.20
829B	53071	.200-.300" (5.1-7.6mm)	3" (80mm)	28.50	25.65
829C	53072	.300-.400" (7.6-10.2mm)	3-3/8" (85mm)	28.50	25.65
829D	53073	.400-.500" (10.2-12.7mm)	3-1/2" (90mm)	29.50	26.55
S829EZ	53074	Set of all 4 in Case		121.00	108.90

Thickness Gage/"Feeler Stock"

- 12" long by 1/2" wide
- .001" through .030" thick
- Made of the finest tempered steel
- Rounded edges for ease of use
- Marked every 6" with thickness
- Convenient 3/16" hole for hanging



Cat No.	EDP	Description	List	Sale
S667A	63274	One each, 32 sizes	\$64.00	\$51.48

190 Little Giant Jack Screw Set

- Very handy for leveling work on planer beds, upright drills, setting up machinery, and for general use in the toolroom or machine shop.



Cat No.	EDP	Description	List	Sale
S190	50680	Little Giant Jack Screw Set	\$49.00	\$44.10

200W Wooden Tool Chest

- Light and strong solid poplar with finger lock joint construction
- 9" W x 14-1/2" D x 12-1/2" H
- Two key lockable drawers with commercial grade slides
- Generous top storage area with close and latch lid
- Green felt lining in top section and drawer bottoms
- Brass trim and support



Cat No.	EDP	Description	List	Sale
200W	55208	Wooden Tool Chest	\$591.00	\$531.90

3811 Portable Hardness Tester

- High accuracy, simple to operate, battery operated with a wide measuring range
- Compact size: 2-1/2" W x 1-1/8" D x 6-1/2" L (64 x 29 x 165mm)
- Built-in D impact probe with internal tungsten carbide test tip
- Back lighting, with LCD readout
- Measuring Accuracy $\pm 0.8\%$ (corresponding to ± 1 HRC @ HRC=58)
- Archives data with extended memory to 500 groups
- Includes case with calibrated test block



Cat No.	EDP	Description	List	Sale
3811	67184	Portable Hardness Tester	\$2,504.00	\$2,003.20

3805A Electronic Durometer

- Ergonomically designed, lightweight and accurate
- Measures hardness in Shore A values
- Includes RBR-63 rubber test block (Shore A 61-63)
- Contact is made with a 35° blunt point for accuracy
- Large, easy-to-read LCD display and Auto-Off
- Ability to allow averaging and to lock in peak value
- Repetitive deviation of 20-90 HA ± 1 grade
- Resolution of .1HA
- Measuring range of 0-100HA
- Conforms to ASTM D-2240, ISO 7619 standards



Cat No.	EDP	Description	List	Sale
3805A	12265	Electronic Durometer	\$699.00	\$559.20

3800 Portable Surface Roughness Tester

- Measures surface texture conforming to traceable standards
- Convenient, pocket-sized and easy to use
- LCD display
- Measures Ra or Rz
- Battery powered or line cord
- Adjustable cutoff values
- Diamond tracer tip
- Includes case, charger, and roughness standard



Cat No.	EDP	Description	List	Sale
3800	67182	Portable Surface Roughness Tester	\$1,651.00	\$1,320.80

KineScope

- A digital video camera, with precision optics and LED lighting that fits in the palm of your hand
- 40-140X magnification to zoom in on the fine details
- Capture images or video and easily add labels, make measurements, and draw on the live image.
- Connects to your computer's USB port
- Includes VLink imaging software.
- Image Sensor: 1/4" CMOS
- Resolution: 4 microns
- Pixel Resolution: 640 x 480
- Field of View at
40X = 7.5 x 10mm,
140X = 1.8 x 2.5mm



Cat No.	EDP	Description	List	Sale
KineScope		Digital Video Camera	\$875.00	\$831.25

3814 Analog Bench Hardness Tester

- Reliable bench hardness tester provides Rockwell Hardness values on all types of materials
- Ability to handle Rockwell Scales A through H and K
- High quality casting and ergonomic design
- Conforms to ASTM E-18 standard
- Includes a diamond indenter, a 1/16" (1.6mm) ball indenter, three certified test blocks, four test tables, spot anvil and a standard vee anvil
- Economically priced



Cat No.	EDP	Description	List	Sale
3814	67754		2,389.00	2,269.55

660 Magnetic Base Indicator Holder

- Triple jointed arm -- three adjustable pivots controlled by a single knob for fast, easy indicator positioning -- full 360° horizontal and over 180° vertical
- Small but powerful magnetic base with 70 lb (320N) holding force
- Positive On/Off switch and sensitive fine-adjustment thumb screw
- Base Dimensions: 1-3/16" x 1-9/16" x 1-3/8" (30mm x 40mm x 35mm)
- Will hold any indicator with a 3/8" (9.5mm) stem or standard dovetail mount
- Maximum Horizontal Reach: 4 7/8" (120mm); Maximum Vertical Reach: 7 5/8" (190mm)



Cat No.	EDP	Description	List	Sale
660	68621	Magnetic Base	\$109.00	\$92.65

661 Mini Magnetic Indicator Holder

- Simple, versatile, effective and economical tool for a variety of indicator holding tasks
- No levers or switches – simply place the holder on the measuring surface, attach the indicator and position as required
- 30 lb (133 N) of holding force
- Holds indicators with 3/8" stems or standard dovetail mounts
- Fits over spindles and posts with diameter of 1/4" (6.3mm)
- Includes an 8mm adapter for indicators with (8mm) metric stems
- Base Diameter: 1.180" (30mm), Base Height: 1" (25.4mm), Overall Height 4.173" (106mm)

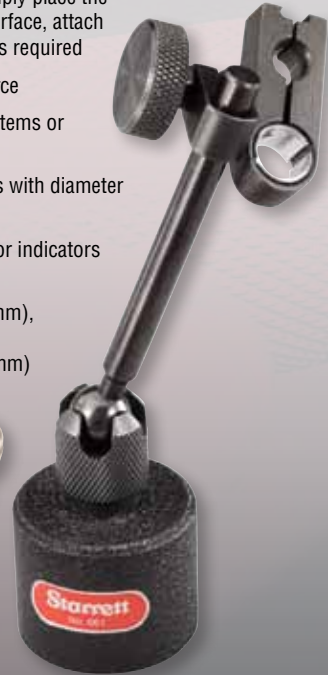

Cat No.	EDP	Description	List	Sale
661	68620	Mini Magnetic Indicator Holder	\$52.00	\$44.20

Precision



Measurements matter.
Be sure. Choose Starrett.

Starrett[®]

Solutions

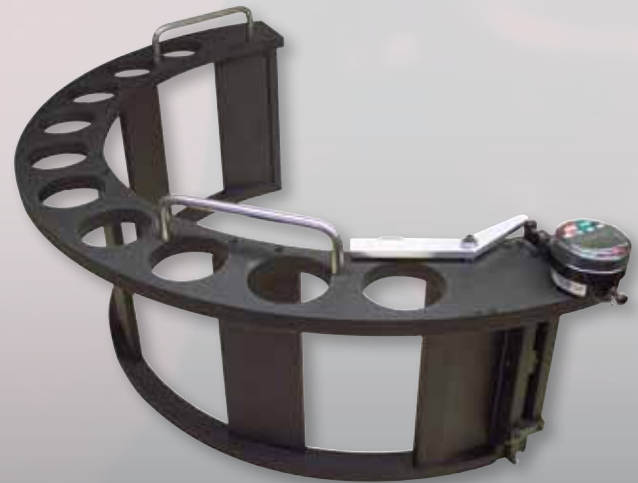

Special Application.
Custom Solution.



*Hacksaw Blades & Frames
See Page C4*



*3753 Depth Gages
See Page 9*



*Master Pro Hardwood Levels
See Page C2*



*818 Center Punch
See Page 10*

Promotion 10.3

*Prices in U.S. Dollars
Sale Valid September 1 - December 31, 2010
Specifications subject to change*

*Promotion 10.3D 08/10
© The L.S. Starrett Company*