

Plastic encased safety interlocking switch

Type **PSEN me2/PSEN me3**

Intended use

The plastic encased safety switches PSEN me2 and PSEN me3 with separate actuator are suitable for the mounting on safety guards. They are designated to trigger switching operations in control circuits.

Function

If the safety guard is opened the contact(s) with forced disconnection \ominus will break the safety control circuit (safety contacts get opened).



Safety instructions



Improper installation or manipulation of the safety switch renders the personal protection function useless and can cause serious injury or accidental death.

In order to maintain the maximum level of safety, always order and use actuators together with the correct safety switches.

Dimensions [mm]

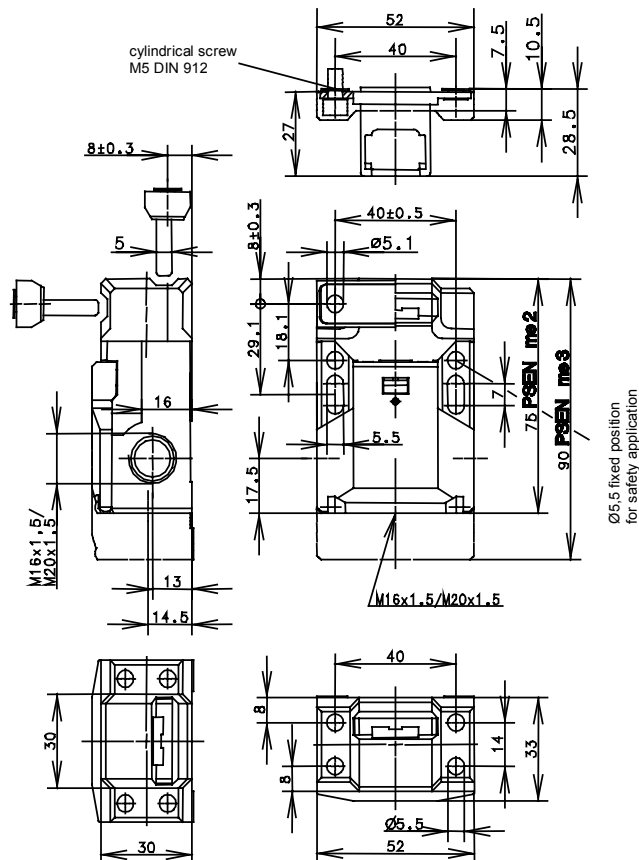

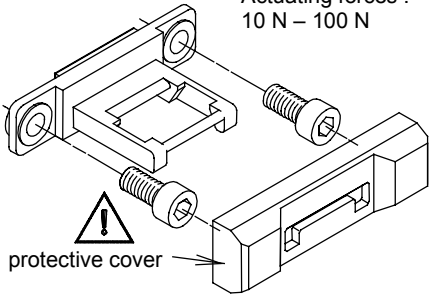
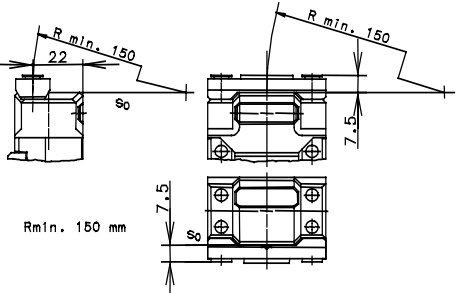
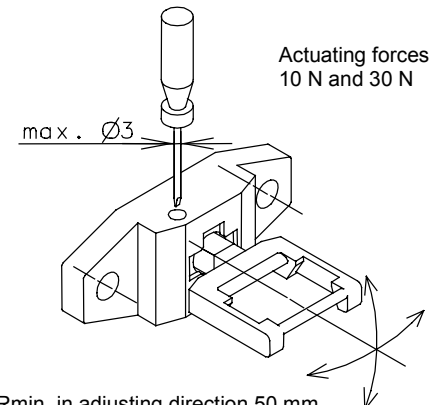
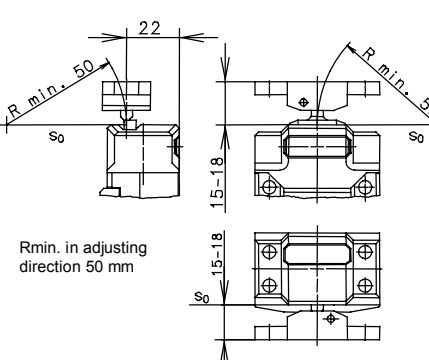
Actuator	
<p style="text-align: center;">PSEN me2AS</p> <p style="text-align: center;">Actuating forces : 10 N – 100 N</p>  <p style="text-align: center;">protective cover</p> <p>The protective cover must be latched onto the actuator after mounting. The protective cover prevents the actuator from being easily dismantled and also provides protection against overtravel of the actuator in case of not proper installed mechanical end stops for the guard.</p>  <p style="text-align: center;">Minimum radii reference to a point of rotation on enclosure top edge S_0</p>	<p style="text-align: center;">PSEN me2AR</p> <p style="text-align: center;">Actuating forces : 10 N and 30 N</p>  <p style="text-align: center;">max. $\varnothing 3$</p> <p style="text-align: center;">Rmin. in adjusting direction 50 mm</p>  <p style="text-align: center;">Rmin. in adjusting direction 50 mm</p> <p style="text-align: center;">Minimum radii reference to a point of rotation on enclosure top edge S_0</p>
<p>Mounting dimension for all actuators: 40 mm with M5- screws acc. DIN 912!</p>	

Installation

 Installation by trained and qualified personnel only!

To mount the switch gear 2 screws M5 shall be used.

Actuator PSEN me2AS and PSEN me2AR:

The user shall make sure that the actuator is form-fit mounted. The actuator mounting should not be solvable with simple tools. The mounting requires 2 screws M5 acc. DIN 912.

The switch and the actuator shall be aligned during installation in such a way that the maximum permitted misalignment with closed safety guard, which is stated in the drawing, will not be exceeded. The actuator PSEN me2AR has to be adjusted in such a way that the actuator can be inserted into the switch head without significant lateral forces.

The mounting position is any desired but shall support inspection and replacement if necessary by qualified personnel. Choose such a mounting position that no foreign parts seep into the opening of the actuating device. The rated degree of protection (IP-Code) of the switch applies only with closed cover lid and when an at least evenly matched cable gland with adequate cable is used.

The switches shall not be used as mechanical end stops.

The safety switch shall not be used as mechanical end stop!

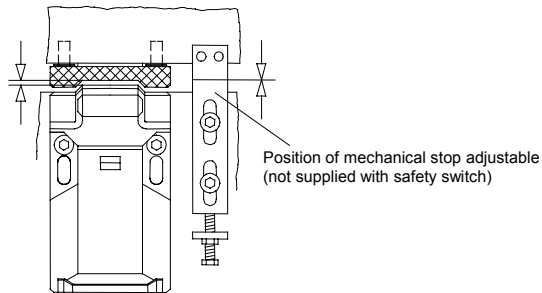

4 different directions of actuation by turning the cap in position A or B:

1. remove the actuator
2. open cover lid
3. snap of cap
4. remove cap
5. turn cap
6. latch cap
7. for fixing the cap close cover lid

Actuating forces (Extraction force):

Standard = 10 N

PSEN me3.02 = 30 N

PSEN me2.1, PSEN me3.01, PSEN me3.11,
PSEN me3.21 = 100 N

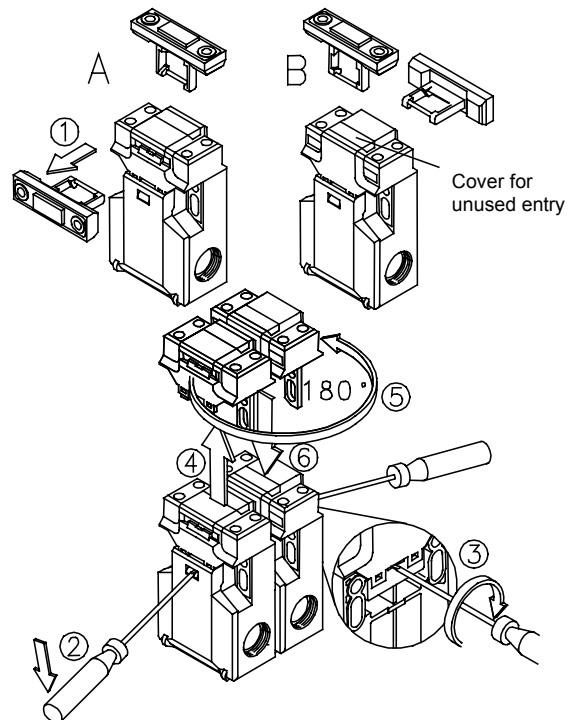
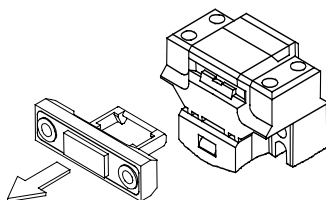

Mounting M20/M16 cable gland/cable:

Connection type:
2 or 4 screw connectors M3,5 or
6 screw connectors M3
Conductor cross section:
single core 0,5-1,5 mm²/litz wire with
connector sleeve 0,5-1,5 mm²

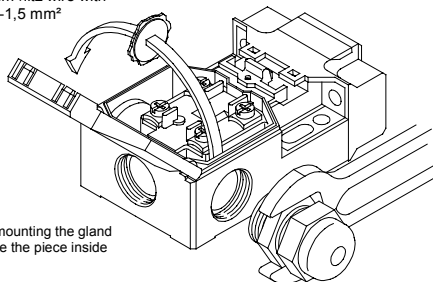

Electrical connection



The electrical connection shall only be carried out by trained and qualified personnel!

The electrical contacts of the switches **PSEN me2** and **PSEN me2.1** feature 2 screw terminals M3,5.
Tightening torque $M = 0,8 \text{ Nm}$.

The electrical contacts of the switches **PSEN me3**, **PSEN me3.01**, **PSEN me3.02**, **PSEN me3.1** and **PSEN me3.11** feature 4 screw terminals M3,5.
Tightening torque $M = 0,8 \text{ Nm}$.

The electrical contacts of the switches **PSEN me3.2** and **PSEN me3.21** feature 6 screw terminals M3.
Tightening torque $M = 0,6 \text{ Nm}$.

The connection requires a stranded wire with ferrule or a solid wire with a cross section of $0,5 - 1,5 \text{ mm}^2$.
For safety circuits acc. EN 60204 use the normally closed contact(s) (N.C.) only.

Installation and Operating Instructions

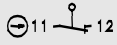
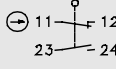
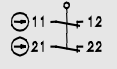
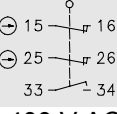
Electrical data		PSEN me2 PSEN me2.1	PSEN me3 PSEN me3.01 PSEN me3.02	PSEN me3.1 PSEN me3.11	PSEN me3.2 PSEN me3.21
Switching function		1 NC (Y)	1 NO/1 NC (Zb)	2 NC (Zb)	1 NO/2 NC (Zb)
Switch symbol					
Rated insulation voltage	U_i	250 V AC	250 V AC	250 V AC	400 V AC
Conventional thermal current	I_{the}	5 A	10 A	10 A	5 A
Utilization category acc. IEC/EN 60947-5-1		AC-15, U_e/I_e 240 V/1,5 A	AC-15, U_e/I_e 240 V/3 A	AC-15, U_e/I_e 240 V/3 A	AC-15, U_e/I_e 240 V/1,5 A
Type of short-circuit protection		6 A gL/gG	10 A gL/gG	6 A gL/gG	6 A gL/gG
Forced disconnection (N.C.)	\ominus	Melting fuse acc. IEC/EN 60947-5-1, annex K IEC/EN 60947-5-1			
Degree of protection		II, protective insulation			

Mechanical data	
Enclosure	Thermoplastic, glass fiber reinforced (UL94-V0)
Cover	Thermoplastic, glass fiber reinforced (UL94-V0)
Ambient air temperature	-30°C to +80°C, -22°F to +176°F
Cable entry	PSEN me2, PSEN me2.1 3 x M16x1,5 PSEN me3, PSEN me3.01, PSEN me3.02 3 x M20x1,5 PSEN me3.1, PSEN me3.11 3 x M20x1,5 PSEN me3.2, PSEN me3.21 2 x M20x1,5
Protection class	IP65 acc. EN 60529; DIN VDE 0470 T1
Weight	PSEN me2 ≈ 0,1 kg PSEN me3 ≈ 0,13 kg

Actuating device	
Actuator	Separate actuator (St stainless)
Actuating radius	2AS ≥ 150 mm 2AR ≥ 50 mm
Actuating speed	≤ 0,2 m/s
Extraction force	Standard 10N PSEN me3.02 30N PSEN me2.1, PSEN me3.01, PSEN me3.11, PSEN me3.21 100N
Mechanical life	1 x 10 ⁶ switching cycles 1 x 10 ⁵ switching cycles (extended actuation force)
Switching frequency	≤ 30/minute

Standards	
	VDE 0660 T100, DIN EN 60947-1, IEC 60947-1
	VDE 0660 T200, DIN EN 60947-5-1, IEC 60947-5-1
	GS-ET-15

EU-Conformity	
	CE

Approvals	
	BG (applied for)
	UL/CSA A300 applied for PSEN me3, PSEN me3.01, PSEN me3.02, PSEN me3.1, PSEN me3.11
	UL/CSA B300 applied for PSEN me2, PSEN me2.1, PSEN me3.2, PSEN me3.21

Start-up

Mechanical function test:

Actuate the safety guard und check the proper switching function.

Electrical function test in the safety control circuit:

- Opening the safety guard shall break off the energy of the drive.
- The drive shall only be energized when the safety guard is in its closed position.

Maintenance / Inspection

The switching device is maintenance-free. For trouble-free operation and a long service life the device should be inspected regularly. Ensure that:

- all components are secure and tight
- switching functions operate properly
- all sealing gaskets are in proper condition
- the components show no signs of tear and wear.

If defects are detected the complete switching device and the actuator have to be replaced.

Liability disclaimer

By breach of the given instructions (concerning the intended use, the safety instructions, the installation and connection through qualified personnel and the testing of the safety function) any liability expires.

Installation and Operating Instructions

