

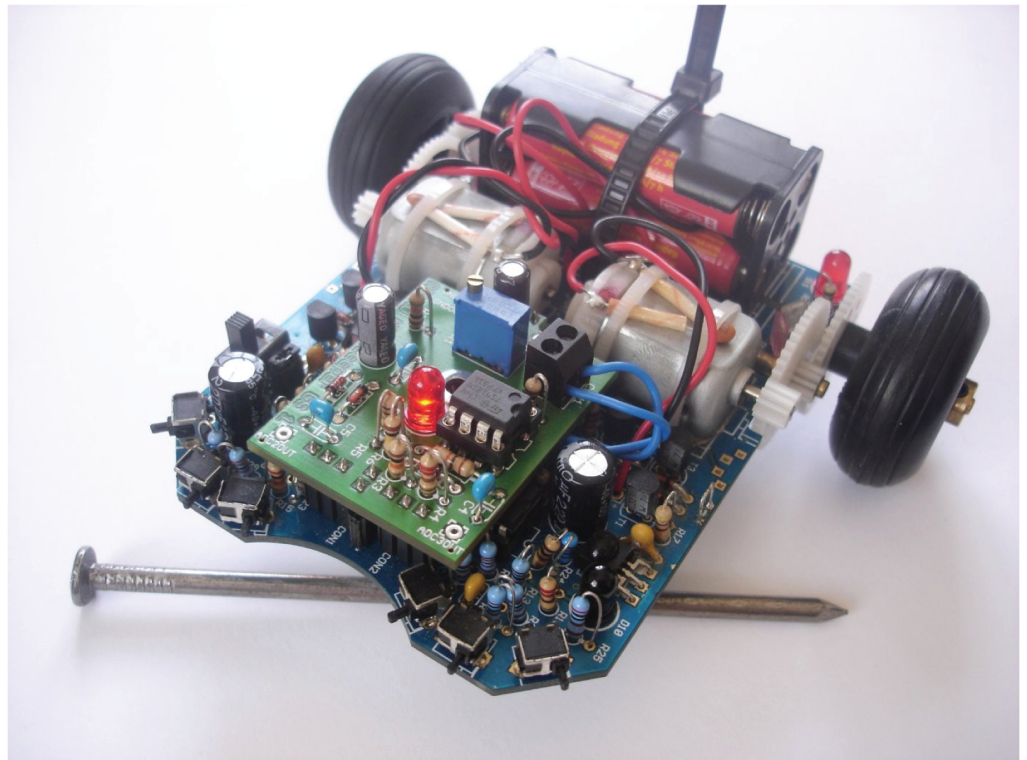

Global Specialties®

ARX-MSP

Minesweeper Kit



globalspecialties.com

1-800-572-1028

22820 Savi Ranch Parkway Yorba Linda, CA 92887

©2013 Global Specialties

1 Basic description of the design

The minesweeper extension will enable the ASURO robot to detect metallic objects underneath the halved Ping-pong ball-glider. This will allow you – of course within the scope of the robot's and the kit's possibilities - to develop the scenario of a robotic mine detector respectively treasury hunter or a simplified version of a detector and tracer for cables, reinforcing bars and I-beams.

To avoid abundant explanations for the physical theories for magnetic fields and complex AC-currents, the following chapters strictly document the basic description of the design and the user's manual.

An operational amplifier (Opamp) has been applied to stimulate oscillations in the resonant circuit consisting of a capacitor (C) and an inductor (L) applying an open pot core. Application of the magnetically open pot core allows the magnetic field to expand into the surrounding free field and to be influenced by neighbouring metallic objects.

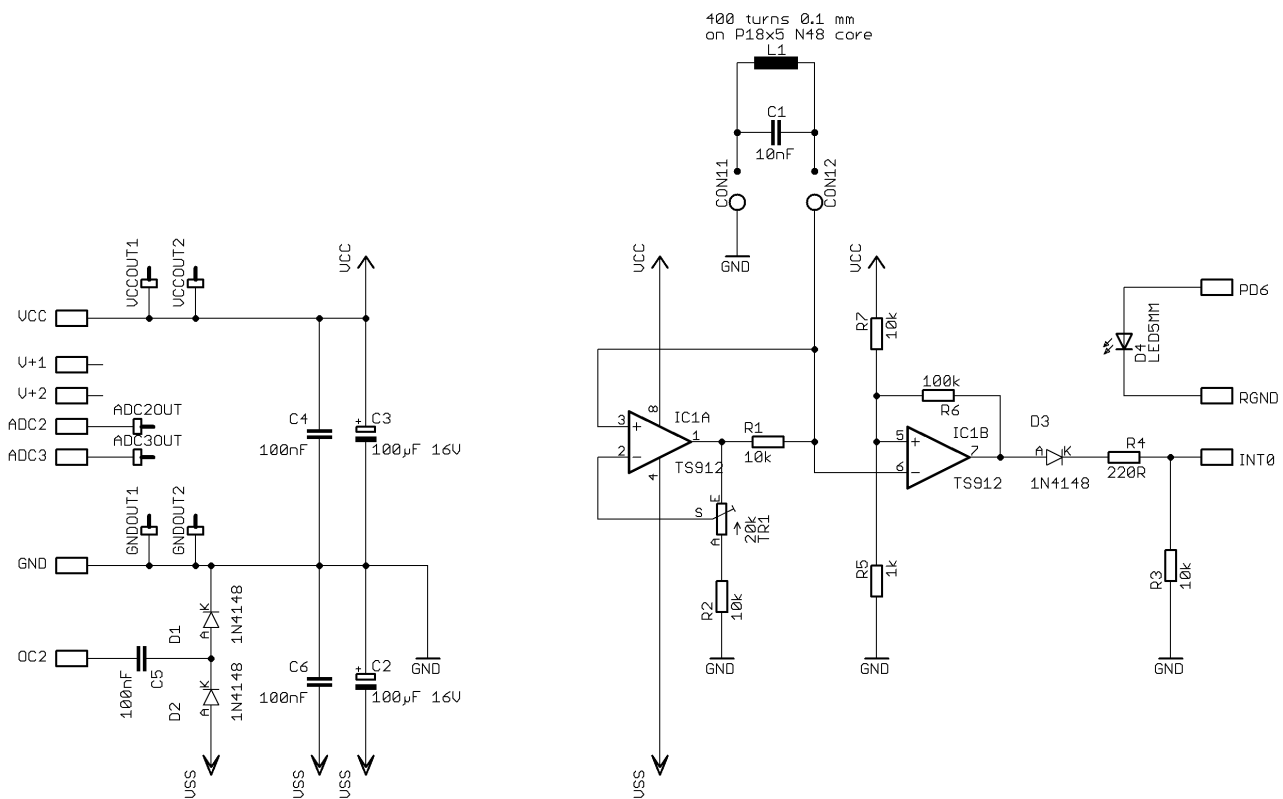

Figure 1: Schematics for the "Minesweeper"-Extension

Fig. 1 displays the schematic diagram. The resonant circuit consists of inductance L1 and capacitor C1. The design allows resonant behaviour by cyclically exchanging the capacitor's electric field energy and the inductor's magnetic field energy. The design's transfer frequency depends on the values for the capacitor and for the inductor. Assuming negligible losses, the resonator's frequency may be calculated by the following formula:

$$f_0 = \frac{1}{2\pi\sqrt{LC}}$$

Exchanging the capacitor's electric field energy and the inductor's magnetic field energy cannot be performed without losses and the losses will cause the oscillation to decay within a few cycles. We continually have to feed energy into the system to compensate losses. In analogy to a children's swing, the system will have to apply the correct phase in feeding the energy into the circuit.

To achieve this goal, the design controls the capacitor's current proportionally to the capacitor's voltage.

In this system the active element is the operational amplifier IC1A in a non-inverting amplifier circuit with resistor R2 and the trimmer resistor TR1. This circuit will amplify the capacitor's voltage at an adjustable rate of 1 up to 3, which will increase the current into resistor R1 proportionally to the voltage at C1. The losses in the resonator circuit may vary and to compensate a range of tolerances, we will need an adjustable amplifier.

The operational amplifier IC1B is used as a comparator and compares the resonator's voltage with a reference voltage of approx. 0.5V (depending on ASURO's battery voltage). The comparator's result is applied to the extension pin INT1. To avoid signal collisions between the processor pin and the output of the operational amplifier in a non-programmed processor, the port is being protected by resistor R4. D4 replaces the previous line follower LED.

The left part of the circuit, containing a number of diodes and capacitors, generates a negative voltage with respect to the ground level. The design will need a negative voltage as the resonator's voltage swings in a positive and negative range, centred at the ground level.

Several types of designs are available for metal detectors. The ASURO design supports the following two design types:

1. The design's amplification factor and the equivalent energy input for the resonator is to be controlled at a level, in which electrical losses in the resonator are exactly to be compensated as long as no metal is to be located near the coil. If metal objects are located near the coil, the so-called *eddy currents* (for conducting materials) or *demagnetizing losses* (for non-conducting, but ferromagnetic materials) result in extra losses, which will cause the decay of oscillations.
2. The design's amplification factor is to be controlled at a level, at which additional losses by metals in the vicinity of the coil will be compensated and the circuit is to measure the oscillator's frequency. In this mode any conducting materials near the coil result in eddy currents, decreasing the field strength and the inductance and simultaneously raising the oscillator's frequency. Ferromagnetic materials will increase the field strength and the inductance, which will lower the oscillator's frequency. Additionally to detecting metals, this design mode also allows a rather crude determination of the type of detected metal.

2 *Constructional details*

2.1 **Manufacturing the coil**

In case the coil has been prefabricated completely, including glueing the capacitor and applying the cables as documented in fig. 8, you may skip this chapter. Otherwise you will enjoy the next steps!

First of all, we must apply 400 windings (yes, you are reading this correctly!) of very thin isolated copper-wire (diameter 0.1mm) to a coil-carrier.

The kit supplies a double-sided coil-carrier for two core-halves (see fig. 2).



Figure 2: coil-carrier, complete



Figure 3: coil-carrier, halved

In order to fit for our purposes, we will have to split up the carrier with a saw. A suitable saw for this is a fine-tooth hacksaw. We will have to remove one chamber by sawing the other chamber in the middle. This procedure results in a singular coil-carrier. Remaining sawing edges can be removed with fine sandpaper (grain size: 240 or 300) or by carefully using a sharp knife (protect your fingers!). The removed parts will not be needed and can be thrown away.

In order to apply the coil to the carrier, we suggest to place the carrier to a pencil-shaft or (even better for it's conical form) to a suitable paintbrush. In an optimal method we also carefully fix a few centimetres of the isolated copper wire together with the carrier at the pencil's shaft as demonstrated in fig. 4. As an extra fixation you may use some adhesive tape (cello tape) to avoid slipping movements of the wire.



Figure 4: Winding preparations

After these preparations, you carefully start winding up the 400 turns of wire. Of course you avoid reversing the winding direction and you fill the windings neatly, otherwise the 400 windings of wire will fail to fit in the available place. In case the wire should break (there is no room for a repair) or you fail to count correctly, you must restart the procedure. No problems are to be expected for winding numbers between 380 up to 420, but do not exceed these tolerances.

Having completed the windings you are advised to fix the windings with some *nail varnish* or *instant glue*. As soon as the glue has hardened you may carefully remove the cello tape and the pencil or brush.

You may also cut the wire, but do not forget to reserve a few centimetres at both sides. The wire-endings have to be directed into one direction and are not allowed to pass through the hole in the coil-carrier (see fig. 5).



Fig. 5: coil-carrier - completed

Having completed the coil-carrier, you can fix the structure into the core with some *instant glue*. The wire's endings are to leave the core at the closed core-side through a slit (see fig. 6).

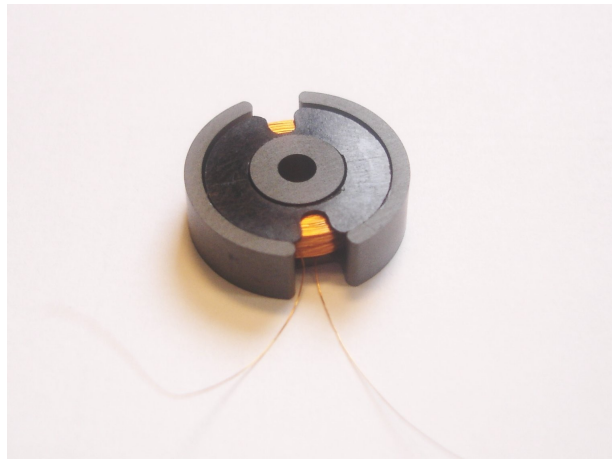

Fig. 6: Coil - fixed in the core

At this stage you have to remove the isolation at the wire-endings, starting at one or two millimetres from the core towards the outside. The optimal tool to remove isolation is a soldering tool with some fresh solder at the soldering tip. Apply the heated top for some time until the isolation has been removed and a thin layer of soldering tin is covering the wire. Warning: the generated smoke may cause damage to your health and should not be inhaled!

At last you put some instant glue to the backside of the coil and fix the 10nF-capacitor (imprinted text: 103) in a suitable position to point the wiring connections towards the slit for the coil-windings. Fig. 7 demonstrates a location for the capacitor besides the carrier's hole – just in case we may need the hole for some other purpose. The published design however does not really require this exact position.

Now cut the capacitor's wiring connections to approx. 5 mm, wind the tinned copper wire-endings around these wiring connections (maybe using a pair of tweezers) and fix the connection by soldering.

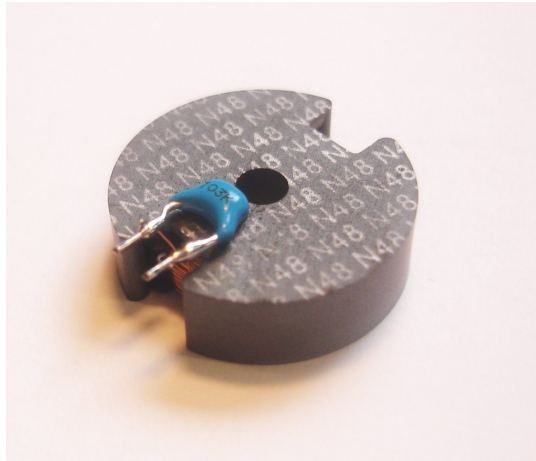

Fig. 7: Coil with capacitor

Next, we proceed with the ready-made cables. The dual cable has been dimensioned at 70 mm, stripped, twined and tinned at the cable-endings. Solder the cable-endings directly entwined to the capacitor-endings with the endings and pointing in the same direction as shown in fig. 8. Polarity is irrelevant. If you have a multimeter you may now measure the resistance between both cable-endings. The resistance-value is to be approx. 30Ω . If the value exceeds 60Ω you should check the proper removal of the isolation layer at the thin copper wires, the soldering quality and any ruptures of the soldering and cables. Should the resistance-value be much lower ($< 10\Omega$), you must check for short circuits at or near the soldering area. Unfortunately you are unable to detect short circuits within the winding area.

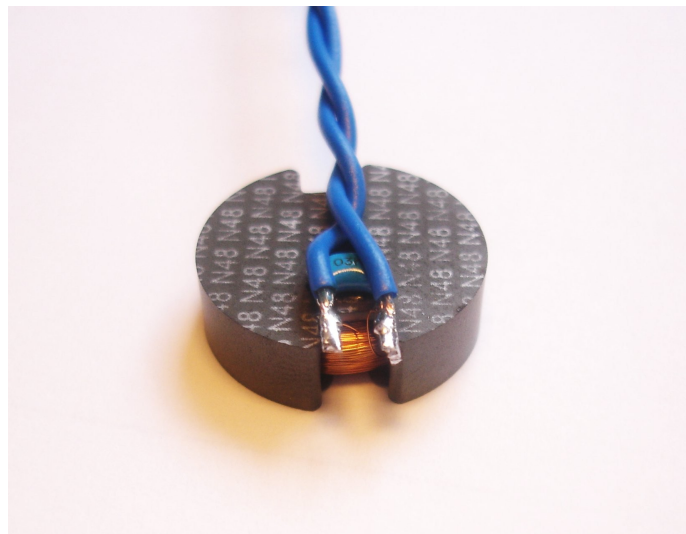

Fig. 8: Coil (assembly completed)

2.2 Inserting the coil assembly

To insert the completed coil assembly into the robot, you start by removing the ping-pong ball. Right now you will be grateful if you have glued the ping-pong ball at a minimal number of points instead of an overall glued area of the component.

Proceed by glueing – again using an *instant glue* – the coil at the backside under the ping-pong ball (see fig. 9).

Attention: If ASURO has not been prepared for assembling an extension PC-board, you will have to postpone attaching the ping-pong ball until the preparation for the extension board has been completed.

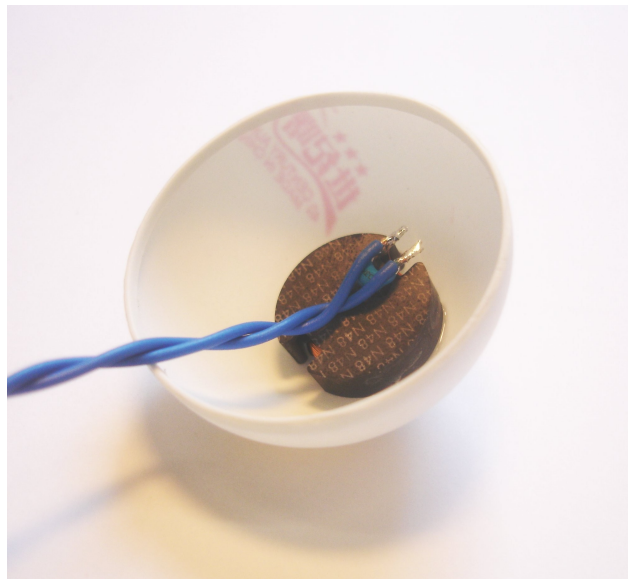

Fig. 9: Coil - attached to the ping-pong ball

2.3 Inserting the extended plug sockets

Before assembling the components to the PC-board you will have to insert the extended plug sockets. You will have to use a different procedure depending on the status of the ASURO-system. Please check whether the ASURO has been prepared for assembling an extension PC-board or not.

a) ASURO does not provide extended plug sockets for the extension board

In this case you will have to remove the components for the line-tracing (the photo-transistors T9 and T10, as well as the LED D11) from the PC-board. These activities require a removal of the *ping-pong ball*. The easiest way to proceed is to heat the components, which are to be removed with a soldering device while simultaneously and carefully pulling the components out of the PC-board's holes. If you are lucky the PCB-holes are free, otherwise the superfluous solder may carefully be removed with a solder sucker and / or a solder wick.

Now the two- and three-poled male and female plug elements have to be assembled and – additionally to the plugs at the ASURO-board – inserted in the ASURO-PCB as illustrated in fig. 10. In a following step you *first* insert the extension board and *at last* solder the male and female plug elements at the extension-board and the ASURO-main PC-board.

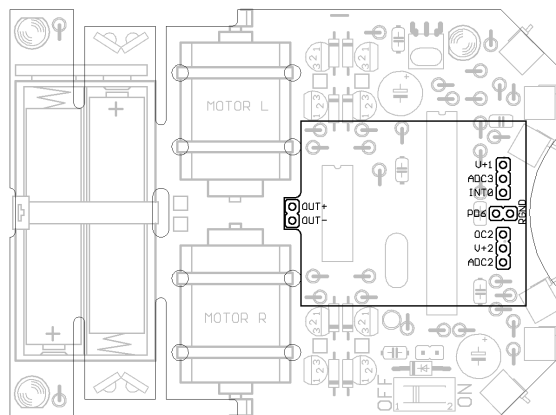

Fig. 10: Inserting the Extension-PCB

b) ASURO already provides extended plug sockets for the extension board

The two- and three-poled plug elements are to be inserted into the plugs at the ASURO-PC-board (see fig. 10), on top of which you attach the extension board. The pins will be protruding from the PCB. If all components are well-placed, the extended plug sockets are to be soldered to the extension board.

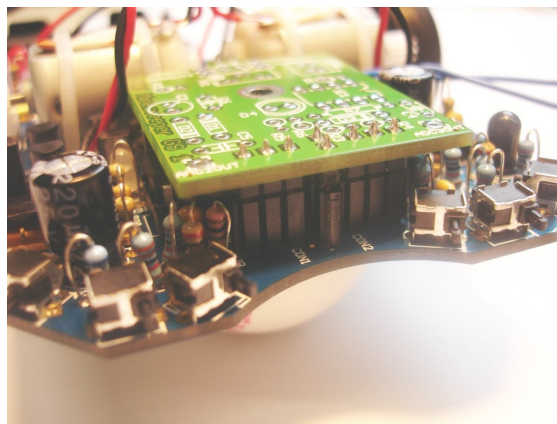

Fig. 11: Extension board with extended plug sockets

2.4 Placing the ping-pong ball

Having soldered the extended plug-sockets to the printed circuit board, you have to unplug the extension board and place the component apart for further assembling activities. Now pull the connecting cable of the coil through the hole in the ASURO-PCB and attach the ping-pong ball (together with the included coil) carefully with merely three or four glueing dots at the ASURO-PCB.

2.5 Assembling the Printed Circuit Board

After placement of the extended plug sockets (and eventually the plug arrays as well), you may remove the PCB and complete the assembly phase. According to the component placement drawing (see fig. 12) you are advised to proceed the following way: Up to R7 all resistors are to be placed upright – according to the ASURO-standard, which implies bending a U-turn (180°) for one leg of the components. Bend both legs for component R7 at an angle of 90°.

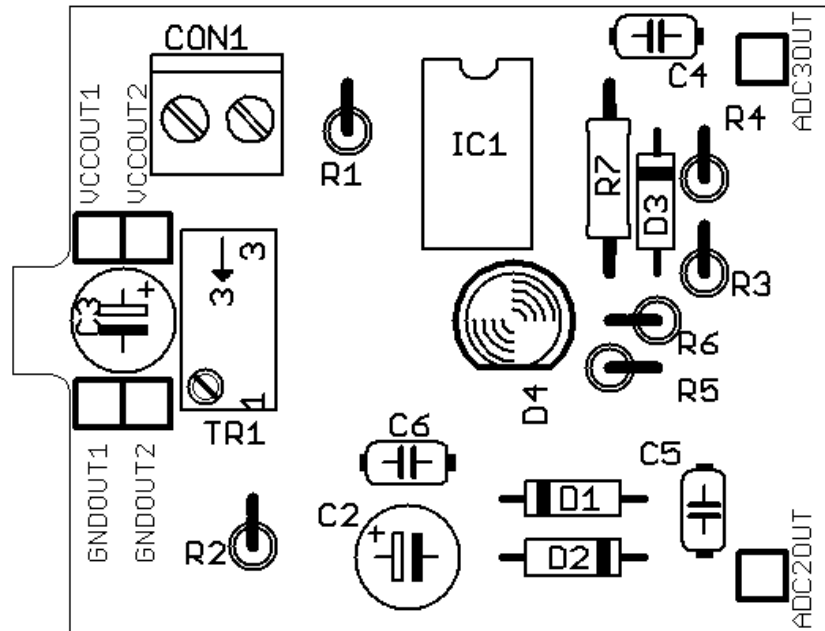

Fig. 12: Component placement drawing

Please insert the components in the following sequence:

IC1: Initially merely insert the socket, be careful to apply the correct polarity!

D1, D2, D3: 1N4148, be careful to apply the correct polarity!

C4, C5, C6: 100nF ceramic

R1, R2, R3, R7: 10k Ω 5% (brown, black, orange, gold)

R4: 220 Ω 5% (red, red, brown, gold)

R5: 1k Ω 5% (brown, black, red, gold)

R6: 100k Ω 5% (brown, black, yellow, gold)

C2, C3: Electrolytic capacitor 100 μ F, minimal 16V, be careful to apply the correct polarity!

TR1: Spindle-trimmer 20k upright

D4: LED 5mm rot, be careful to apply the correct polarity!

CON1: screw terminal, cable entry must point to the PCB-edge.

IC1: Now insert the TS912 into the socket. Maybe you will have to bend the legs slightly. Be careful to apply the correct polarity: the marker at the component must be oriented to the corresponding marker at the socket!

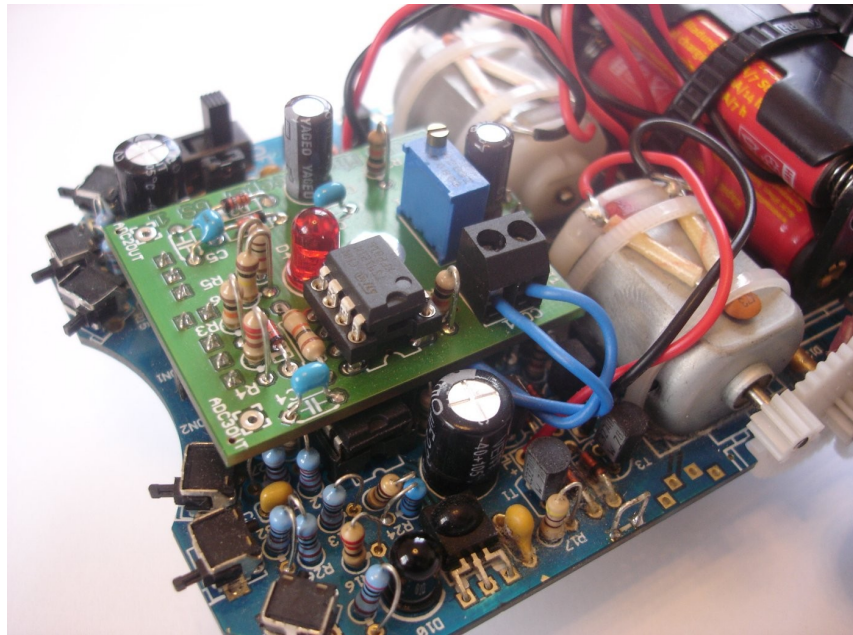

Fig. 13: Completed and placed Extension Board

Note: Initially the terminals VCCOUT1/2, GNDOUT1/2 and ADC2OUT/ADC3OUT will not be needed. Additionally to the fixing hole at the PCB, these terminals may later be used to connect two distance sensors in a triangulation-sensor-system. This will allow the ASURO to apply an autonomous navigation system and to be searching metallic objects as well.

For more details please consult “More Fun with ASURO, Volume II”. Instead of attaching the triangulation-sensors directly to the ASURO-PCB, you will now have to attach these to the extension board.

2.6 Startup procedure

Having attached the ping-pong ball including the coil and having completed the PCB-assembly, you can now insert the PCB into the (deactivated!) robot. Please check the isolation of the components carefully: none of the components at the ASURO-PCB are to short-circuit the metallic areas of the extension board. The coil cabling is to be guided from below the PCB to the side of the screw terminal CON1 and may now be attached to the screw terminal. In this case the polarity may be neglected.

In order to view the oscillations in the resonator circuit, you enter the following program (MinesweeperTest1):

```
#include "asuro.h"

extern volatile unsigned char count72kHz;

int main(void)
{
    unsigned char oscillation;
    Init();
    DDRD &= ~(1<<2); // Change Port D Pin 2 to input
    StatusLED(OFF);
    while(1)
    {
        count72kHz=0;
        oscillation = FALSE;
    }
}
```

```

while (count72kHz<100) {
    // Detect low level
    if ((PIND & (1<<2)) == 0) oscillation = TRUE;
}
// If oscillator is running, no metal object is within
// range, so LED should be off
if (oscillation) FrontLED(OFF); else FrontLED(ON);
}
return 0;
}

```

This program will switch off the LED as soon as the oscillator is working.

Depending on the activated detection method (decay mode of the oscillations respectively variations of the oscillator frequency), we will need different calibration methods. At first we will explain the calibration for the decay mode of the oscillations. This simpler method should always be preferred for testing the system (with the previously referenced program).

If the red LED at the extension board is not activated after switching on the system, please turn the spindle trimmer clockwise until the LED is activated. The trimmer may be turned ten rotations clockwise, respectively counter-clockwise and will not be damaged if you exceed the operating area. If turning over ten rotations does not effect the system we will have to proceed with the debugging phase...

After a successful calibration please place the robot on top of a definitely non-metallic location (on top of a plastic or wooden box, respectively on a table without nails or screws...) and turn the trimmer counter-clockwise until the LED extinguishes. You may have to repeat the calibration procedure again, as temperature drifts and changing battery levels are influencing the operation-point of the system. Careful calibrations will increase the sensitivity of the system but will also reduce the intervals between re-calibrations.

As soon as you near the ping-pong ball with a metallic object (e.g. a screwdriver), the LED should be activated – at least the moment you touch the system.

The sensor will now be sensitive enough to detect even small pieces of aluminium foil at the backside of a paper board.

In order to monitor the frequency variations you should start by calibrating the sensor in the exact application mode. In this mode the robot is to be placed in a position for the maximal level of the expected sensor signal (e.g. very close to the metallic object). Then turn the trimmer counter-clockwise as long as the LED is activated. Now you may use the following program for demonstration purposes (MinesweeperTest2):

```

#include "asuro.h"
#include <stdio.h>

extern volatile unsigned char count72kHz;

int main(void)
{
    unsigned char oldlevel=0, newlevel;
    unsigned int freq;
    int i;
    char s[9];
    Init();

    DDRD &= ~(1<<2); // Change Port D Pin 2 to input
    StatusLED(OFF);
}

```

```

while(1)
{
  freq=0;
  for (i=0; i<100; i++) {
    count72kHz=0; // This counter is incremented in timer interrupt
    FrontLED(OFF);
    while (count72kHz<72) {
      // Detect level change
      newlevel = PIND & (1<<2);
      if (oldlevel != newlevel) {
        oldlevel = newlevel;
        freq++;
        FrontLED(ON);
      }
    }
  }
  sprintf(s,"%5d\n\r",freq);
  SerWrite(s,7);
}
return 0;
}

```

2.7 The debugging procedure

If the system does not work as expected, we will have to start the debugging procedure. Unfortunately we cannot provide as many debugging options as for the basic ASURO-system. The use of a multimeter may help to debug the system.

- Please start by checking the correct compilation of the test program. Has the program really been flashed? Proceed by checking the soldering locations and the polarities and values for the components.
- Check the connections of the coil system for correct removing of the isolations and applying the solder. Did you really remove the isolation? At a *deactivated* (!) robot you should be able to monitor a resistance of 30Ω at the terminals for the coil.

At much higher measured resistor values, the cable has not been connected correctly, some isolation at the copper cable has not been removed properly – preventing good conductivity - or the thin copper wire of the coil has been disrupted at the assembly phase. The last problem often occurs in the neighbourhood of the capacitor.

At much lower measured resistor values, you may locate a short circuit at the printed circuit board or in the coil. You are now advised to remove the cable from the screw terminal and to repeat the measurement of the resistance value at the screw terminal. If the resistance is much higher than 30 Ohms, you may locate the short circuit area at the coil module.

- At an activated robot you should be able to monitor an operating voltage in the range 4.5 .. 5.5V between the terminals GNDOUT1 and VCCOUT1. If the operating voltage does not meet these specifications the battery may be empty, the robot may be deactivated, the connections for the battery compartment may be interrupted or a cold soldering point occurs in the neighbourhood of the rear extended plugs at the extension board or the robot itself.
- The voltage for the operational amplifier may be monitored between pin 4 (minus) (at the bottom left side if the mark at the IC is at the topside) and pin 8 (plus) (at the top right side). The voltage should be at least 2V higher than the battery voltage.