

# Spezifikation für Freigabe / specification for release

Kunde / customer :  
 Artikelnummer / part number :

**7499511440**



Bezeichnung : **LAN-Übertrager WE-RJ45LAN 10/100/1000 BaseT PoE+**  
 description : **LAN-Transformer WE-RJ45LAN 10/100/1000 BaseT PoE+**

DATUM / DATE : 2011-10-20

## A Mechanische Abmessungen / dimensions :

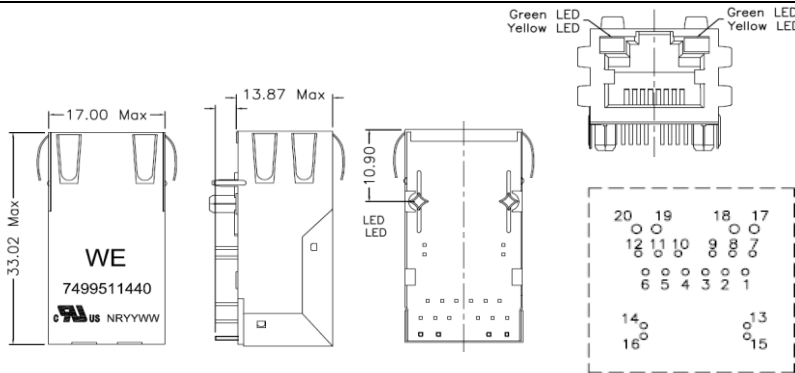

## B Lötpad / soldering spec. :

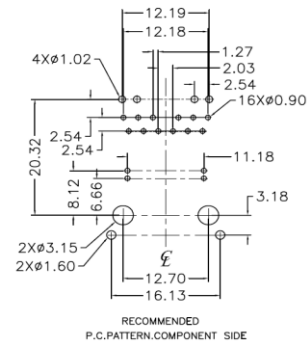

## C Elektrische Eigenschaften / electrical properties :

Eigenschaften / properties	Testbedingungen / test conditions		Wert / value	Einheit / unit	tol.
Induktivität / Inductance	100kHz / 100mV @ 8mA DC-Bias	OCL	350	µH	min.
Übersetzungsverhältnis / Turns ratio	100kHz / 100mV	TR	1 : 1	Tx	3%
			1 : 1	Rx	
Insertion Loss	1-100MHz	IL	-1,1	dB	max.
Return Loss	1-30MHz @ 100Ω	RL	-16	dB	min.
	60-80MHz @ 100Ω		-12,0		
	80-100MHz @ 100Ω		-10		
Cross Talk	1-100MHz	CT	-30	dB	min.
Common Mode Rejection	1-50MHz	CMR	-30	dB	min.
	50-130MHz		-20		

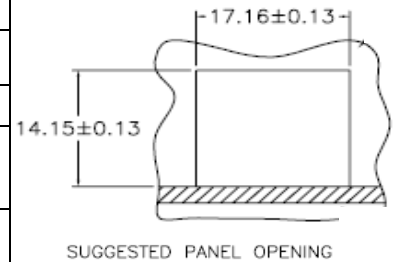

## D Prüfgeräte / test equipment :

HP4395A

## E Testbedingungen / test conditions :

Luftfeuchtigkeit / humidity: 33%  
 Umgebungstemperatur / temperature: +25°C

## F Werkstoffe & Zulassungen / material & approvals :

Basismaterial / base material: Ferrit/ ferrite  
 Draht / wire: 4UEW 180°C  
 Kontaktmaterial/ contact plating: 100% tin w. nickel underplating  
 30µ"gold plating on contact area  
 Gehäuse / housing: Thermoplastic UL-94V0  
 LED: 1,8-2,8 V/ 14mA  
 Shield: 50µ" nickel over 0.01" cooper alloy

## G Eigenschaften / general specifications :

Betriebstemp. / operating temperature: 0°C - + 70°C  
 Hochspannungsprüfung / Hipot test: 1500Vrms 1min.  
 Geeignet für 1000BaseT-Anwendungen gemäß IEEE 802.3at / Compliant with IEEE 802.3at for 1000BaseT

Freigabe erteilt / general release:	Kunde / customer		
	Datum / date	Unterschrift / signature	
	Würth Elektronik	Mle	Revision 02 2011-10-20
		Mle	Revision 01 (preliminary) 2011-09-13
		Mle	Revision 00 2011-08-26
Geprüft / checked	Kontrolliert / approved	Name	Änderung / modification Datum / date

### Würth Elektronik eiSos GmbH & Co.KG

D-74638 Waldenburg · Max-Eyth-Straße 1 - 3 · Germany · Telefon (+49) (0) 7942 - 945 - 0 · Telefax (+49) (0) 7942 - 945 - 400  
 http://www.we-online.com

# Spezifikation für Freigabe / specification for release

Kunde / customer :

Artikelnummer / part number :

**7499511440**



Bezeichnung : LAN-Übertrager WE-RJ45LAN 10/100/1000 BaseT PoE+

description : LAN-Transformer WE-RJ45LAN 10/100/1000 BaseT PoE+

DATUM / DATE : 2011-10-20

## H Schaltbild / Schematics :

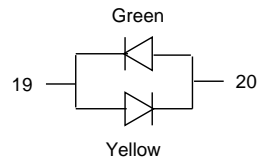
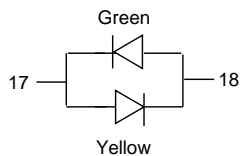
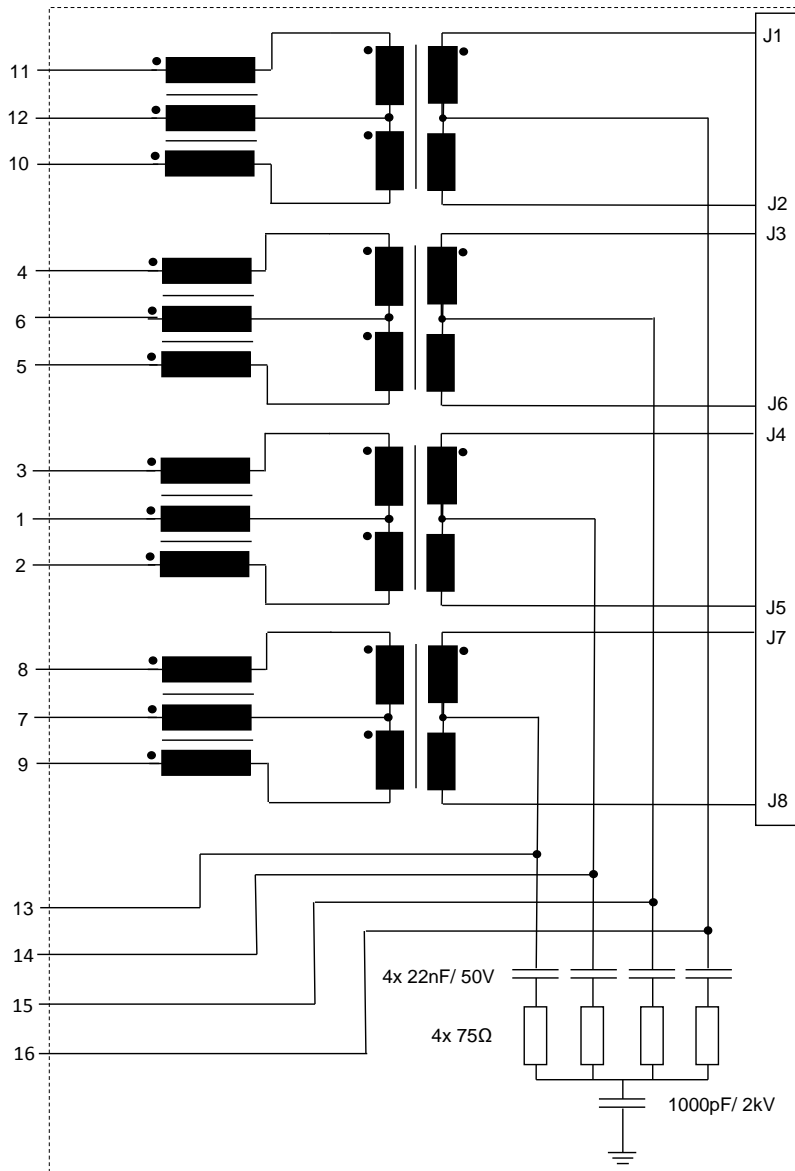

Datum / date	Unterschrift / signature		
	<b>Würth Elektronik</b>	Mle	Revision 02 2011-10-20
		Mle	Revision 01 (preliminary) 2011-09-13
		Mle	Revision 00 2011-08-26
Geprüft / checked	Kontrolliert / approved	Name	Änderung / modification Datum / date

### Würth Elektronik eiSos GmbH & Co.KG

D-74638 Waldenburg · Max-Eyth-Straße 1 - 3 · Germany · Telefon (+49) (0) 7942 - 945 - 0 · Telefax (+49) (0) 7942 - 945 - 400  
http://www.we-online.com

# Spezifikation für Freigabe / specification for release

Kunde / customer :  
 Artikelnummer / part number : **7499511440**  
 Bezeichnung : LAN-Übertrager WE-RJ45LAN 10/100/1000 BaseT PoE+  
 description : LAN-Transformer WE-RJ45LAN 10/100/1000 BaseT PoE+



DATUM / DATE : 2011-10-20

## I Verpackungsspezifikation / package specification :

Tray

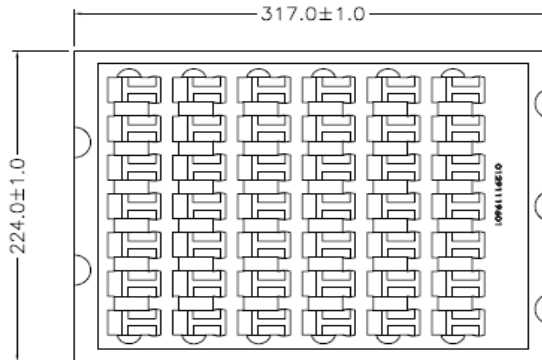

Carton

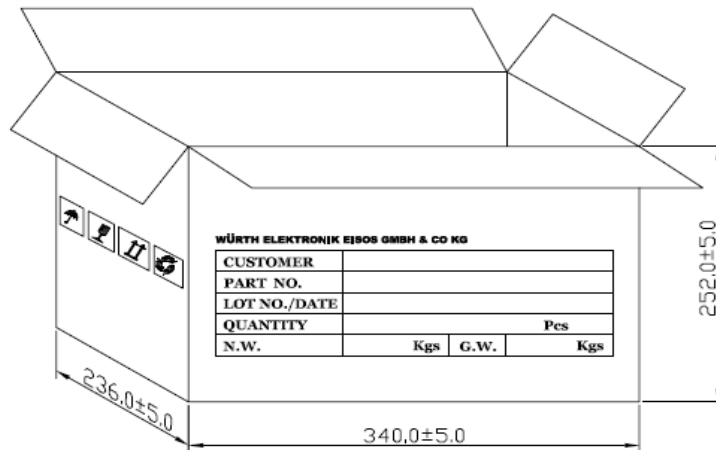

PACKING QUANTITY:

42pcs Finished Goods / Tray

12 Tray (504pcs Finished Goods) / Carton

**dimensions in mm**

Freigabe erteilt / general release:	<b>Kunde / customer</b>	#####	#BEZUG!	#BEZUG!
		#####	#BEZUG!	#BEZUG!
		#####	#BEZUG!	#BEZUG!
Datum / date	Unterschrift / signature			
	<b>Würth Elektronik</b>	Mle	Revision 02	2011-10-20
		Mle	Revision 01 (preliminary)	2011-09-13
		Mle	Revision 00	2011-08-26
Geprüft / checked	Kontrolliert / approved	Name	Änderung / modification	Datum / date

This electronic component has been designed and developed for usage in general electronic equipment. Before incorporating this component into any equipment where higher safety and reliability is especially required or if there is the possibility of direct damage or injury to human body, for example in the range of aerospace, aviation, nuclear control, submarine, transportation, (automotive control, train control, ship control), transportation signal, disaster prevention, medical, public information network etc, Würth Elektronik eISos GmbH must be informed before the design-in stage. In addition, sufficient reliability evaluation checks for safety must be performed on every electronic component which is used in electrical circuits that require high safety and reliability functions or performance.

### Würth Elektronik eISos GmbH & Co.KG

D-74638 Waldenburg · Max-Eyth-Straße 1 - 3 · Germany · Telefon (+49) (0) 7942 - 945 - 0 · Telefax (+49) (0) 7942 - 945 - 400  
<http://www.we-online.com>