

CR65 series, with a blue case, outside the US and the UK.

# PT65 series

## Rotary code switches

Through-hole

UG1006-A



- 4 actuator types
- Save board space
- Highly reliable
- Solder and flux sealed, washable

PT65			
<b>SERIES</b>	<b>Actuators</b>	<b>Codes</b>	<b>Terminals</b>
	<ul style="list-style-type: none"> <li>1 Screwdriver</li> <li>3 Spindle</li> <li>5 Segment wheel</li> <li>7 Accessories</li> </ul>	<ul style="list-style-type: none"> <li>01 BCD</li> <li>02 BCD complement</li> <li>03 Hexadecimal</li> <li>06 Hexadecimal complement</li> </ul>	<ul style="list-style-type: none"> <li>(none) Straight</li> <li>L254 Right angle, spacing 2,54 (.100)</li> <li>L508 Right angle, spacing 5,08 (.200)</li> </ul>

### ELECTRICAL SPECIFICATIONS

- Operating voltage : 24 VDC max.
- Contact load, static : 400mA max.
- Contact load, dynamic : 150mA max.
- Initial contact resistance : 80 mΩ max.
- Insulation resistance : 100 MΩ min.

### MECHANICAL AND THERMAL SPECS

- Torque : 0,7 Ncm min.
- Expected life : 10.000 cycles min.
- Operating temperature : -20°C to +70°C

### MATERIALS

- Base : UL94-V0, high temperature thermoplastic
- Cover : UL94-V0, high temperature thermoplastic, grey
- Actuator : PA 4.6 nylon
- Contacts : gold over nickel plated phosphor bronze
- Terminals : tin plated

### SOLDER RECOMMENDATIONS

(DIN CEI 68-2-20)

- Manual soldering : 340°C max. for 2 seconds max.
- Wave soldering : 260°C max. for 10 seconds max.

### PACKAGING

- Switches for screwdriver slot or accessory actuation (PT651 and PT657) : tubes of 50 pieces
- Switches with spindle (PT653) or segment wheel (PT655) : candy trays of 50 pieces
- Accessories : bags of 50 pieces

### DIMENSIONS

Screwdriver slot, straight terminals

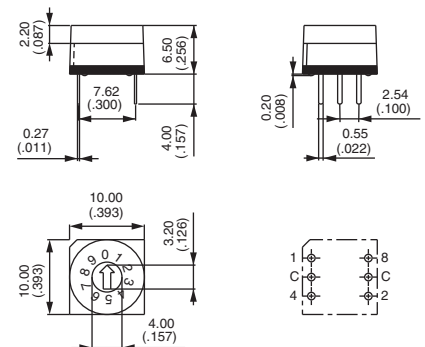

Dimensions : first dimensions are in mm while inches are shown as bracketted numbers.

# PT65 series

## Rotary code switches

Through-hole

### ACTUATORS

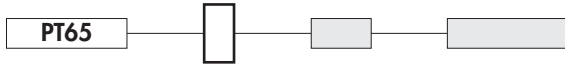

**1 Screwdriver**

**3 Spindle (grey)**

**5 Segment wheel (grey)**

**7 Accessories**

See next page

### CODES / TRUTH TABLES

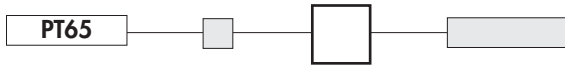

**01 BCD**

	C	1	2	4	8	
0	●					0
1	●	●				1
2	●		●			2
3	●	●	●			3
4	●			●		4
5	●	●		●		5
6	●		●	●		6
7	●	●	●	●		7
8	●				●	8
9	●	●			●	9

**02 BCD complement**

	C	1	2	4	8	
0	●	●	●	●	●	0
1	●	●	●	●	●	1
2	●	●	●	●	●	2
3	●	●	●	●	●	3
4	●	●	●	●	●	4
5	●	●	●	●	●	5
6	●	●	●	●	●	6
7	●	●	●	●	●	7
8	●	●	●	●	●	8
9	●	●	●	●	●	9

**03 Hexadecimal**

	C	1	2	4	8	
0	●					0
1	●	●				1
2	●		●			2
3	●	●	●			3
4	●			●		4
5	●	●		●		5
6	●		●	●		6
7	●	●	●	●		7
8	●				●	8
9	●	●			●	9
10	●		●		●	A
11	●	●			●	B
12	●		●		●	C
13	●	●		●	●	D
14	●		●	●	●	E
15	●	●	●	●	●	F

**06 Hexadecimal complement**

	C	1	2	4	8	
0	●	●	●	●	●	0
1	●	●	●	●	●	1
2	●	●	●	●	●	2
3	●	●	●	●	●	3
4	●	●	●	●	●	4
5	●	●	●	●	●	5
6	●	●	●	●	●	6
7	●	●	●	●	●	7
8	●	●	●	●	●	8
9	●	●	●	●	●	9
10	●	●	●	●	●	A
11	●	●	●	●	●	B
12	●	●	●	●	●	C
13	●	●	●	●	●	D
14	●	●	●	●	●	E
15	●	●	●	●	●	F

▲ Position      ▲ Marking

### TERMINALS



**(none) Straight**

**L254 Right angle spacing 2,54 (.100)**

**L508 Right angle spacing 5,08 (.200)**

# PT65 series

## Rotary code switches

Through-hole

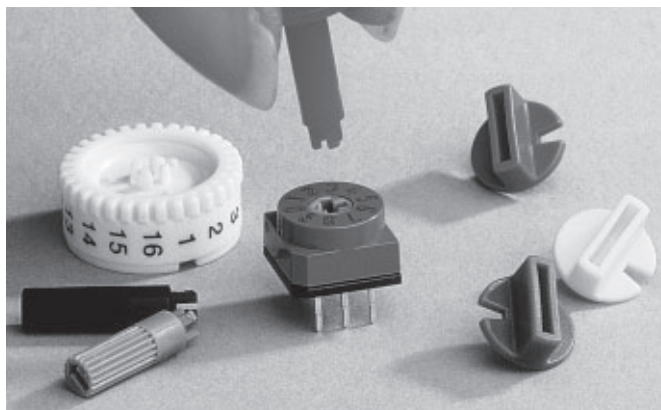

### ACCESSORIES ADAPTED TO YOUR APPLICATIONS

Basic model PT657 has been designed to accept different actuators with snap-in connection.

According to your application, you can choose between spindles or plastic knobs in two different lengths and a Ø 17 mm (.669) knurled wheel for lateral marking.

Standard colours are shown below. Special colours are also available on request.

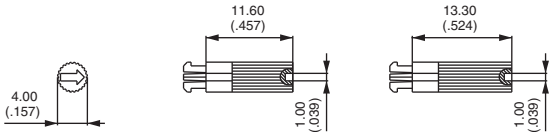
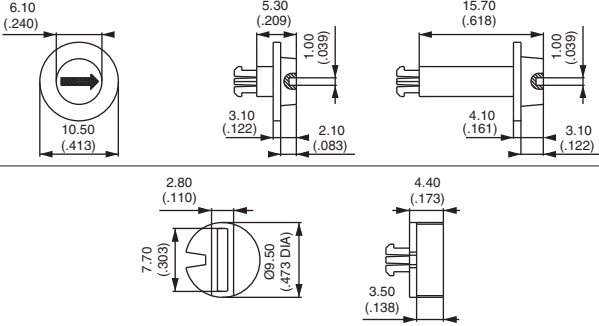
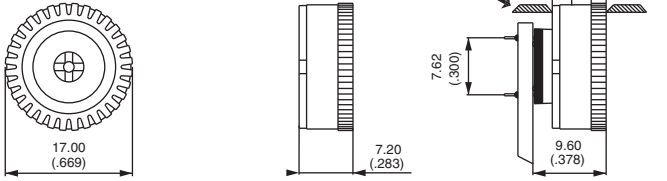
<p><b>SPINDLES</b> Length 11,6 mm (standard)  Length 13,3 mm</p>	<p><b>P/N</b> <b>U4822</b> <b>U4824</b> <b>U4832</b></p>	<p><b>COLOURS</b> black grey black</p>	
<p><b>PLASTIC KNOBS</b> Length 5,3 mm (standard) Length 15,7 mm  Length 4,4 mm</p>	<p><b>P/N</b> <b>U4906</b> <b>U4916</b>  <b>U4941</b> <b>U4943</b> <b>U4944</b> <b>U4945</b> <b>U4946</b></p>	<p><b>COLOURS</b> red red  blue green grey yellow red</p>	
<p><b>KNURLED WHEEL</b> (unmarked - marking on request)</p>	<p><b>P/N</b> <b>U4847/1</b></p>	<p><b>COLOUR</b> white/black</p>	<p>→ Panel</p> 

### STANDARD PRODUCTS

MODELS	FOR SCREWDRIVER		WITH SPINDLE	WITH SEGMENT WHEEL		FOR ACCESS.
	Upper actuation	Side actuation	Upper actuation	Upper actuation	Side actuation	Upper actuation
BCD	<b>PT65101</b>	<b>PT65101L254</b>	<b>PT65301</b>	<b>PT65501</b>	-	<b>PT65701</b>
		<b>PT65101L508</b>			-	
BCD complement	<b>PT65102</b>	-	-	<b>PT65502</b>	-	-
Hexadecimal	<b>PT65103</b>	<b>PT65103L254</b>	<b>PT65303</b>	<b>PT65503</b>	<b>PT65303L254</b>	-
		<b>PT65103L508</b>				-
Hexadecimal complem.	<b>PT65106</b>	-	-	-	-	-