

THB 3 Series

Application Note

DC/DC Converter 4.5 to 9Vdc, 9 to 18Vdc, 18 to 36Vdc or 36 to 75dc Input
5.0Vdc, 12Vdc & 24Vdc Single Outputs and ± 12 & ± 15 Vdc Dual Outputs, 3W

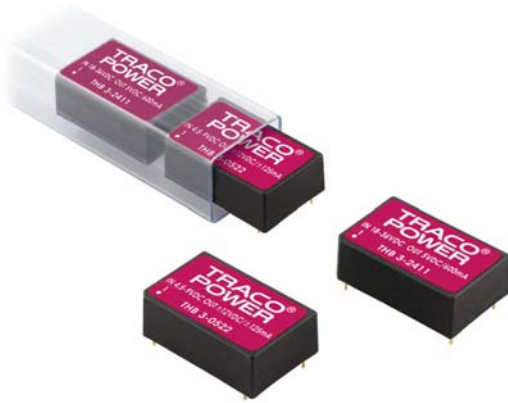

226037

Complete THB 3 datasheet can be downloaded at:
<http://www.tracopower.com/products/thb3.pdf>

Features

- Single output up to 600mA
- Dual output up to ± 125 mA
- 3 watts maximum output power
- 2:1 input voltage range of 4.5-9Vdc, 9-18, 18-36Vdc and 36-75Vdc
- High efficiency up to 84%
- Input to output isolation: 4000Vac for 1 minute
- Reinforced insulation based on 300Vac working voltage
- Low leakage current
- Low input to output isolation capacitance
- Large operating temperature range from -40°C up to $+85^{\circ}\text{C}$
- Compliance with EN 55022 class A
- Output short circuit protection
- Approved according to IEC/EN/UL 60950-1
- Approved according to IEC/EN/UL 60601-1

Applications

- Distributed power architectures
- Workstations
- Computer equipment
- Communications equipment

General Description

The THB 3-Series power modules are specially designed to provide ultra-high levels of isolation 400Vac (5600Vdc) in a low profile 24-pin DIP package. Operating input voltage ranges of 4.5-9Vdc, 9-18Vdc, 18-36Vdc and 36-75Vdc which provide precisely regulated output voltages of 5V, 12V, 24V, ± 12 V and ± 15 VDC.

The -40°C to $+75^{\circ}\text{C}$ operating temperature range makes it ideal for data communication equipments, mobile battery driven equipments, distributed power systems, telecommunication equipments, mixed analog/digital subsystems, process/machine control equipments, computer peripheral systems and industrial robot systems.

The modules have a maximum power rating of 3W and a typical full-load efficiency of 84%, continuous short circuit, EN55022 Class A conducted noise compliance minimize design-in time, cost and eliminate the need for external filtering.

Table of contents

Absolute Maximum Rating.....	P2	Thermal Consideration.....	P26
Output Specification.....	P2	Mechanical Data.....	P27
Input Specification.....	P3	Recommended Pad Layout Single & Dual...	P27
General Specification.....	P4	Packaging Information.....	P28
Characteristic Curves.....	P5	Soldering and Reflow Consideration.....	P28
Testing Configurations.....	P24	Part Number Structure.....	P29
EMC Considerations.....	P25	Safety and Installation Instruction.....	P30
Input Source Impedance.....	P26	MTBF and Reliability.....	P30
Short Circuitry Protection.....	P26		

Absolute Maximum Rating					
Parameter	Model	Min	Max	Unit	
Input Voltage Input Surge Voltage (1 second)	5Vdc Input Models	-0.7	11	Vdc	
	12Vdc Input Models	-0.7	25		
	24Vdc Input Models	-0.7	50		
	48Vdc Input Models	-0.7	100		
Operating Ambient Temperature Without Derating	All	-40	+70	°C	
		With Derating	-40		
Operating Case Temperature	All	-40	+95	°C	
Storage Temperature	All	-40	+125	°C	

Output Specification					
Parameter	Model	Min	Nominal	Max	Unit
Output Voltage ($V_{in} = V_{in\ nom}$; Full Load; $T_A = 25^\circ\text{C}$)	THB 3-xx11	4.95	5	5.05	Vdc
	THB 3-xx12	11.88	12	12.12	
	THB 3-xx15	23.76	24	24.24	
	THB 3-xx22	± 11.88	± 12	± 12.12	
	THB 3-xx23	± 14.85	± 15	± 15.15	
Output Regulation					
Line ($V_{in\ min}$ to $V_{in\ max}$ at Full Load)		---	± 0.3	± 0.5	%
Output Regulation					%
Load (25% to 100% of Full Load)		---	± 0.5	± 1.0	
Output Ripple & Noise					
Peak-to-Peak (20MHz bandwidth)	5V Output Models	---	75	100	mV pk-pk
	Other Output Models	---	100	150	
Temperature Coefficient	All	---	± 0.02	± 0.05	%/°C
Dynamic Load Response	All				
($V_{in} = V_{in\ nom}$; $T_A = 25^\circ\text{C}$ Load step change					
75% to 100% or 100% to 75% of full Load)					
Peak Deviation		---	± 3	± 6	%
Recovery Time ($V_{out} < 10\%$ peak deviation)		---	150	500	μs
Output Current	THB 3-xx11	90.0	---	600	mA
	THB 3-xx12	37.5	---	250	
	THB 3-xx15	18.8	---	125	
	THB 3-xx22	± 18.8	---	± 125	
	THB 3-xx23	± 15.0	---	± 100	
Output Over Current Protection	All	120	---	---	%FL
Output Short Circuit Protection	All	Continuous			

Input Specification					
Parameter	Model	Min	Nominal	Max	Unit
Operating Input Voltage	5V Input Models	4.5	5	9	Vdc
	12V Input Models	9	12	18	
	24V Input Models	18	24	36	
	48V Input Models	36	48	75	
Under Voltage Lockout Turn-on Threshold	5V Input Models	3.7	4	4.5	Vdc
	12V Input Models	8	8.5	9	
	24V Input Models	15	17	18	
	48V Input Models	30	33	36	
Under Voltage Lockout Turn-off Threshold	5V Input Models	---	---	4	Vdc
	12V Input Models	---	---	8.5	
	24V Input Models	---	---	17	
	48V Input Models	---	---	34	
Input reflected ripple current (20MHz bandwidth) (Measured with a inductor 4.7µH and Capacitance 220µF, ESR < 1.0 ohm at 100KHz to simulated source) impedance	5V Input Models	---	60	---	mA pk-pk
	12V Input Models	---	30	---	
	24V Input Models	---	15	---	
	48V Input Models	---	10	---	
Input Current ($V_{in} = V_{in nom}$; Full Load)	THB 3-0511	---	857	---	mA
	THB 3-0512	---	800	---	
	THB 3-0515	---	800	---	
	THB 3-0522	---	800	---	
	THB 3-0523	---	800	---	
	THB 3-1211	---	338	---	
	THB 3-1212	---	313	---	
	THB 3-1215	---	313	---	
	THB 3-1222	---	313	---	
	THB 3-1223	---	313	---	
	THB 3-2411	---	160	---	
	THB 3-2412	---	151	---	
	THB 3-2415	---	151	---	
	THB 3-2422	---	151	---	
	THB 3-2423	---	151	---	
	THB 3-4811	---	80	---	
	THB 3-4812	---	75	---	
	THB 3-4815	---	75	---	
THB 3-4822	---	75	---		
THB 3-4823	---	75	---		

Input Specification					
Parameter	Model	Min	Nominal	Max	Unit
Input No Load current (Typical value at $V_{in} = V_{in\ nom}$; No Load)	THB 3-0511	---	40	---	mA
	THB 3-0512				
	THB 3-0515				
	THB 3-0522				
	THB 3-0523	---	30	---	
	THB 3-1211				
	THB 3-1212				
	THB 3-1215				
	THB 3-1222	---	20	---	
	THB 3-1223				
	THB 3-2411				
	THB 3-2412				
	THB 3-2415	---	10	---	
	THB 3-2422				
	THB 3-2423				
	THB 3-4811				
	THB 3-4812	---	---	---	
	THB 3-4815				
THB 3-4822					
THB 3-4823					

General Specification					
Parameter	Model	Min	Nominal	Max	Unit
Efficiency ($V_{in} = V_{in\ nom}$; Full Load; $T_A = 25^\circ\text{C}$)	THB 3-0511	---	70	---	%
	THB 3-0512	---	75	---	
	THB 3-0515	---	76	---	
	THB 3-0522	---	75	---	
	THB 3-0523	---	75	---	
	THB 3-1211	---	74	---	
	THB 3-1212	---	80	---	
	THB 3-1215	---	81	---	
	THB 3-1222	---	80	---	
	THB 3-1223	---	80	---	
	THB 3-2411	---	78	---	
	THB 3-2412	---	83	---	
	THB 3-2415	---	84	---	
	THB 3-2422	---	83	---	
	THB 3-2423	---	83	---	
	THB 3-4811	---	78	---	
	THB 3-4812	---	83	---	
	THB 3-4815	---	84	---	
THB 3-4822	---	83	---		
THB 3-4823	---	83	---		
Isolation Voltage Input to Output (for 60 seconds)	All	4000	---	---	Vac
Isolation Resistance	All	10	---	---	GΩ
Isolation Capacitance	All	---	7	13	pF
Switching Frequency	All	---	150	---	KHz
Leakage Current	All	---	---	2	μA
MTBF MIL-STD-217F, $T_A = 25^\circ\text{C}$	All	1'000'000	---	---	Hours

Characteristic Curves

All test conditions are at 25°C. The figures are identical for THB 3-0511

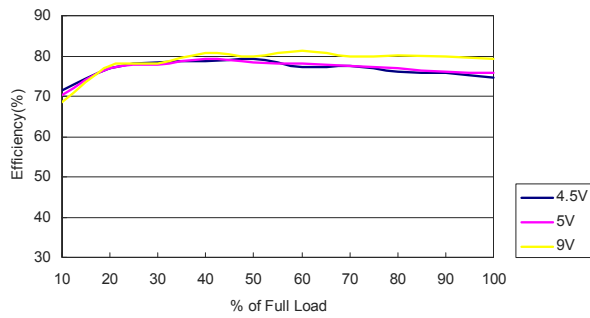

Efficiency Versus Output Current

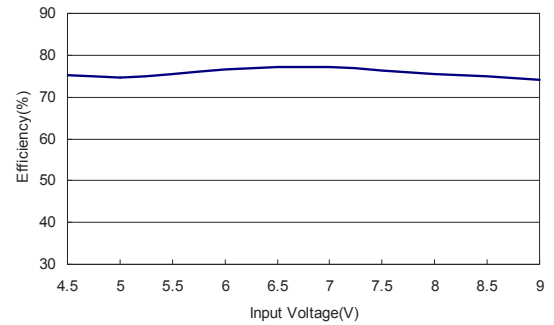

Efficiency Versus Input Voltage. Full Load

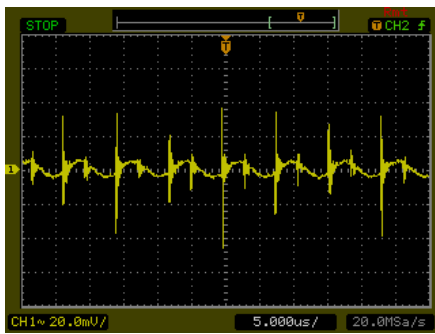

Typical Output Ripple and Noise.
 $V_{in} = V_{in\ nom}$; Full Load; T_A

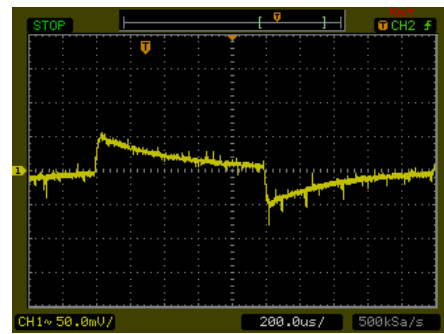

Transient Response to Dynamic Load Change from 100% to 75% of Full Load; $V_{in} = V_{in\ nom}$

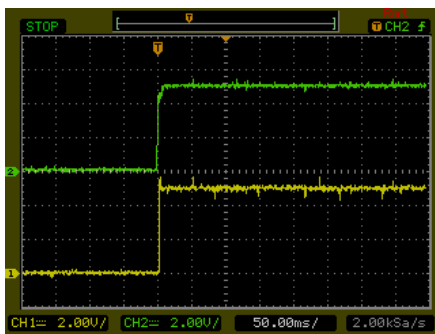

Typical Input Start-Up and Output Rise Characteristic
 $V_{in} = V_{in\ nom}$; Full Load

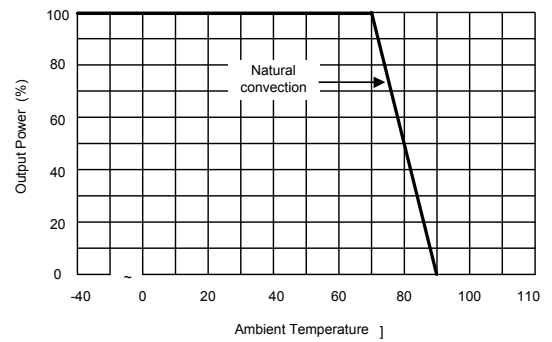

Derating Output Current Versus Ambient Temperature and Airflow

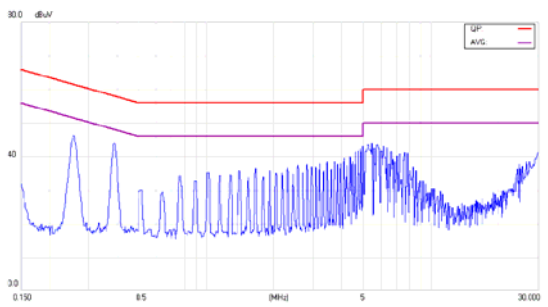

Conduction Emission of EN55022 Class B
 $V_{in} = V_{in\ nom}$; Full Load

Characteristic Curves

All test conditions are at 25°C. The figures are identical for THB 3-0512

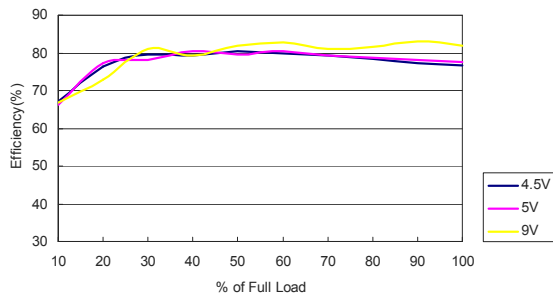

Efficiency Versus Output Current

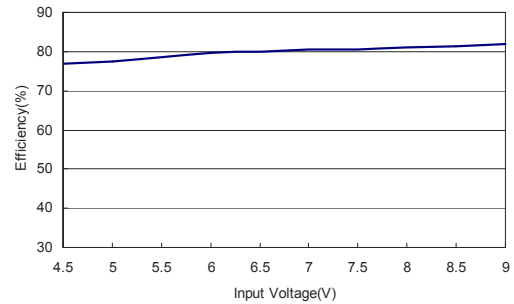

Efficiency Versus Input Voltage. Full Load

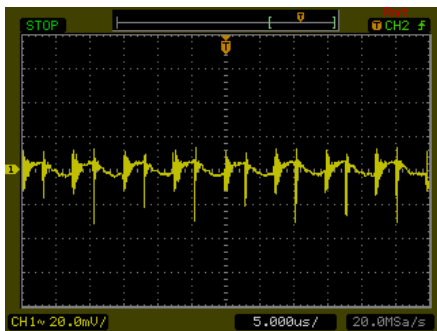

Typical Output Ripple and Noise.
 $V_{in} = V_{in\ nom}$; Full Load; T_A

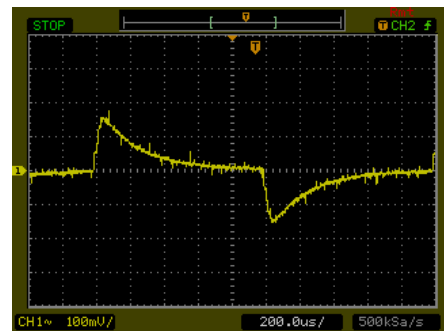

Transient Response to Dynamic Load Change from 100% to 75% of Full Load ; $V_{in} = V_{in\ nom}$

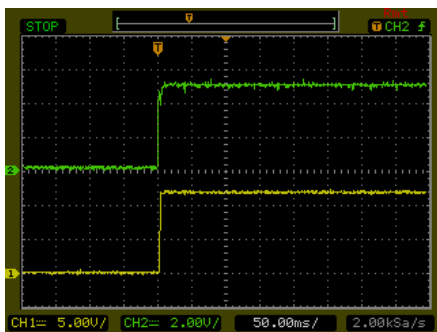

Typical Input Start-Up and Output Rise Characteristic
 $V_{in} = V_{in\ nom}$; Full Load

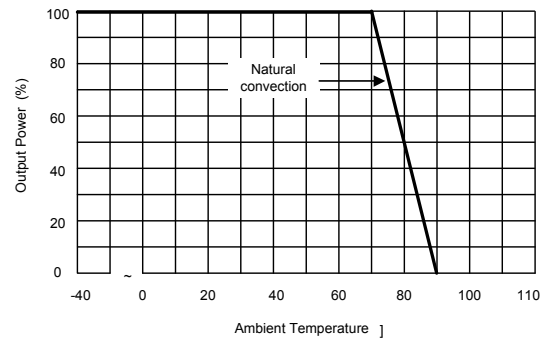

Derating Output Current Versus Ambient Temperature and Airflow

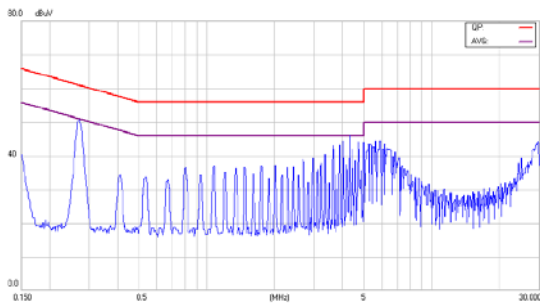

Conduction Emission of EN55022 Class B
 $V_{in} = V_{in\ nom}$; Full Load

Characteristic Curves

All test conditions are at 25°C. The figures are identical for THB 3-0515

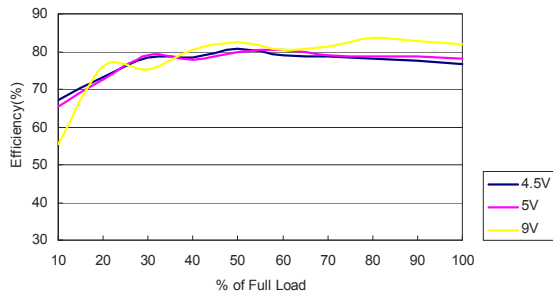

Efficiency Versus Output Current

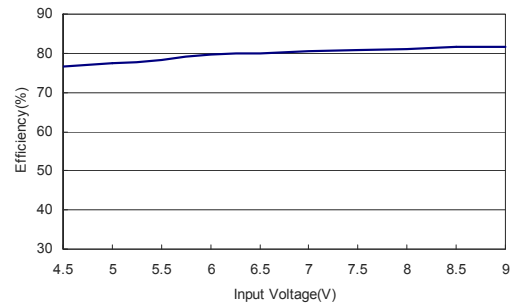

Efficiency Versus Input Voltage. Full Load

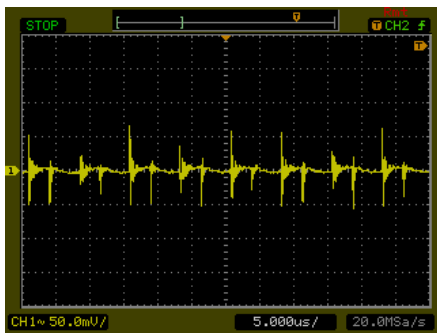

Typical Output Ripple and Noise.
 $V_{in} = V_{in\ nom}$; Full Load; T_A

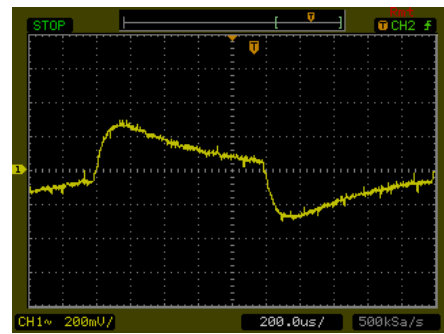

Transient Response to Dynamic Load Change from 100% to 75% of Full Load ; $V_{in} = V_{in\ nom}$

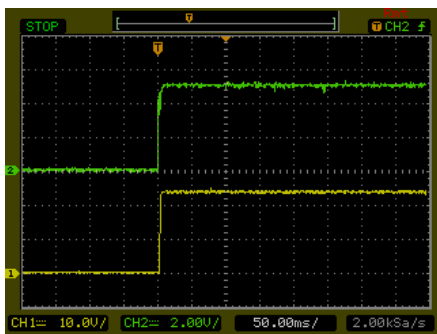

Typical Input Start-Up and Output Rise Characteristic
 $V_{in} = V_{in\ nom}$; Full Load

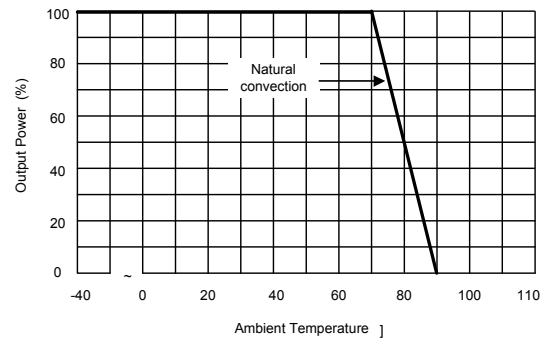

Derating Output Current Versus Ambient Temperature and Airflow

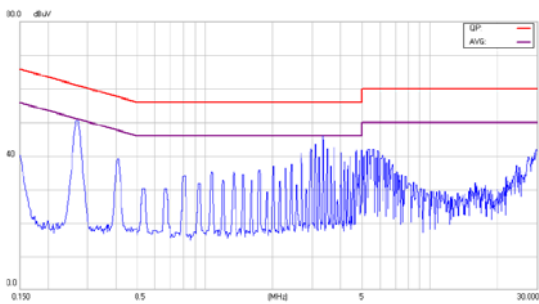

Conduction Emission of EN55022 Class B
 $V_{in} = V_{in\ nom}$; Full Load

Characteristic Curves

All test conditions are at 25°C. The figures are identical for THB 3-0522

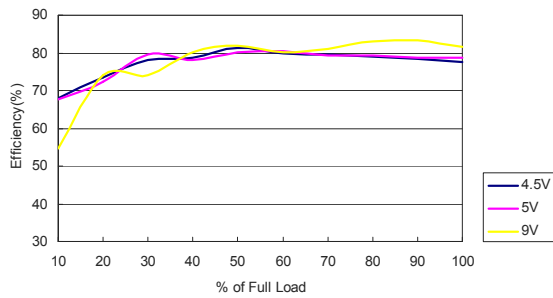

Efficiency Versus Output Current

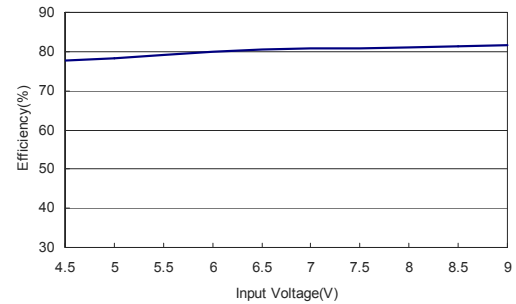

Efficiency Versus Input Voltage. Full Load

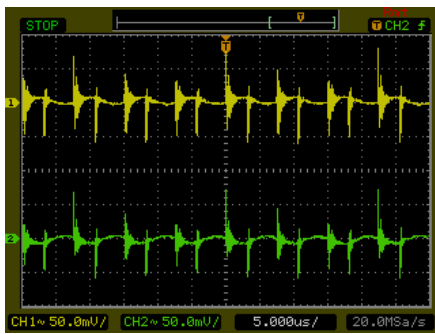

Typical Output Ripple and Noise.
 $V_{in} = V_{in\ nom}$; Full Load; T_A

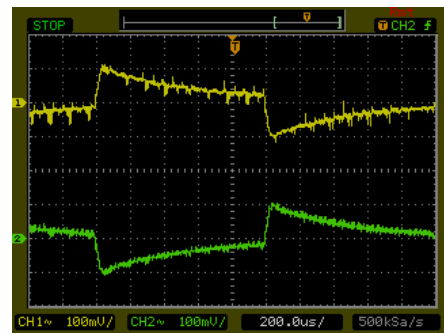

Transient Response to Dynamic Load Change from 100% to 75% of Full Load ; $V_{in} = V_{in\ nom}$

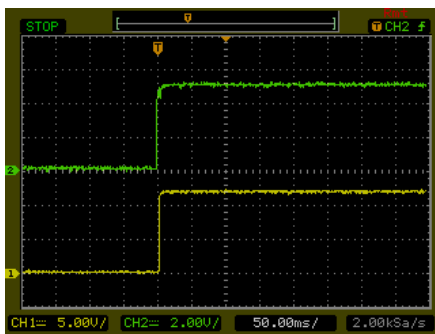

Typical Input Start-Up and Output Rise Characteristic
 $V_{in} = V_{in\ nom}$; Full Load

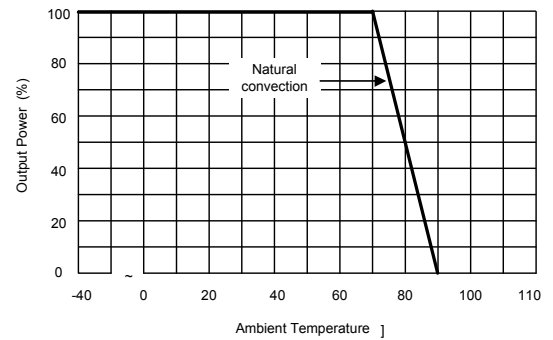

Derating Output Current Versus Ambient Temperature and Airflow

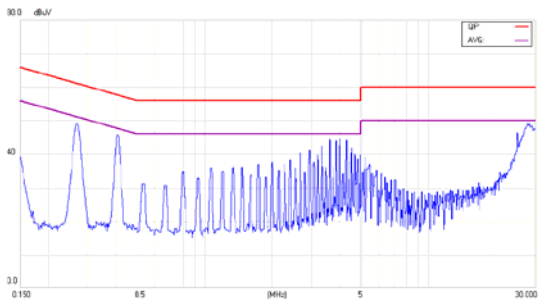

Conduction Emission of EN55022 Class B
 $V_{in} = V_{in\ nom}$; Full Load

Characteristic Curves

All test conditions are at 25°C. The figures are identical for THB 3-0523

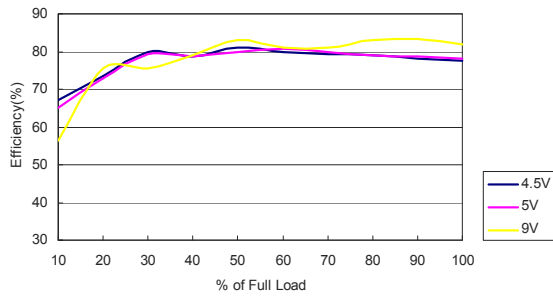

Efficiency Versus Output Current

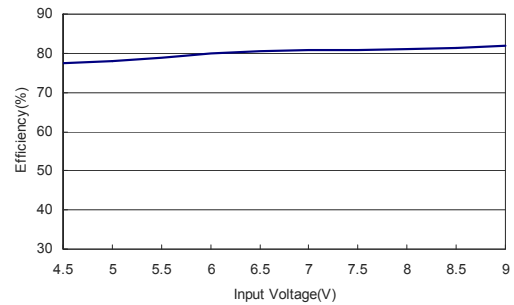

Efficiency Versus Input Voltage. Full Load

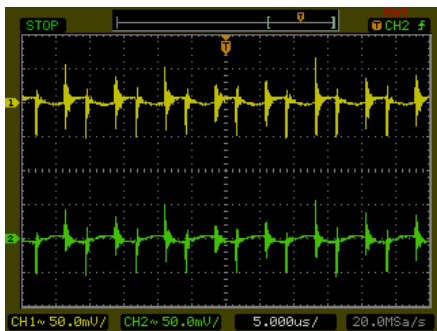

Typical Output Ripple and Noise.
 $V_{in} = V_{in\ nom}$; Full Load; T_A



Transient Response to Dynamic Load Change from 100% to 75% of Full Load ; $V_{in} = V_{in\ nom}$

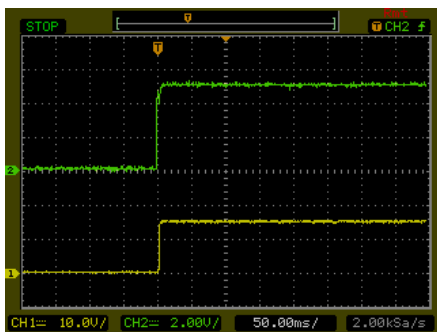

Typical Input Start-Up and Output Rise Characteristic
 $V_{in} = V_{in\ nom}$; Full Load

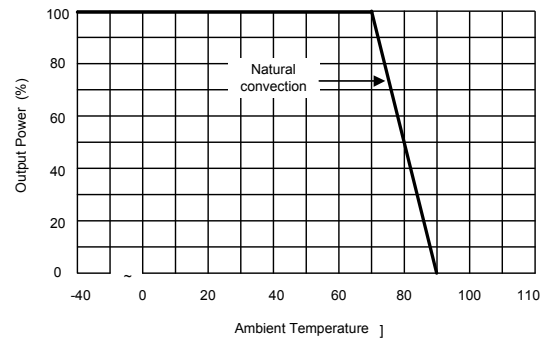

Derating Output Current Versus Ambient Temperature and Airflow

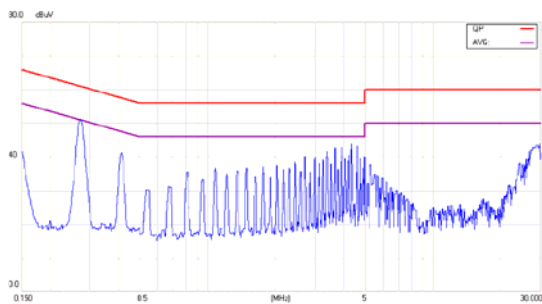

Conduction Emission of EN55022 Class B
 $V_{in} = V_{in\ nom}$; Full Load

Characteristic Curves

All test conditions are at 25°C. The figures are identical for THB 3-1211

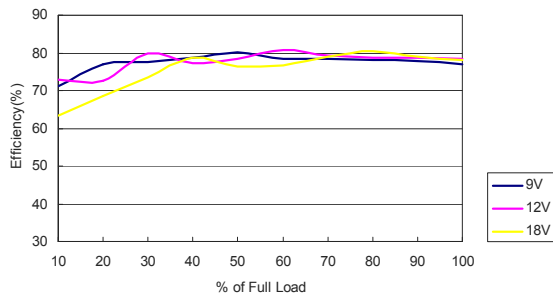

Efficiency Versus Output Current

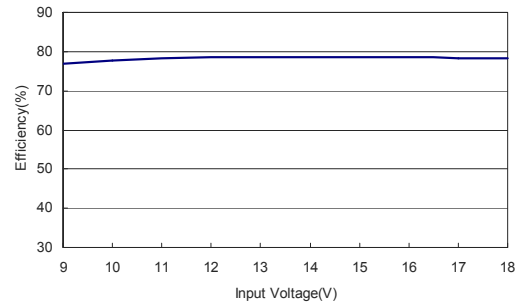

Efficiency Versus Input Voltage. Full Load

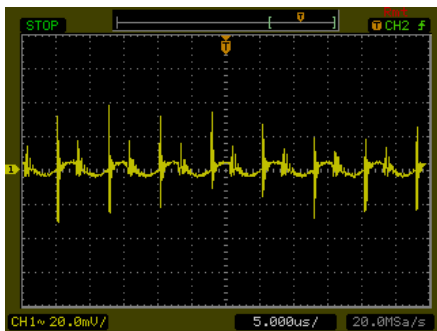

Typical Output Ripple and Noise.
 $V_{in} = V_{in\ nom}$; Full Load; T_A

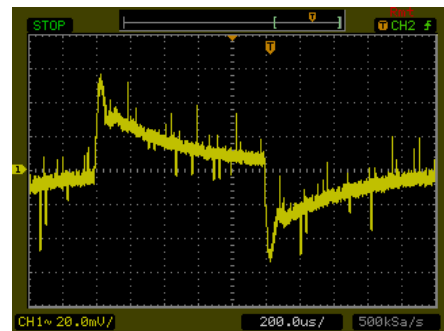

Transient Response to Dynamic Load Change from 100% to 75% of Full Load ; $V_{in} = V_{in\ nom}$

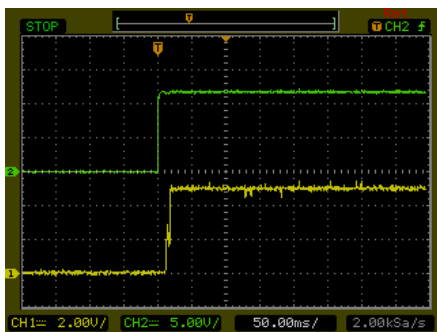

Typical Input Start-Up and Output Rise Characteristic
 $V_{in} = V_{in\ nom}$; Full Load

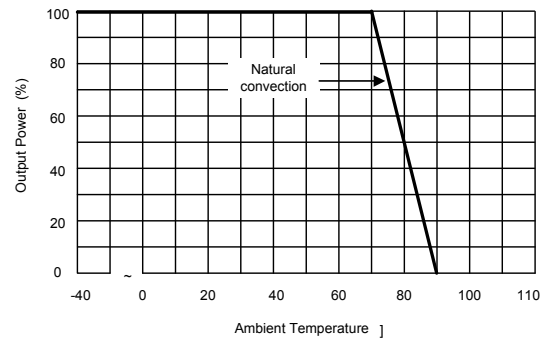

Derating Output Current Versus Ambient Temperature and Airflow

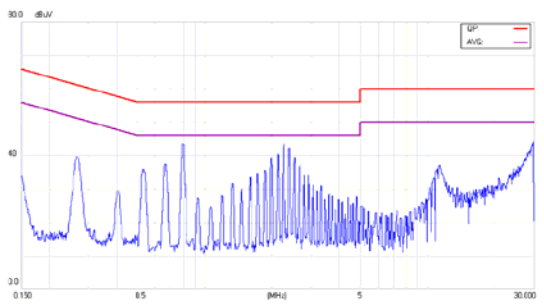

Conduction Emission of EN55022 Class B
 $V_{in} = V_{in\ nom}$; Full Load

Characteristic Curves

All test conditions are at 25°C. The figures are identical for THB 3-1212

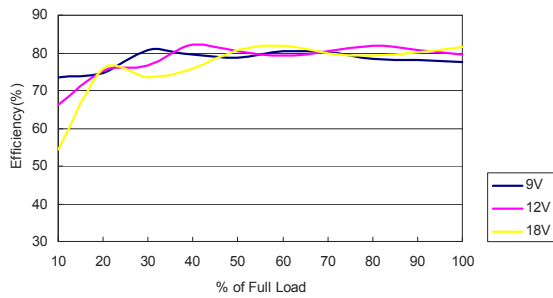

Efficiency Versus Output Current

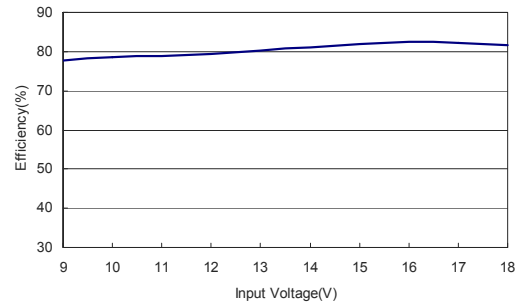

Efficiency Versus Input Voltage. Full Load

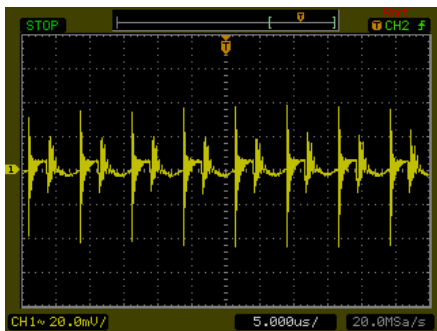

Typical Output Ripple and Noise.
 $V_{in} = V_{in\ nom}$; Full Load; T_A

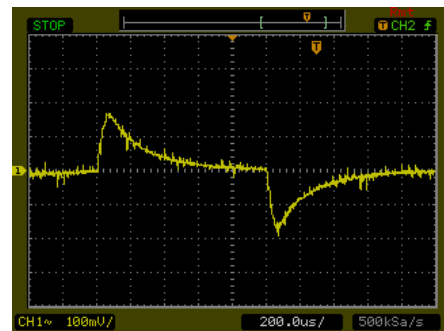

Transient Response to Dynamic Load Change from 100% to 75% of Full Load ; $V_{in} = V_{in\ nom}$

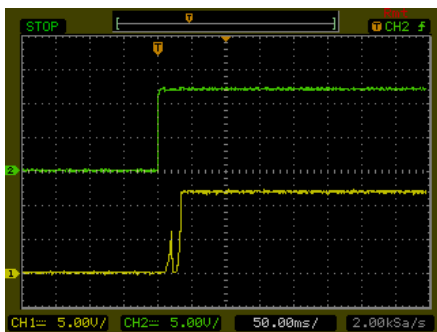

Typical Input Start-Up and Output Rise Characteristic
 $V_{in} = V_{in\ nom}$; Full Load

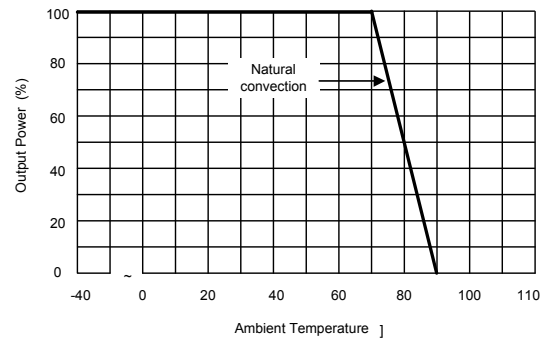

Derating Output Current Versus Ambient Temperature and Airflow

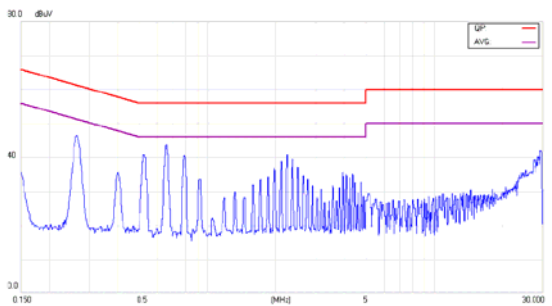

Conduction Emission of EN55022 Class B
 $V_{in} = V_{in\ nom}$; Full Load

Characteristic Curves

All test conditions are at 25°C. The figures are identical for THB 3-1215

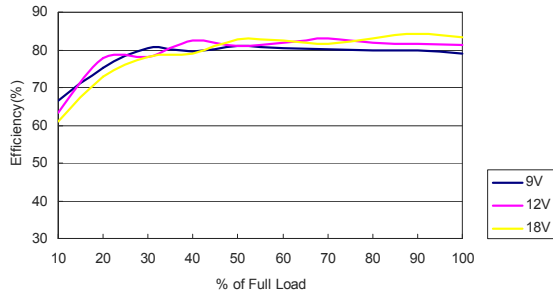

Efficiency Versus Output Current

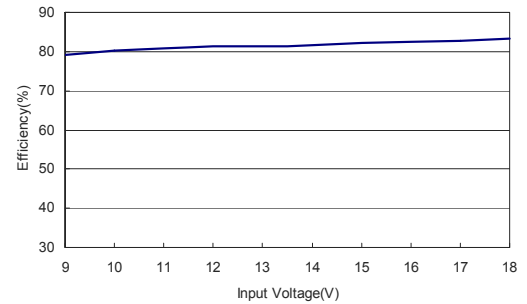

Efficiency Versus Input Voltage. Full Load

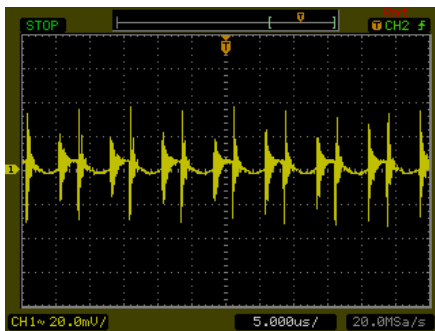

Typical Output Ripple and Noise.
 $V_{in} = V_{in\ nom}$; Full Load; T_A



Transient Response to Dynamic Load Change from 100% to 75% of Full Load ; $V_{in} = V_{in\ nom}$

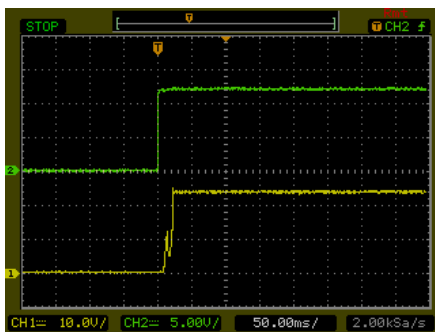

Typical Input Start-Up and Output Rise Characteristic
 $V_{in} = V_{in\ nom}$; Full Load

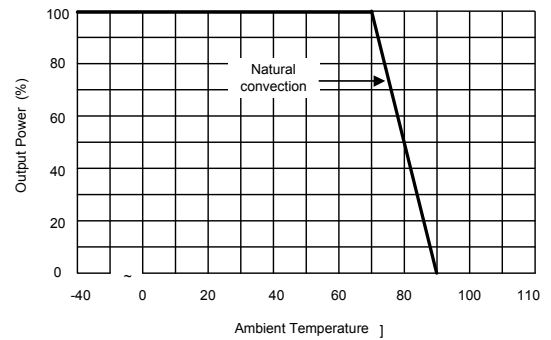

Derating Output Current Versus Ambient Temperature and Airflow

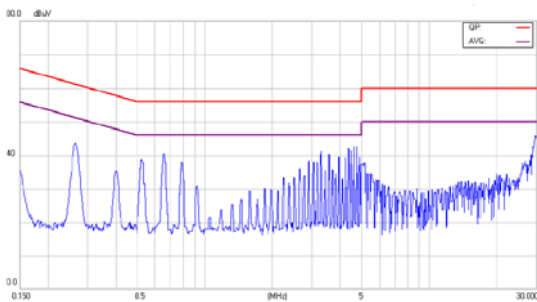

Conduction Emission of EN55022 Class B
 $V_{in} = V_{in\ nom}$; Full Load

Characteristic Curves

All test conditions are at 25°C. The figures are identical for THB 3-1222

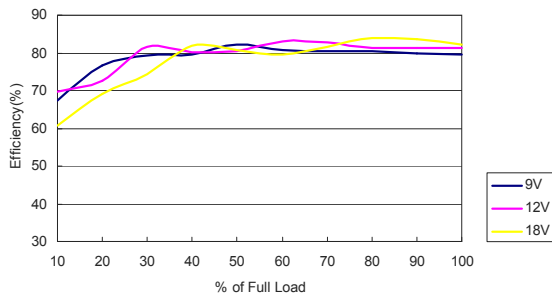

Efficiency Versus Output Current

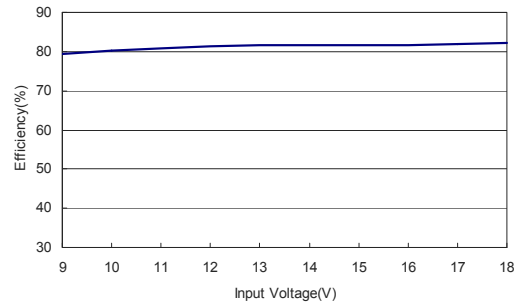

Efficiency Versus Input Voltage. Full Load

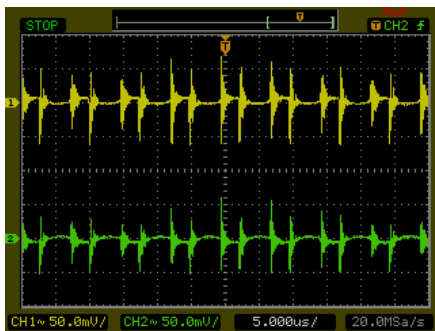

Typical Output Ripple and Noise.
 $V_{in} = V_{in\ nom}$; Full Load; T_A

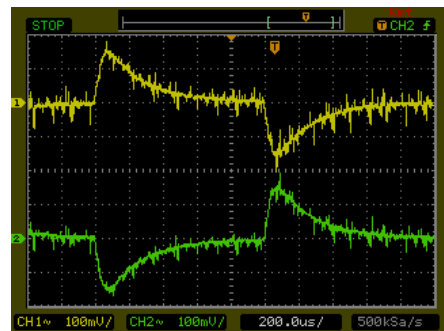

Transient Response to Dynamic Load Change from 100% to 75% of Full Load ; $V_{in} = V_{in\ nom}$

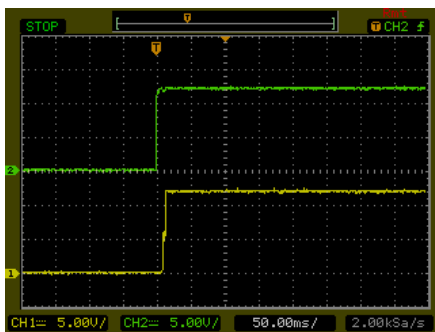

Typical Input Start-Up and Output Rise Characteristic
 $V_{in} = V_{in\ nom}$; Full Load

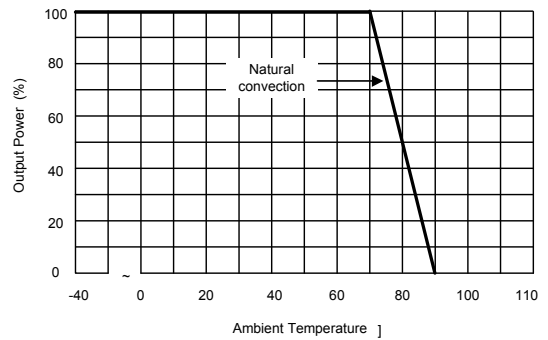

Derating Output Current Versus Ambient Temperature and Airflow

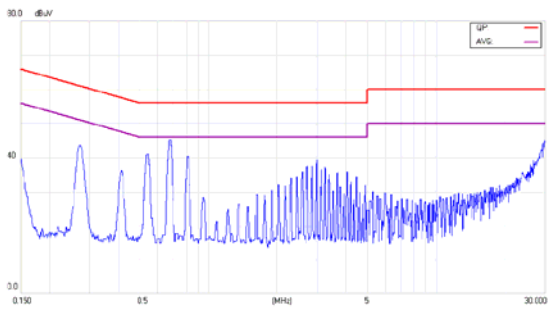

Conduction Emission of EN55022 Class B
 $V_{in} = V_{in\ nom}$; Full Load

Characteristic Curves

All test conditions are at 25°C. The figures are identical for THB 3-1223

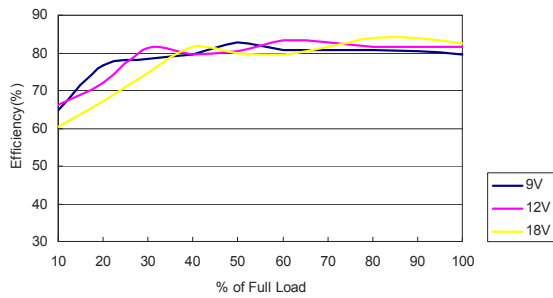

Efficiency Versus Output Current

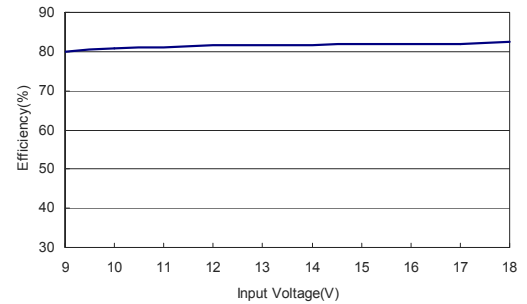

Efficiency Versus Input Voltage. Full Load

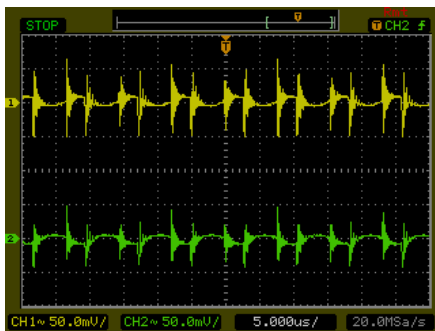

Typical Output Ripple and Noise.
 $V_{in} = V_{in\ nom}$; Full Load; T_A

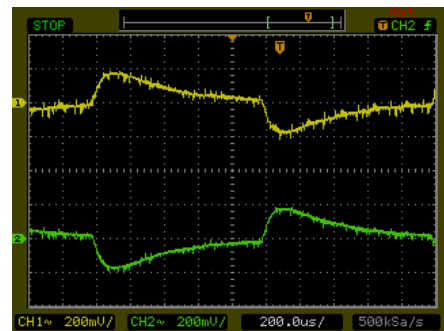

Transient Response to Dynamic Load Change from 100% to 75% of Full Load ; $V_{in} = V_{in\ nom}$

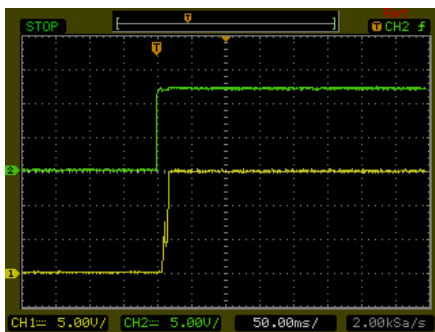

Typical Input Start-Up and Output Rise Characteristic
 $V_{in} = V_{in\ nom}$; Full Load

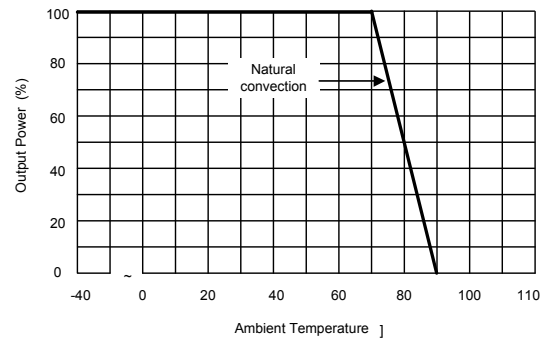

Derating Output Current Versus Ambient Temperature and Airflow

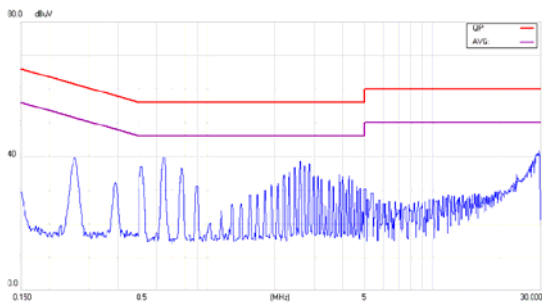

Conduction Emission of EN55022 Class B
 $V_{in} = V_{in\ nom}$; Full Load

Characteristic Curves

All test conditions are at 25°C. The figures are identical for THB 3-2411

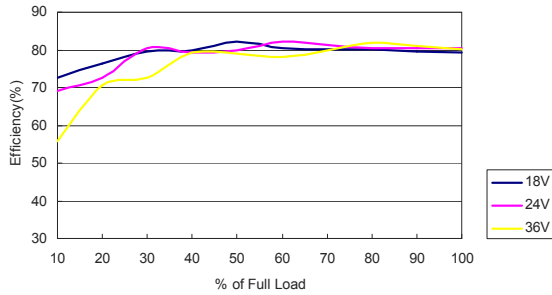

Efficiency Versus Output Current

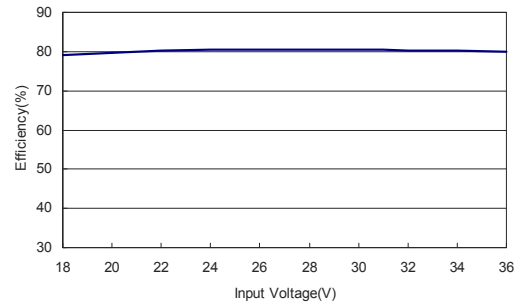

Efficiency Versus Input Voltage. Full Load

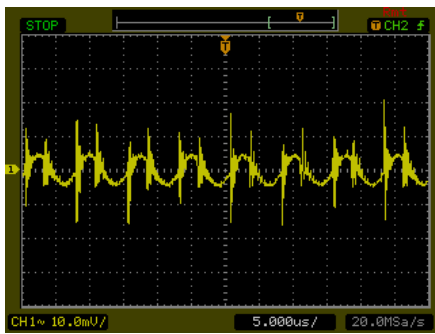

Typical Output Ripple and Noise.
 $V_{in} = V_{in\ nom}$; Full Load; T_A

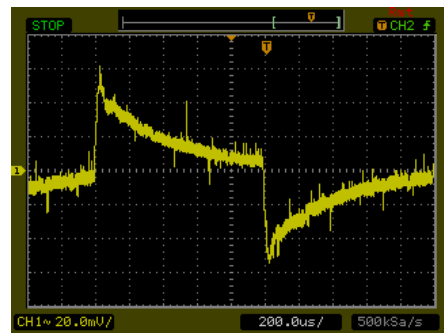

Transient Response to Dynamic Load Change from 100% to 75% of Full Load ; $V_{in} = V_{in\ nom}$

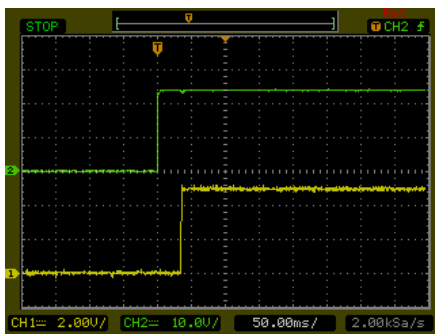

Typical Input Start-Up and Output Rise Characteristic
 $V_{in} = V_{in\ nom}$; Full Load

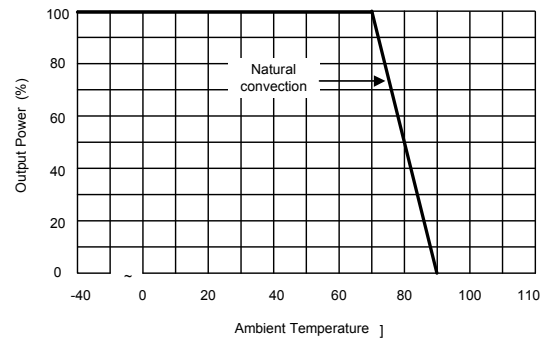

Derating Output Current Versus Ambient Temperature and Airflow

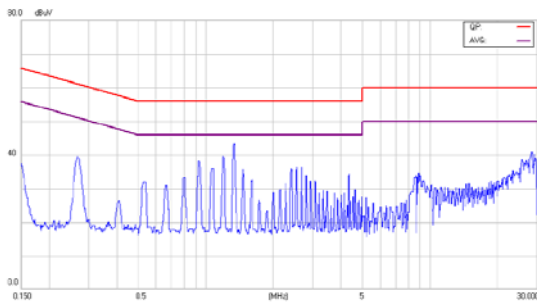

Conduction Emission of EN55022 Class B
 $V_{in} = V_{in\ nom}$; Full Load

Characteristic Curves

All test conditions are at 25°C. The figures are identical for THB 3-2412

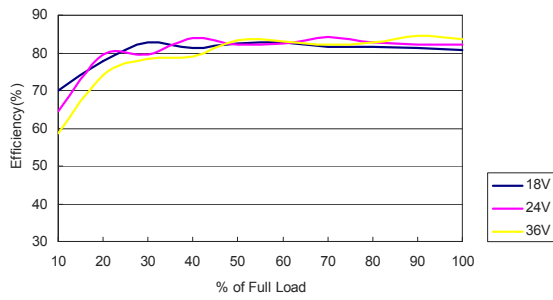

Efficiency Versus Output Current

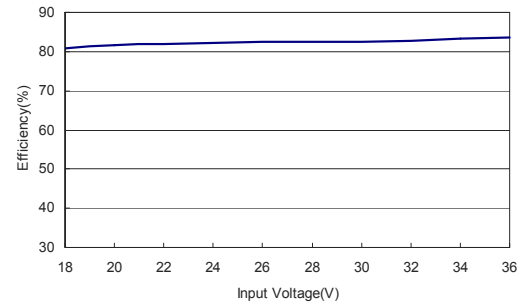

Efficiency Versus Input Voltage. Full Load

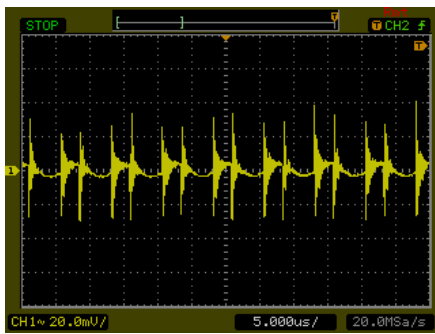

Typical Output Ripple and Noise.
 $V_{in} = V_{in\ nom}$; Full Load; T_A

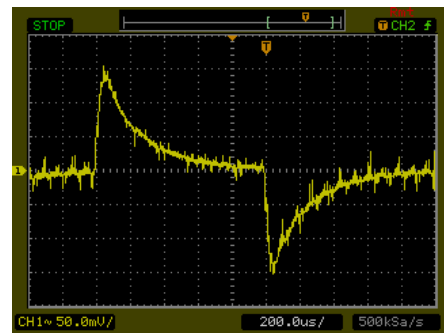

Transient Response to Dynamic Load Change from 100% to 75% of Full Load ; $V_{in} = V_{in\ nom}$

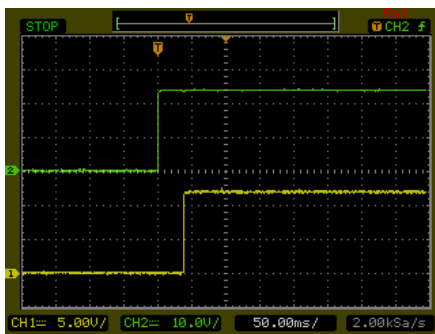

Typical Input Start-Up and Output Rise Characteristic
 $V_{in} = V_{in\ nom}$; Full Load

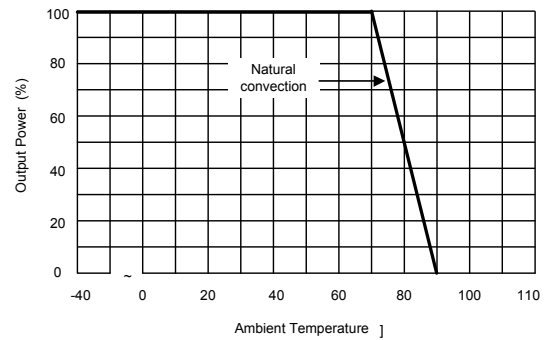

Derating Output Current Versus Ambient Temperature and Airflow

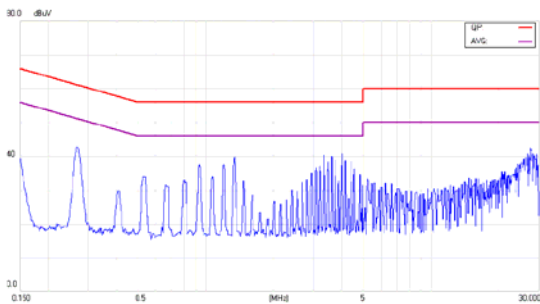

Conduction Emission of EN55022 Class B
 $V_{in} = V_{in\ nom}$; Full Load

Characteristic Curves

All test conditions are at 25°C. The figures are identical for THB 3-2415

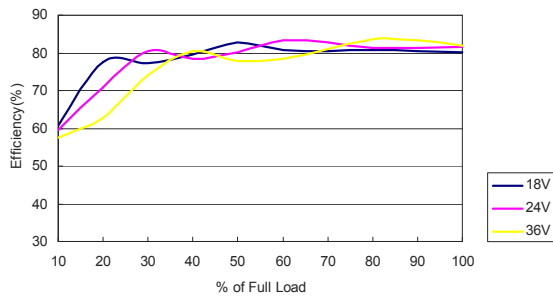

Efficiency Versus Output Current

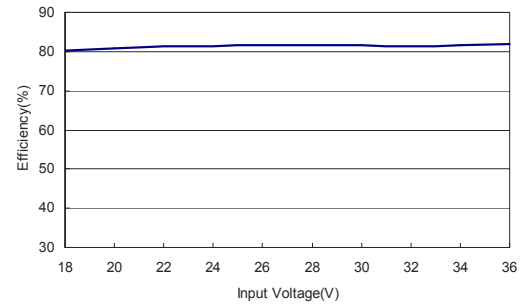

Efficiency Versus Input Voltage. Full Load



Typical Output Ripple and Noise.
 $V_{in} = V_{in\ nom}$; Full Load; T_A

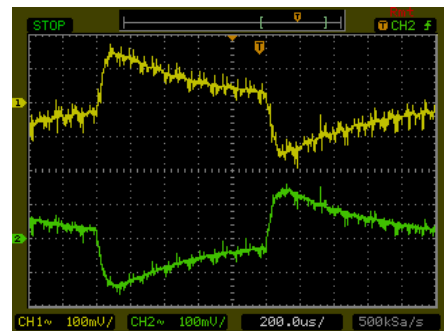

Transient Response to Dynamic Load Change from 100% to 75% of Full Load ; $V_{in} = V_{in\ nom}$

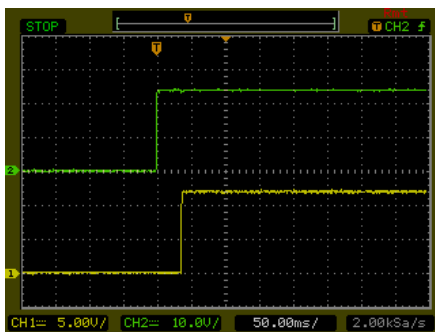

Typical Input Start-Up and Output Rise Characteristic
 $V_{in} = V_{in\ nom}$; Full Load

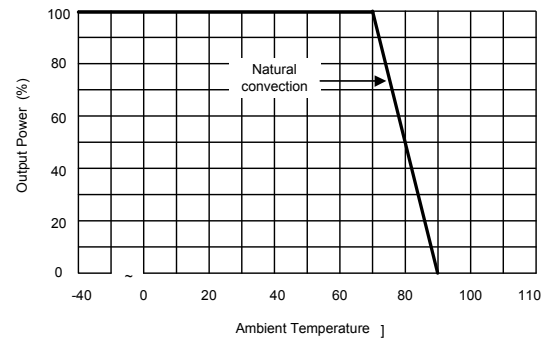

Derating Output Current Versus Ambient Temperature and Airflow

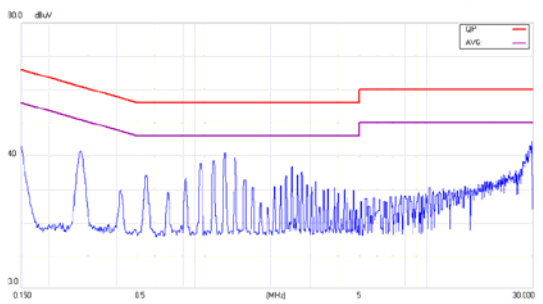

Conduction Emission of EN55022 Class B
 $V_{in} = V_{in\ nom}$; Full Load

Characteristic Curves

All test conditions are at 25°C. The figures are identical for THB 3-2422

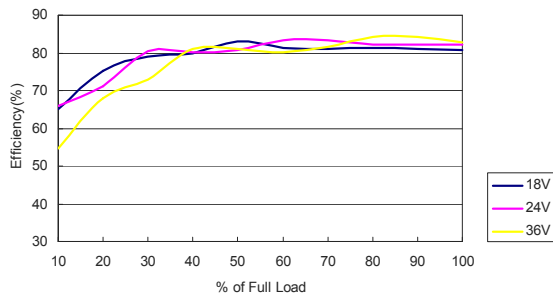

Efficiency Versus Output Current

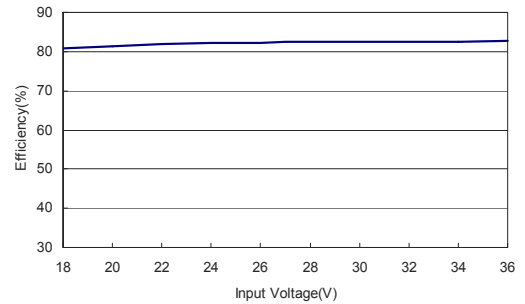

Efficiency Versus Input Voltage. Full Load

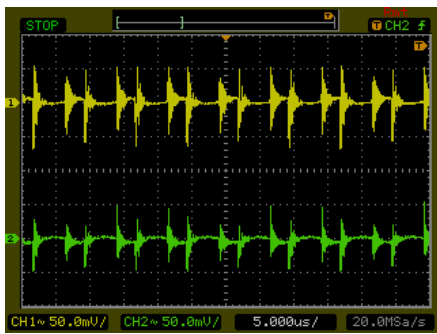

Typical Output Ripple and Noise.
 $V_{in} = V_{in\ nom}$; Full Load; T_A

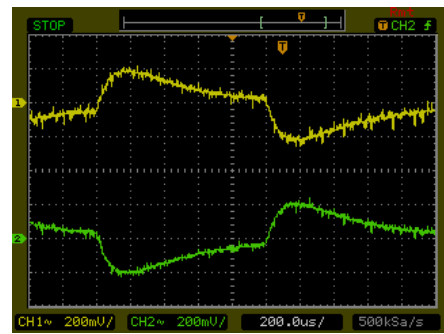

Transient Response to Dynamic Load Change from 100% to 75% of Full Load ; $V_{in} = V_{in\ nom}$

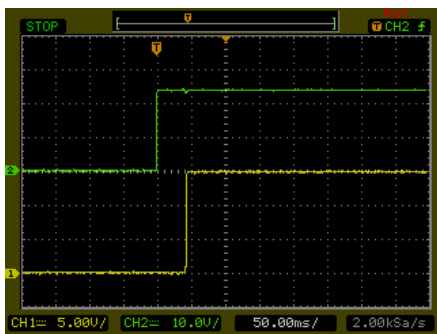

Typical Input Start-Up and Output Rise Characteristic
 $V_{in} = V_{in\ nom}$; Full Load

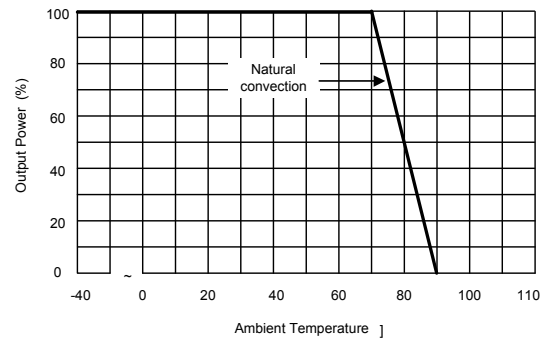

Derating Output Current Versus Ambient Temperature and Airflow

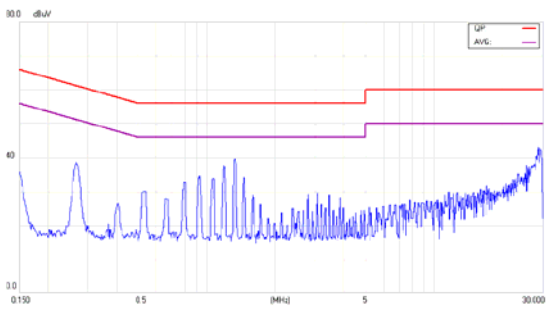

Conduction Emission of EN55022 Class B
 $V_{in} = V_{in\ nom}$; Full Load

Characteristic Curves

All test conditions are at 25°C. The figures are identical for THB 3-4811

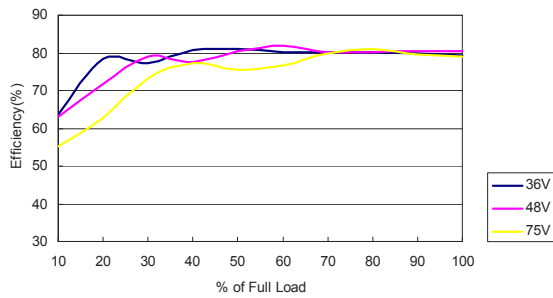

Efficiency Versus Output Current

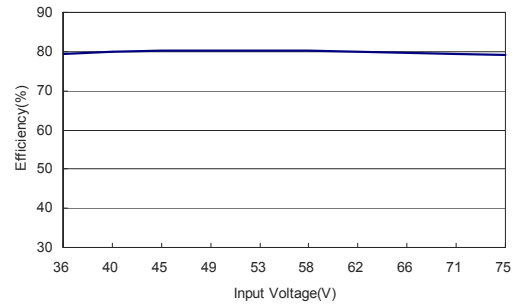

Efficiency Versus Input Voltage. Full Load

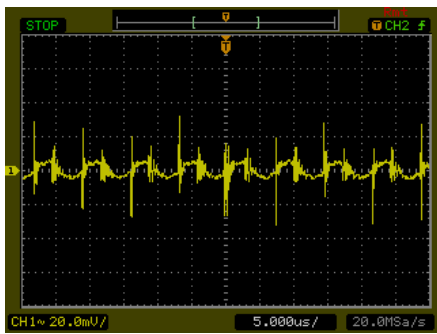

Typical Output Ripple and Noise.
 $V_{in} = V_{in\ nom}$; Full Load; T_A

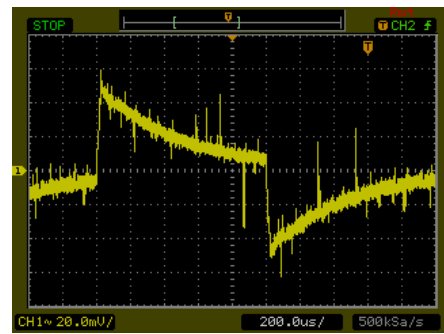

Transient Response to Dynamic Load Change from 100% to 75% of Full Load ; $V_{in} = V_{in\ nom}$

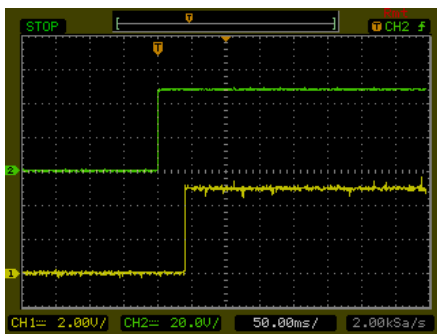

Typical Input Start-Up and Output Rise Characteristic
 $V_{in} = V_{in\ nom}$; Full Load

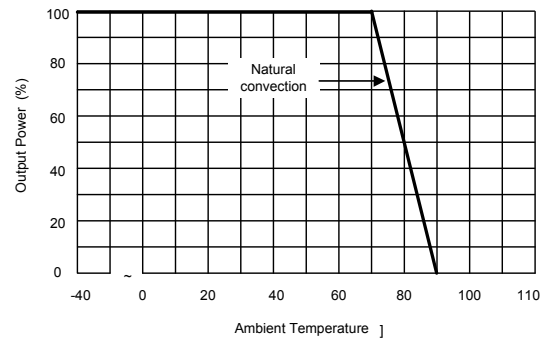

Derating Output Current Versus Ambient Temperature and Airflow

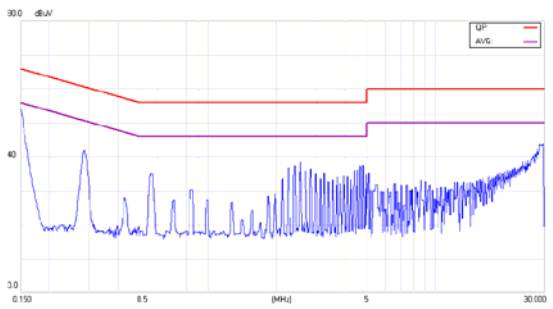

Conduction Emission of EN55022 Class B
 $V_{in} = V_{in\ nom}$; Full Load

Characteristic Curves

All test conditions are at 25°C. The figures are identical for THB 3-4812

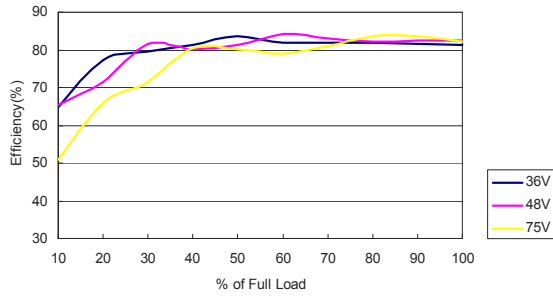

Efficiency Versus Output Current

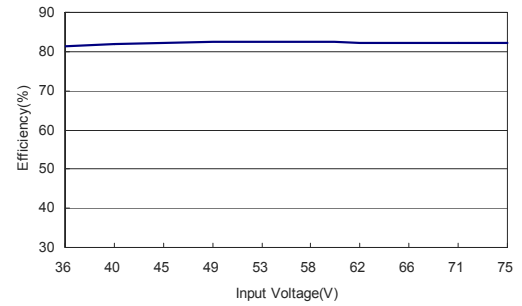

Efficiency Versus Input Voltage. Full Load

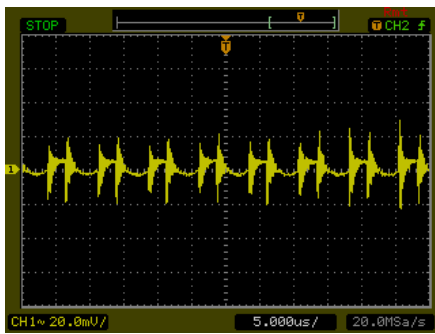

Typical Output Ripple and Noise.
 $V_{in} = V_{in\ nom}$; Full Load; T_A

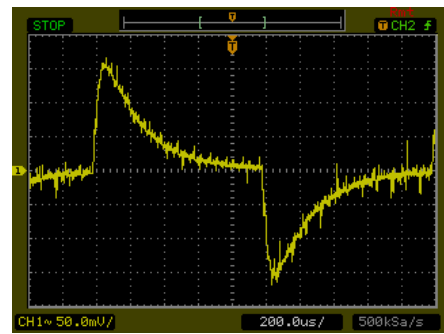

Transient Response to Dynamic Load Change from 100% to 75% of Full Load ; $V_{in} = V_{in\ nom}$

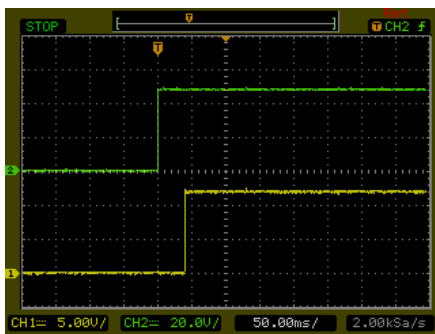

Typical Input Start-Up and Output Rise Characteristic
 $V_{in} = V_{in\ nom}$; Full Load

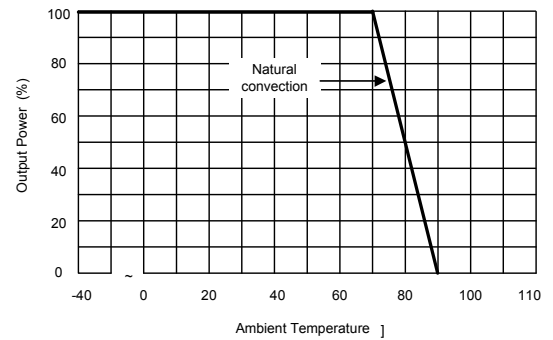

Derating Output Current Versus Ambient Temperature and Airflow

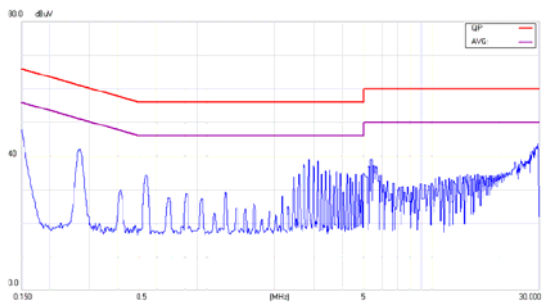

Conduction Emission of EN55022 Class B
 $V_{in} = V_{in\ nom}$; Full Load

Characteristic Curves

All test conditions are at 25°C. The figures are identical for THB 3-4815

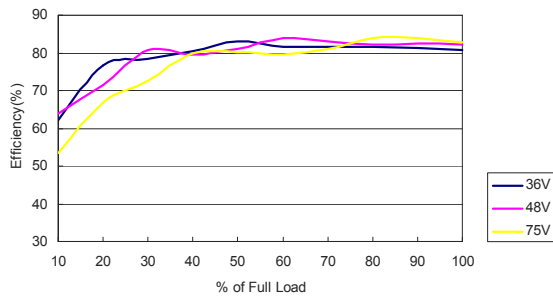

Efficiency Versus Output Current

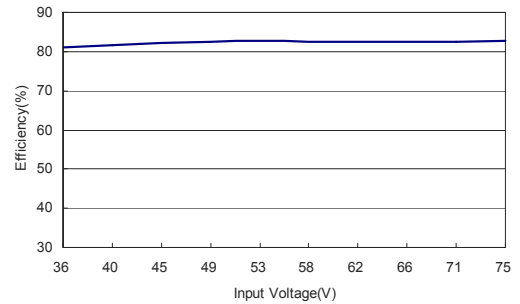

Efficiency Versus Input Voltage. Full Load

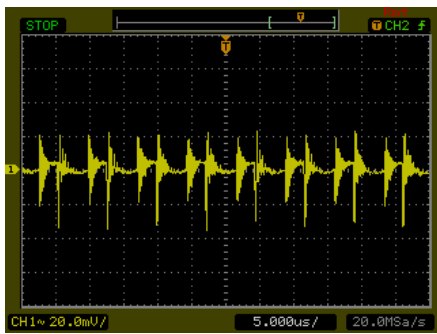

Typical Output Ripple and Noise.
 $V_{in} = V_{in\ nom}$; Full Load; T_A

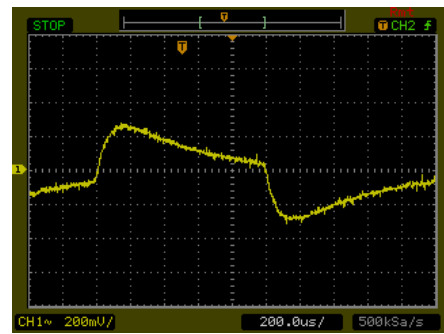

Transient Response to Dynamic Load Change from 100% to 75% of Full Load ; $V_{in} = V_{in\ nom}$

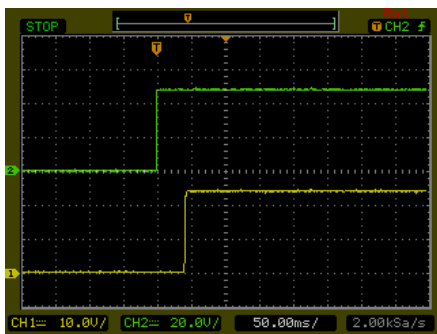

Typical Input Start-Up and Output Rise Characteristic
 $V_{in} = V_{in\ nom}$; Full Load

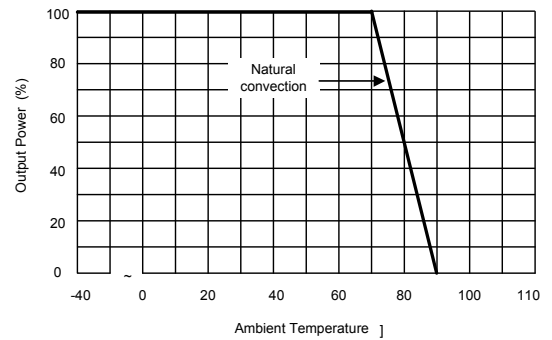

Derating Output Current Versus Ambient Temperature and Airflow

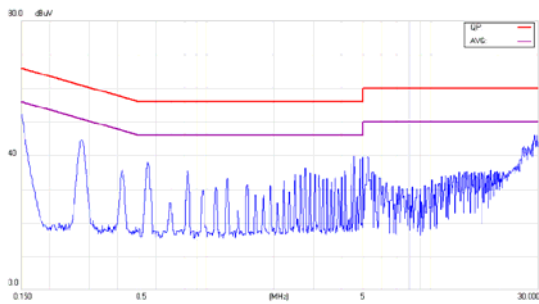

Conduction Emission of EN55022 Class B
 $V_{in} = V_{in\ nom}$; Full Load

Characteristic Curves

All test conditions are at 25°C. The figures are identical for THB 3-4822

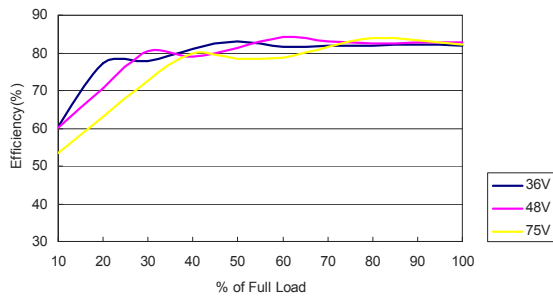

Efficiency Versus Output Current

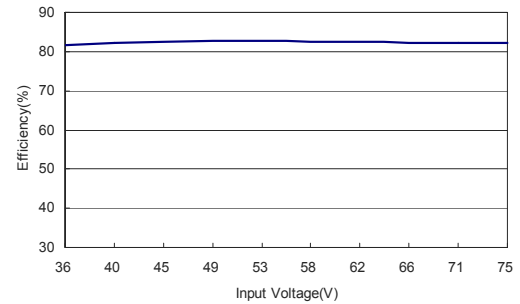

Efficiency Versus Input Voltage. Full Load

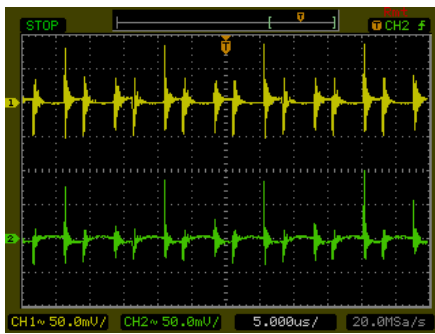

Typical Output Ripple and Noise.
 $V_{in} = V_{in\ nom}$; Full Load; T_A

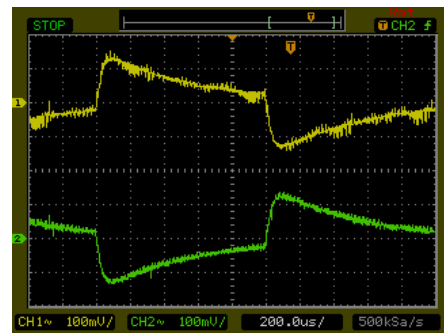

Transient Response to Dynamic Load Change from 100% to 75% of Full Load ; $V_{in} = V_{in\ nom}$

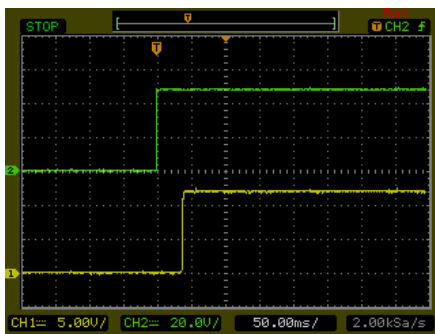

Typical Input Start-Up and Output Rise Characteristic
 $V_{in} = V_{in\ nom}$; Full Load

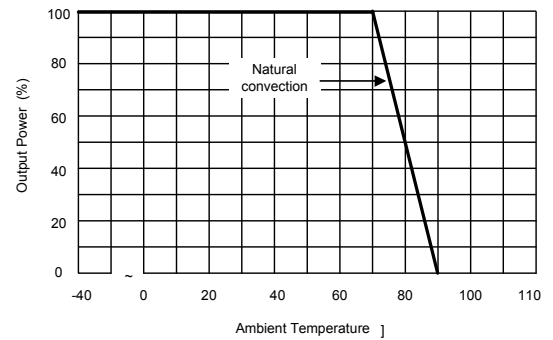

Derating Output Current Versus Ambient Temperature and Airflow

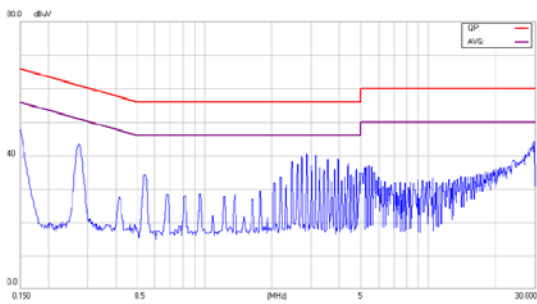

Conduction Emission of EN55022 Class B
 $V_{in} = V_{in\ nom}$; Full Load

Characteristic Curves

All test conditions are at 25°C. The figures are identical for THB 3-4823

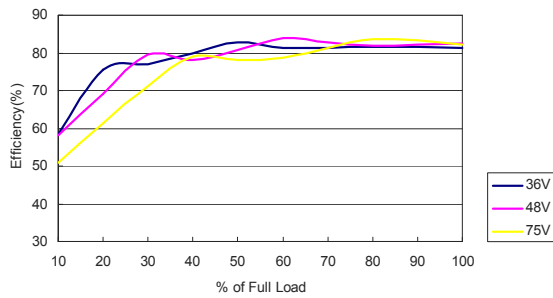

Efficiency Versus Output Current

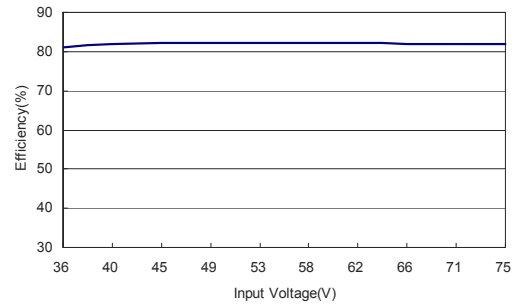

Efficiency Versus Input Voltage. Full Load

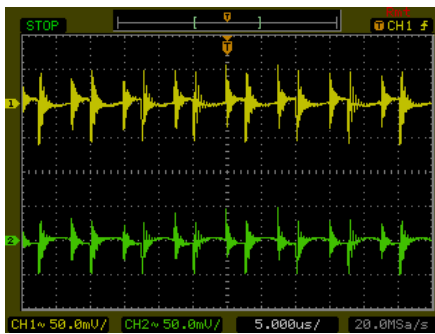

Typical Output Ripple and Noise.
 $V_{in} = V_{in\ nom}$; Full Load; T_A

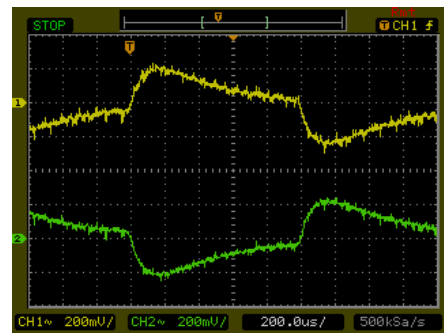

Transient Response to Dynamic Load Change from 100% to 75% of Full Load ; $V_{in} = V_{in\ nom}$

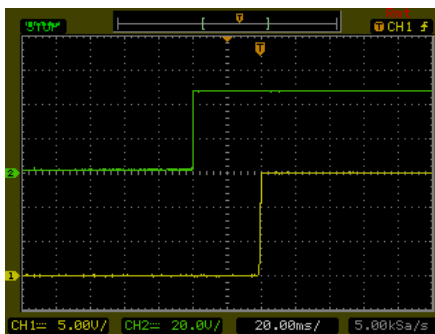

Typical Input Start-Up and Output Rise Characteristic
 $V_{in} = V_{in\ nom}$; Full Load

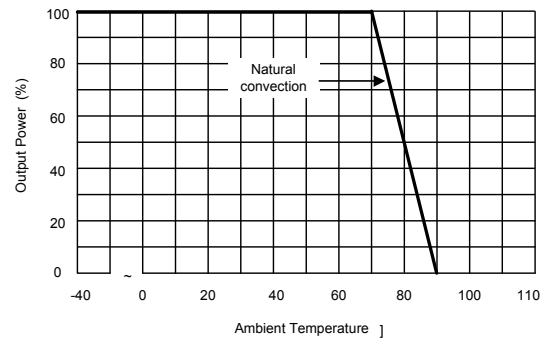

Derating Output Current Versus Ambient Temperature and Airflow

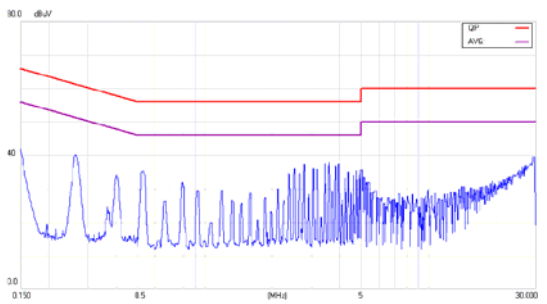

Conduction Emission of EN55022 Class B
 $V_{in} = V_{in\ nom}$; Full Load

Testing Configurations

Input reflected-ripple current measurement test set up

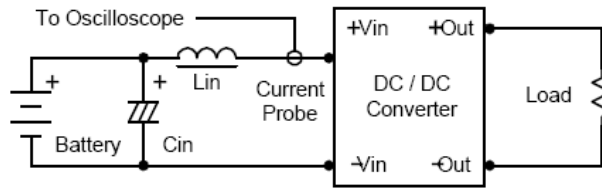

Component	Value	Reference
L	4.7μH	-----
C	220μF (ESR<1.0Ω at 100KHz)	Aluminum Electrolytic Capacitor

Peak-to-peak output ripple & noise measurement test set up

Use a Cout 0.47μF ceramic capacitor. Scope measurement should be made by using a BNC socket, measurement bandwidth is 0-20 MHz. Position the load between 50mm and 75mm from the DC/DC Converter.

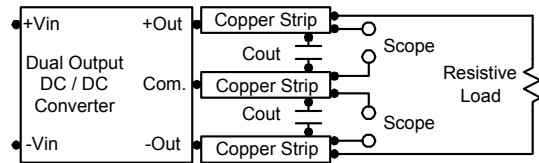
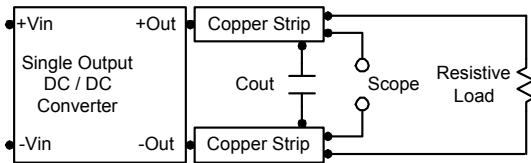

Output voltage and efficiency measurement test set up

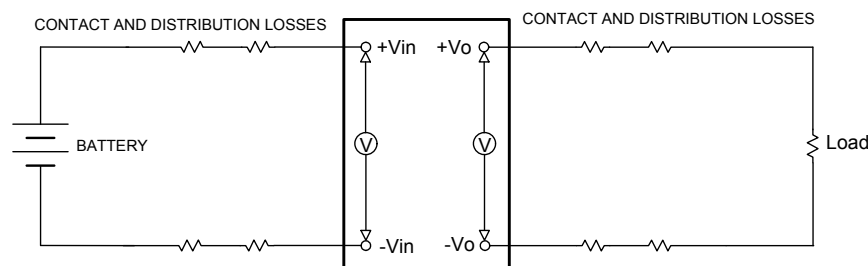

$$Efficiency = \left(\frac{V_{out} \times I_{out}}{V_{in} \times I_{in}} \right) \times 100\% = [\%]$$

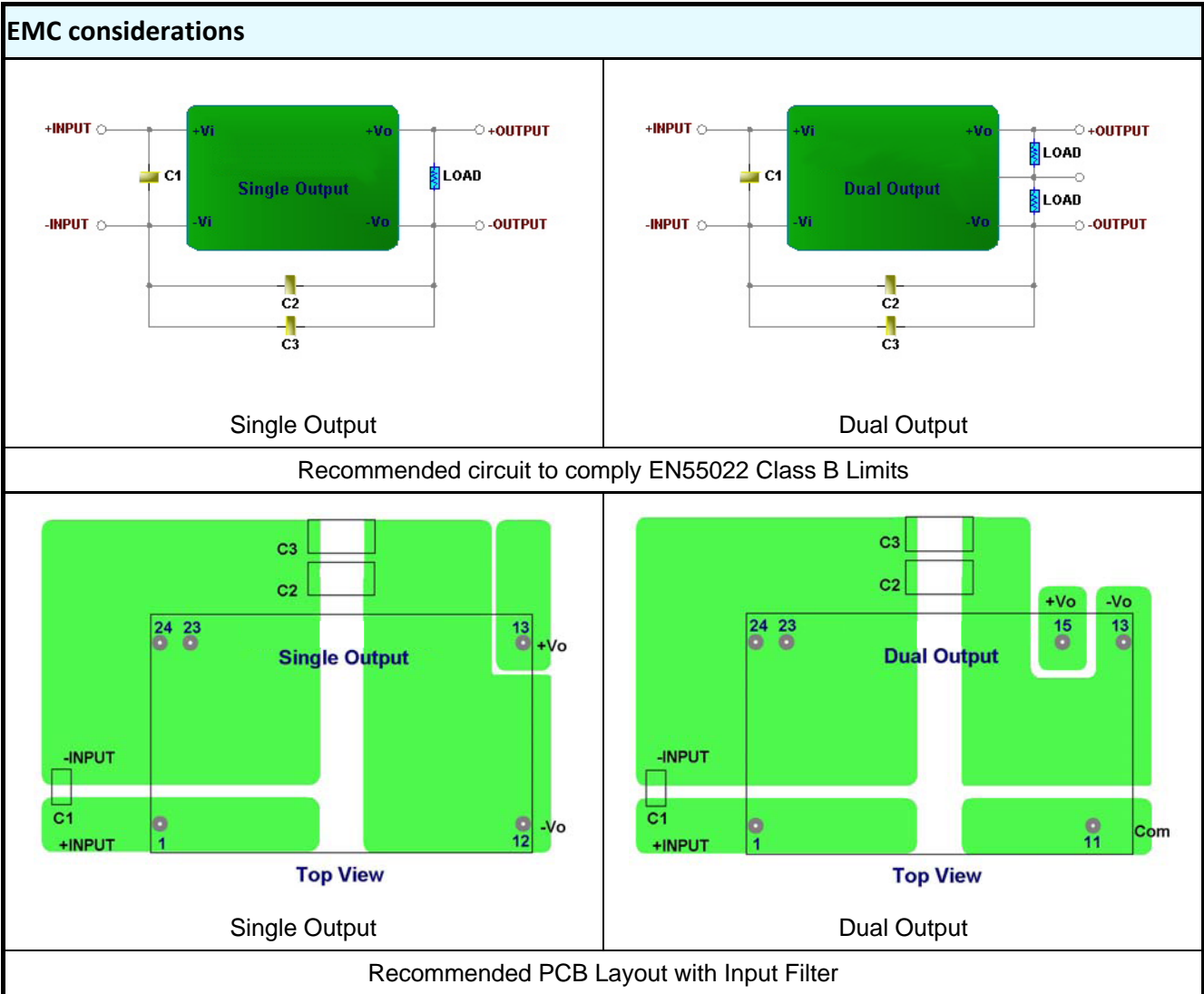

To: comply with EN55022 CLASS B following components are recommended:

Model	Component	Value
THB 3-05xx	C1	22µF/16V 1206 MLCC
	C2 & C3	100pF/6KV 2211 MLCC
THB 3-12xx	C1	4.7µF/25V 1206 MLCC
	C2 & C3	100pF/6KV 2211 MLCC
THB 3-24xx	C1	2.2µF/50V 1206 MLCC
	C2 & C3	100pF/6KV 2211 MLCC
THB 3-48xx	C2 & C3	100pF/6KV 2211 MLCC

Input Source Impedance

The power module should be connected to a low ac-impedance input source. Highly inductive source impedances can affect the stability of the power module. In applications where power is supplied over long lines and output loading is high, it may be necessary to use a capacitor on the input to insure startup. Capacitor mounted close to the power module helps ensure stability of the unit, it is recommended to use a good quality low Equivalent Series Resistance ($ESR < 1.0\ \Omega$ at 100 kHz) capacitor of a $10\ \mu\text{F}$ for the 5V input devices and a $4.7\ \mu\text{F}$ for the 12V input devices.

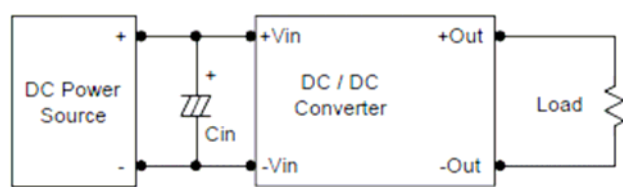

Short Circuitry Protection

Continuous, hiccup and auto-recovery mode.

During short circuit, converter still shut down, The average current during this condition will be very low and the device will be safe in this condition.

Thermal Consideration

The converter is designed to operate in a variety of thermal environments and sufficient cooling must be provided to ensure reliable operation. Heat is removed by conduction from the pins to the PCB board, and by convection through airflow across the converter. Proper cooling can be verified by measuring the point as the figure below. The temperature at this location should not exceed 95°C . When operating, adequate cooling must be provided to maintain the test point temperature at or below 95°C . Although the maximum point temperature of the power module is 95°C , you can limit this temperature to a lower value for extremely high reliability.

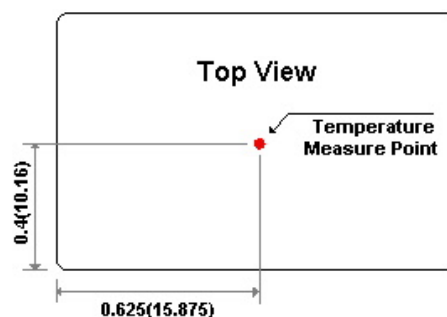

Measurement shown in inches(mm)

Mechanical Dimensions

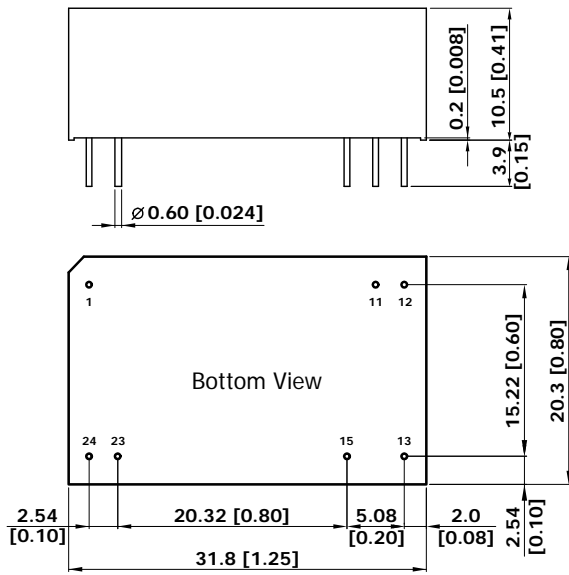

Pin Connections		
Pin	Single Output	Dual Output
1	+Vin	+Vin
11	No Pin	Common
12	-Vout	No Pin
13	+Vout	-Vout
15	No Pin	+Vout
23	-Vin	-Vin
24	-Vin	-Vin

1. All dimensions in mm (inches)
Tolerance: X.X ± 0.25 (X.XX ± 0.01 ")
X.XX ± 0.13 (X.XXX ± 0.005 ")
2. Pin pitch tolerance: ± 0.25 (± 0.01 ")
3. Pin dimension tolerance: ± 0.1 (± 0.004 ")

Weight: 16.2g

Recommended Pad Layout for Single & Dual Output Converter

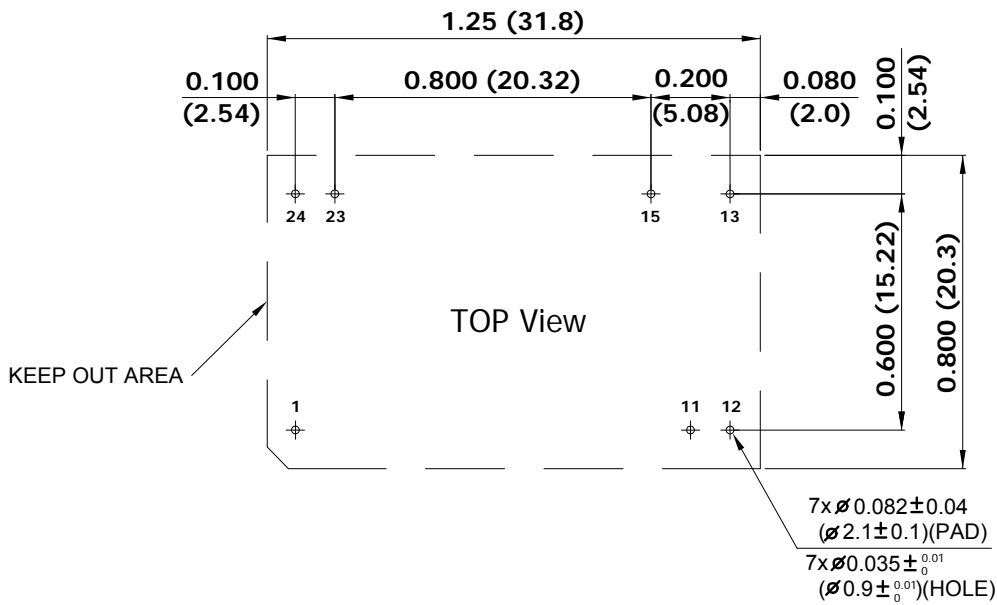

1. All dimensions in Inches (mm)
Tolerance: x.xx ± 0.02 " (x.x ± 0.5 mm)
x.xxx ± 0.01 " (x.xx ± 0.25 mm)
2. Pin pitch tolerance: ± 0.01 " (± 0.25 mm)

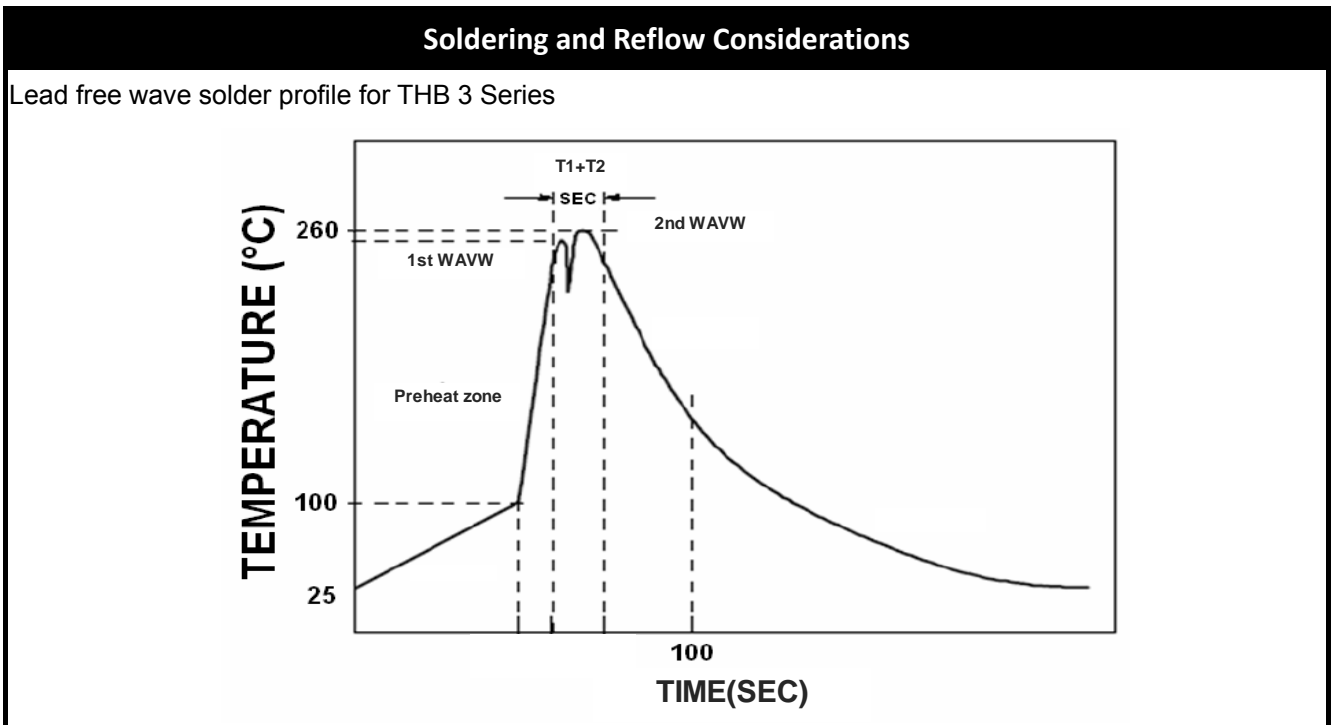
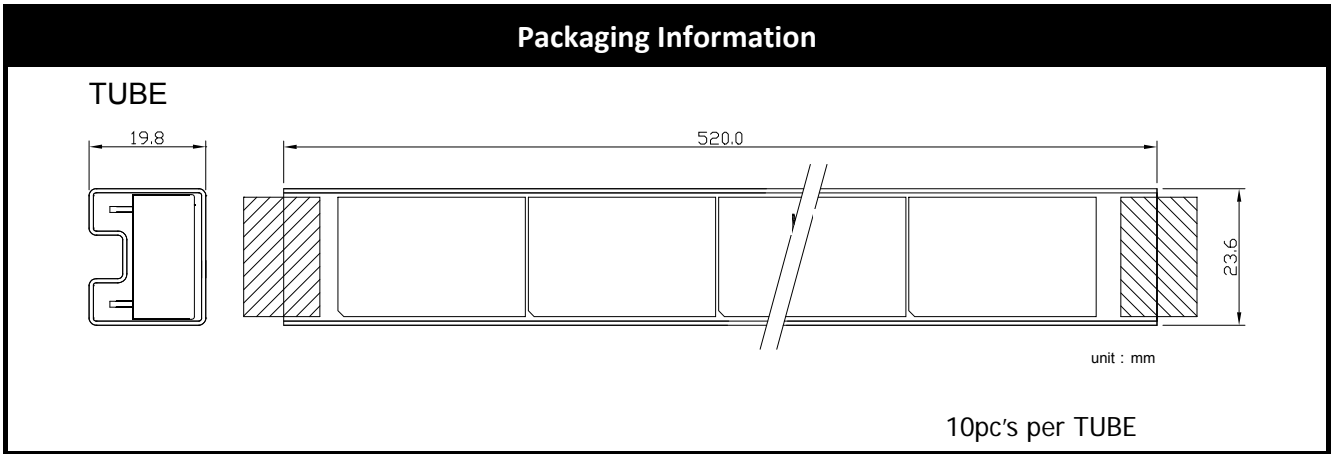

Part Number

Model Number	Input Range (Vdc)	Output Voltage (Vdc)	Max. Output Current (mA)	Input Current at Full Load ⁽¹⁾ (mA)	Efficiency ⁽²⁾ (%)
THB 3-0511	4.5 – 9	5	600	857	70
THB 3-0512	4.5 – 9	12	250	800	75
THB 3-0515	4.5 – 9	24	125	800	76
THB 3-0522	4.5 – 9	±12	±125	800	75
THB 3-0523	4.5 – 9	±15	±100	800	75
THB 3-1211	9 – 18	5	600	338	74
THB 3-1212	9 – 18	12	250	313	80
THB 3-1215	9 – 18	24	125	313	81
THB 3-1222	9 – 18	±12	±125	313	80
THB 3-1223	9 – 18	±15	±100	313	80
THB 3-2411	18 – 36	5	600	160	78
THB 3-2412	18 – 36	12	250	151	83
THB 3-2415	18 – 36	24	125	151	84
THB 3-2422	18 – 36	±12	±125	151	83
THB 3-2423	18 – 36	±15	±100	151	83
THB 3-4811	36 – 75	5	600	80	78
THB 3-4812	36 – 75	12	250	75	83
THB 3-4815	36 – 75	24	125	75	84
THB 3-4822	36 – 75	±12	±125	75	83
THB 3-4823	36 – 75	±15	±100	75	83

Note 1. Maximum value at nominal input voltage and full load of standard type.

Note 2. Typical value at nominal input voltage and full load.

Safety and Installation Instruction

Fusing Consideration

Caution: This power module is not internally fused. An input line fuse must always be used. This encapsulated power module can be used in a wide variety of applications, ranging from simple stand-alone operation to an integrated part of sophisticated power architecture. To maximum flexibility, internal fusing is not included; however, to achieve maximum safety and system protection, always use an input line fuse. The safety agencies require a normal-blow fuse in 5V_{in}, 12V_{in}, 24V_{in}, 48V_{in} with maximum rating of 2000mA, 1000mA, 500mA, 250mA. Based on the information provided in this data sheet on Inrush energy and maximum dc input current; the same type of fuse with lower rating can be used. Refer to the fuse manufacturer's data for further information.

MTBF and Reliability

The MTBF of THB 3 series of DC/DC converters has been calculated using MIL-HDBK 217F

Operating Temperature 25°C, Ground Benign.

Model	MTBF	Unit
THB 3-0511	1,077,238	Hours
THB 3-0512	1,167,270	Hours
THB 3-0515	1,164,415	Hours
THB 3-0522	1,158,078	Hours
THB 3-0523	1,166,045	Hours
THB 3-1211	1,069,519	Hours
THB 3-1212	1,115,325	Hours
THB 3-1215	1,108,033	Hours
THB 3-1222	1,102,293	Hours
THB 3-1223	1,096,491	Hours
THB 3-2411	1,035,518	Hours
THB 3-2412	1,091,941	Hours
THB 3-2415	1,077,818	Hours
THB 3-2422	1,072,386	Hours
THB 3-2423	1,066,212	Hours
THB 3-4811	1,037,237	Hours
THB 3-4812	1,085,423	Hours
THB 3-4815	1,070,435	Hours
THB 3-4822	1,066,212	Hours
THB 3-4823	1,066,212	Hours