

953 Series ST Connectors

Amphenol's 953 Series fiber optic ST and ST II connectors utilize a bayonet style mating concept to provide a secure, robust coupling mechanism. The enclosed spiral slotted coupling nut allows easy insertion in densely packed patch panels.

The ST connector has been used extensively in telecom, data premise installation, and test lab applications. Special attention has been given to every ST performance parameter, increasing product repeatability and exceeding industry standards. The ST connector is available with a plastic or die cast body with a ceramic or stainless steel ferrule.



Features/Benefits

- The ST connector body and coupling nut are precision molded with a flame retardant polymer for a durable and light weight product
- The STII connector body and coupling nut are precision zinc die cast and nickel plated for superior strength and corrosion resistance
- High precision zirconia ferrules minimize insertion loss and return loss values
- Available in singlemode and multimode versions
- Available with 900 μ m, 2.0mm, or 3.0mm boots
- Stainless steel ferrules also available on both the ST and ST II connectors

Specifications

Insertion Loss: ≤ 0.15 dB typical, singlemode
 ≤ 0.35 dB typical, multimode

Return Loss: Ultra (UPC) ≤ -55 dB*

Durability: < 0.2 dB change, 500mating cycles

Temperature: < 0.3 dB change, -40 to +85°C

Intermateability:

The Amphenol 953 Series ST Connectors are mechanically and optically intermateable with NTT-FC type products and conform to TIA/EIA and IEC specifications.

*Performance is polish dependent

953 Series ST Connector Ordering Information*

ST II Connectors with Ceramic Ferrules		Ferrule Hole Size	Body and Nut Material	Recommended Cable Diameter	Boot Color
Part #	Description				
953-101-5306-P	ST II Connector, Singlemode, 126µm Zirconia Ferrule	126µm	Die-cast	3mm or 900µm	Black
953-101-5310-P	ST II Connector, Multimode, 128µm Zirconia Ferrule	128µm	Die-cast	3mm or 900µm	Black
953-101-5316-P	ST II Connector, Singlemode, 126µm Zirconia Ferrule	126µm	Die-cast	2mm	Black
953-101-5309-P	ST II Connector, Multimode, 128µm Zirconia Ferrule	128µm	Die-cast	2mm	Black
ST II Connectors with Stainless Steel Ferrules		Ferrule Hole Size	Body and Nut Material	Recommended Cable Diameter	Boot Color
Part #	Description				
953-106-50128-P	ST II Connector, Multimode, 128µm Stainless Steel Ferrule	128µm	Die-cast	3mm or 900µm	Black
953-106-50144-P	ST II Connector, Multimode, 144µm Stainless Steel Ferrule	144µm	Die-cast	3mm or 900µm	Black
953-106-50231-P	ST II Connector, Multimode, 231µm Stainless Steel Ferrule	231µm	Die-cast	3mm or 900µm	Black
ST Connectors with Ceramic Ferrules		Ferrule Hole Size	Body and Nut Material	Recommended Cable Diameter	Boot Color
Part #	Description				
953-101-5006-P	ST Connector, Singlemode, 126µm Zirconia Ferrule	126µm	Plastic	3mm or 900µm	Black
953-101-5010-P	ST Connector, Multimode, 128µm Zirconia Ferrule	128µm	Plastic	3mm or 900µm	Black
ST Connectors with Stainless Steel Ferrules		Ferrule Hole Size	Body and Nut Material	Recommended Cable Diameter	Boot Color
Part #	Description				
953-107-50128-P	ST Connector, Multimode, 128µm Stainless Steel Ferrule	128µm	Plastic	3mm or 900µm	Black
953-107-50144-P	ST Connector, Multimode, 144µm Stainless Steel Ferrule	144µm	Plastic	3mm or 900µm	Black
953-107-50231-P	ST Connector, Multimode, 231µm Stainless Steel Ferrule	231µm	Plastic	3mm or 900µm	Black

* Please contact Amphenol for other configurations and custom hole sizes for the stainless steel ferrules.

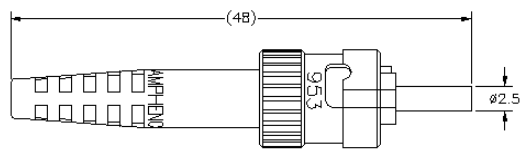

ST Connector with 3.0mm Boot

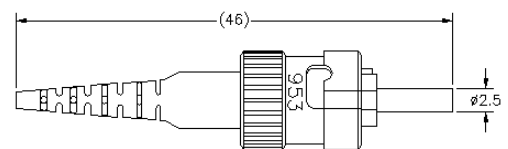

ST Connector with 900µm Boot

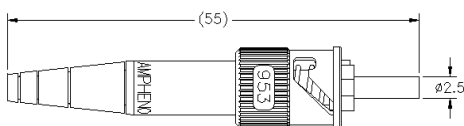

ST II Connector with 2.0mm Boot

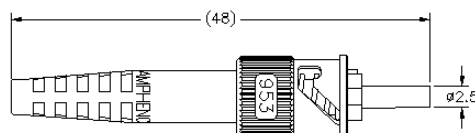

ST II Connector with 3.0mm Boot

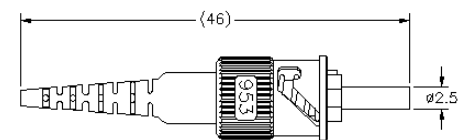

ST II Connector with 900µm Boot

ST Adapters

ST Adapters		Alignment Sleeve Material	Flange Type	Body
Part #	Description			
953-120-5000	ST adapter, plastic body, singlemode, D-hole	Zirconia	Feed-through, D-hole	Black Plastic
953-120-5003	ST adapter, metal body, singlemode, D-hole	Zirconia	Feed-through, D-hole	Metal
953-122-5000	ST adapter, plastic body, multimode, D-hole	Phosphor Bronze	Feed-through, D-hole	Beige Plastic
953-122-5003	ST adapter, metal body, multimode, D-hole	Phosphor Bronze	Feed-through, D-hole	Metal
ST Hybrid Adapters		Alignment Sleeve Material	Flange Type	Color
Part #	Description			
954-953-5000	SC-ST hybrid simplex adapter, singlemode	Zirconia	Screw mount	Blue/Black Plastic
954-953-5001	SC-ST hybrid simplex adapter, multimode	Phosphor Bronze	Screw mount	Blue/Black Plastic
ST Accessories				
Part #	Description			
953-1061	ST dust cap with chain, 0.130" diameter ring			
953-1079	ST dust cap with chain, 0.380" diameter ring			

* Please contact Amphenol for other configurations.

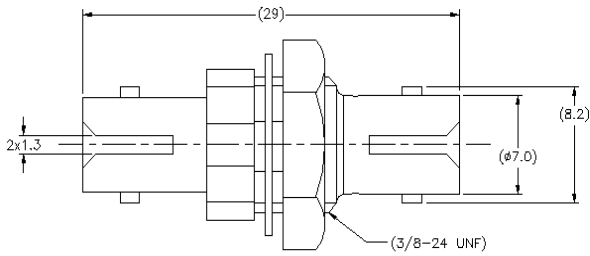

ST Plastic Adapter, Feed-through, D-Hole

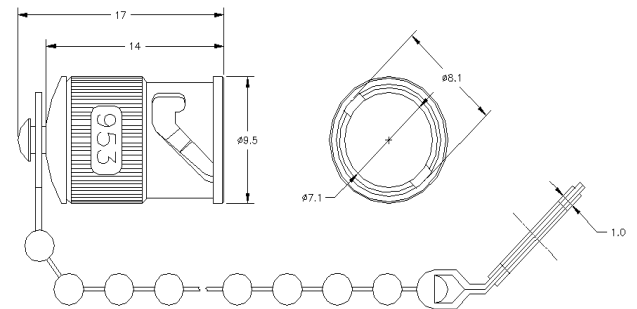

ST Dust Cap with Chain (953-1061)

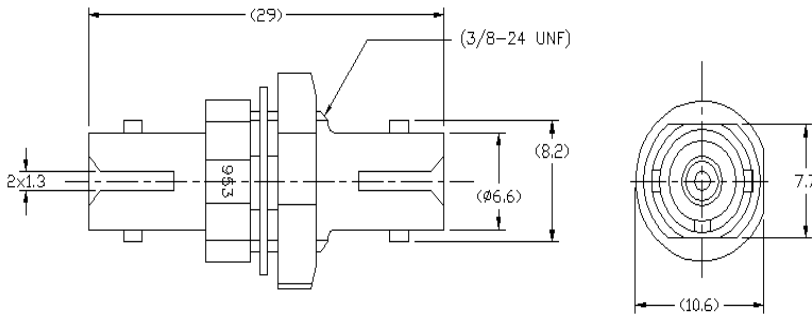

ST Metal Adapter, Feed-through, D-Hole